

**CONNECTOR  
 DESIGNATORS**  
**A-B\*-C-D-E-F**  
**G-H-J-K-L-S**

\* Conn. Desig. B See Note 5  
**DIRECT  
 COUPLING**

**TYPE C OVERALL  
 SHIELD TERMINATION**

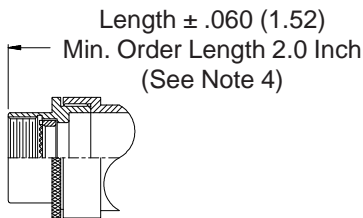
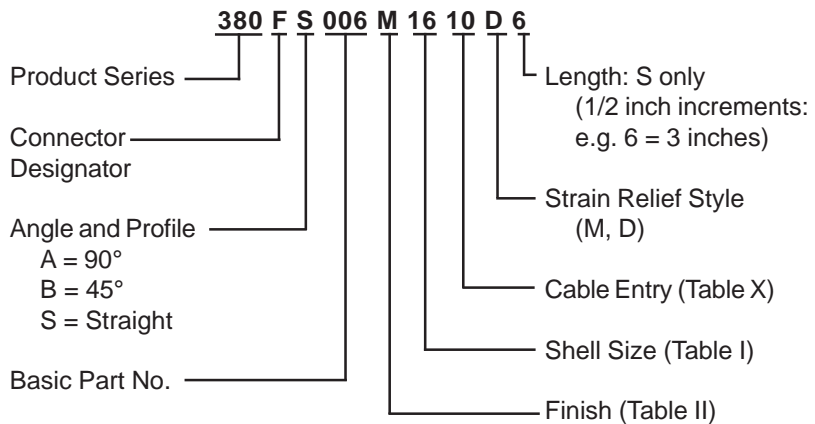

**STYLE 2  
 (STRAIGHT  
 See Note 1)**

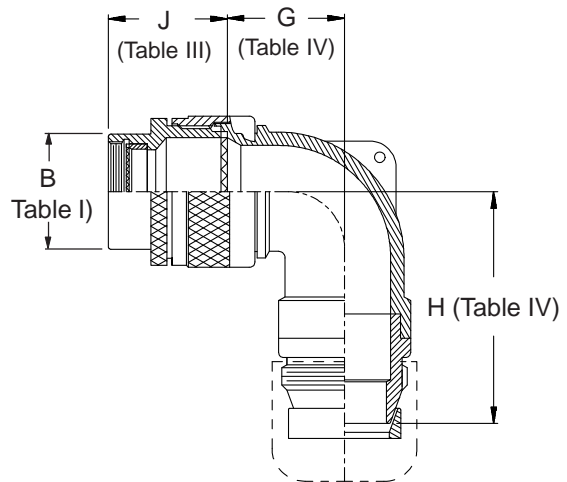
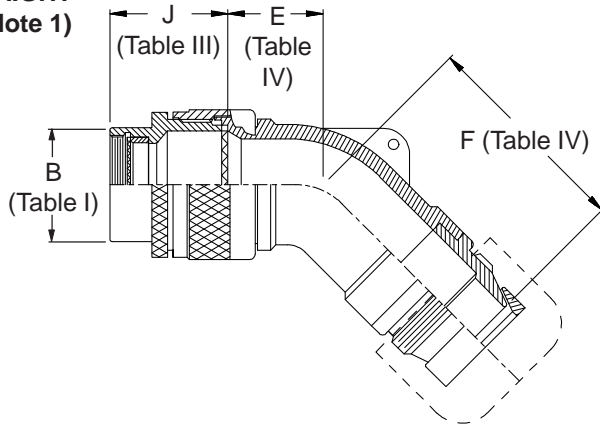
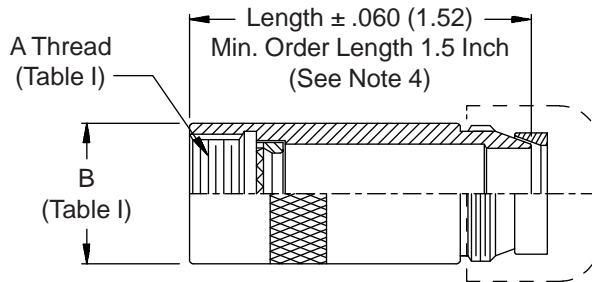

**STYLE M**  
 Medium Duty - Dash No. 01-04  
 (Table X)

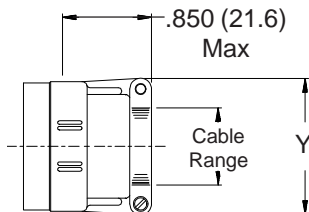

**STYLE M**  
 Medium Duty - Dash No. 10-28  
 (Table X)

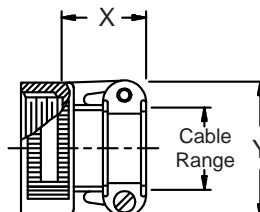

**STYLE D**  
 Medium Duty  
 (Table X)

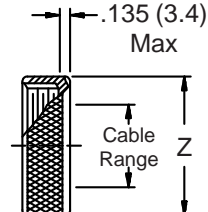

**380-006**  
**EMI/RFI Non-Environmental Backshell**  
**Heavy-Duty with Strain Relief**  
**Type C - Direct Coupling - Low Profile**



**TABLE III: FRONT ADAPTER**

Shell Size	J Max - Conn. Designator		
	A-E-F		
	J-H-L-S	D-B-G-K	C
08/09	1.180 (30.0)	1.440 (36.6)	
10/11	1.180 (30.0)	1.440 (36.6)	
12/13	1.180 (30.0)	1.440 (36.6)	1.735 (44.1)
14/15	1.180 (30.0)	1.440 (36.6)	1.915 (48.6)
16/17	1.380 (35.0)	1.560 (39.6)	1.915 (48.6)
18/19	1.380 (35.0)	1.560 (39.6)	1.915 (48.6)
20/21	1.380 (35.0)	1.560 (39.6)	1.915 (48.6)
22/23	1.380 (35.0)	1.560 (39.6)	1.915 (48.6)
24/25	1.380 (35.0)	1.560 (39.6)	1.915 (48.6)
28/29	1.610 (40.9)	1.560 (39.6)	1.915 (48.6)
32/33	1.610 (40.9)	1.750 (44.5)	1.915 (48.6)
36	1.610 (40.9)	1.750 (44.5)	1.915 (48.6)
40	1.610 (40.9)	2.190 (55.6)	1.915 (48.6)

See inside back cover  
 fold-out or pages 13 and  
 14 for unabridged  
 Tables I and II.

1. When maximum cable entry (page 22) is exceeded, Style 2 will be supplied. (Function S only.)
2. Metric dimensions (mm) are indicated in parentheses.
3. Cable range is defined as the accommodations range for the wire bundle or cable. Dimensions shown are not intended for inspection criteria.
4. Consult factory for shorter lengths on straight backshells.
5. When using Connector Designator B refer to pages 18 and 19 for part number development.

**TABLE IV: ELBOW DIMENSIONS**

Elbow Size	E Max	F Max	G Max	H Max
01	.567 (14.4)	1.848 (46.9)	.636 (16.2)	1.858 (47.2)
02	.567 (14.4)	1.848 (46.9)	.636 (16.2)	1.858 (47.2)
03	.630 (16.0)	1.908 (48.5)	.710 (18.0)	1.978 (50.2)
04	.692 (17.6)	1.968 (50.0)	.731 (18.6)	1.998 (50.7)
10	.755 (19.2)	2.347 (59.6)	.825 (21.0)	2.357 (59.9)
12	.848 (21.5)	2.457 (62.4)	.988 (25.1)	2.447 (62.2)
16	1.036 (26.3)	2.647 (67.2)	1.087 (27.6)	2.617 (66.5)
20	1.130 (28.7)	2.922 (74.2)	1.325 (33.7)	2.852 (72.4)
24	1.255 (31.9)	2.972 (75.5)	1.337 (34.0)	3.022 (76.8)
28	1.317 (33.5)	3.072 (78.0)	1.827 (46.4)	3.272 (83.1)
32	1.348 (34.2)	3.162 (80.3)	2.027 (51.5)	3.272 (83.1)

**TABLE II: STANDARD FINISHES**

GLENAIR	
SYMBOL	FINISH
B	Cadmium Plate, Olive Drab
M	Electroless Nickel
NF	Cadmium Plate, Olive Drab Over Electroless Nickel
See Inside Back Cover for Additional Finish Options	

**TABLE X: CABLE ENTRY**

Dash No.	X Max	Y Max	Z Max	Cable Range	
				Min	Max
01	.850 (21.6)	.781 (19.8)	.593 (15.1)	.062 (1.6)	.125 (3.2)
02	.850 (21.6)	.968 (24.6)	.718 (18.2)	.125 (3.2)	.250 (6.4)
03	.850 (21.6)	1.046 (26.6)	.843 (21.4)	.250 (6.4)	.375 (9.5)
04	.850 (21.6)	1.156 (29.4)	.968 (24.6)	.375 (9.5)	.500 (12.7)
10	.760 (19.3)	1.281 (32.5)	1.192 (30.3)	.375 (9.5)	.625 (15.9)
12	.760 (19.3)	1.500 (38.1)	1.380 (35.1)	.438 (11.1)	.750 (19.1)
16	1.073 (27.3)	1.719 (43.7)	1.535 (39.0)	.562 (14.3)	.938 (23.8)
20	1.323 (33.6)	2.062 (52.4)	1.848 (46.9)	.750 (19.1)	1.250 (31.8)
24	1.323 (33.6)	2.312 (58.7)	2.255 (57.3)	.875 (22.2)	1.375 (34.9)
28	1.572 (39.9)	2.719 (69.1)	2.505 (63.6)	1.125 (28.6)	1.625 (41.3)