

380-014
EMI/RFI Non-Environmental Backshell
with Strain Relief
Type D - Direct Coupling - Low Profile

CONNECTOR DESIGNATORS
A-B*-C-D-E-F
G-H-J-K-L-S

** Conn. Desig. B See Note 5*
DIRECT COUPLING

TYPE D INDIVIDUAL OR OVERALL SHIELD TERMINATION

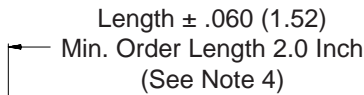
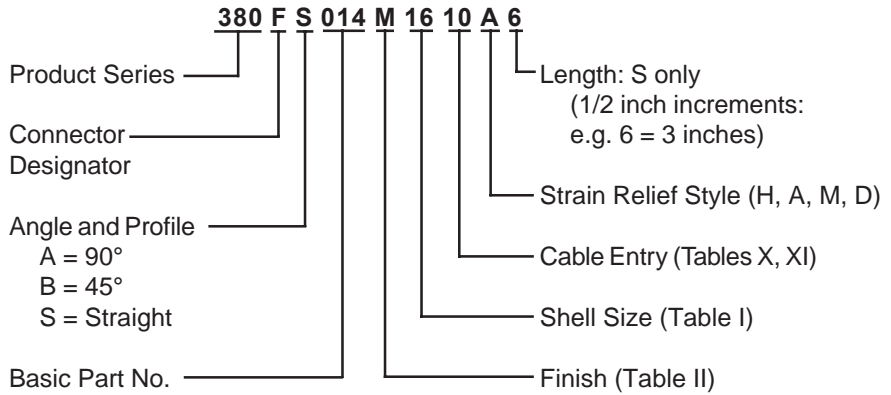

STYLE 2 (STRAIGHT)
 See Note 1)

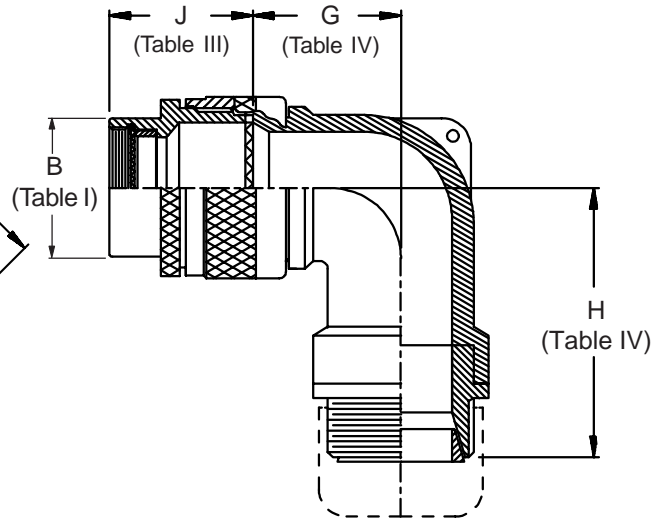
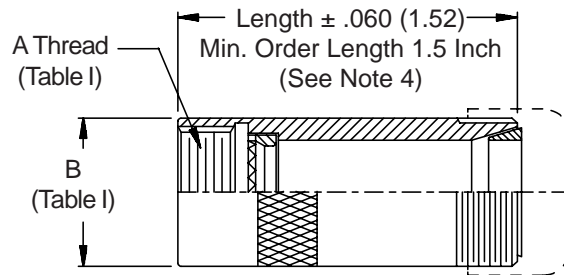
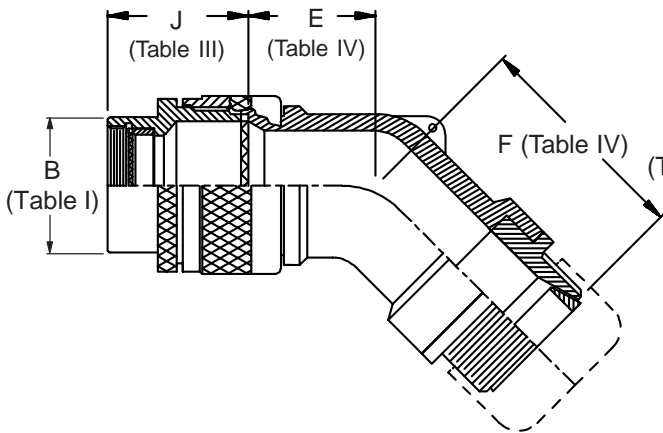

STYLE H
 Heavy Duty (Table X)

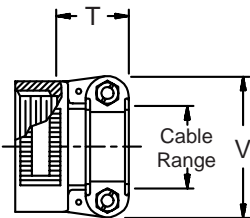

STYLE A
 Medium Duty (Table XI)

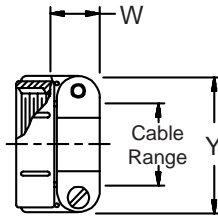

STYLE M
 Medium Duty (Table XI)

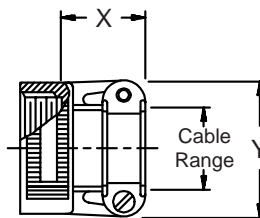

STYLE D
 Medium Duty (Table XI)

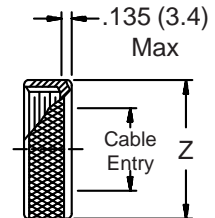

380-014
EMI/RFI Non-Environmental Backshell
with Strain Relief
Type D - Direct Coupling - Low Profile



See inside back cover fold-out or pages 13 and 14 for unabridged Tables I and II.

TABLE III: FRONT ADAPTER

Shell Size	J Max - Conn. Designator		
	A-E-F		
	J-H-L-S	D-B-G-K	C
08/09	1.180 (30.0)	1.440 (36.6)	
10/11	1.180 (30.0)	1.440 (36.6)	
12/13	1.180 (30.0)	1.440 (36.6)	1.735 (44.1)
14/15	1.180 (30.0)	1.440 (36.6)	1.915 (48.6)
16/17	1.380 (35.0)	1.560 (39.6)	1.915 (48.6)
18/19	1.380 (35.0)	1.560 (39.6)	1.915 (48.6)
20/21	1.380 (35.0)	1.560 (39.6)	1.915 (48.6)
22/23	1.380 (35.0)	1.560 (39.6)	1.915 (48.6)
24/25	1.380 (35.0)	1.560 (39.6)	1.915 (48.6)
28/29	1.610 (40.9)	1.560 (39.6)	1.915 (48.6)
32/33	1.610 (40.9)	1.750 (44.5)	1.915 (48.6)
36	1.610 (40.9)	1.750 (44.5)	1.915 (48.6)
40	1.610 (40.9)	2.190 (55.6)	1.915 (48.6)

TABLE IV: ELBOW DIMENSIONS

Elbow Size	E Max	F Max	G Max	H Max
03	.630 (16.0)	1.730 (43.9)	.636 (16.2)	1.680 (42.7)
04	.630 (16.0)	1.730 (43.9)	.636 (16.2)	1.680 (42.7)
06	.630 (16.0)	1.730 (43.9)	.710 (18.0)	1.800 (45.7)
08	.692 (17.6)	1.790 (45.5)	.731 (18.6)	1.820 (46.2)
10	.755 (19.2)	1.880 (47.8)	.825 (21.0)	1.890 (48.0)
12	.848 (21.5)	1.990 (50.5)	.988 (25.1)	1.980 (50.3)
16	1.036 (26.3)	2.180 (55.4)	1.087 (27.6)	2.150 (54.6)
20	1.130 (28.7)	2.330 (59.2)	1.325 (33.7)	2.260 (57.4)
24	1.255 (31.9)	2.380 (60.5)	1.337 (34.0)	2.430 (61.7)
28	1.317 (33.5)	2.480 (63.0)	1.827 (46.4)	2.680 (68.1)
32	1.348 (34.2)	2.570 (65.3)	2.027 (51.5)	2.680 (68.1)

TABLE II: STANDARD FINISHES

GLENAIR SYMBOL	FINISH
B	Cadmium Plate, Olive Drab
M	Electroless Nickel
NF	Cadmium Plate, Olive Drab Over Electroless Nickel

See Inside Back Cover for Additional Finish Options

TABLE X: CABLE ENTRY

Dash No.	T Max	V Max	Cable Range	
			Min	Max
04	.780 (19.8)	.957 (24.3)	.125 (3.2)	.312 (7.9)
06	.780 (19.8)	1.145 (29.1)	.250 (6.4)	.437 (11.1)
08	.780 (19.8)	1.332 (33.8)	.312 (7.9)	.562 (14.3)
10	.780 (19.8)	1.332 (33.8)	.350 (8.9)	.625 (15.9)
12	.811 (20.6)	1.551 (39.4)	.500 (12.7)	.750 (19.1)
16	.905 (23.0)	1.770 (45.0)	.625 (15.9)	.937 (23.8)
20	1.092 (27.7)	2.113 (53.7)	.875 (22.2)	1.250 (31.8)
24	1.124 (28.5)	2.363 (60.0)	1.000 (25.4)	1.375 (34.9)
28	1.399 (35.5)	2.770 (70.4)	1.250 (31.8)	1.625 (41.3)
32	1.399 (35.5)	3.020 (76.7)	1.437 (36.5)	1.875 (47.6)

- When maximum cable entry (page 22) is exceeded, Style 2 will be supplied. (Function S only).
- Metric dimensions (mm) are indicated in parentheses.
- Cable range is defined as the accommodations range for the wire bundle or cable. Dimensions shown are not intended for inspection criteria.

TABLE XI: CABLE ENTRY

Dash No.	W Max	X Max	Y Max	Z Max	Cable Range	
					Min**	Max
03*	.437 (11.1)	.760 (19.3)	.843 (21.4)	.630 (16.0)	.156 (4.0)	.250 (6.4)
04*	.437 (11.1)	.760 (19.3)	.906 (23.0)	.755 (19.2)	.188 (4.8)	.312 (7.9)
06*	.500 (12.7)	.760 (19.3)	1.093 (27.8)	.942 (23.9)	.281 (7.1)	.438 (11.1)
08	.563 (14.3)	.760 (19.3)	1.187 (30.1)	1.067 (27.1)	.344 (8.7)	.562 (14.3)
10	.563 (14.3)	.760 (19.3)	1.281 (32.5)	1.192 (30.3)	.375 (9.5)	.625 (15.9)
12	.563 (14.3)	.760 (19.3)	1.500 (38.1)	1.380 (35.1)	.438 (11.1)	.750 (19.1)
16	.656 (16.7)	1.073 (27.3)	1.719 (43.7)	1.535 (39.0)	.562 (14.3)	.938 (23.8)
20	.656 (16.7)	1.323 (33.6)	2.062 (52.4)	1.848 (46.9)	.750 (19.1)	1.250 (31.8)
24	.656 (16.7)	1.323 (33.6)	2.312 (58.7)	2.255 (57.3)	.781 (19.8)	1.375 (34.9)
28	1.188 (30.2)	1.572 (39.9)	2.719 (69.1)	2.505 (63.6)	.969 (24.6)	1.625 (41.3)
32*	1.187 (30.1)	1.572 (39.9)	2.969 (75.4)	2.755 (70.0)	1.125 (28.6)	1.875 (47.6)
40*	1.125 (28.6)	1.572 (39.9)	3.531 (89.7)	3.255 (82.7)	1.469 (37.3)	2.375 (60.3)

* Not available in Style M clamp. ** Not Applicable Style D

- Consult factory for shorter lengths on straight backshells.
- When using Connector Designator B refer to pages 18 and 19 for part number development.