

**380-019**  
**EMI/RFI Non-Environmental Backshell**  
**with Strain Relief**  
**Type E - Direct Coupling - Low Profile**

**CONNECTOR DESIGNATORS**  
**A-B\*-C-D-E-F**  
**G-H-J-K-L-S**  
 \* Conn. Desig. B See Note 5  
**DIRECT COUPLING**

**TYPE E INDIVIDUAL AND/OR OVERALL SHIELD TERMINATION**

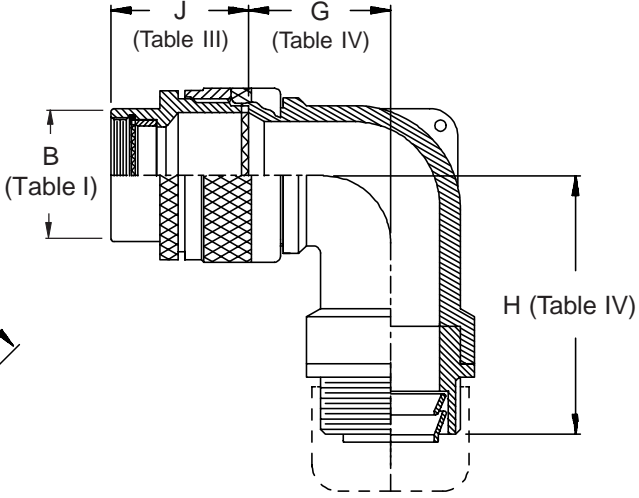
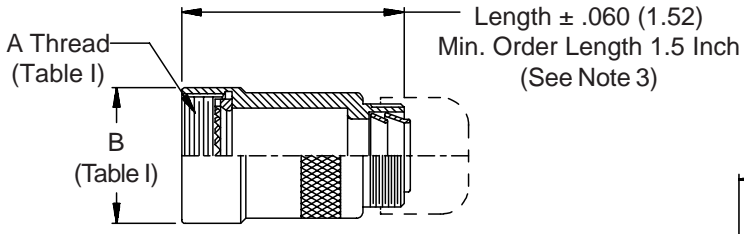
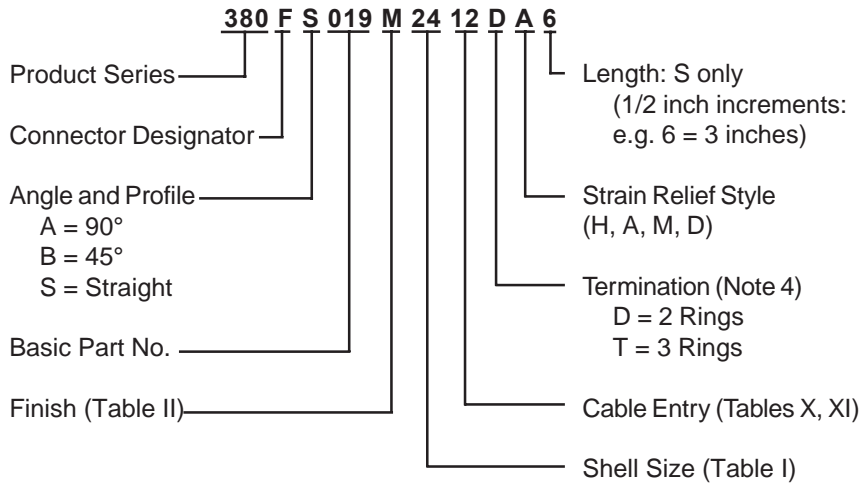

**STYLE H**  
 Heavy Duty  
 (Table X)

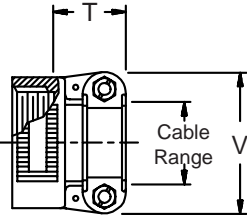

**STYLE A**  
 Medium Duty  
 (Table XI)

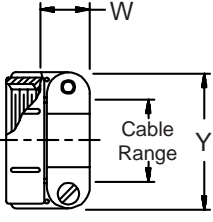

**STYLE M**  
 Medium Duty  
 (Table XI)

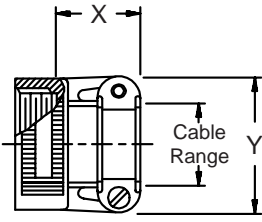

**STYLE D**  
 Medium Duty  
 (Table XI)

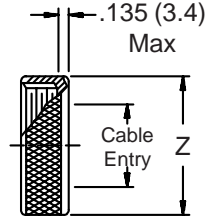

**380-019**  
**EMI/RFI Non-Environmental Backshell**  
with Strain Relief  
Type E - Direct Coupling - Low Profile



See inside back cover fold-out or pages 13 and 14 for unabridged Tables I and II.

| TABLE III: FRONT ADAPTER |                          |              |              |
|--------------------------|--------------------------|--------------|--------------|
| Shell Size               | J Max - Conn. Designator |              |              |
|                          | A-E-F                    |              | C            |
|                          | J-H-L-S                  | D-B-G-K      |              |
| 08/09                    | 1.180 (30.0)             | 1.440 (36.6) |              |
| 10/11                    | 1.180 (30.0)             | 1.440 (36.6) |              |
| 12/13                    | 1.180 (30.0)             | 1.440 (36.6) | 1.735 (44.1) |
| 14/15                    | 1.180 (30.0)             | 1.440 (36.6) | 1.915 (48.6) |
| 16/17                    | 1.380 (35.0)             | 1.560 (39.6) | 1.915 (48.6) |
| 18/19                    | 1.380 (35.0)             | 1.560 (39.6) | 1.915 (48.6) |
| 20/21                    | 1.380 (35.0)             | 1.560 (39.6) | 1.915 (48.6) |
| 22/23                    | 1.380 (35.0)             | 1.560 (39.6) | 1.915 (48.6) |
| 24/25                    | 1.380 (35.0)             | 1.560 (39.6) | 1.915 (48.6) |
| 28/29                    | 1.610 (40.9)             | 1.560 (39.6) | 1.915 (48.6) |
| 32/33                    | 1.610 (40.9)             | 1.750 (44.5) | 1.915 (48.6) |
| 36                       | 1.610 (40.9)             | 1.750 (44.5) | 1.915 (48.6) |
| 40                       | 1.610 (40.9)             | 2.190 (55.6) | 1.915 (48.6) |

| TABLE IV: ELBOW DIMENSIONS |              |              |              |              |  |
|----------------------------|--------------|--------------|--------------|--------------|--|
| Elbow Size                 | E Max        | F Max        | G Max        | H Max        |  |
| 03                         | .457 (11.6)  | 1.470 (37.3) | .500 (12.7)  | 1.480 (37.6) |  |
| 04                         | .457 (11.6)  | 1.470 (37.3) | .500 (12.7)  | 1.480 (37.6) |  |
| 06                         | .520 (13.2)  | 1.530 (38.9) | .595 (15.1)  | 1.600 (40.6) |  |
| 08                         | .582 (14.8)  | 1.590 (40.4) | .610 (15.5)  | 1.620 (41.1) |  |
| 10                         | .645 (16.4)  | 1.680 (42.7) | .700 (17.8)  | 1.690 (42.9) |  |
| 12                         | .738 (18.7)  | 1.790 (45.5) | .885 (22.5)  | 1.950 (49.5) |  |
| 16                         | .926 (23.5)  | 1.980 (50.3) | .975 (24.8)  | 2.060 (52.3) |  |
| 20                         | 1.020 (25.9) | 2.130 (54.1) | 1.125 (28.6) | 2.060 (52.3) |  |

- Metric dimensions (mm) are indicated in parentheses.
- Cable range is defined as the accommodations range for the wire bundle or cable. Dimensions shown are not for inspection criteria.
- Consult factory for shorter lengths on straight backshells.
- Designate Symbol T for 3 ring termination of individual and overall braid. Designate D for standard 2 ring termination of individual or overall braid.
- When using Connector Designator B refer to pages 18 and 19 for part number development.

| TABLE X: CABLE ENTRY |              |              |              |              |  |
|----------------------|--------------|--------------|--------------|--------------|--|
| Dash No.             | T Max        | V Max        | Cable Range  |              |  |
|                      |              |              | Min          | Max          |  |
| 04                   | .780 (19.8)  | .957 (24.3)  | .125 (3.2)   | .312 (7.9)   |  |
| 06                   | .780 (19.8)  | 1.145 (29.1) | .250 (6.4)   | .437 (11.1)  |  |
| 08                   | .780 (19.8)  | 1.332 (33.8) | .312 (7.9)   | .562 (14.3)  |  |
| 10                   | .780 (19.8)  | 1.332 (33.8) | .350 (8.9)   | .625 (15.9)  |  |
| 12                   | .811 (20.6)  | 1.551 (39.4) | .500 (12.7)  | .750 (19.1)  |  |
| 16                   | .905 (23.0)  | 1.770 (45.0) | .625 (15.9)  | .937 (23.8)  |  |
| 20                   | 1.092 (27.7) | 2.113 (53.7) | .875 (22.2)  | 1.250 (31.8) |  |
| 24                   | 1.124 (28.5) | 2.363 (60.0) | 1.000 (25.4) | 1.375 (34.9) |  |
| 28                   | 1.399 (35.5) | 2.770 (70.4) | 1.250 (31.8) | 1.625 (41.3) |  |
| 32                   | 1.399 (35.5) | 3.020 (76.7) | 1.437 (36.5) | 1.875 (47.6) |  |

| TABLE II: STANDARD FINISHES |   |
|-----------------------------|---|
| GLENAIR SYMBOL              | FINISH  |
| B                           | Cadmium Plate, Olive Drab                         |
| M                           | Electroless Nickel                                |
| NF                          | Cadmium Plate, Olive Drab Over Electroless Nickel |

See Inside Back Cover for Additional Finish Options

| TABLE XI: CABLE ENTRY |              |              |              |              |              |              |  |
|-----------------------|--------------|--------------|--------------|--------------|--------------|--------------|--|
| Dash No.              | W Max        | X Max        | Y Max        | Z Max        | Cable Range  |              |  |
|                       |              |              |              |              | Min **       | Max          |  |
| 03*                   | .437 (11.1)  | .760 (19.3)  | .843 (21.4)  | .630 (16.0)  | .156 (4.0)   | .250 (6.4)   |  |
| 04*                   | .437 (11.1)  | .760 (19.3)  | .906 (23.0)  | .755 (19.2)  | .188 (4.8)   | .312 (7.9)   |  |
| 06*                   | .500 (12.7)  | .760 (19.3)  | 1.093 (27.8) | .942 (23.9)  | .281 (7.1)   | .438 (11.1)  |  |
| 08                    | .563 (14.3)  | .760 (19.3)  | 1.187 (30.1) | 1.067 (27.1) | .344 (8.7)   | .562 (14.3)  |  |
| 10                    | .563 (14.3)  | .760 (19.3)  | 1.281 (32.5) | 1.192 (30.3) | .375 (9.5)   | .625 (15.9)  |  |
| 12                    | .563 (14.3)  | .760 (19.3)  | 1.500 (38.1) | 1.380 (35.1) | .438 (11.1)  | .750 (19.1)  |  |
| 16                    | .656 (16.7)  | 1.073 (27.3) | 1.719 (43.7) | 1.535 (39.0) | .562 (14.3)  | .938 (23.8)  |  |
| 20                    | .656 (16.7)  | 1.323 (33.6) | 2.062 (52.4) | 1.848 (46.9) | .750 (19.1)  | 1.250 (31.8) |  |
| 24                    | .656 (16.7)  | 1.323 (33.6) | 2.312 (58.7) | 2.255 (57.3) | .781 (19.8)  | 1.375 (34.9) |  |
| 28                    | 1.188 (30.2) | 1.572 (39.9) | 2.719 (69.1) | 2.505 (63.6) | .969 (24.6)  | 1.625 (41.3) |  |
| 32*                   | 1.187 (30.1) | 1.572 (39.9) | 2.969 (75.4) | 2.755 (70.0) | 1.125 (28.6) | 1.875 (47.6) |  |
| 40*                   | 1.125 (28.6) | 1.572 (39.9) | 3.531 (89.7) | 3.255 (82.7) | 1.469 (37.3) | 2.375 (60.3) |  |

\* Not available in Style M clamp.      \*\* Not Applicable Style D