

**380-019**  
**EMI/RFI Non-Environmental Backshell**  
**with Strain Relief**  
**Type E - Direct Coupling - Low Profile**

**CONNECTOR DESIGNATORS**  
**A-B\*-C-D-E-F**  
**G-H-J-K-L-S**  
 \* Conn. Desig. B See Note 5  
**DIRECT COUPLING**

**TYPE E INDIVIDUAL AND/OR OVERALL SHIELD TERMINATION**

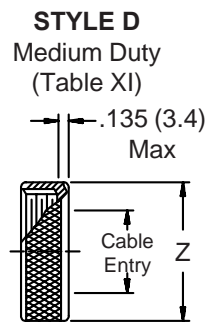
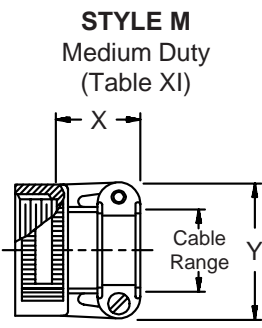
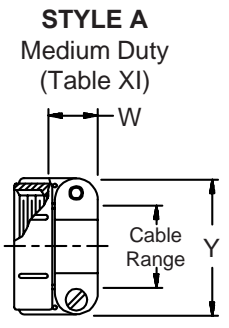
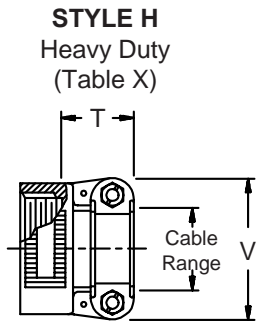
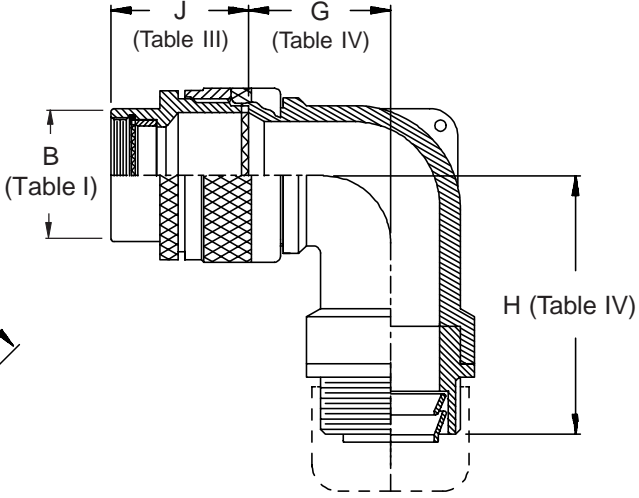
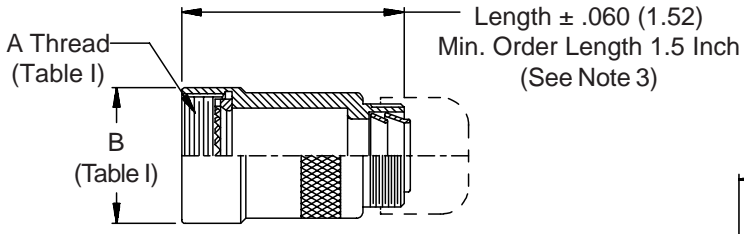
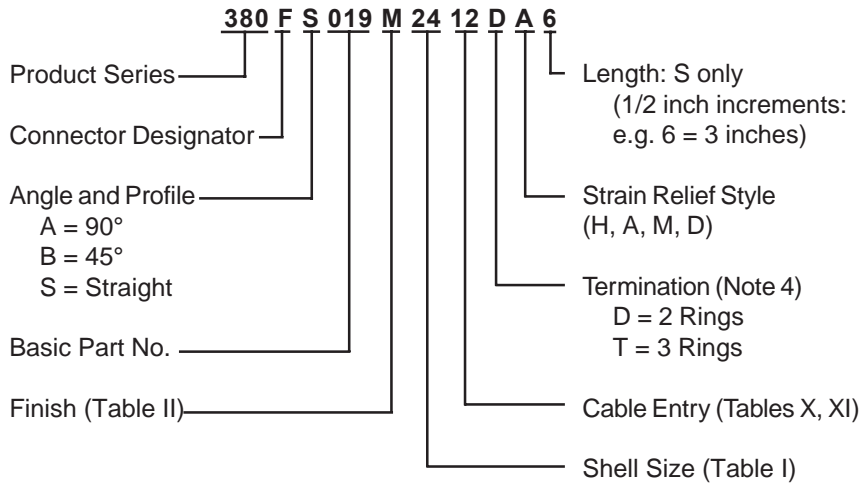

**380-019**  
**EMI/RFI Non-Environmental Backshell**  
with Strain Relief  
Type E - Direct Coupling - Low Profile



See inside back cover fold-out or pages 13 and 14 for unabridged Tables I and II.

TABLE III: FRONT ADAPTER			
Shell Size	J Max - Conn. Designator		
	A-E-F		C
	J-H-L-S	D-B-G-K	
08/09	1.180 (30.0)	1.440 (36.6)	
10/11	1.180 (30.0)	1.440 (36.6)	
12/13	1.180 (30.0)	1.440 (36.6)	1.735 (44.1)
14/15	1.180 (30.0)	1.440 (36.6)	1.915 (48.6)
16/17	1.380 (35.0)	1.560 (39.6)	1.915 (48.6)
18/19	1.380 (35.0)	1.560 (39.6)	1.915 (48.6)
20/21	1.380 (35.0)	1.560 (39.6)	1.915 (48.6)
22/23	1.380 (35.0)	1.560 (39.6)	1.915 (48.6)
24/25	1.380 (35.0)	1.560 (39.6)	1.915 (48.6)
28/29	1.610 (40.9)	1.560 (39.6)	1.915 (48.6)
32/33	1.610 (40.9)	1.750 (44.5)	1.915 (48.6)
36	1.610 (40.9)	1.750 (44.5)	1.915 (48.6)
40	1.610 (40.9)	2.190 (55.6)	1.915 (48.6)

TABLE IV: ELBOW DIMENSIONS					
Elbow Size	E Max	F Max	G Max	H Max	
03	.457 (11.6)	1.470 (37.3)	.500 (12.7)	1.480 (37.6)	
04	.457 (11.6)	1.470 (37.3)	.500 (12.7)	1.480 (37.6)	
06	.520 (13.2)	1.530 (38.9)	.595 (15.1)	1.600 (40.6)	
08	.582 (14.8)	1.590 (40.4)	.610 (15.5)	1.620 (41.1)	
10	.645 (16.4)	1.680 (42.7)	.700 (17.8)	1.690 (42.9)	
12	.738 (18.7)	1.790 (45.5)	.885 (22.5)	1.950 (49.5)	
16	.926 (23.5)	1.980 (50.3)	.975 (24.8)	2.060 (52.3)	
20	1.020 (25.9)	2.130 (54.1)	1.125 (28.6)	2.060 (52.3)	

1. Metric dimensions (mm) are indicated in parentheses.
2. Cable range is defined as the accommodations range for the wire bundle or cable. Dimensions shown are not for inspection criteria.
3. Consult factory for shorter lengths on straight backshells.
4. Designate Symbol T for 3 ring termination of individual and overall

TABLE X: CABLE ENTRY					
Dash No.	T Max	V Max	Cable Range		
			Min	Max	
04	.780 (19.8)	.957 (24.3)	.125 (3.2)	.312 (7.9)	
06	.780 (19.8)	1.145 (29.1)	.250 (6.4)	.437 (11.1)	
08	.780 (19.8)	1.332 (33.8)	.312 (7.9)	.562 (14.3)	
10	.780 (19.8)	1.332 (33.8)	.350 (8.9)	.625 (15.9)	
12	.811 (20.6)	1.551 (39.4)	.500 (12.7)	.750 (19.1)	
16	.905 (23.0)	1.770 (45.0)	.625 (15.9)	.937 (23.8)	
20	1.092 (27.7)	2.113 (53.7)	.875 (22.2)	1.250 (31.8)	
24	1.124 (28.5)	2.363 (60.0)	1.000 (25.4)	1.375 (34.9)	
28	1.399 (35.5)	2.770 (70.4)	1.250 (31.8)	1.625 (41.3)	
32	1.399 (35.5)	3.020 (76.7)	1.437 (36.5)	1.875 (47.6)	

TABLE II: STANDARD FINISHES	
GLENAIR SYMBOL	FINISH
B	Cadmium Plate, Olive Drab
M	Electroless Nickel
NF	Cadmium Plate, Olive Drab Over Electroless Nickel

See Inside Back Cover for Additional Finish Options

5. When using Connector Designator B refer to pages 18 and 19 for part number development.

TABLE XI: CABLE ENTRY							
Dash No.	W Max	X Max	Y Max	Z Max	Cable Range		
					Min **	Max	
03*	.437 (11.1)	.760 (19.3)	.843 (21.4)	.630 (16.0)	.156 (4.0)	.250 (6.4)	
04*	.437 (11.1)	.760 (19.3)	.906 (23.0)	.755 (19.2)	.188 (4.8)	.312 (7.9)	
06*	.500 (12.7)	.760 (19.3)	1.093 (27.8)	.942 (23.9)	.281 (7.1)	.438 (11.1)	
08	.563 (14.3)	.760 (19.3)	1.187 (30.1)	1.067 (27.1)	.344 (8.7)	.562 (14.3)	
10	.563 (14.3)	.760 (19.3)	1.281 (32.5)	1.192 (30.3)	.375 (9.5)	.625 (15.9)	
12	.563 (14.3)	.760 (19.3)	1.500 (38.1)	1.380 (35.1)	.438 (11.1)	.750 (19.1)	
16	.656 (16.7)	1.073 (27.3)	1.719 (43.7)	1.535 (39.0)	.562 (14.3)	.938 (23.8)	
20	.656 (16.7)	1.323 (33.6)	2.062 (52.4)	1.848 (46.9)	.750 (19.1)	1.250 (31.8)	
24	.656 (16.7)	1.323 (33.6)	2.312 (58.7)	2.255 (57.3)	.781 (19.8)	1.375 (34.9)	
28	1.188 (30.2)	1.572 (39.9)	2.719 (69.1)	2.505 (63.6)	.969 (24.6)	1.625 (41.3)	
32*	1.187 (30.1)	1.572 (39.9)	2.969 (75.4)	2.755 (70.0)	1.125 (28.6)	1.875 (47.6)	
40*	1.125 (28.6)	1.572 (39.9)	3.531 (89.7)	3.255 (82.7)	1.469 (37.3)	2.375 (60.3)	

\* Not available in Style M clamp.      \*\* Not Applicable Style D