

**380-019**  
**EMI/RFI Non-Environmental Backshell**  
**with Strain Relief**  
**Type E - Direct Coupling - Low Profile**

**CONNECTOR DESIGNATORS**  
**A-B\*-C-D-E-F**  
**G-H-J-K-L-S**  
 \* Conn. Desig. B See Note 5  
**DIRECT COUPLING**

**TYPE E INDIVIDUAL AND/OR OVERALL SHIELD TERMINATION**

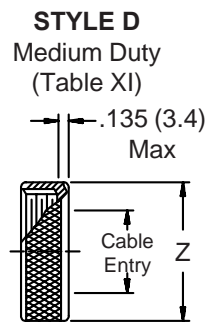

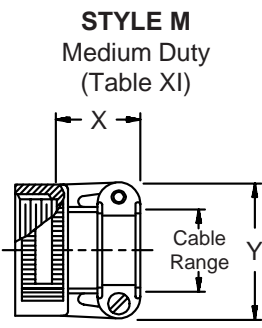
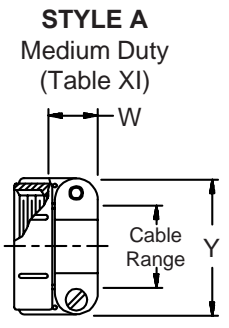
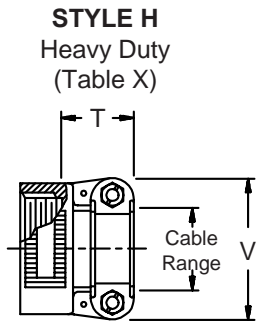
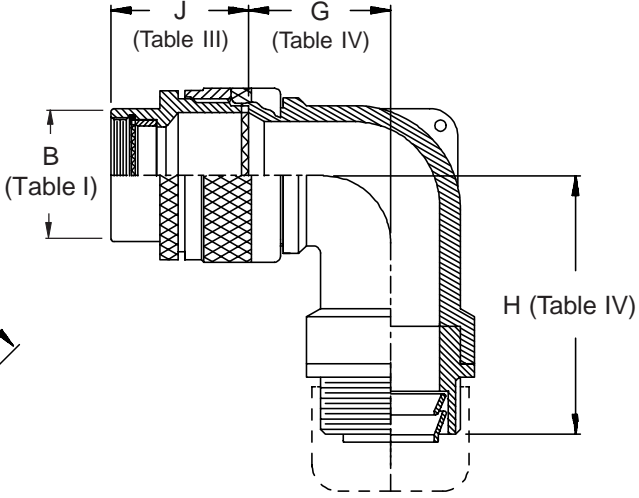
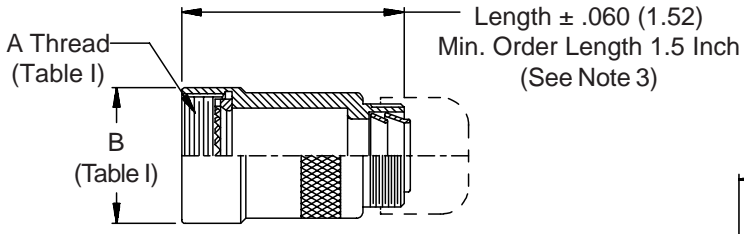
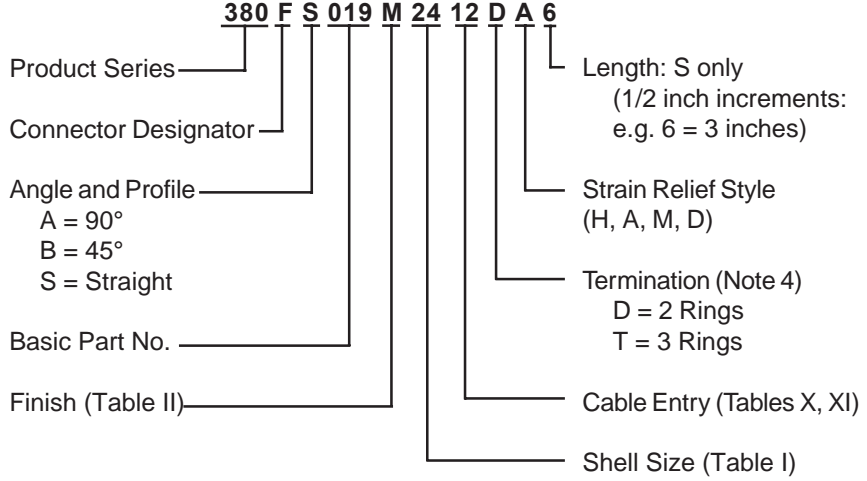

See inside back cover fold-out or pages 13 and 14 for unabridged Tables I and II.

**TABLE III: FRONT ADAPTER**

Shell Size	J Max - Conn. Designator		
	A-E-F		
	J-H-L-S	D-B-G-K	C
08/09	1.180 (30.0)	1.440 (36.6)	
10/11	1.180 (30.0)	1.440 (36.6)	
12/13	1.180 (30.0)	1.440 (36.6)	1.735 (44.1)
14/15	1.180 (30.0)	1.440 (36.6)	1.915 (48.6)
16/17	1.380 (35.0)	1.560 (39.6)	1.915 (48.6)
18/19	1.380 (35.0)	1.560 (39.6)	1.915 (48.6)
20/21	1.380 (35.0)	1.560 (39.6)	1.915 (48.6)
22/23	1.380 (35.0)	1.560 (39.6)	1.915 (48.6)
24/25	1.380 (35.0)	1.560 (39.6)	1.915 (48.6)
28/29	1.610 (40.9)	1.560 (39.6)	1.915 (48.6)
32/33	1.610 (40.9)	1.750 (44.5)	1.915 (48.6)
36	1.610 (40.9)	1.750 (44.5)	1.915 (48.6)
40	1.610 (40.9)	2.190 (55.6)	1.915 (48.6)

**TABLE IV: ELBOW DIMENSIONS**

Elbow Size	E Max	F Max	G Max	H Max
03	.457 (11.6)	1.470 (37.3)	.500 (12.7)	1.480 (37.6)
04	.457 (11.6)	1.470 (37.3)	.500 (12.7)	1.480 (37.6)
06	.520 (13.2)	1.530 (38.9)	.595 (15.1)	1.600 (40.6)
08	.582 (14.8)	1.590 (40.4)	.610 (15.5)	1.620 (41.1)
10	.645 (16.4)	1.680 (42.7)	.700 (17.8)	1.690 (42.9)
12	.738 (18.7)	1.790 (45.5)	.885 (22.5)	1.950 (49.5)
16	.926 (23.5)	1.980 (50.3)	.975 (24.8)	2.060 (52.3)
20	1.020 (25.9)	2.130 (54.1)	1.125 (28.6)	2.060 (52.3)

1. Metric dimensions (mm) are indicated in parentheses.
2. Cable range is defined as the accommodations range for the wire bundle or cable. Dimensions shown are not for inspection criteria.
3. Consult factory for shorter lengths on straight backshells.
4. Designate Symbol T for 3 ring termination of individual and overall

**TABLE X: CABLE ENTRY**

Dash No.	T Max	V Max	Cable Range	
			Min	Max
			04	.780 (19.8)
06	.780 (19.8)	1.145 (29.1)	.250 (6.4)	.437 (11.1)
08	.780 (19.8)	1.332 (33.8)	.312 (7.9)	.562 (14.3)
10	.780 (19.8)	1.332 (33.8)	.350 (8.9)	.625 (15.9)
12	.811 (20.6)	1.551 (39.4)	.500 (12.7)	.750 (19.1)
16	.905 (23.0)	1.770 (45.0)	.625 (15.9)	.937 (23.8)
20	1.092 (27.7)	2.113 (53.7)	.875 (22.2)	1.250 (31.8)
24	1.124 (28.5)	2.363 (60.0)	1.000 (25.4)	1.375 (34.9)
28	1.399 (35.5)	2.770 (70.4)	1.250 (31.8)	1.625 (41.3)
32	1.399 (35.5)	3.020 (76.7)	1.437 (36.5)	1.875 (47.6)

5. When using Connector Designator B refer to pages 18 and 19 for part number development.

**TABLE II: STANDARD FINISHES**

GLENAIR SYMBOL	FINISH
B	Cadmium Plate, Olive Drab
M	Electroless Nickel
NF	Cadmium Plate, Olive Drab Over Electroless Nickel

See Inside Back Cover for Additional Finish Options

**TABLE XI: CABLE ENTRY**

Dash No.	W Max	X Max	Y Max	Z Max	Cable Range	
					Min **	Max
					03*	.437 (11.1)
04*	.437 (11.1)	.760 (19.3)	.906 (23.0)	.755 (19.2)	.188 (4.8)	.312 (7.9)
06*	.500 (12.7)	.760 (19.3)	1.093 (27.8)	.942 (23.9)	.281 (7.1)	.438 (11.1)
08	.563 (14.3)	.760 (19.3)	1.187 (30.1)	1.067 (27.1)	.344 (8.7)	.562 (14.3)
10	.563 (14.3)	.760 (19.3)	1.281 (32.5)	1.192 (30.3)	.375 (9.5)	.625 (15.9)
12	.563 (14.3)	.760 (19.3)	1.500 (38.1)	1.380 (35.1)	.438 (11.1)	.750 (19.1)
16	.656 (16.7)	1.073 (27.3)	1.719 (43.7)	1.535 (39.0)	.562 (14.3)	.938 (23.8)
20	.656 (16.7)	1.323 (33.6)	2.062 (52.4)	1.848 (46.9)	.750 (19.1)	1.250 (31.8)
24	.656 (16.7)	1.323 (33.6)	2.312 (58.7)	2.255 (57.3)	.781 (19.8)	1.375 (34.9)
28	1.188 (30.2)	1.572 (39.9)	2.719 (69.1)	2.505 (63.6)	.969 (24.6)	1.625 (41.3)
32*	1.187 (30.1)	1.572 (39.9)	2.969 (75.4)	2.755 (70.0)	1.125 (28.6)	1.875 (47.6)
40*	1.125 (28.6)	1.572 (39.9)	3.531 (89.7)	3.255 (82.7)	1.469 (37.3)	2.375 (60.3)

\* Not available in Style M clamp.      \*\* Not Applicable Style D