

380-018
EMI/RFI Non-Environmental Backshell
with Strain Relief
Type E - Rotatable Coupling - Low Profile

**CONNECTOR
 DESIGNATORS
 A-F-H-L-S**

**ROTATABLE
 COUPLING**

**TYPE E INDIVIDUAL
 AND/OR OVERALL
 SHIELD TERMINATION**

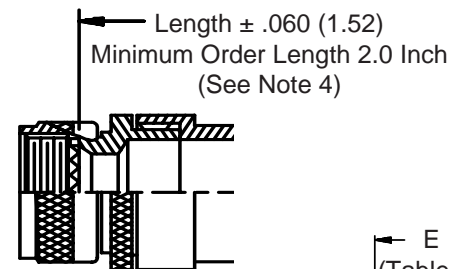
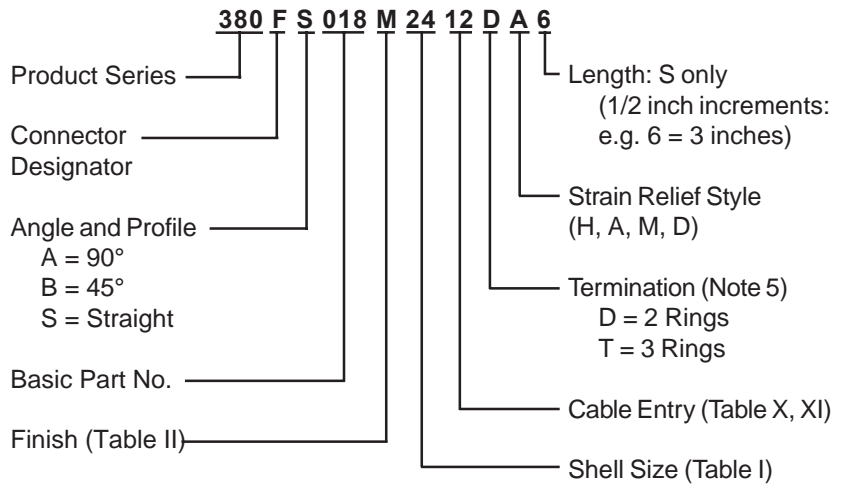

STYLE 2 (STRAIGHT)
 See Note 1)

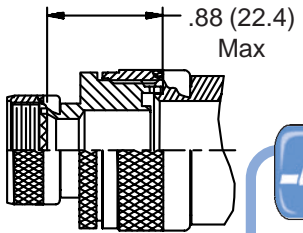
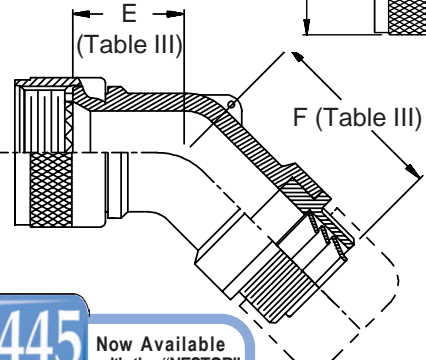
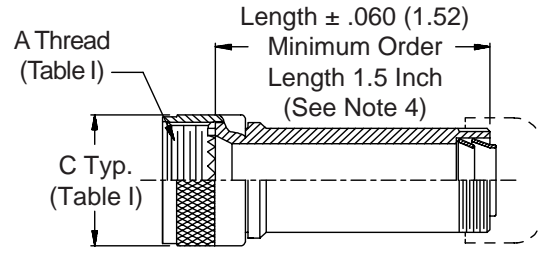

STYLE 2 (45° & 90°)
 See Note 1)

-445 Now Available with the "NESTOR"
 Glenair's Non-Detent, Spring-Loaded, Self-Locking Coupling. Add "-445" to Specify This AS85049 Style "N" Coupling Interface.

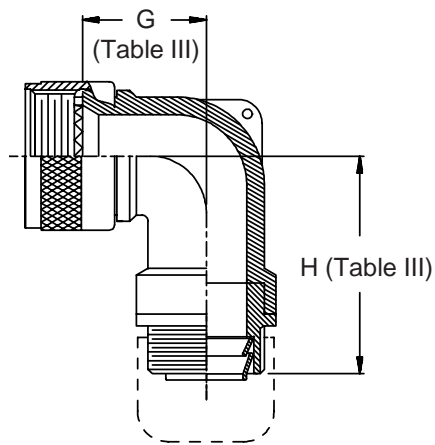

STYLE H Heavy Duty
 (Table X)

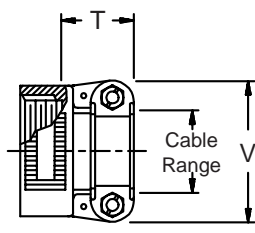

STYLE A Medium Duty
 (Table XI)

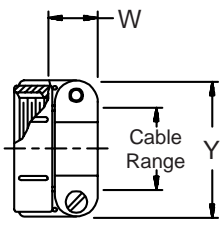

STYLE M Medium Duty
 (Table XI)

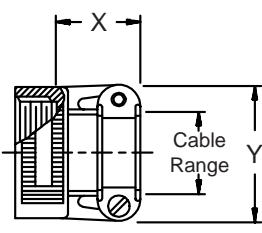

STYLE D Medium Duty
 (Table XI)

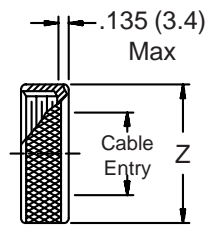

380-018
EMI/RFI Non-Environmental Backshell
with Strain Relief
Type E - Rotatable Coupling - Low Profile



See inside back cover fold-out or pages 13 and 14 for unabridged Tables I and II.

TABLE III: ELBOW DIMENSIONS

Shell Size		E Max	F Max	G Max	H Max
Conn. Desig. A-F-L-S	H				
08	09	.520 (13.2)	1.680 (47.2)	.477 (12.7)	1.730 (43.9)
10	11	.615 (15.6)	1.800 (45.7)	.540 (13.7)	1.730 (43.9)
12	13	.630 (16.0)	1.820 (46.2)	.602 (15.3)	1.790 (45.5)
14	15	.720 (18.3)	1.890 (48.0)	.665 (19.6)	1.880 (47.8)
16	17	.905 (23.0)	1.980 (50.3)	.758 (19.2)	1.990 (50.5)
18	19	.995 (25.3)	2.150 (54.6)	.946 (24.0)	2.180 (55.4)
20	21	.995 (25.3)	2.150 (54.6)	.946 (24.0)	2.180 (55.4)
22	23	1.145 (29.1)	2.260 (57.4)	1.040 (26.4)	2.330 (59.2)
24	25	1.145 (29.1)	2.260 (57.4)	1.040 (26.4)	2.330 (59.2)

TABLE II: STANDARD FINISHES

GLENAIR SYMBOL	FINISH
B	Cadmium Plate, Olive Drab
M	Electroless Nickel
NF	Cadmium Plate, Olive Drab Over Electroless Nickel
See Inside Back Cover for Additional Finish Options	

TABLE X: CABLE ENTRY

Dash No.	T Max	V Max	Cable Range	
			Min	Max
04	.780 (19.8)	.957 (24.3)	.125 (3.2)	.312 (7.9)
06	.780 (19.8)	1.145 (29.1)	.250 (6.4)	.437 (11.1)
08	.780 (19.8)	1.332 (33.8)	.312 (7.9)	.562 (14.3)
10	.780 (19.8)	1.332 (33.8)	.350 (8.9)	.625 (15.9)
12	.811 (20.6)	1.551 (39.4)	.500 (12.7)	.750 (19.1)
16	.905 (23.0)	1.770 (45.0)	.625 (15.9)	.937 (23.8)
20	1.092 (27.7)	2.113 (53.7)	.875 (22.2)	1.250 (31.8)
24	1.124 (28.5)	2.363 (60.0)	1.000 (25.4)	1.375 (34.9)
28	1.399 (35.5)	2.770 (70.4)	1.250 (31.8)	1.625 (41.3)
32	1.399 (35.5)	3.020 (76.7)	1.437 (36.5)	1.875 (47.6)

1. When maximum cable entry (page 21) is exceeded, Style 2 will be supplied. Dimensions E, F, G and H will not apply. Please consult factory.
2. Metric dimensions (mm) are indicated in parentheses.
3. Cable range is defined as the accommodations range for the wire bundle or cable. Dimensions shown are not intended for inspection criteria.
4. Consult factory for shorter lengths on straight backshells.
5. Designate Symbol T for 3 ring termination of individual and overall braid. Designate D for standard 2 ring termination of individual or overall braid.

TABLE XI: CABLE ENTRY

Dash No.	W Max	X Max	Y Max	Z Max	Cable Range	
					Min**	Max
03*	.437 (11.1)	.760 (19.3)	.843 (21.4)	.630 (16.0)	.156 (4.0)	.250 (6.4)
04*	.437 (11.1)	.760 (19.3)	.906 (23.0)	.755 (19.2)	.188 (4.8)	.312 (7.9)
06*	.500 (12.7)	.760 (19.3)	1.093 (27.8)	.942 (23.9)	.281 (7.1)	.438 (11.1)
08	.563 (14.3)	.760 (19.3)	1.187 (30.1)	1.067 (27.1)	.344 (8.7)	.562 (14.3)
10	.563 (14.3)	.760 (19.3)	1.281 (32.5)	1.192 (30.3)	.375 (9.5)	.625 (15.9)
12	.563 (14.3)	.760 (19.3)	1.500 (38.1)	1.380 (35.1)	.438 (11.1)	.750 (19.1)
16	.656 (16.7)	1.073 (27.3)	1.719 (43.7)	1.535 (39.0)	.562 (14.3)	.938 (23.8)
20	.656 (16.7)	1.323 (33.6)	2.062 (52.4)	1.848 (46.9)	.750 (19.1)	1.250 (31.8)
24	.656 (16.7)	1.323 (33.6)	2.312 (58.7)	2.255 (57.3)	.781 (19.8)	1.375 (34.9)
28	1.188 (30.2)	1.572 (39.9)	2.719 (69.1)	2.505 (63.6)	.969 (24.6)	1.625 (41.3)
32*	1.187 (30.1)	1.572 (39.9)	2.969 (75.4)	2.755 (70.0)	1.125 (28.6)	1.875 (47.6)
40*	1.125 (28.6)	1.572 (39.9)	3.531 (89.7)	3.255 (82.7)	1.469 (37.3)	2.375 (60.3)

* Not available in Style M clamp.

** Not Applicable Style D