

**CONNECTOR
 DESIGNATORS
 A-F-H-L-S
 ROTATABLE
 COUPLING**

**TYPE A OVERALL
 SHIELD TERMINATION**

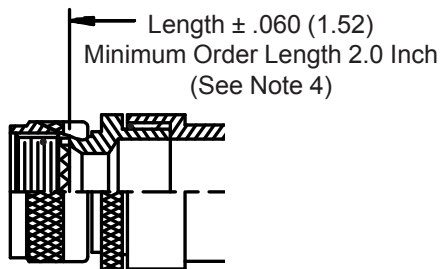

**STYLE 2
 (STRAIGHT)**
 See Note 1)

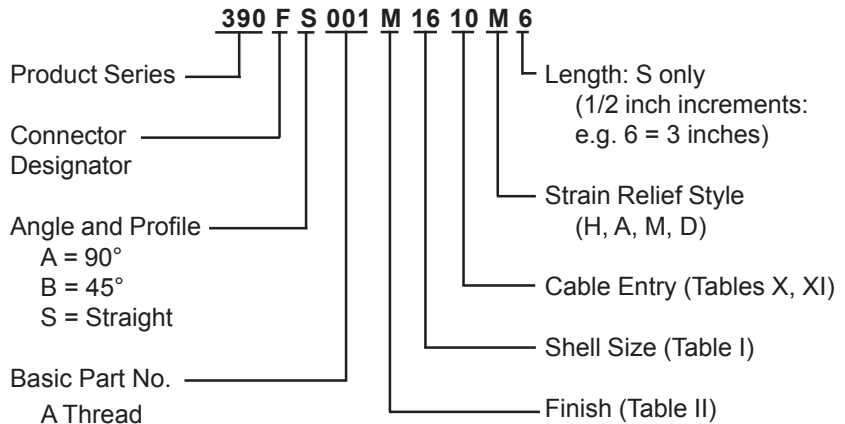
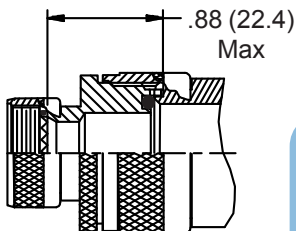

**STYLE 2
 (45° & 90°)**
 See Note 1)



-445 Now Available with the "NESTOR"
 Glenair's Non-Detent, Spring-Loaded, Self-Locking Coupling.
 Add "-445" to Specify This AS85049 Style "N" Coupling Interface.

**STYLE H
 Heavy Duty**
 (Table X)

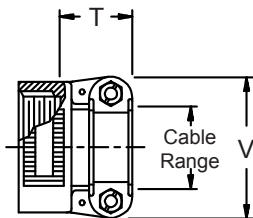

**STYLE A
 Medium Duty**
 (Table XI)

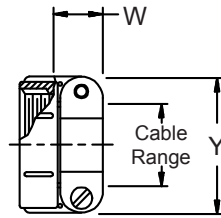

**STYLE M
 Medium Duty**
 (Table XI)

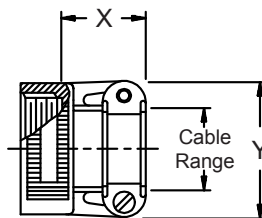

**STYLE D
 Medium Duty**
 (Table XI)

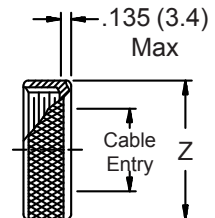

Submersible EMI/RFI Cable Sealing Backshell with Strain Relief Type A - Rotatable Coupling - Low Profile



TABLE III: ELBOW DIMENSIONS

Shell Size		E Max	F Max	G Max	H Max
Conn. Desig.	A-F-L-S H				
08	09	.457 (11.6)	1.760 (44.7)	.500 (12.7)	1.880 (47.8)
10	11	.520 (13.2)	1.920 (48.8)	.595 (15.1)	1.990 (50.5)
12	13	.582 (14.8)	1.990 (50.5)	.610 (15.5)	2.020 (51.3)
14	15	.645 (16.4)	2.144 (54.5)	.700 (17.8)	2.154 (54.7)
16	17	.738 (18.7)	2.254 (57.3)	.885 (22.5)	2.244 (57.0)
18	19	.926 (23.5)	2.444 (62.1)	.975 (24.8)	2.414 (61.3)
20	21	.926 (23.5)	2.444 (62.1)	.975 (24.8)	2.414 (61.3)
22	23	1.020 (25.9)	2.657 (67.5)	1.125 (28.6)	2.587 (65.7)
24	25	1.020 (25.9)	2.657 (67.5)	1.125 (28.6)	2.587 (65.7)
28		1.145 (29.1)	2.690 (68.3)	1.225 (31.1)	2.740 (69.6)
32		1.207 (30.7)	2.790 (70.9)	1.575 (40.0)	2.990 (75.9)
36		1.238 (31.4)	2.930 (74.4)	1.775 (45.1)	3.040 (77.2)

1. When maximum cable entry (page 21) is exceeded, Style 2 will be supplied. Dimensions E, F, G and H will not apply. Please consult factory.
2. Metric dimensions (mm) are indicated in parentheses.
3. Cable range is defined as the accommodations range for the wire bundle or cable. Dimensions shown are not intended for inspection criteria.
4. Consult factory for shorter lengths on straight backshells.
5. Interface O-Ring not supplied with connector designator A.

TABLE X: CABLE ENTRY

Dash No.	T Max	V Max	Cable Range	
			Min	Max
04	.780 (19.8)	.957 (24.3)	.125 (3.2)	.312 (7.9)
06	.780 (19.8)	1.145 (29.1)	.250 (6.4)	.437 (11.1)
08	.780 (19.8)	1.332 (33.8)	.387 (9.8)	.562 (14.3)
10	.780 (19.8)	1.332 (33.8)	.350 (8.9)	.625 (15.9)
12	.811 (20.6)	1.551 (39.4)	.500 (12.7)	.750 (19.1)
16	.905 (23.0)	1.770 (45.0)	.625 (15.9)	.937 (23.8)
20	1.092 (27.7)	2.113 (53.7)	.875 (22.2)	1.250 (31.8)
24	1.124 (28.5)	2.363 (60.0)	1.000 (25.4)	1.375 (34.9)
28	1.399 (35.5)	2.770 (70.4)	1.250 (31.8)	1.625 (41.3)
32	1.399 (35.5)	3.020 (76.7)	1.437 (36.5)	1.875 (47.6)

See inside back cover
fold-out or pages 13 and
14 for Tables I and II.

TABLE XI: CABLE ENTRY

Dash No.	W Max	X Max	Y Max	Z Max	Cable Range	
					Min	Max
03*	.437 (11.1)	.760 (19.3)	.843 (21.4)	.630 (16.0)	.156 (4.0)	.250 (6.4)
04*	.437 (11.1)	.760 (19.3)	.906 (23.0)	.755 (19.2)	.188 (4.8)	.312 (7.9)
06*	.500 (12.7)	.760 (19.3)	1.093 (27.8)	.942 (23.9)	.281 (7.1)	.438 (11.1)
08	.563 (14.3)	.760 (19.3)	1.187 (30.1)	1.067 (27.1)	.387 (9.8)	.562 (14.3)
10	.563 (14.3)	.760 (19.3)	1.281 (32.5)	1.192 (30.3)	.375 (9.5)	.625 (15.9)
12	.563 (14.3)	.760 (19.3)	1.500 (38.1)	1.380 (35.1)	.438 (11.1)	.750 (19.1)
16	.656 (16.7)	1.073 (27.3)	1.719 (43.7)	1.535 (39.0)	.625 (15.9)	.938 (23.8)
20	.656 (16.7)	1.323 (33.6)	2.062 (52.4)	1.848 (46.9)	.875 (22.2)	1.250 (31.8)
24	.656 (16.7)	1.323 (33.6)	2.312 (58.7)	2.255 (57.3)	1.000 (25.4)	1.375 (34.9)
28	1.188 (30.2)	1.572 (39.9)	2.719 (69.1)	2.505 (63.6)	1.250 (31.8)	1.625 (41.3)
32*	1.187 (30.1)	1.572 (39.9)	2.969 (75.4)	2.755 (70.0)	1.437 (36.5)	1.875 (47.6)
40*	1.125 (28.6)	1.572 (39.9)	3.531 (89.7)	3.255 (82.7)	1.875 (47.6)	2.375 (60.3)

* Not available in Style M clamp.