

CONNECTOR DESIGNATORS
A-B*-C-D-E-F
G-H-J-K-L-S

* Conn. Desig. B See Note 5
DIRECT COUPLING

TYPE C OVERALL SHIELD TERMINATION

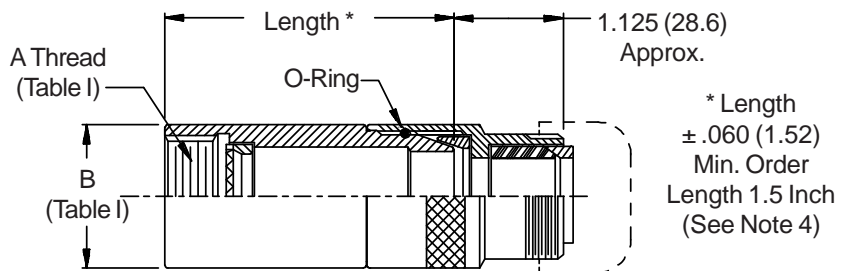
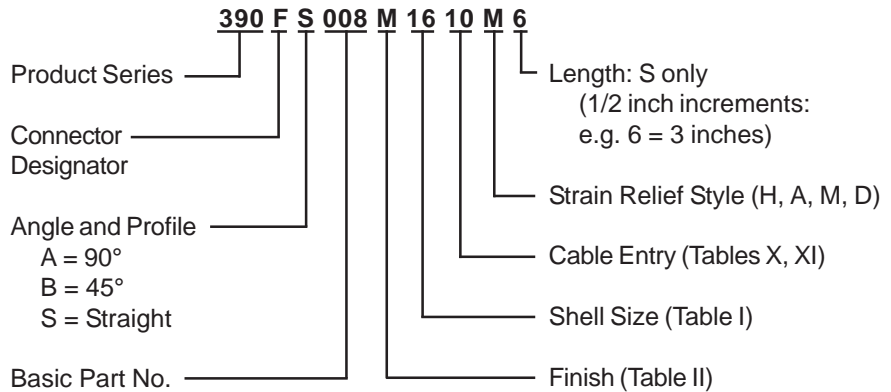
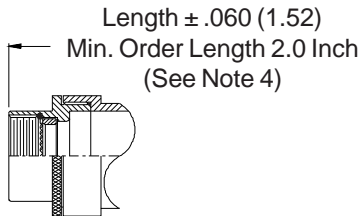

STYLE 2 (STRAIGHT)
 See Note 1)

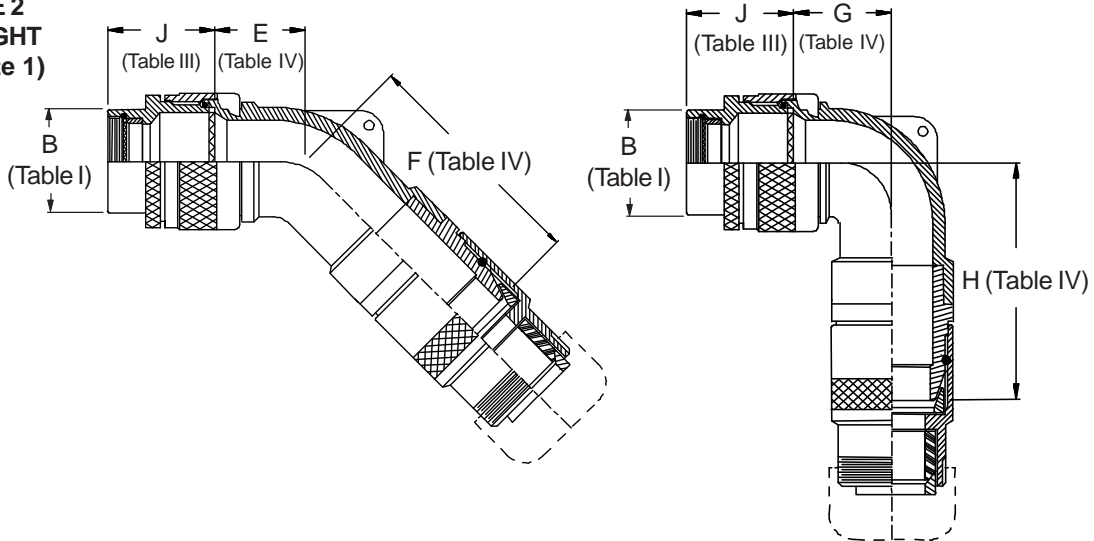

STYLE H
 Heavy Duty
 (Table X)

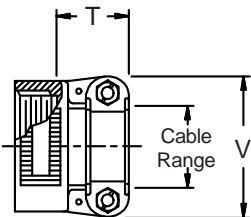

STYLE A
 Medium Duty
 (Table XI)

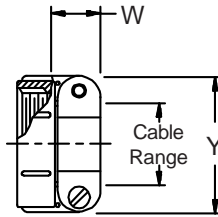

STYLE M
 Medium Duty
 (Table XI)

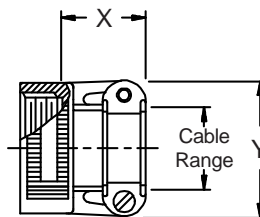

STYLE D
 Medium Duty
 (Table XI)

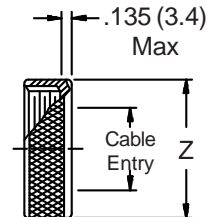

Submersible EMI/RFI Cable Sealing Backshell with Strain Relief Type C - Direct Coupling - Low Profile

See inside back cover fold-out or pages 13 and 14 for Tables I and II.

Shell Size	J Max - Conn. Designator		
	A-E-F		
	J-H-L-S	D-B-G-K	C
08/09	1.180 (30.0)	1.440 (36.6)	
10/11	1.180 (30.0)	1.440 (36.6)	
12/13	1.180 (30.0)	1.440 (36.6)	1.735 (44.1)
14/15	1.180 (30.0)	1.440 (36.6)	1.915 (48.6)
16/17	1.380 (35.0)	1.560 (39.6)	1.915 (48.6)
18/19	1.380 (35.0)	1.560 (39.6)	1.915 (48.6)
20/21	1.380 (35.0)	1.560 (39.6)	1.915 (48.6)
22/23	1.380 (35.0)	1.560 (39.6)	1.915 (48.6)
24/25	1.380 (35.0)	1.560 (39.6)	1.915 (48.6)
28/29	1.610 (40.9)	1.560 (39.6)	1.915 (48.6)
32/33	1.610 (40.9)	1.750 (44.5)	1.915 (48.6)
36	1.610 (40.9)	1.750 (44.5)	1.915 (48.6)
40	1.610 (40.9)	2.190 (55.6)	1.915 (48.6)

Elbow Size	E Max	F Max	G Max	H Max
04	.630 (16.0)	2.715 (69.0)	.636 (16.2)	2.725 (69.2)
06	.630 (16.0)	2.775 (70.5)	.710 (18.0)	2.845 (72.3)
08	.692 (17.6)	2.835 (72.0)	.731 (18.6)	2.865 (72.8)
10	.755 (19.2)	3.554 (90.3)	.825 (21.0)	3.564 (90.5)
12	.848 (21.5)	3.664 (93.1)	.988 (25.1)	3.654 (92.8)
16	1.036 (26.3)	3.854 (97.9)	1.087 (27.6)	3.824 (97.1)
20	1.130 (28.7)	4.192 (106.5)	1.325 (33.7)	4.122 (104.7)
24	1.255 (31.9)	4.225 (107.3)	1.337 (34.0)	4.275 (108.6)
28	1.317 (33.5)	4.325 (109.9)	1.827 (46.4)	4.525 (114.9)
32	1.348 (34.2)	4.465 (113.4)	2.027 (51.5)	4.575 (116.2)

Dash No.	T Max	V Max	Cable Range			
			Min		Max	
04	.780 (19.8)	.957 (24.3)	.125 (3.2)	.312 (7.9)		
06	.780 (19.8)	1.145 (29.1)	.250 (6.4)	.437 (11.1)		
08	.780 (19.8)	1.332 (33.8)	.387 (9.8)	.562 (14.3)		
10	.780 (19.8)	1.332 (33.8)	.350 (8.9)	.625 (15.9)		
12	.811 (20.6)	1.551 (39.4)	.500 (12.7)	.750 (19.1)		
16	.905 (23.0)	1.770 (45.0)	.625 (15.9)	.937 (23.8)		
20	1.092 (27.7)	2.113 (53.7)	.875 (22.2)	1.250 (31.8)		
24	1.124 (28.5)	2.363 (60.0)	1.000 (25.4)	1.375 (34.9)		
28	1.399 (35.5)	2.770 (70.4)	1.250 (31.8)	1.625 (41.3)		
32	1.399 (35.5)	3.020 (76.7)	1.437 (36.5)	1.875 (47.6)		

- When maximum cable entry (page 22) is exceeded, Style 2 will be supplied. (Function S only).
- Metric dimensions (mm) are indicated in parentheses.
- Cable range is defined as the accommodations range for the wire bundle or cable. Dimensions shown are not intended for inspection criteria.
- Consult factory for shorter lengths on straight backshells.
- When using Connector Designator B refer to pages 18 and 19 for part number development.

Dash No.	W Max	X Max	Y Max	Z Max	Cable Range			
					Min		Max	
03*	.437 (11.1)	.760 (19.3)	.843 (21.4)	.630 (16.0)	.156 (4.0)	.250 (6.4)		
04*	.437 (11.1)	.760 (19.3)	.906 (23.0)	.755 (19.2)	.188 (4.8)	.312 (7.9)		
06*	.500 (12.7)	.760 (19.3)	1.093 (27.8)	.942 (23.9)	.281 (7.1)	.438 (11.1)		
08	.563 (14.3)	.760 (19.3)	1.187 (30.1)	1.067 (27.1)	.387 (9.8)	.562 (14.3)		
10	.563 (14.3)	.760 (19.3)	1.281 (32.5)	1.192 (30.3)	.375 (9.5)	.625 (15.9)		
12	.563 (14.3)	.760 (19.3)	1.500 (38.1)	1.380 (35.1)	.438 (11.1)	.750 (19.1)		
16	.656 (16.7)	1.073 (27.3)	1.719 (43.7)	1.535 (39.0)	.625 (15.9)	.938 (23.8)		
20	.656 (16.7)	1.323 (33.6)	2.062 (52.4)	1.848 (46.9)	.875 (22.2)	1.250 (31.8)		
24	.656 (16.7)	1.323 (33.6)	2.312 (58.7)	2.255 (57.3)	1.000 (25.4)	1.375 (34.9)		
28	1.188 (30.2)	1.572 (39.9)	2.719 (69.1)	2.505 (63.6)	1.250 (31.8)	1.625 (41.3)		
32*	1.187 (30.1)	1.572 (39.9)	2.969 (75.4)	2.755 (70.0)	1.437 (36.5)	1.875 (47.6)		
40*	1.125 (28.6)	1.572 (39.9)	3.531 (89.7)	3.255 (82.7)	1.875 (47.6)	2.375 (60.3)		

* Not available in Style M clamp (Style A clamp supplied).