

**STYLE T - TOP ENTRY**

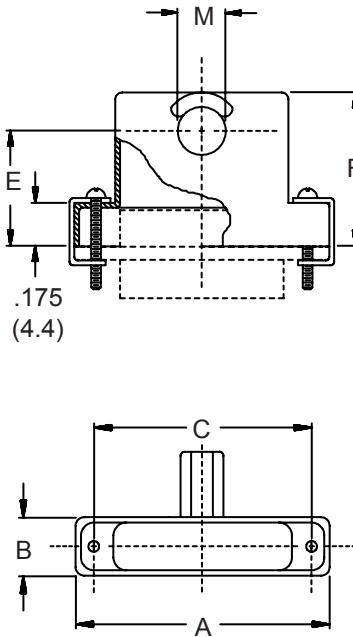

**STYLE S - SIDE ENTRY**



**STYLE E - 45° ENTRY**



Metric dimensions (mm) are indicated in parentheses.

**HOW TO ORDER**

Series	Cable Entry Style	Basic Part Number	Shell Plating *	Shell Size (Table I)	Hardware Options *
500	T – Top S – Side E – 45°	012	C – Black Anodize	09	B – (2) male fillister head E – (2) extended jackscrew H – (2) male hex socket F – (2) female jackpost
			E – Chem. Film	15	
			J – Gold Iridite Over Cadmium Over Electroless Nickel	21	
			M – Electroless Nickel	25	
			NF – Cadmium, Olive Drab Over Electroless Nickel	31	
				37	
			Z2 – Gold	51	
	100				

**Sample Part Number:**

500 T 012 M 21 B

\* SEE PAGE C-4 FOR COMPLETE INFORMATION

Machined aluminum strain relief backshells are intended for applications where shielding is not required.

**TABLE I: DIMENSIONS**

SHELL SIZE	A	B	C	D	E	F
09	.775 (19.7)	.36 (9.1)	.565 (14.4)	.32 (8.1)	.435 (11.0)	.607 (15.4)
15	.925 (23.5)	.36 (9.1)	.715 (18.2)	.44 (11.2)	.440 (11.2)	.643 (16.3)
21	1.075 (27.3)	.36 (9.1)	.865 (22.0)	.56 (14.2)	.458 (11.6)	.677 (17.2)
25	1.175 (29.8)	.36 (9.1)	.965 (24.5)	.62 (15.7)	.483 (12.3)	.718 (18.2)
31	1.325 (33.7)	.36 (9.1)	1.115 (28.3)	.68 (17.3)	.476 (12.1)	.726 (18.4)
37	1.475 (37.5)	.36 (9.1)	1.265 (32.1)	.72 (18.3)	.478 (12.2)	.744 (18.9)
51	1.425 (36.2)	.40 (10.2)	1.215 (30.9)	.75 (19.1)	.548 (13.9)	.829 (21.1)
100	2.160 (54.9)	.45 (11.4)	1.800 (45.7)	.81 (20.6)	.687 (17.4)	.984 (25.0)

SHELL SIZE	G	H REF	J THREAD	K ±.03 (0.8)	L MAX	M Dia ±.005 (0.1)
09	.650 (16.5)	.154 (3.9)	2-56 UNC-2	.70 (17.8)	.90 (22.9)	.156 (4.0)
15	.700 (17.8)	.154 (3.9)	2-56 UNC-2	.82 (20.8)	.96 (24.4)	.188 (4.8)
21	.735 (18.7)	.154 (3.9)	2-56 UNC-2	.94 (23.9)	.99 (25.1)	.219 (5.6)
25	.800 (20.3)	.154 (3.9)	2-56 UNC-2	1.00 (25.4)	1.05 (26.7)	.250 (6.4)
31	.860 (21.8)	.154 (3.9)	2-56 UNC-2	1.06 (26.9)	1.08 (27.4)	.265 (6.7)
37	.925 (23.5)	.154 (3.9)	2-56 UNC-2	1.10 (27.9)	1.12 (28.9)	.281 (7.1)
51	.975 (24.8)	.154 (3.9)	2-56 UNC-2	1.13 (28.7)	1.21 (30.7)	.312 (7.9)
100	1.050 (26.7)	.184 (4.7)	4-40 UNC-2	1.19 (30.2)	1.28 (32.5)	.375 (9.5)

Metric dimensions (mm) are indicated in parentheses.