

370-002
Submersible Cable Sealing Backshell
with Strain Relief
Low Profile - Direct Coupling

CONNECTOR DESIGNATORS
A-B*-C-D-E-F
G-H-J-K-L-S

* Conn. Desig. B See Note 5
DIRECT COUPLING

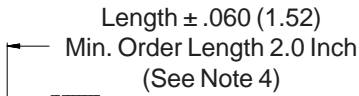

STYLE 2
(STRAIGHT)
 See Note 1)

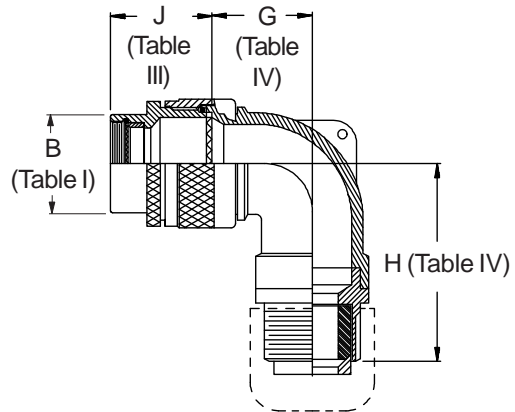
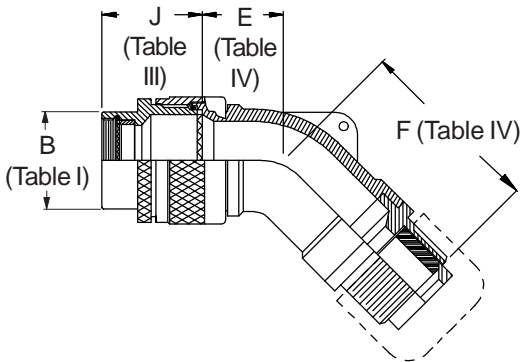

STYLE H
 Heavy Duty
 (Table X)

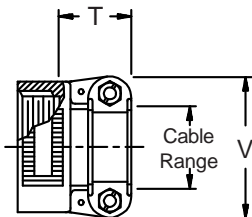

STYLE A
 Medium Duty
 (Table XI)

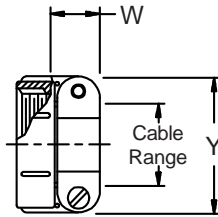

STYLE M
 Medium Duty
 (Table XI)

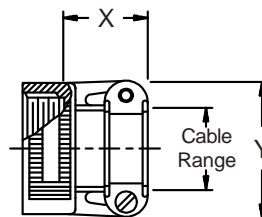

STYLE D
 Medium Duty
 (Table XI)

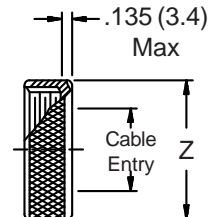

370-002
Submersible Cable Sealing Backshell
with Strain Relief
Low Profile - Direct Coupling



TABLE III: FRONT ADAPTER

Shell Size	J Max - Conn. Designator		
	A-E-F		
	J-H-L-S	D-B-G-K	C
08/09	1.180 (30.0)	1.440 (36.6)	
10/11	1.180 (30.0)	1.440 (36.6)	
12/13	1.180 (30.0)	1.440 (36.6)	1.735 (44.1)
14/15	1.180 (30.0)	1.440 (36.6)	1.915 (48.6)
16/17	1.380 (35.0)	1.560 (39.6)	1.915 (48.6)
18/19	1.380 (35.0)	1.560 (39.6)	1.915 (48.6)
20/21	1.380 (35.0)	1.560 (39.6)	1.915 (48.6)
22/23	1.380 (35.0)	1.560 (39.6)	1.915 (48.6)
24/25	1.380 (35.0)	1.560 (39.6)	1.915 (48.6)
28/29	1.610 (40.9)	1.560 (39.6)	1.915 (48.6)
32/33	1.610 (40.9)	1.750 (44.5)	1.915 (48.6)
36	1.610 (40.9)	1.750 (44.5)	1.915 (48.6)
40	1.610 (40.9)	2.190 (55.6)	1.915 (48.6)

See inside back cover fold-out or pages 13 and 14 for unabridged Tables I and II.

TABLE IV: ELBOW DIMENSIONS

Elbow Size	E Max	F Max	G Max	H Max
04	.567 (14.4)	1.399 (35.5)	.636 (16.2)	1.412 (35.9)
06	.630 (16.0)	1.462 (37.1)	.710 (18.0)	1.532 (38.9)
08	.692 (17.6)	1.524 (38.7)	.731 (18.6)	1.552 (39.4)
10	.755 (19.2)	1.957 (49.7)	.825 (21.0)	1.962 (49.8)
12	.848 (21.5)	2.067 (52.5)	.988 (25.1)	2.052 (52.1)
16	1.036 (26.3)	2.254 (57.3)	1.087 (27.6)	2.227 (56.6)
20	1.130 (28.7)	2.463 (62.6)	1.325 (33.7)	2.395 (60.8)
24	1.255 (31.9)	2.503 (63.6)	1.337 (34.0)	2.548 (64.7)
28	1.317 (33.5)	2.598 (66.0)	1.827 (46.4)	2.798 (71.1)
32	1.348 (34.2)	2.813 (71.5)	2.027 (51.5)	2.818 (71.6)

TABLE X: CABLE ENTRY

Dash No.	T Max	V Max	Cable Range	
			Min	Max
04	.780 (19.8)	.957 (24.3)	.125 (3.2)	.312 (7.9)
06	.780 (19.8)	1.145 (29.1)	.250 (6.4)	.437 (11.1)
08	.780 (19.8)	1.332 (33.8)	.387 (9.8)	.562 (14.3)
10	.780 (19.8)	1.332 (33.8)	.350 (8.9)	.625 (15.9)
12	.811 (20.6)	1.551 (39.4)	.500 (12.7)	.750 (19.1)
16	.905 (23.0)	1.770 (45.0)	.625 (15.9)	.937 (23.8)
20	1.092 (27.7)	2.113 (53.7)	.875 (22.2)	1.250 (31.8)
24	1.124 (28.5)	2.363 (60.0)	1.000 (25.4)	1.375 (34.9)
28	1.399 (35.5)	2.770 (70.4)	1.250 (31.8)	1.625 (41.3)
32	1.399 (35.5)	3.020 (76.7)	1.437 (36.5)	1.875 (47.6)

TABLE II: STANDARD FINISHES

GLENAIR SYMBOL	FINISH
B	Cadmium Plate, Olive Drab
C	Anodize, Black
G	Hard Coat, Anodic
M	Electroless Nickel
NF	Cadmium Plate, Olive Drab Over Electroless Nickel

- When maximum cable entry (page 22) is exceeded, Style 2 will be supplied. (Function S only.)
- Metric dimensions (mm) are indicated in parentheses.
- Cable range is defined as the accommodations range for the wire bundle or

cable. Dimensions shown are not intended for inspection criteria.

- Consult factory for shorter lengths on straight backshells.
- When using Connector Designator B refer to pages 18 and 19 for part number development.

TABLE XI: CABLE ENTRY

Dash No.	W Max	X Max	Y Max	Z Max	Cable Range	
					Min**	Max
03*	.437 (11.1)	.760 (19.3)	.843 (21.4)	.630 (16.0)	.156 (4.0)	.250 (6.4)
04*	.437 (11.1)	.760 (19.3)	.906 (23.0)	.755 (19.2)	.188 (4.8)	.312 (7.9)
06*	.500 (12.7)	.760 (19.3)	1.093 (27.8)	.942 (23.9)	.281 (7.1)	.438 (11.1)
08	.563 (14.3)	.760 (19.3)	1.187 (30.1)	1.067 (27.1)	.387 (9.8)	.562 (14.3)
10	.563 (14.3)	.760 (19.3)	1.281 (32.5)	1.192 (30.3)	.375 (9.5)	.625 (15.9)
12	.563 (14.3)	.760 (19.3)	1.500 (38.1)	1.380 (35.1)	.438 (11.1)	.750 (19.1)
16	.656 (16.7)	1.073 (27.3)	1.719 (43.7)	1.535 (39.0)	.625 (15.9)	.938 (23.8)
20	.656 (16.7)	1.323 (33.6)	2.062 (52.4)	1.848 (46.9)	.875 (22.2)	1.250 (31.8)
24	.656 (16.7)	1.323 (33.6)	2.312 (58.7)	2.255 (57.3)	1.000 (25.4)	1.375 (34.9)
28	1.188 (30.2)	1.572 (39.9)	2.719 (69.1)	2.505 (63.6)	1.250 (31.8)	1.625 (41.3)
32*	1.187 (30.1)	1.572 (39.9)	2.969 (75.4)	2.755 (70.0)	1.437 (36.5)	1.875 (47.6)
40*	1.125 (28.6)	1.572 (39.9)	3.531 (89.7)	3.255 (82.7)	1.875 (47.6)	2.375 (60.3)

* Not available in Style M clamp.

** Not Applicable Style D