

**CONNECTOR  
 DESIGNATORS**  
**A-B\*-C-D-E-F**  
**G-H-J-K-L-S**

\* Conn. Desig. B See Note 5  
**DIRECT  
 COUPLING**

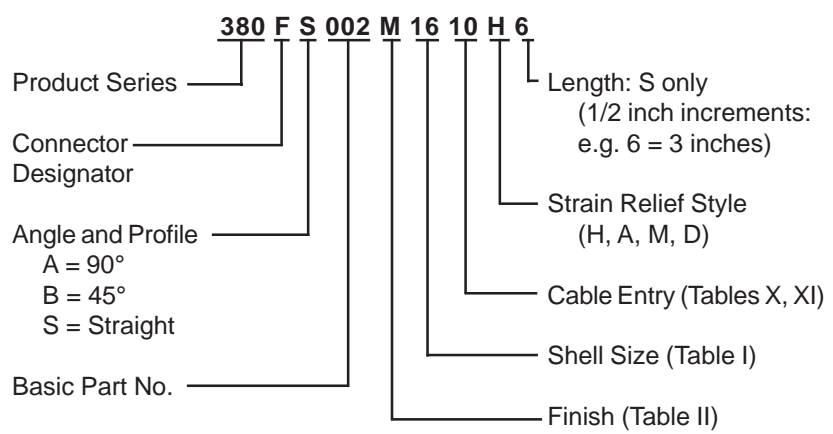

**TYPE A OVERALL  
 SHIELD TERMINATION**

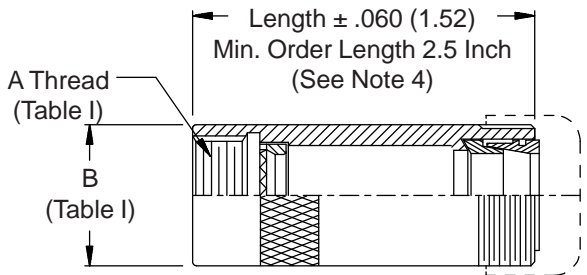
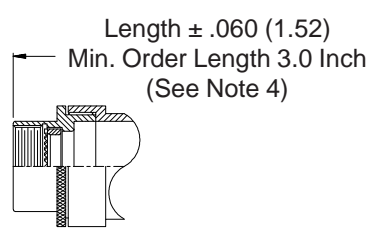

**STYLE 2  
 (STRAIGHT  
 See Note 1)**



**STYLE H  
 Heavy Duty  
 (Table X)**



**STYLE A  
 Medium Duty  
 (Table XI)**



**STYLE M  
 Medium Duty  
 (Table XI)**



**STYLE D  
 Medium Duty  
 (Table XI)**



**380-002**  
**EMI/RFI Non-Environmental Backshell**  
 with Strain Relief  
 Type A - Direct Coupling - Low Profile



**TABLE III: FRONT ADAPTER**

Shell Size	J Max - Conn. Designator		
	A-E-F		
	J-H-L-S	D-B-G-K	C
08/09	1.180 (30.0)	1.440 (36.6)	
10/11	1.180 (30.0)	1.440 (36.6)	
12/13	1.180 (30.0)	1.440 (36.6)	1.735 (44.1)
14/15	1.180 (30.0)	1.440 (36.6)	1.915 (48.6)
16/17	1.380 (35.0)	1.560 (39.6)	1.915 (48.6)
18/19	1.380 (35.0)	1.560 (39.6)	1.915 (48.6)
20/21	1.380 (35.0)	1.560 (39.6)	1.915 (48.6)
22/23	1.380 (35.0)	1.560 (39.6)	1.915 (48.6)
24/25	1.380 (35.0)	1.560 (39.6)	1.915 (48.6)
28/29	1.610 (40.9)	1.560 (39.6)	1.915 (48.6)
32/33	1.610 (40.9)	1.750 (44.5)	1.915 (48.6)
36	1.610 (40.9)	1.750 (44.5)	1.915 (48.6)
40	1.610 (40.9)	2.190 (55.6)	1.915 (48.6)

See inside back cover fold-out or pages 13 and 14 for unabridged Tables I and II.

**TABLE IV: ELBOW DIMENSIONS**

Elbow Size	E Max	F Max	G Max	H Max
04	.567 (14.4)	1.187 (30.1)	.636 (16.2)	1.200 (30.5)
06	.630 (16.0)	1.250 (31.8)	.710 (18.0)	1.320 (33.5)
08	.692 (17.6)	1.312 (33.3)	.731 (18.6)	1.340 (34.0)
10	.755 (19.2)	1.655 (42.0)	.825 (21.0)	1.660 (42.2)
12	.848 (21.5)	1.765 (44.8)	.988 (25.1)	1.750 (44.5)
16	1.036 (26.3)	1.952 (49.6)	1.087 (27.6)	1.925 (48.9)
20	1.130 (28.7)	2.098 (53.3)	1.325 (33.7)	2.033 (51.6)
24	1.255 (31.9)	2.155 (54.7)	1.337 (34.0)	2.200 (55.9)
28	1.317 (33.5)	2.250 (57.2)	1.827 (46.4)	2.450 (62.2)
32	1.348 (34.2)	2.343 (59.5)	2.027 (51.5)	2.450 (62.2)

**TABLE X: CABLE ENTRY**

Dash No.	T Max	V Max	Cable Range	
			Min	Max
			04	.780 (19.8)
06	.780 (19.8)	1.145 (29.1)	.250 (6.4)	.437 (11.1)
08	.780 (19.8)	1.332 (33.8)	.312 (7.9)	.562 (14.3)
10	.780 (19.8)	1.332 (33.8)	.350 (8.9)	.625 (15.9)
12	.811 (20.6)	1.551 (39.4)	.500 (12.7)	.750 (19.1)
16	.905 (23.0)	1.770 (45.0)	.625 (15.9)	.937 (23.8)
20	1.092 (27.7)	2.113 (53.7)	.875 (22.2)	1.250 (31.8)
24	1.124 (28.5)	2.363 (60.0)	1.000 (25.4)	1.375 (34.9)
28	1.399 (35.5)	2.770 (70.4)	1.250 (31.8)	1.625 (41.3)
32	1.399 (35.5)	3.020 (76.7)	1.437 (36.5)	1.875 (47.6)

**TABLE II: STANDARD FINISHES**

GLENAIR SYMBOL	FINISH
B	Cadmium Plate, Olive Drab
M	Electroless Nickel
NF	Cadmium Plate, Olive Drab Over Electroless Nickel

See Inside Back Cover for Additional Finish Options

- When maximum cable entry (page 22) is exceeded, Style 2 will be supplied. (Function S only.)
- Metric dimensions (mm) are indicated in parentheses.
- Cable range is defined as the accommodations range for the wire bundle or cable. Dimensions shown are not intended for inspection criteria.

**TABLE XI: CABLE ENTRY**

Dash No.	W Max	X Max	Y Max	Z Max	Cable Range	
					Min **	Max
					03*	.437 (11.1)
04*	.437 (11.1)	.760 (19.3)	.906 (23.0)	.755 (19.2)	.188 (4.8)	.312 (7.9)
06*	.500 (12.7)	.760 (19.3)	1.093 (27.8)	.942 (23.9)	.281 (7.1)	.438 (11.1)
08	.563 (14.3)	.760 (19.3)	1.187 (30.1)	1.067 (27.1)	.344 (8.7)	.562 (14.3)
10	.563 (14.3)	.760 (19.3)	1.281 (32.5)	1.192 (30.3)	.375 (9.5)	.625 (15.9)
12	.563 (14.3)	.760 (19.3)	1.500 (38.1)	1.380 (35.1)	.438 (11.1)	.750 (19.1)
16	.656 (16.7)	1.073 (27.3)	1.719 (43.7)	1.535 (39.0)	.562 (14.3)	.938 (23.8)
20	.656 (16.7)	1.323 (33.6)	2.062 (52.4)	1.848 (46.9)	.750 (19.1)	1.250 (31.8)
24	.656 (16.7)	1.323 (33.6)	2.312 (58.7)	2.255 (57.3)	.781 (19.8)	1.375 (34.9)
28	1.188 (30.2)	1.572 (39.9)	2.719 (69.1)	2.505 (63.6)	.969 (24.6)	1.625 (41.3)
32*	1.187 (30.1)	1.572 (39.9)	2.969 (75.4)	2.755 (70.0)	1.125 (28.6)	1.875 (47.6)
40*	1.125 (28.6)	1.572 (39.9)	3.531 (89.7)	3.255 (82.7)	1.469 (37.3)	2.375 (60.3)

\* Not available in Style M clamp.      \*\* Not Applicable Style D

- Consult factory for shorter lengths on straight backshells.
- Refer to pages 18 and 19 for connector designator B part number development.