



# 380-099 Composite Cone and Ring Style EMI/RFI Shield Termination Backshell with Self-Locking Coupling Nut and Strain Relief

A

CONNECTOR DESIGNATOR:	
<b>A</b>	MIL-DTL-5015, -26482 Series II, and -83723 Series I and III
<b>F</b>	MIL-DTL-38999 Series I, II
<b>L</b>	MIL-DTL-38999 Series 1.5 (JN1003)
<b>H</b>	MIL-DTL-38999 Series III and IV
<b>G</b>	MIL-DTL-28840
<b>U</b>	DG123 and DG123A
<b>SELF-LOCKING</b>	
<b>ROTATABLE COUPLING</b>	
<b>STANDARD PROFILE</b>	

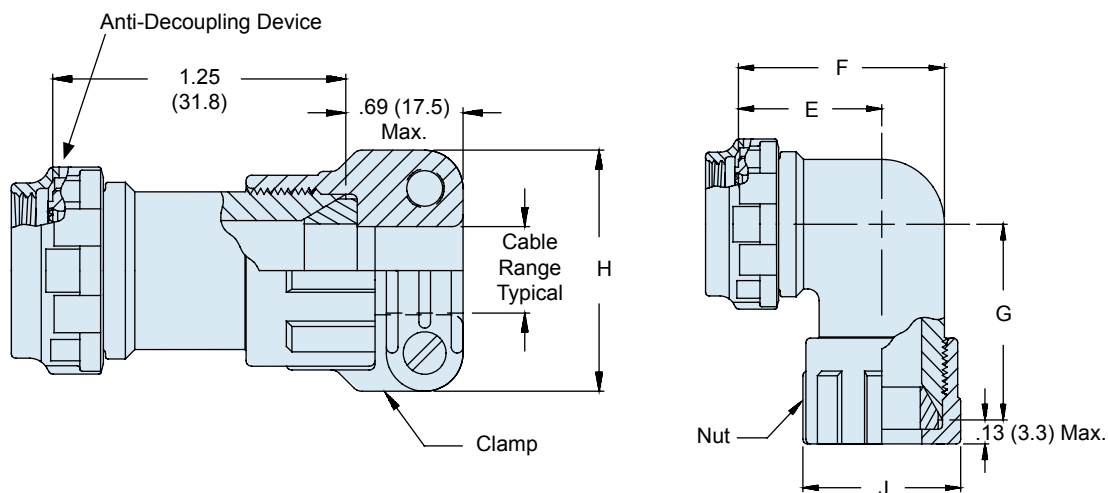
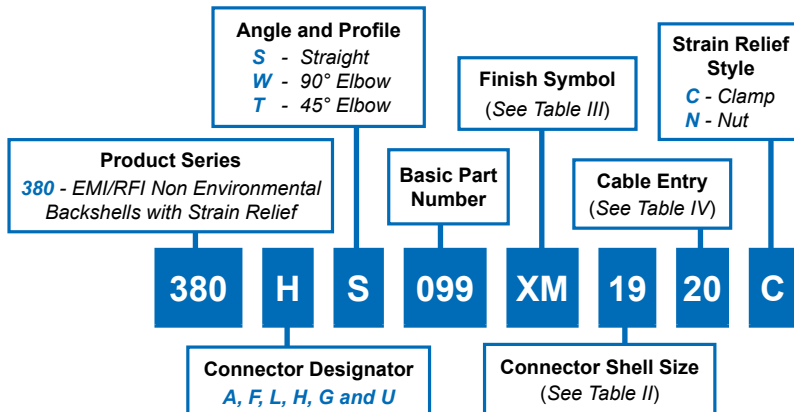

TABLE II: CONNECTOR SHELL SIZE

Shell Size For Connector Designator		E	F	G	Max Entry
A	F/L H G U	±.06 (1.5)	±.09 (2.3)	±.09 (2.3)	Dash No.**
08	08 09 - -	.69 (17.5)	.88 (22.4)	1.19 (30.2)	10
10	10 11 - 08	.75 (19.1)	1.00 (25.4)	1.25 (31.8)	12
12	12 13 11 10	.81 (20.6)	1.13 (28.7)	1.31 (33.3)	14
14	14 15 13 12	.88 (22.4)	1.31 (33.3)	1.38 (35.1)	16
16	16 17 15 14	.94 (23.9)	1.38 (35.1)	1.44 (36.6)	20
18	18 19 17 16	.97 (24.6)	1.44 (36.6)	1.47 (37.3)	20
20	20 21 19 18	1.06 (26.9)	1.63 (41.4)	1.56 (39.6)	22
22	22 23 - 20	1.13 (28.7)	1.75 (44.5)	1.63 (41.4)	24
24	24 25 23 22	1.19 (30.2)	1.88 (47.8)	1.69 (42.9)	28
28	- - 25 24	1.34 (34.0)	2.13 (54.1)	1.78 (45.2)	32

\*\*Consult factory for additional entry sizes available.  
See Introduction for additional connector front-end details.

TABLE III: FINISH

Symbol	Finish Description
XM	2000 Hour Corrosion Resistant Electroless Nickel
XMT	2000 Hour Corrosion Resistant Ni-PTFE, Nickel-Fluorocarbon Polymer. 1000 Hour Grey™
XW	2000 Hour Corrosion Resistant Cadmium/Olive Drab over Electroless Nickel

**380-099**  
**Composite Cone and Ring Style**  
**EMI/RFI Shield Termination Backshell**  
**with Self-Locking Coupling Nut and Strain Relief Clamp**



Composite Backshells

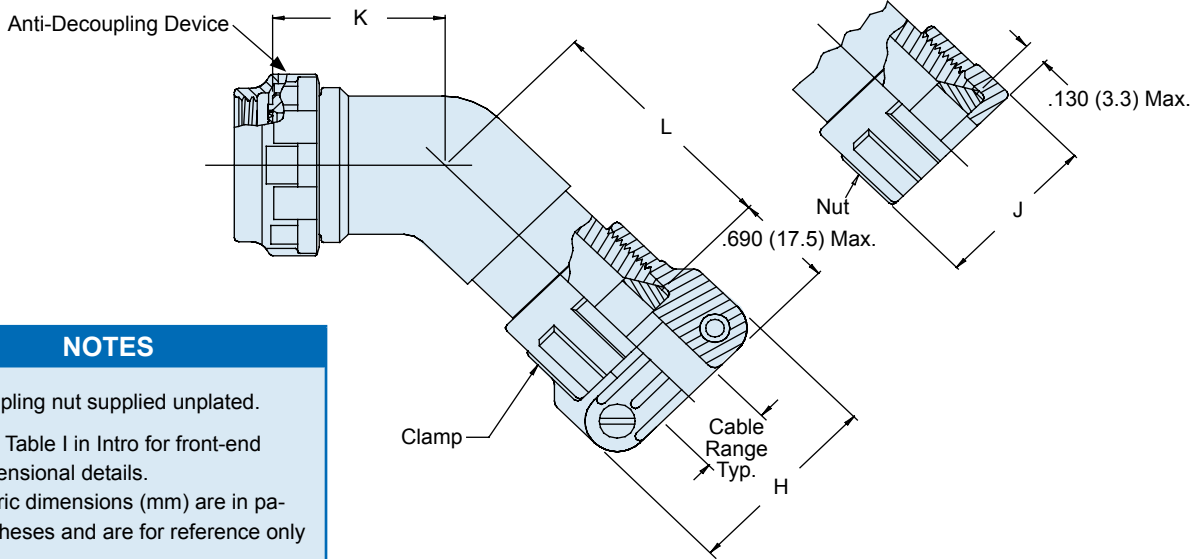

**A**

- NOTES**
1. Coupling nut supplied unplated.
  2. See Table I in Intro for front-end dimensional details.
  3. Metric dimensions (mm) are in parentheses and are for reference only

**TABLE II: CONNECTOR SHELL SIZE (CONT.)**

Shell Size For Connector Designator		K		L		Max Entry Dash No. *
A & F/L	H	±.06	(1.5)	±.06	(1.5)	
08	09	.72	(18.3)	.88	(22.4)	10
10	11	.75	(19.1)	.94	(23.9)	12
12	13	.75	(19.1)	1.00	(25.4)	14
14	15	.76	(19.3)	1.03	(26.2)	16
16	17	.78	(19.8)	1.06	(26.9)	20
18	19	.79	(20.1)	1.07	(27.2)	20
20	21	.82	(20.8)	1.09	(27.7)	22
22	23	.86	(21.8)	1.14	(29.0)	24
24	25	.92	(23.4)	1.17	(29.7)	28

\* Consult factory for additional entry sizes available.

**TABLE IV: CABLE ENTRY**

Dash No.	H		J		Cable Range *			
	±.06	(1.5)	±.06	(1.5)	Minimum		Maximum	
10	.94	(23.9)	.80	(20.3)	.20	(5.1)	.25	(6.4)
12	1.17	(29.7)	.93	(23.6)	.29	(5.1)	.38	(9.7)
14	1.28	(32.5)	1.06	(26.9)	.40	(10.1)	.44	(11.2)
16	1.41	(35.8)	1.22	(31.0)	.48	(12.2)	.63	(15.9)
18	1.50	(38.1)	1.24	(31.5)	.55	(14.0)	.69	(17.5)
20	1.56	(39.6)	1.37	(34.8)	.64	(16.3)	.75	(19.1)
22	1.69	(42.9)	1.49	(37.8)	.72	(18.3)	.88	(22.2)
24	1.81	(46.0)	1.62	(41.1)	.79	(20.0)	1.00	(25.4)
28	1.91	(48.5)	1.68	(42.7)	.89	(20.3)	1.13	(28.6)
32	2.02	(51.3)	1.82	(46.2)	.96	(24.4)	1.25	(31.8)

\* Cable range equals diameter of cable outer jacket.