

**CONNECTOR
 DESIGNATORS
 A-B*-C-D-E-F
 G-H-J-K-L-S**

* Conn. Desig. B See Note 6
DIRECT COUPLING

**TYPE A OVERALL
 SHIELD TERMINATION**

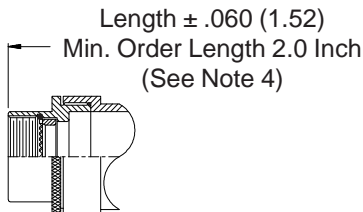
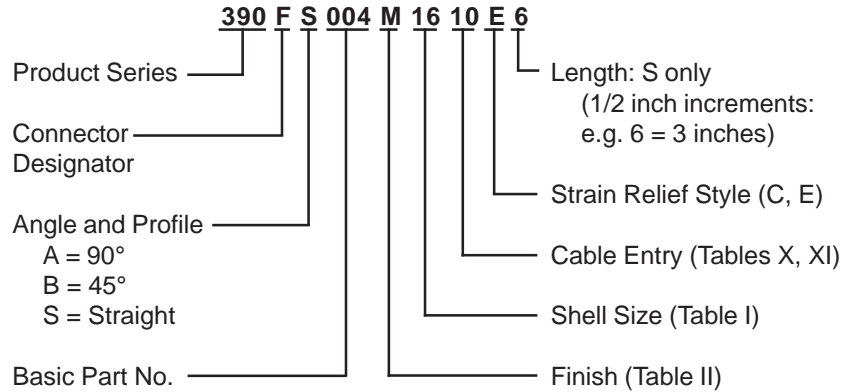

**STYLE 2
 (STRAIGHT)**
 See Note 1)

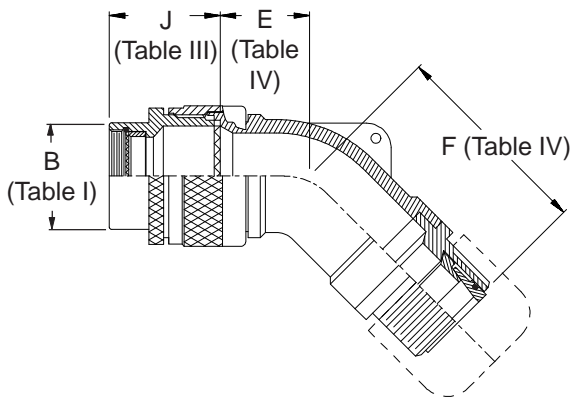
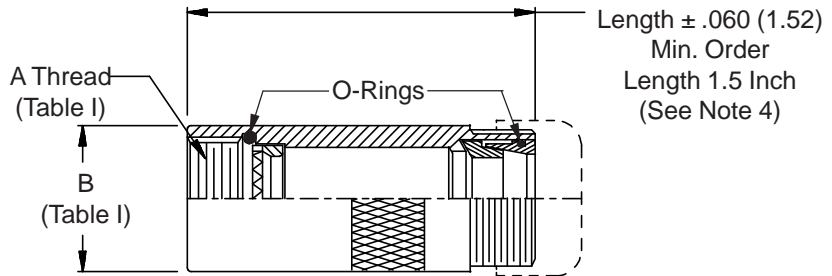

**STYLE C
 Medium Duty**
 (Table X)

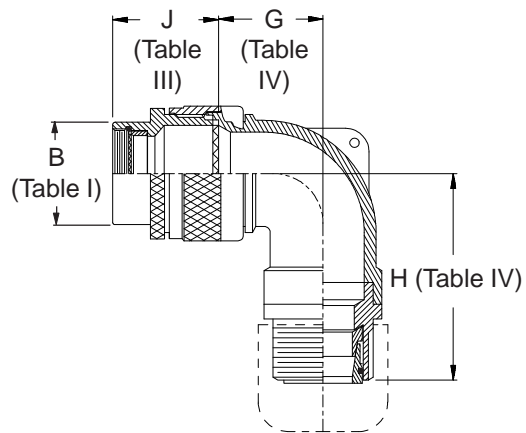

**STYLE E
 Medium Duty**
 (Table XI)

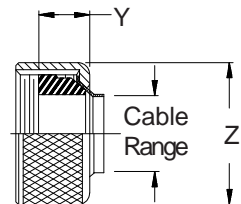
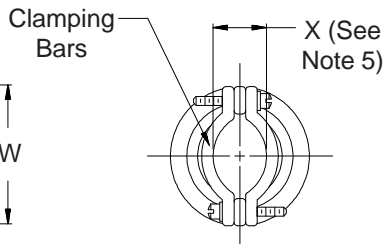
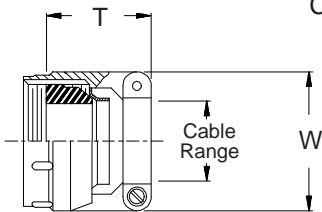

390-004
Water-Tight EMI/RFI Cable Sealing Backshell
 with Strain Relief
 Type A - Direct Coupling - Low Profile



See inside back cover fold-out or pages 13 and 14 for Tables I and II.

TABLE III: FRONT ADAPTER			
Shell Size	J Max - Conn. Designator		
	A-E-F	D-B-G-K	C
	J-H-L-S		
08/09	1.180 (30.0)	1.440 (36.6)	
10/11	1.180 (30.0)	1.440 (36.6)	
12/13	1.180 (30.0)	1.440 (36.6)	1.735 (44.1)
14/15	1.180 (30.0)	1.440 (36.6)	1.915 (48.6)
16/17	1.380 (35.0)	1.560 (39.6)	1.915 (48.6)
18/19	1.380 (35.0)	1.560 (39.6)	1.915 (48.6)
20/21	1.380 (35.0)	1.560 (39.6)	1.915 (48.6)
22/23	1.380 (35.0)	1.560 (39.6)	1.915 (48.6)
24/25	1.380 (35.0)	1.560 (39.6)	1.915 (48.6)
28/29	1.610 (40.9)	1.560 (39.6)	1.915 (48.6)
32/33	1.610 (40.9)	1.750 (44.5)	1.915 (48.6)
36	1.610 (40.9)	1.750 (44.5)	1.915 (48.6)
40	1.610 (40.9)	2.190 (55.6)	1.915 (48.6)

TABLE IV: ELBOW DIMENSIONS						
Dash No.	E Max	F Max	G Max	H Max		
04	.630 (16.0)	1.250 (31.8)	.636 (16.2)	1.200 (30.5)		
06	.630 (16.0)	1.250 (31.8)	.710 (18.0)	1.320 (33.5)		
08	.692 (17.6)	1.312 (33.3)	.731 (18.6)	1.340 (34.0)		
10	.755 (19.2)	1.655 (42.0)	.825 (21.0)	1.660 (42.2)		
12	.848 (21.5)	1.765 (44.8)	.988 (25.1)	1.750 (44.5)		
16	1.036 (26.3)	1.952 (49.6)	1.087 (27.6)	1.925 (48.9)		
20	1.130 (28.7)	2.098 (53.3)	1.325 (33.7)	2.033 (51.6)		
24	1.255 (31.9)	2.155 (54.7)	1.337 (34.0)	2.250 (57.2)		
28	1.317 (33.5)	2.250 (57.2)	1.827 (46.4)	2.450 (62.2)		
32	1.348 (34.2)	2.343 (59.5)	2.027 (51.5)	2.450 (62.2)		

TABLE X: CABLE ENTRY						
Dash No.	T Max	W Max	X Ref	Cable Range		
				Min	Max	
03	1.219 (31.0)	.812 (20.6)	.135 (3.4)	.156 (4.0)	.219 (5.6)	
04	1.219 (31.0)	.937 (23.8)	.203 (5.2)	.188 (4.8)	.312 (7.9)	
06	1.219 (31.0)	1.062 (27.0)	.285 (7.2)	.281 (7.1)	.438 (11.1)	
08	1.219 (31.0)	1.188 (30.2)	.350 (8.9)	.312 (7.9)	.531 (13.5)	
10	1.281 (32.5)	1.312 (33.3)	.390 (9.9)	.375 (9.5)	.625 (15.9)	
12	1.281 (32.5)	1.562 (39.7)	.460 (11.7)	.500 (12.7)	.750 (19.1)	
16	1.406 (35.7)	1.750 (44.5)	.510 (13.0)	.625 (15.9)	.938 (23.8)	
20	1.656 (42.1)	2.250 (57.2)	.695 (17.7)	.938 (23.8)	1.250 (31.8)	
24	1.906 (48.4)	2.375 (60.3)	.715 (18.2)	1.000 (25.4)	1.375 (34.9)	
28	1.906 (48.4)	2.625 (66.7)	.915 (23.2)	1.250 (31.8)	1.625 (41.3)	
32	2.000 (50.8)	2.812 (71.4)	1.070 (27.2)	1.500 (38.1)	1.875 (47.6)	

TABLE XI: CABLE ENTRY				
Dash No.	Y Max	Z Max	Cable Range	
			Min	Max
03	.739 (18.8)	.812 (20.6)	.156 (4.0)	.219 (5.6)
04	.739 (18.8)	.937 (23.8)	.188 (4.8)	.312 (7.9)
06	.739 (18.8)	1.062 (27.0)	.281 (7.1)	.438 (11.1)
08	.739 (18.8)	1.188 (30.2)	.312 (7.9)	.531 (13.5)
10	.791 (20.1)	1.312 (33.3)	.375 (9.5)	.625 (15.9)
12	.880 (22.4)	1.562 (39.7)	.500 (12.7)	.750 (19.1)
16	.901 (22.9)	1.750 (44.5)	.625 (15.9)	.938 (23.8)
20	1.031 (26.2)	2.250 (57.2)	.938 (23.8)	1.250 (31.8)
24	1.250 (31.8)	2.375 (60.3)	1.000 (25.4)	1.375 (34.9)
28	1.250 (31.8)	2.625 (66.7)	1.250 (31.8)	1.625 (41.3)
32	1.312 (33.3)	2.812 (71.4)	1.500 (38.1)	1.875 (47.6)

- When maximum cable entry (page 22) is exceeded, Style 2 will be supplied. (Function S only).
- Metric dimensions (mm) are indicated in parentheses.
- Cable range is defined as the accommodations range for the wire bundle or cable. Dimensions shown are not intended for inspection criteria.
- Consult factory for shorter lengths on straight backshells.
- Saddles are bottomed on Clamp Ears.
- When using Connector Designator B refer to pages 18 and 19 for part number development.