

**CONNECTOR DESIGNATORS**  
**A-B\*-C-D-E-F**  
**G-H-J-K-L-S**

\* Conn. Desig. B See Note 5  
**DIRECT COUPLING**

Length ± .060 (1.52)

Min. Order Length 2.0 Inch  
 (See Note 4)

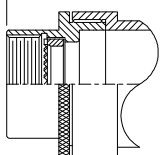

**STYLE 2**  
 (STRAIGHT - See Note 1)

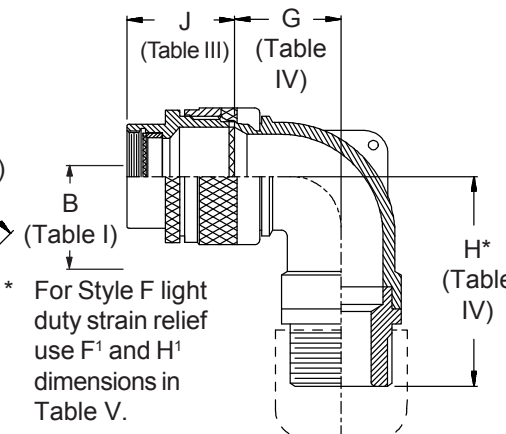
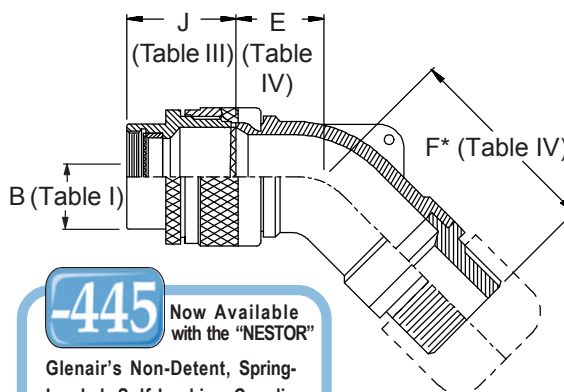
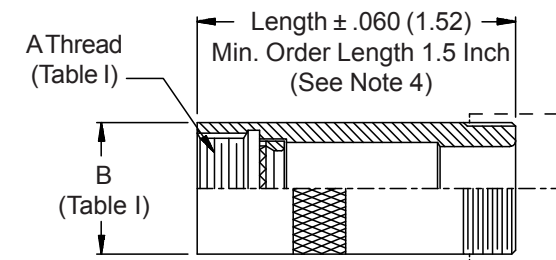
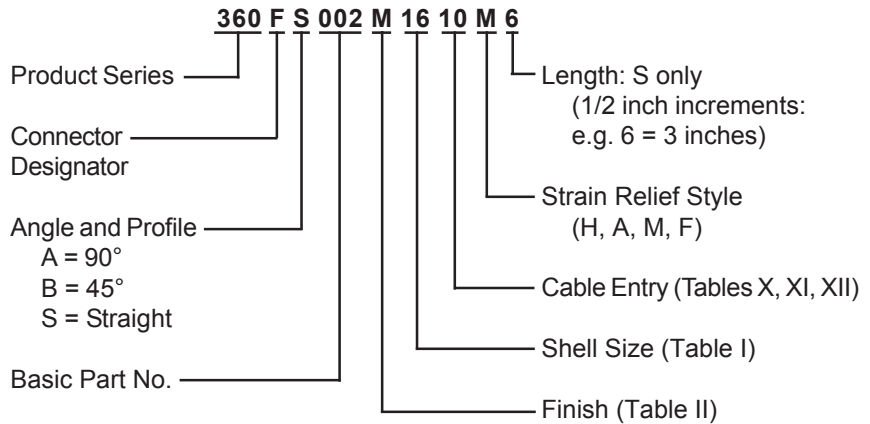

\* For Style F light duty strain relief use F<sup>1</sup> and H<sup>1</sup> dimensions in Table V.

1. When maximum cable entry (page 22) is exceeded, Style 2 will be supplied. (straight only.)
2. Metric dimensions (mm) are indicated in parentheses.
3. Cable range is defined as the accommodations range for the wire bundle or cable. Dimensions shown are not intended for inspection criteria.
4. Consult factory for shorter lengths on straight backshells.
5. When using Connector Designator B refer to pages 18 and 19 for part number development.

**-445** Now Available with the "NESTOR"  
 Glenair's Non-Detent, Spring-Loaded, Self-Locking Coupling. Add "-445" to Specify This AS85049 Style "N" Coupling Interface.

**STYLE H**  
 Heavy Duty  
 (Table X)

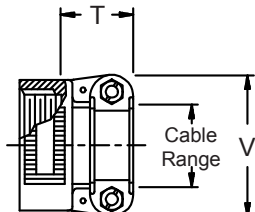

**STYLE A**  
 Medium Duty  
 (Table XI)

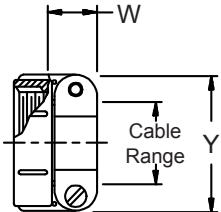

**STYLE M**  
 Medium Duty  
 (Table XI)

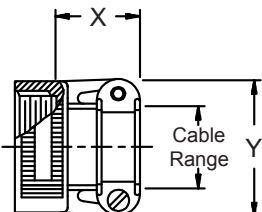

**STYLE F**  
 Light Duty  
 (Table XII)

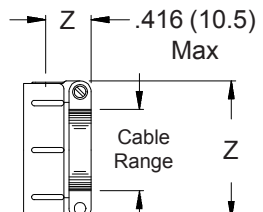

# 360-002 Non-Environmental Backshell with Strain Relief Low Profile - Direct Coupling



TABLE III: FRONT ADAPTER			
Shell Size	J Max - Conn. Designator		
	A-E-F		
	J-H-L-S	D-B-G-K	C
08/09	1.180 (30.0)	1.440 (36.6)	
10/11	1.180 (30.0)	1.440 (36.6)	
12/13	1.180 (30.0)	1.440 (36.6)	1.735 (44.1)
14/15	1.180 (30.0)	1.440 (36.6)	1.915 (48.6)
16/17	1.380 (35.0)	1.560 (39.6)	1.915 (48.6)
18/19	1.380 (35.0)	1.560 (39.6)	1.915 (48.6)
20/21	1.380 (35.0)	1.560 (39.6)	1.915 (48.6)
22/23	1.380 (35.0)	1.560 (39.6)	1.915 (48.6)
24/25	1.380 (35.0)	1.560 (39.6)	1.915 (48.6)
28/29	1.610 (40.9)	1.560 (39.6)	1.915 (48.6)
32/33	1.610 (40.9)	1.750 (44.5)	1.915 (48.6)
36	1.610 (40.9)	1.750 (44.5)	1.915 (48.6)
40	1.610 (40.9)	2.190 (55.6)	1.915 (48.6)

See inside back cover fold-out or pages 13 and 14 for unabridged Tables I and II.

TABLE IV: ELBOW DIMENSIONS				
Elbow Size	E	F	G	H
	Max	Max	Max	Max
04	.567 (14.4)	1.187 (30.1)	.636 (16.2)	1.200 (30.5)
06	.630 (16.0)	1.250 (31.8)	.710 (18.0)	1.320 (33.5)
08	.692 (17.6)	1.312 (33.3)	.731 (18.6)	1.340 (34.0)
10	.755 (19.2)	1.655 (42.0)	.825 (21.0)	1.660 (42.2)
12	.848 (21.5)	1.765 (44.8)	.988 (25.1)	1.950 (49.5)
16	1.036 (26.3)	1.952 (49.6)	1.087 (27.6)	2.033 (51.6)
20	1.130 (28.7)	2.098 (53.3)	1.325 (33.7)	2.033 (51.6)
24	1.255 (31.9)	2.155 (54.7)	1.337 (34.0)	2.200 (55.9)
28	1.317 (33.5)	2.250 (57.2)	1.827 (46.4)	2.450 (62.2)
32	1.348 (34.2)	2.343 (59.5)	2.027 (51.5)	2.450 (62.2)

TABLE X: CABLE ENTRY					
Dash No.	T Max	V Max	Cable Range		
			Min	Max	
04	.780 (19.8)	.957 (24.3)	.125 (3.2)	.312 (7.9)	
06	.780 (19.8)	1.145 (29.1)	.250 (6.4)	.437 (11.1)	
08	.780 (19.8)	1.332 (33.8)	.312 (7.9)	.562 (14.3)	
10	.780 (19.8)	1.332 (33.8)	.350 (8.9)	.625 (15.9)	
12	.811 (20.6)	1.551 (39.4)	.500 (12.7)	.750 (19.1)	
16	.905 (23.0)	1.770 (45.0)	.625 (15.9)	.937 (23.8)	
20	1.092 (27.7)	2.113 (53.7)	.875 (22.2)	1.250 (31.8)	
24	1.124 (28.5)	2.363 (60.0)	1.000 (25.4)	1.375 (34.9)	
28	1.399 (35.5)	2.770 (70.4)	1.250 (31.8)	1.625 (41.3)	
32	1.399 (35.5)	3.020 (76.7)	1.437 (36.5)	1.875 (47.6)	

TABLE XII: CABLE ENTRY					
Dash No.	Z Max	Cable Range			
		Min	Max		
02	.968 (24.6)	.125 (3.2)	.250 (6.4)	.375 (9.5)	
03	1.046 (26.6)	.250 (6.4)	.375 (9.5)	.500 (12.7)	
04	1.156 (29.4)	.312 (7.9)	.500 (12.7)	.625 (15.9)	
05	1.218 (30.9)	.437 (11.1)	.625 (15.9)	.750 (19.1)	
06	1.343 (34.1)	.562 (14.3)	.750 (19.1)	.875 (22.2)	
07	1.468 (37.3)	.687 (17.4)	.875 (22.2)	1.000 (25.4)	
08	1.593 (40.5)	.812 (20.6)	1.000 (25.4)	1.250 (31.8)	
10	1.843 (46.8)	1.062 (27.0)	1.250 (31.8)	1.500 (38.1)	

TABLE XI: CABLE ENTRY						
Dash No.	W Max	X Max	Y Max	Cable Range		
				Min	Max	
03*	.437 (11.1)	.760 (19.3)	.843 (21.4)	.156 (4.0)	.250 (6.4)	
04*	.437 (11.1)	.760 (19.3)	.906 (23.0)	.188 (4.8)	.312 (7.9)	
06*	.500 (12.7)	.760 (19.3)	1.093 (27.8)	.281 (7.1)	.438 (11.1)	
08	.563 (14.3)	.760 (19.3)	1.187 (30.1)	.344 (8.7)	.562 (14.3)	
10	.563 (14.3)	.760 (19.3)	1.281 (32.5)	.375 (9.5)	.625 (15.9)	
12	.563 (14.3)	.760 (19.3)	1.500 (38.1)	.438 (11.1)	.750 (19.1)	
16	.656 (16.7)	1.073 (27.3)	1.719 (43.7)	.562 (14.3)	.938 (23.8)	
20	.656 (16.7)	1.323 (33.6)	2.062 (52.4)	.750 (19.1)	1.250 (31.8)	
24	.656 (16.7)	1.323 (33.6)	2.312 (58.7)	.781 (19.8)	1.375 (34.9)	
28	1.188 (30.2)	1.572 (39.9)	2.719 (69.1)	.969 (24.6)	1.625 (41.3)	
32*	1.187 (30.1)	1.572 (39.9)	2.969 (75.4)	1.125 (28.6)	1.875 (47.6)	
40*	1.125 (28.6)	1.572 (39.9)	3.531 (89.7)	1.469 (37.3)	2.375 (60.3)	

\* Not available in Style M clamp.

TABLE V: ELBOW	
Elbow Size	F <sup>1</sup> Max
	04
06	1.610 (40.9)
08	1.670 (42.4)
10	1.760 (44.7)
12	1.870 (47.5)
16	2.060 (52.3)
20	2.210 (56.1)
Elbow Size	H <sup>1</sup> Max
	04
06	1.680 (42.7)
08	1.700 (43.2)
10	1.770 (45.0)
12	1.860 (47.2)
16	2.030 (51.6)
20	2.140 (54.4)