



HIGH-PERFORMANCE

MICRO-D



CONNECTORS AND CABLES

OCTOBER 2013

MIL-DTL-83513
AND
COMMERCIAL

MICRO-D

*High Performance TwistPin
Equipped Connectors and Cables*



The Glenair family of TwistPin equipped Micro-d connectors offer outstanding mating performance, durability and minimal contact resistance. Micro-D Connectors feature High density micro TwistPin contacts set on .050 centers in arrangements from 9 to 130 contacts. They are available with insulated and uninsulated wire, PCB, solder cup and flex terminations and are supplied as QPL or commercial variations. Our Micro-D connectors provide a solution to meet your high-performance requirements including high temperature and hermetic applications and are in stock and available for immediate same day shipment.



Glenair®

Glenair, Inc.
1211 Air Way
Glendale, CA
91201-2497
818-247-6000
sales@glenair.com
www.glenair.com

Section A High-Performance Micro-D Connectors and Cables Table of Contents



| | | |
|---------------------------|---|---|
| Section A Introduction |  | Specifications, Arrangements and References |
| Section B |  | Metal Shell Micro-D for Harnessing Applications |
| Section C |  | Metal Shell Micro-D for Printed Circuit Boards |
| Section D |  | Single Row Low Profile Metal Shell Micro-D |
| Section E |  | Low Profile Metal and Plastic Shell Micro-D |
| Section F |  | Combo Micro-D for High Power |
| Section G |  | Micro-D Filter Connectors |
| Section H |  | Micro-D Hermetic Connectors |
| Section J |  | Well-Master™ 260 High Temperature Micro-D |
| Section K |  | Micro-D Special Applications and Modifications |
| Section L |  | MIL-DTL-83513 Connectors and Hardware |
| Section M |  | Micro-D Backshells |
| Section N |  | Micro-D Sav-Con® Connector Savers and Hardware |
| Section P |  | Micro EdgeBoard / Micro Circular Connectors |
| Section Q |  | Latching MicroStrips |
| Index |  | Part Number Index |

A

B

C

D

E

F

G

H

J

K

L

M

N

P

Q

INDEX

Product Selection Guide

High-Performance Micro-D Connectors and Cables

A

Section B: Metal Shell Micro-D for Harnessing Applications

| | | | | | |
|---|---|---|--|---|---|
|  |  |  |  |  |  |
| GRPM Solder Cup B-2 | GRPM Insulated Wire B-4 | GRPM Uninsulated Wire B-6 | MWDM Solder Cup B-8 | MWDM Insulated Wire B-10 | MWDM Back-To- Backs B-12 |
|  |  |  |  |  |  |
| Shielded Cable Assembly B-14 | MWDM Uninsulated Wire B-19 | GMDR Insulated Wire B-21 | GMDE Environmental B-23 | GSWM SpaceWire B-27 | GMLM MasterLatch B-29 |

Section C: Metal Shell Micro-D for Printed Circuit Boards

| | | | |
|---|---|---|---|
|  |  |  |  |
| GRPM-CBS C-2 | GRPM-CBR C-4 | MWDM-BS C-6 | MWDM-BR C-10 |
|  |  |  |  |
| MWDM-CBR C-14 | MWDM-CBS C-20 | 90° Surface Mount C-28 | GMR7580 C-32 |
|  |  |  | |
| GMR7590 C-36 | GMR7580C C-40 | GMR7590C C-44 | |

Section D: Single Row Low Profile Metal Shell Micro-D

| | | | |
|---|---|--|---|
|  |  |  |  |
| GMSM Solder Cup D-2 | GMSM Pre-Wired D-2 | GMSM Solid Leads D-3 | GMSM Board Mount D-5 |

Product Selection Guide

High-Performance Micro-D Connectors and Cables

Section E: Low Profile Metal and Plastic Shell Micro-D

| | | | | |
|---|---|---|---|---|
|  |  |  |  |  |
| MLDM Metal Shell Solder Cup E-3 | MLDM Metal Shell Pre-Wired E-5 | MLDM Metal Shell Solid Wire E-7 | MLDM Metal Shell Back-to-Back E-9 | MLDM Metal Shell Right Angle PCB E-11 |
|  |  |  |  |  |
| MWDL Plastic Shell Solder Cup E-15 | MWDL Plastic Shell Pre-Wired E-17 | MWDL Plastic Shell Solid Wire E-19 | MWDL Plastic Shell Back-to-Back E-21 | MWDL Plastic Shell Right Angle PCB E-23 |

Section F: Combo Micro-D for High power

| | | |
|--|--|--|
|  |  |  |
| GMPM Solder Cup F-3 | GMPM Pre-Wired F-6 | GMPM Printed Circuit Board F-9 |

Section G: Micro-D Filter Connectors

| | | | |
|---|---|--|---|
|  |  |  |  |
| Solder Cup Filter Connector G-7 | Vertical PCB Micro-D Filter Connector G-9 | Insulated Wire Filter Connector G-14 | In-Line Filter Adapter G-16 |
|  |  |  |  |
| Right Angle PCB Micro-D Filter Connector G-18 | Rear Panel Mount Solder Cup Filter Connector G-22 | Rear Panel Mount Vertical PCB Filter Connector G-24 | Rear Panel Mount Insulated Wire Filter Connector G-26 |
|  |  |  |  |
| Rear Panel Mount Condensed Board Right Angle Filter Connector G-28 | Edge Board Micro-D Filter Connector G-30 | Combo Micro-D Filter connector G-34 | EMI Troubleshooter Kit for Micro-D Connectors G-35 |

Product Selection Guide

High-Performance Micro-D Connectors and Cables

A

Section H: Micro-D Hermetic Connectors

| | | | |
|---|---|--|---|
|  |  |  |  |
| Solder Cup, PC Tail, Insulated Wire H-6 | Shell Size 9-21, Front Mount H-8 | Shell Size 37, Front Mount H-9 | Solder Cup, PC Tail, Insulated Wire H-11 |

Section J: Well-Master™ High Temperature Micro-D

| | | |
|---|---|---|
|  |  |  |
| Pre-Wired J-7 | Back-to-Back J-10 | Right Angle PCB Header J-13 |

Section K: Micro-D Special Applications and Modifications

| | | | |
|--|--|---|--|
|  |  |  |  |
| Mod 474 Keying Option K-2 | Mod 497 Ground Spring K-4 | Mod 428 200°C K-6 | Mod 429 Space Grade K-8 |

Section L: MIL-DTL-83513 Solder Cup and Pre-Wired Connectors and Hardware

| | | | |
|---|---|--|---|
|  |  |  |  |
| Metal Shell L-4 | Plastic Shell L-7 | Board Mount L-10 | Hardware L-26 |

Section M: Micro-D Backshells

| | | | |
|---|---|--|---|
|  |  |  |  |
| Round Entry M-6 | Round Entry Split Shell Banding Backshell M-9 | Round Entry Braid Terminated Backshell M-10 | Round Entry Composite Backshell M-12 |

Product Selection Guide

High-Performance Micro-D Connectors and Cables

Section M: Micro-D Backshells (continued)

| | | | |
|---|---|--|---|
|  |  |  |  |
| Elliptical Entry M-14 | Elliptical Split Banding Backshell M-21 | Strain Relief Backshell M-23 | Potting Shell M-26 |

Section N: Micro-D Sav-Con® Connector Savers and Accessories

| | | | |
|---|---|---|---|
|  |  |  |  |
| Uni-Savers N-2 | Shorting Plug Assemblies N-3 | Anti-Static Dust Caps N-4 | Interfacial Seals N-4 |
|  |  |  | |
| Metal Covers N-5 | Rubber Covers N-9 | Hardware N-10 | |

Section P: Micro EdgeBoard and Micro Circular

| | |
|---|---|
|  |  |
| MWEB P-2 | MWKQ P-10 |

Section Q: Latching MicroStrips

| | | | |
|---|---|--|---|
|  |  |  |  |
| Solder Cup Q-4 | Solid Wire Q-6 | Pre-Wired Q-7 | Right Angle PCB Q-9 |
|  |  |  |  |
| 90° Staggered PCB Q-9 | Vertical PCB Q-9 | Surface PCB Q-13 | Back-to-Back Q-15 |



Six Reasons

To Select a Glenair High- Performance Micro-D Connector...

1 Recognized performance standards.

Every element of the MIL-DTL-83513 Micro-D is exactly controlled—from terminal spacing to approved wire termination methods. The military standard defines contact resistance, dielectric withstanding voltage, corrosion resistance, shock and vibration tolerances and a wide range of other electrical, mechanical and environmental performance standards. Standardized measurement and test methodologies ensure consistent, predictable performance throughout this broad family of ruggedized, miniature connectors.

2 Proven reliability under tough operating conditions.

For applications where interconnect failure is simply not an option, the Glenair high-reliability Micro-D offers a wealth of performance benefits which far outweigh any potential cost savings realized by specifying a lesser caliber connector. If downtime is a critical concern, other connectors cannot match the long-term durability and performance advantages of the MIL-DTL-83513 Micro-D, which include:

- Higher current ratings
- Lower circuit resistance
- Superior vibration and shock
- Optimized EMI/RFI shielding
- Broader operating temperature
- Better damage resistance
- Enhanced corrosion resistance
- Better environmental sealing

3 The flexibility of easy customization.

Manufacturers of satellite communications systems, geophysical exploration devices, medical diagnostics and industrial equipment face many of the same packaging requirements for reduced size, weight and shape as do their military counterparts. And the ability to design-in a wide range of custom modifications which fit the unique packaging requirements of these specialized applications is a distinct advantage of the Glenair Micro-D—making it the connector of choice for many unique or small quantity applications.

4 Advanced, high temperature tolerance.

Heat from electrical or environmental sources can soften mated contacts over time and reduce contact retention force. Under extreme conditions of shock and vibration this loss of normal retention can result in unstable resistance across the interconnect. This is the case for all types of contacts—machined, drawn, stamped and twisted. But materials selection, fabrication and heat treating techniques enable Glenair's TwistPin contact to resist high temperature stress relaxation for up to 1000 hours at 125° C and thus perform at levels unmatched by other contact designs

5 Trouble-free mating and un-mating.

Glenair has perfected a nickel underplating combined with a proprietary duplex gold overplating which provides optimal contact lubricity (anti-galling) and effectively eliminates the oxidation common to copper flash underplating. Glenair's advanced plating process contributes to the overall durability of the connector by reducing contact engaging and separating forces.

6 Fast Turnaround and Same-Day Availability.

Are the Micro-D connectors and accessories you need either in stock or able to be manufactured in a short period of time? Glenair has built its reputation on fast turnaround and can deliver TwistPin products—from discrete connectors to complete assemblies—faster than anyone else in our business. We maintain the world's largest inventory of Micro-D connectors and accessories, all available for immediate shipment with no quantity or price minimums.



Not All Micro-D's Are Created Equally

Seven Points of Electrical Contact

The TwistPin size #24 contact has seven strands of BeCu wire surrounding three filler strands. Each strand makes contact with the socket, assuring low resistance, plenty of contact wipe, and excellent shock and vibration performance.



The MIL-DTL-83513 and MIL-DTL-32139 specifications define the minimum acceptable performance levels for Micro-D and Nanominiature connectors. While the specs are rigid in their performance benchmarks, manufacturers are given considerable leeway when it comes to contact design, crimp fabrication, contact finish and material selection. Stamped and formed contacts, for example, are widely used in Micro-d connectors due to their low-cost and ease of manufacture. But independent testing clearly shows that TwistPin style contacts provide superior performance in such areas as high temperature tolerance, contact retention and crimp strength. If you have already made the decision to use either a Micro-D or Nano sized connector because its ruggedized performance outweighs the potential cost-savings realized in a lesser-caliber connector, then you owe it to yourself to understand the very real differences between stamped pins and the Glenair TwistPin Contact System.

What sets our pins apart

This unretouched photograph shows important differences between the TwistPin and stamped pins.

A Stronger Front End

Both types of contacts meet the requirements of MIL-DTL-83513. But only the TwistPin offers a stronger front-end with its seven points of contact, high normal force and better resistance to vibration.

Stamped Pin



Glenair TwistPin

A Better Crimp Joint

Micro-D connectors are factory-terminated to wire. Board mount and insulated wire pigtails have crimp joints where the wire attaches to the contact. Micro-D crimp joints are concealed with epoxy potting. The Micro-D is unique among high reliability mil spec connectors because the mil spec allows stamped crimp barrels and does not specify that the crimping process must use mil spec crimp tools. The thin sheet metal in the stamped pin cannot produce a satisfactory gas-tight crimp joint, so spot welding is required to reduce the chance of failure.

8 Indent Mil Spec Crimp Joint

"B" Crimp With Spot Weld

M39029 Split Tine
Contact System



Split-Tine Contact Systems

The socket contact is made by machining a copper alloy tube, then cutting a longitudinal slot. The contact is then crimped to bend the tines together. The smallest split tine contact systems are used in connectors with .075 inch spacing. The TwistPin offers improved vibration performance and higher contact density.

The Glenair TwistPin Contact

At-a-Glance



MicroPin



NanoPin



Question: Why choose a TwistPin connector?

Answer: Design Flexibility and Reliable Performance If reliability and performance were the only considerations in the design of a micro contact system, everyone would opt for a TwistPin contact and a machined socket and crimp sleeve. But cost and ease of manufacture are significant issues as well, which is why stamped and formed contacts, as well as split-tine M39029 contacts, are still widely used. The Glenair TwistPin Contact System provides a superior wire attachment which translates to lower contact resistance—and it does so under extreme conditions of vibration, shock and high heat. An additional key benefit of the TwistPin contact is the ease of designing a custom package to fit your exact needs. The precision machined components can be readily integrated into a wide range of connector package envelopes.



TwistPin Contacts

The TwistPin contact is made with a bundle of beryllium copper wires welded at the tip to form a semispherical radius and "bulged" to create a spring.

Inside a Micro-D TwistPin Connector



Four Reasons to Select Glenair for Your Next Micro/Nano Flex Circuit Project

2 Full Spectrum Product Offering

Glenair offers a complete range of miniaturized printed circuit board connectors with high-reliability TwistPin contacts. We supply both through-hole and surface mount designs in every angle and mounting style for integration into single-sided, double-sided and multilayered flex circuitry.

4 Termination Expertise

Glenair's experienced workforce is trained and qualified to produce consistently reliable circuit terminations using the most advanced techniques and technologies, including automated solder reflow systems.

1 Unsurpassed Experience in Micro/Nano Flex Circuit Production

Glenair has been integrating Micro-D and Nanominiature connectors into flex circuitry for over 30 years. Our technical capabilities include design and layout of turnkey assemblies as well as the production of custom-configured micro and nano interconnects for maximum size and weight savings.

3 Application Design

Our turnkey Micro-D and Nanominiature flex circuit assemblies are produced to exacting specifications. Customer-supplied designs are reviewed and revised to insure the most advantageous utilization of EMI shielding, polarization, strain-relief and connector packaging technologies. At Glenair, the final design solution is optimized to meet the exact mechanical and electronic requirements of the application environment.





Micro-D Standard Materials and Finishes

Connector Shell, Metal

Aluminum Alloy 6061 In Accordance With SAE AMS-QQ-A-250/11:

Plating code 1: cadmium with yellow chromate conversion coating in accordance with SAE-AMS-QQ-P-416, Type II, Class 3

Plating code 2: electroless nickel in accordance with ASTM B733

Plating code 4: black anodize in accordance with MIL-A-8625 Type II Class 2

Plating code 5: gold plated in accordance with ASTM B488 over electroless nickel in accordance with ASTM B733-90.

Plating code 6: chem film in accordance with MIL-C-5541 Class 3

Plating code 33: nickel-ptfe in accordance with M83513.

Stainless Steel, 300 Series:

Plating Code 3: Passivated In Accordance With SAE AMS 2700

Connector Shell, Plastic

Liquid crystal polymer, 30% glass-filled or polyphenyl sulfide, 40% glass-filled in accordance with MIL-M-24519

Terminal Block, PCB (LCP & PPS)

Liquid crystal polymer, 30% glass-filled or polyphenyl sulfide, 40% glass-filled in accordance with MIL-M-24519

Interfacial Seal

Fluorosilicone rubber in accordance with A-A-59588

Pin Contact (TwistPin)

Beryllium copper, gold plated in accordance with ASTM B 488 Type II Class 1.27 (50 Microinches minimum) Code C, over nickel underplate in accordance with SAE AMS-QQ-N-290, class 2, (30-150 microinches).

Socket Contact

Phos bronze in accordance with ASTM 139 gold plated in accordance with ASTM B 488 Type II Class 1.27 (50 Microinches minimum) Code C, over nickel underplate in accordance with SAE-AMS-QQ-N-290, Class 2, (30-150 microinches).

Encapsulant (Potting)

Epoxy resin, hysol EE4215/HD3561

Jackscrews, Jackposts, Float Mounts

Stainless steel, 300 series, passivated in accordance with SAE AMS 2700

Pigtail Wire, Insulated Hookup

Wire Type E: silver-coated copper wire, Extruded PTFE insulation, 600 volts rms, 200°c., In accordance with NEMA HP3 (Replaces MIL-W-16878/4) with SAE AS 22759/11

Wire Type K: Silver-Coated Copper Wire, Extruded PTFE insulation, 60 volts RMS, 200° C., in accordance with SAE AS 22759/11

Wire Type J: high-strength silver-coated copper alloy wire, crosslinked modified ETFE insulation, 600 volts rms, 200° c., In accordance with SAE AS 22759/33

Pigtail Wire, Uninsulated

Wire Finish Code 3: solid copper wire in accordance with A-A-59551, gold-plated, solder dipped in 60/40 tin-lead

Wire Finish Code 4: solid copper wire in accordance with A-A-59551, gold-plated

Micro-D Performance Specifications

1 SCOPE

- 1.1 **Scope.** This specification covers performance requirements for Glenair Micro-D connectors manufactured in accordance with MIL-DTL-83513.
- 1.2 **Description.** MWDL plastic and MWDM metal shell Micro-D connectors on .050 inch (1.27 mm) centers, with TwistPin contacts.

2 ORDER OF PRECEDENCE

- 2.1 **Order of precedence.** In the event of a conflict between the requirements of this specification and the references cited herein, this document takes precedence. The requirements set forth in customer specifications and Glenair detail drawings shall take precedence over this document.

3 REQUIREMENTS

3.1 **Electrical Performance Requirements.**

- 3.1.1 **Insulation resistance.** 5,000 megohms minimum between any pair of contacts and any contact and the shell when tested in accordance with EIA-364 Procedure 21, which specifies 500 volts DC.

3.1.2 **Dielectric withstanding voltage.**

- 3.1.2.1 **Dielectric withstanding voltage (sea level).** 600 volts ac, rms 60 Hz. Connectors shall show no evidence of breakdown or flashover when subjected to the DWV test of EIA-364 Procedure 20.
- 3.1.2.2 **Dielectric withstanding voltage (70,000 feet).** 150 volts ac, rms 60 Hz. Connectors shall show no evidence of breakdown or flashover when subjected to the DWV test of EIA-364 Procedure 20.

3.1.3 **Contact resistance**

- 3.1.3.1 **Contact resistance (M83513 Group C qualification).** The voltage drop of a mated pair of contacts attached to wires shall not exceed the values shown when tested in accordance with MIL-DTL-83513F Paragraph 4.5.8, using 2.5 amps test current.

| Wire | Voltage Drop (mV) |
|-------------------|-------------------|
| M22759/11-26 | 65 Maximum |
| M22759/33-26 | 75 Maximum |
| A-A-59551 25 gage | 60 Maximum |

- 3.1.3.2 **Contact resistance (lot acceptance testing).** The voltage drop across a mated pair of contacts shall not exceed 8 millivolts when tested in accordance with EIA-364-06, using a test current of one ampere \pm 2%. If the connector under test is wired, the calculated resistance across the contacts shall not exceed 8 milliohms when the maximum specified wire resistance per foot is subtracted from the total resistance.

- 3.1.4 **Low signal level contact resistance.** When tested with a micro-ohmmeter using a test current of 100 milliamperes maximum and 20 millivolts open circuit maximum, the resistance of a mated pair of contacts shall be 32



Micro-D Performance Specifications

milliohms maximum. Test procedure shall be in accordance with EIA-364-23.

- 3.1.5 **Contact current capability.** Contacts shall be capable of carrying 3.0 amperes in continuous duty operation from -55° C. to +150° C. when tested in accordance with EIA-364-70.
- 3.1.6 **Shell-to-shell conductivity.** A mated pair of nickel-plated metal shell Micro-D connectors fitted with an optional grounding spring on the plug shell mating face, shall not exceed 10 millivolts maximum voltage drop when tested in accordance with EIA-364-83.
- 3.1.7 **Shielding effectiveness.** A mated pair of metal shell Micro-D connectors fitted with an optional grounding spring on the plug shell mating face shall meet a requirement of 65 dB minimum attenuation when tested in accordance with EIA-364-66.
- 3.1.8 **Magnetic permeability.** Magnetic permeability, when tested in accordance with EIA-364-54, shall not exceed 2 mu.

3.2 **Mechanical Requirements**

- 3.2.1 **Contact engaging and separation force.** Maximum engaging force shall be 6.0 ounces when tested in accordance with EIA-364-37, except with a $.0221 \pm .0001$ diameter sleeve with a 6-10 microfinish. Minimum separation force shall be 0.5 ounces when tested in accordance with EIA-364-37, except with a $.0230 \pm .0001$ diameter sleeve with a 6-10 microfinish.
- 3.2.2 **Connector mating and unmating force.** The maximum mating and unmating force shall not exceed a value equal to 10 ounces times the number of contacts, when tested per EIA-364-13. Mate connectors three times before initial measurements are taken.
- 3.2.3 **Contact retention.** Contacts, when tested in accordance with EIA-364-29, shall withstand a 5 pound axial load for a minimum of 5 seconds, with a maximum allowable displacement of .005 inch.
- 3.2.4 **Crimp tensile strength.** Wire shall not break or pull out of crimp joints at less than the specified force when tested in accordance with EIA-364-08.

| Wire | Gage | Force in Pounds |
|-----------|------|-----------------|
| M22759/11 | 24 | 8 |
| M22759/11 | 26 | 5 |
| M22759/11 | 28 | 4 |
| M22759/33 | 24 | 12 |
| M22759/33 | 26 | 10 |
| M22759/33 | 28 | 6 |
| M22759/33 | 30 | 4 |

- 3.2.5 **Insert retention.** Inserts shall not be dislodged or moved from their original position when subjected to an axial load of 50 pounds per square inch when tested in accordance with EIA-364-35
- 3.2.6 **Resistance to soldering heat.** Connectors with solder cup contacts shall not be damaged following soldering with a 360° C. solder iron for at least 4 seconds in accordance with EIA-364-56 Procedure 1. Connectors with printed circuit board terminations shall withstand immersion in a solder bath for 9-11 seconds at 260° C. when

Micro-D Performance Specifications

tested in accordance with EIA-364-56 Procedure 3 Test Condition B. Connectors, after cooling, shall not exhibit damage or warpage when examined at 10X magnification. .

3.2.7 **Solderability.** Solder cup and printed circuit terminals shall meet the solderability requirements of MIL-STD-202 Method 208.

3.2.8 **Durability.** Micro-D connectors shall be capable of 500 cycles of mating with no damage or degradation to electrical performance. Engaging and separation force and mating forces shall not exceed the requirements of 3.2.1 and 3.2.2.

3.3 **Environmental Requirements**

3.3.1 **Salt spray (corrosion).** Connectors shall show no exposure of base metal due to corrosion when subjected to the salt spray test of EIA-364-26. In addition, connectors shall meet contact resistance, lw circuit level contact resistance and mating force requirements.

| Shell material, finish (code) | EIA-364-26 test condition | Duration (hours) |
|---|---------------------------|----------------------|
| Aluminum, cadmium plating (01) | A | 96 (48 for M83513) |
| Aluminum, electroless nickel plating (02) | B | 48 |
| Aluminum, black anodize (04) | B | 48 |
| Aluminum, chem film (06) | B | 48 |
| Aluminum, gold (05) | B | 48 |
| Stainless steel, passivated (03) | D | 1000 (48 for M83513) |
| Nickel, PTFE (33) | T | 500 (48 for M83513) |

3.3.2 **Fluid immersion.** Connectors shall meet mating force requirements following 20 hours immersion in synthetic lubricating oil and 1 hour immersion in coolanol 25, when tested in accordance with MIL-DTL-83513F paragraph 4.5.18.

3.3.3 **Thermal vacuum outgassing.** The assembled connector mass excluding metallic parts shall not exceed 1.0% total mass loss (TML) or 0.1% total volatile condensable materials (CVCM) when tested in accordance with ASTM E595.

NOTE: the interfacial seal on metal shell MWDM receptacle connectors slightly exceeds the allowable CVCM unless it is specially processed. This is acceptable per MIL-DTL-83513 but may not be permissible for specific space programs.



Micro-D Performance Specifications

Outgassing properties of Micro-D components

| Component | Material | Brand Name | %Total Mass Loss (TML) | %Collected Volatile Condensable material (CVCM) | Test Report |
|--|--|---------------|------------------------|---|----------------------|
| Thermoplastic Insulators and, PCB Trays | Liquid Crystal Polymer or Polyphenyl Sulfide | Vectra® C-130 | 0.03 | 0.00 | NASA Test #GSC174 78 |
| Potting Compound | Epoxy | Hysol C9-4215 | 0.48 | 0.01 | Glenair Test |
| Interfacial Seal "as received" | Fluorosilicone | (none) | 0.99 | 0.13 | Glenair Test |
| Interfacial Seal with Oven Bakeout 8 hrs. 400° F. | Fluorosilicone | (none) | 0.03 | 0.01 | Glenair Test |
| Interfacial Seal with Thermal Vacuum Bakeout 24 hrs. 125° C. | Fluorosilicone | (none) | 0.08 | 0.02 | Glenair Test |
| Wire | Tefzel® | Tefzel® | 0.22 | 0.01 | NASA Test #GSC19998 |

- 3.3.4 **Thermal shock.** Unmated connectors shall withstand 5 cycles of thermal shock with a minimum temperature of -65° C. and a maximum temperature of 150° C. when tested in accordance with EIA-364-32, Condition IV. Connectors shall not exhibit any detrimental damage or degradation of electrical performance.
- 3.3.5 **Humidity**
- 3.3.5.1 **Humidity, MWDM connectors with interfacial seals.** Wired, mated connectors shall be subjected to humidity conditioning in accordance with EIA-364-31, Test Condition IV. After a minimum of 3 hours of step 7a of the final cycle, and while the connectors are still subjected to high humidity, the insulation resistance shall be measured when the chamber temperature reaches 20° ± 5° C. Insulation resistance shall not be less than 100 megohms, and connectors shall pass a DWV test of 360 volts (rms 60 hertz ac).
- 3.3.5.2 **Humidity, MWDL plastic connectors without interfacial seals.** Wired, mated connectors shall be subjected to humidity conditioning in accordance with EIA-364-31, Test Condition IV. On completion of step 6 of the final cycle, connectors shall be removed from the chamber, unmated and surface moisture removed. Connectors shall meet 1 megohm minimum and shall pass a DWV test of 100 volts (rms 60 hertz ac).
- 3.3.6 **Vibration (sine).** Connectors, when mated, wired in series and fixtured in accordance with MIL-DTL-83513F, shall not exhibit any discontinuity longer than 1 microsecond when tested in accordance with EIA-364-28 Test Condition IV, which specifies 12 hour duration, 10 Hz to 2000 Hz, and amplitude of 20 g_n peak. Connectors shall not be damaged and no loosening of parts shall occur.
- 3.3.7 **Shock.** Connectors, when mated, wired in series and fixtured in accordance with MIL-DTL-83513F, shall not exhibit any discontinuity longer than 1 microsecond when tested in accordance with EIA-364-27, Test Condition E, which specifies an amplitude of 50 g peak. Connectors shall not be damaged and no loosening of parts shall occur.
- 3.3.8 **Marking Permanency.** Connector marking shall meet the requirements of MIL-STD-202 Method 215.
- 3.3.9 **Fungus resistance.** Connector materials shall meet the requirements of MIL-STD-810 Method 508.5.



Micro-D Metal Shell Weights In Grams¹

| Layout | Solder Cup | Pigtail2 | PCB "CBR" | PCB "BR" | PCB "BS" | PCB "CBS" |
|--------|------------|----------|-----------|----------|----------|-----------|
| 9P | 1.7 | 1.6 | 3.9 | 5.9 | 4.1 | 3.1 |
| 9S | 1.7 | 1.6 | 3.9 | 5.9 | 4.1 | 3.1 |
| 15P | 2.3 | 2.2 | 4.8 | 6.8 | 4.7 | 3.3 |
| 15S | 2.2 | 2.1 | 4.7 | 6.7 | 4.7 | 3.4 |
| 21P | 3.0 | 2.9 | 5.6 | 7.7 | 5.7 | 4.1 |
| 21S | 2.6 | 2.5 | 5.4 | 7.6 | 5.6 | 4.8 |
| 25P | 3.3 | 3.2 | 6.1 | 8.3 | 5.9 | 5.3 |
| 25S | 3.0 | 2.9 | 6.0 | 8.2 | 6.1 | 5.5 |
| 31P | 3.9 | 3.8 | 7.6 | 9.5 | 7.2 | 6.5 |
| 31S | 3.6 | 3.5 | 7.5 | 9.4 | 7.3 | 6.6 |
| 37P | 4.4 | 4.2 | 8.4 | 11.1 | 8.5 | 7.7 |
| 37S | 4.1 | 3.9 | 8.4 | 11.0 | 8.3 | 7.5 |
| 51P | 5.1 | 4.9 | 11.0 | 12.7 | 9.6 | 8.6 |
| 51S | 4.8 | 4.7 | 10.9 | 12.8 | 9.5 | 8.6 |
| 51-2P | 5.0 | 4.8 | 10.9 | 12.5 | 9.5 | 8.5 |
| 51-2S | 4.7 | 4.4 | 10.8 | 12.4 | 9.4 | 8.5 |
| 67P | 5.7 | 5.5 | 13.4 | 13.6 | 10.6 | 9.5 |
| 67S | 5.4 | 5.3 | 13.2 | 13.4 | 10.5 | 9.4 |
| 69P | 6.2 | 6.0 | 14.0 | 14.1 | 11.1 | 10.0 |
| 69S | 5.9 | 5.8 | 13.5 | 13.9 | 11.0 | 9.9 |
| 75P | 7.4 | 7.1 | 17.3 | 19.5 | 14.7 | 12.6 |
| 75S | 7.1 | 6.9 | 17.1 | 19.3 | 14.6 | 12.5 |
| 100P | 9.1 | 8.6 | 26.6 | 27.5 | 25.4 | 22.9 |
| 100S | 8.2 | 7.9 | 26.4 | 27.1 | 24.8 | 22.3 |
| 130P | 13.0 | 12.4 | 34.2 | 37.0 | 32.6 | 29.4 |
| 130S | 11.8 | 11.4 | 33.9 | 36.5 | 32.1 | 28.9 |

1. Nominal weight shown. Add 10% for maximum weight. 2. Weight is connector only. See table below for wire weight calculation.

Stainless Steel Micro-D Weight Adders

| Layout | Stainless Steel Adder in Grams |
|--------|--------------------------------|
| 9P | 1.9 |
| 9S | 2.0 |
| 15P | 2.4 |
| 15S | 2.4 |
| 21P | 2.9 |
| 21S | 2.8 |
| 25P | 3.2 |
| 25S | 2.9 |
| 31P | 3.4 |
| 31S | 3.2 |
| 37P | 3.6 |
| 37S | 4.1 |
| 51P | 4.0 |
| 51S | 3.8 |
| 51-2P | 6.2 |
| 51-2S | 6.0 |
| 67P | 7.1 |
| 67S | 6.8 |
| 69P | 7.3 |
| 69S | 7.0 |
| 75P | 7.7 |
| 75S | 7.4 |
| 100P | 8.3 |
| 100S | 8.0 |
| 130P | 11.8 |
| 130S | 11.5 |

How To Calculate Weights for Different Wire Types and Lengths

| Wire Type | Wire Gage (AWG) | Maximum Wire Weight Per Inch in Grams |
|-----------|-----------------|---------------------------------------|
| M22759/11 | 24 | .098 |
| M22759/11 | 26 | .072 |
| M22759/11 | 28 | .052 |
| M22759/33 | 24 | .076 |
| M22759/33 | 26 | .053 |
| M22759/33 | 28 | .034 |
| M22759/33 | 30 | .025 |

EXAMPLE CALCULATION:

MWDM2L-37P-6K7-54B (54 inches of M22759/11 #26 gage wire)

1. Find the connector weight in the "Pigtail" column above 4.2 g.
2. Find the wire weight in grams per inch 0.072 g./in.
3. Multiply the # of conductors times length and weight
37 wires x 54 inches x .072 g./in. = 144 g.
4. Add the connector weight to the wire weight..... 148.2 g.

1. Nominal weight shown. Add 10% for maximum weight.
2. Weight includes 18 inches of M22759/11-26 insulated #26 AWG copper wire.

Face View Pin Connector – Micro-D Contact Arrangements



9 pin



15 pin



21 pin



25 pin



31 pin



37 pin



51 pin



51 pin (special 2 row)



67 pin



69 pin



75 pin



100 pin



130 pin

Micro-D Contact Arrangements



Face View Socket Connector – Micro-D Contact Arrangements



9 socket



15 socket



21 socket



25 socket



31 socket



37 socket



51 socket



51 socket (special 2 row)



67 socket



69 socket



75 socket



100 socket



130 socket



Micro-D Panel Cutouts

A

Recommended Micro-D Panel Cutouts



Front Panel Mounting



Rear Panel Mounting

Plastic Shell MWDL Connectors (M83513/06 Thru /09)

| Layout | A | | B | | C | | D | | E | | F | |
|--------|----------------|---------------|----------------|---------------|----------------|---------------|----------------|---------------|--------------------------|-------------------------|----------------|---------------|
| | In . ± .003 | mm. ± 0.08 | In . ± .002 | mm. ± 0.05 | In . ± .002 | mm. ± 0.05 | In . ± .002 | mm. ± 0.05 | In . + .005 - .000 | mm. + 0.13 - 0.00 | In . ± .002 | mm. ± 0.05 |
| 9 | .565 | 14.35 | .410 | 10.41 | .091 | 2.31 | .174 | 4.42 | .219 | 5.56 | .126 | 3.20 |
| 15 | .715 | 18.16 | .560 | 14.22 | .091 | 2.31 | .174 | 4.42 | .219 | 5.56 | .126 | 3.20 |
| 21 | .865 | 21.97 | .710 | 18.03 | .091 | 2.31 | .174 | 4.42 | .219 | 5.56 | .126 | 3.20 |
| 25 | .965 | 24.51 | .810 | 20.57 | .091 | 2.31 | .174 | 4.42 | .219 | 5.56 | .126 | 3.20 |
| 31 | 1.115 | 28.32 | .960 | 24.38 | .091 | 2.31 | .174 | 4.42 | .219 | 5.56 | .126 | 3.20 |
| 37 | 1.265 | 32.13 | 1.110 | 28.19 | .091 | 2.31 | .174 | 4.42 | .219 | 5.56 | .126 | 3.20 |
| 51 | 1.215 | 30.86 | 1.060 | 26.92 | .091 | 2.31 | .217 | 5.51 | .261 | 5.56 | .126 | 3.20 |

Metal Shell MWDM Connectors

| Layout | A | | B | | C | | D | | E | | F | |
|--------|----------------|---------------|----------------|---------------|----------------|---------------|----------------|---------------|----------------|---------------|----------------|---------------|
| | In . ± .003 | mm. ± 0.08 | In . ± .002 | mm. ± 0.05 | In . ± .002 | mm. ± 0.05 | In . ± .002 | mm. ± 0.05 | In . ± .005 | mm. ± 0.13 | In . ± .002 | mm. ± 0.05 |
| 9 | .565 | 14.35 | .410 | 10.41 | .091 | 2.31 | .277 | 7.04 | .256 | 6.50 | .126 | 3.20 |
| 15 | .715 | 18.16 | .560 | 14.22 | .091 | 2.31 | .277 | 7.04 | .256 | 6.50 | .126 | 3.20 |
| 21 | .865 | 21.97 | .710 | 18.03 | .091 | 2.31 | .277 | 7.04 | .256 | 6.50 | .126 | 3.20 |
| 25 | .965 | 24.51 | .810 | 20.57 | .091 | 2.31 | .277 | 7.04 | .256 | 6.50 | .126 | 3.20 |
| 31 | 1.115 | 28.32 | .960 | 24.38 | .091 | 2.31 | .277 | 7.04 | .256 | 6.50 | .126 | 3.20 |
| 37 | 1.265 | 32.13 | 1.110 | 28.19 | .091 | 2.31 | .277 | 7.04 | .256 | 6.50 | .126 | 3.20 |
| 51 | 1.215 | 30.86 | 1.060 | 26.92 | .091 | 2.31 | .317 | 8.05 | .300 | 7.62 | .126 | 3.20 |
| 51-2 | 1.615 | 41.02 | 1.460 | 37.08 | .091 | 2.31 | .277 | 7.04 | .256 | 6.50 | .126 | 3.20 |
| 67 | 2.015 | 51.18 | 1.858 | 47.19 | .091 | 2.31 | .277 | 7.04 | .256 | 6.50 | .126 | 3.20 |
| 69 | 1.515 | 38.48 | 1.360 | 34.54 | .091 | 2.31 | .317 | 8.05 | .300 | 7.62 | .126 | 3.20 |
| 75 | 1.705 | 43.31 | 1.460 | 37.08 | .120 | 3.05 | .317 | 8.05 | .300 | 7.62 | .147 | 3.79 |
| 100 | 1.800 | 45.72 | 1.455 | 36.96 | .120 | 3.05 | .363 | 9.22 | .338 | 10.31 | .147 | 3.73 |
| 130 | 2.150 | 54.61 | 1.799 | 45.69 | .120 | 3.05 | .363 | 9.22 | .338 | 10.31 | .147 | 3.73 |

Recommended Mating Dimension



Metric dimensions
(mm) are indicated in
parentheses.

MIL-STD-681 Color Code Chart



MIL-STD-681 Color Code Chart for Micro-D Connectors

| PIN NO. | MIL-STD-681 NO NUMBER | Base Color | First Stripe | Second Stripe | PIN NO. | MIL-STD-681 NUMBER. | Base Color | First Stripe | Second Stripe | Third Stripe |
|---------|-----------------------|------------|--------------|---------------|---------|---------------------|------------|--------------|---------------|--------------|
| 1 | 0 | BLK | | | 51 | 957 | WHT | GRN | VIO | |
| 2 | 1 | BRN | | | 52 | 958 | WHT | GRN | GRY | |
| 3 | 2 | RED | | | 53 | 967 | WHT | BLU | VIO | |
| 4 | 3 | ORN | | | 54 | 968 | WHT | BLU | GRY | |
| 5 | 4 | YEL | | | 55 | 978 | WHT | VIO | GRY | |
| 6 | 5 | GRN | | | 56 | 9012 | WHT | BLK | BRN | RED |
| 7 | 6 | BLU | | | 57 | 9013 | WHT | BLK | BRN | ORN |
| 8 | 7 | VIO | | | 58 | 9014 | WHT | BLK | BRN | YEL |
| 9 | 8 | GRY | | | 59 | 9015 | WHT | BLK | BRN | GRN |
| 10 | 9 | WHT | | | 60 | 9016 | WHT | BLK | BRN | BLU |
| 11 | 90 | WHT | BLK | | 61 | 9017 | WHT | BLK | BRN | VIO |
| 12 | 91 | WHT | BRN | | 62 | 9018 | WHT | BLK | BRN | GRY |
| 13 | 92 | WHT | RED | | 63 | 9023 | WHT | BLK | RED | ORN |
| 14 | 93 | WHT | ORN | | 64 | 9024 | WHT | BLK | RED | YEL |
| 15 | 94 | WHT | YEL | | 65 | 9025 | WHT | BLK | RED | GRN |
| 16 | 95 | WHT | GRN | | 66 | 9026 | WHT | BLK | RED | BLU |
| 17 | 96 | WHT | BLU | | 67 | 9027 | WHT | BLK | RED | VIO |
| 18 | 97 | WHT | VIO | | 68 | 9028 | WHT | BLK | RED | GRY |
| 19 | 98 | WHT | GRY | | 69 | 9034 | WHT | BLK | ORN | YEL |
| 20 | 901 | WHT | BLK | BRN | 70 | 9035 | WHT | BLK | ORN | GRN |
| 21 | 902 | WHT | BLK | RED | 71 | 9036 | WHT | BLK | ORN | BLU |
| 22 | 903 | WHT | BLK | ORN | 72 | 9037 | WHT | BLK | ORN | VIO |
| 23 | 904 | WHT | BLK | YEL | 73 | 9038 | WHT | BLK | ORN | GRY |
| 24 | 905 | WHT | BLK | GRN | 74 | 9045 | WHT | BLK | YEL | GRN |
| 25 | 906 | WHT | BLK | BLU | 75 | 9046 | WHT | BLK | YEL | BLU |
| 26 | 907 | WHT | BLK | VIO | 76 | 9047 | WHT | BLK | YEL | VIO |
| 27 | 908 | WHT | BLK | GRY | 77 | 9048 | WHT | BLK | YEL | GRY |
| 28 | 912 | WHT | BRN | RED | 78 | 9056 | WHT | BLK | GRN | BLU |
| 29 | 913 | WHT | BRN | ORN | 79 | 9057 | WHT | BLK | GRN | VIO |
| 30 | 914 | WHT | BRN | YEL | 80 | 9058 | WHT | BLK | GRN | GRY |
| 31 | 915 | WHT | BRN | GRN | 81 | 9067 | WHT | BLK | BLU | VIO |
| 32 | 916 | WHT | BRN | BLU | 82 | 9068 | WHT | BLK | BLU | GRY |
| 33 | 917 | WHT | BRN | VIO | 83 | 9078 | WHT | BLK | VIO | GRY |
| 34 | 918 | WHT | BRN | GRY | 84 | 9123 | WHT | BRN | RED | ORN |
| 35 | 923 | WHT | RED | ORN | 85 | 9124 | WHT | BRN | RED | YEL |
| 36 | 924 | WHT | RED | YEL | 86 | 9125 | WHT | BRN | RED | GRN |
| 37 | 925 | WHT | RED | GRN | 87 | 9126 | WHT | BRN | RED | BLU |
| 38 | 926 | WHT | RED | BLU | 88 | 9127 | WHT | BRN | RED | VIO |
| 39 | 927 | WHT | RED | VIO | 89 | 9128 | WHT | BRN | RED | GRY |
| 40 | 928 | WHT | RED | GRY | 90 | 9134 | WHT | BRN | ORN | YEL |
| 41 | 934 | WHT | ORN | YEL | 91 | 9135 | WHT | BRN | ORN | GRN |
| 42 | 935 | WHT | ORN | GRN | 92 | 9136 | WHT | BRN | ORN | BLU |
| 43 | 936 | WHT | ORN | BLU | 93 | 9137 | WHT | BRN | ORN | VIO |
| 44 | 937 | WHT | ORN | VIO | 94 | 9138 | WHT | BRN | ORN | GRY |
| 45 | 938 | WHT | ORN | GRY | 95 | 9145 | WHT | BRN | YEL | GRN |
| 46 | 945 | WHT | YEL | GRN | 96 | 9146 | WHT | BRN | YEL | BLU |
| 47 | 946 | WHT | YEL | BLU | 97 | 9147 | WHT | BRN | YEL | VIO |
| 48 | 947 | WHT | YEL | VIO | 98 | 9148 | WHT | BRN | YEL | GRY |
| 49 | 948 | WHT | YEL | GRY | 99 | 9156 | WHT | BRN | GRN | BLU |
| 50 | 956 | WHT | GRN | BLU | 100 | 9157 | WHT | BRN | GRN | VIO |



Reference Data

A

Table 3: Standard Wire Specifications

| Wire Code | Specification | Insulation | Conductor | Operating Temp. | Voltage Rating | AWG | Strands | Max. Conductor Diameter (Inches) | DC Resistance Ohms/1000 Ft. | Max. Finished Wire Dia. |
|-----------|---------------|-------------------------------------|--|-----------------|----------------|-----|---------|----------------------------------|-----------------------------|-------------------------|
| E | NEMA HP3-EXB | Extruded PTFE | Silver-coated copper | -65° to +200°C | 600 volts RMS | #24 | 7/32 | .025 | 24.5 | .048 |
| | | | | | | #26 | 7/34 | .020 | 39.7 | .043 |
| | | | | | | #28 | 7/36 | .016 | 63.6 | .039 |
| | | | | | | #30 | 7/38 | .013 | 100 | .036 |
| J | M22759/33 | Extruded cross-linked modified ETFE | Silver-coated high-strength copper alloy | -65° to +200°C | 600 volts RMS | #24 | 19/36 | .025 | 28.4 | .037 |
| | | | | | | #26 | 19/38 | .020 | 44.8 | .034 |
| | | | | | | #28 | 7/36 | .016 | 74.4 | .029 |
| | | | | | | #30 | 7/38 | .012 | 117.4 | .026 |
| K | M22759/11 | Extruded PTFE | Silver-coated copper | -65° to +200°C | 600 volts RMS | #24 | 19/36 | .025 | 24.3 | .045 |
| | | | | | | #26 | 19/38 | .020 | 38.4 | .040 |
| | | | | | | #28 | 7/36 | .015 | 63.8 | .035 |

Table 4: Stocked Wire Sizes and Colors

| Wire Code | Color Code | Wire Insulation Color | #24 AWG | #26 AWG | #28AWG | #30 AWG |
|-----------|------------|--------------------------------------|---------|---------|---------------|---------------|
| E | 1 | White | ✓ | ✓ | ✓ | ✓ |
| | 2 | Yellow | ✓ | ✓ | ✓ | ✓ |
| | 5 | White with MIL-STD-681 color stripes | ⚠ | ⚠ | not available | not available |
| | 7 | 10 Color Repeat | ✓ | ✓ | ✓ | ✓ |
| J | 1 | White | ✓ | ✓ | ✓ | ✓ |
| | 2 | Yellow | ✓ | ✓ | ✓ | ✓ |
| | 5 | White with MIL-STD-681 color stripes | ⚠ | ⚠ | not available | not available |
| | 7 | 10 Color Repeat | ✓ | ✓ | ✓ | ✓ |
| K | 1 | White | ✓ | ✓ | ✓ | not available |
| | 2 | Yellow | ✓ | ✓ | ✓ | not available |
| | 5 | White with MIL-STD-681 color stripes | ⚠ | ⚠ | not available | not available |
| | 7 | 10 Color Repeat | ✓ | ✓ | ✓ | not available |

= Stocked wire.

= Stocked wire through 51 colors only. Connectors with more than 51 contacts are not available with striped wire. 10 color repeating is the recommended alternate.

TwistPin Connectors and RoHS Compliance



European Union Directive 2002/95/EC on Restriction of the use of certain Hazardous Substances ("RoHS") states that certain types of equipment (primarily consumer electronic products such as personal computers) shall not contain lead, mercury, cadmium, hexavalent chromium, PBB's or PBDE's. For the record, Glenair does not produce any OEM products of this type. Furthermore, our interconnect components are either free of the substances RoHS controls, or specifically intended for use in military-aerospace applications that are exempt. Makers of consumer products should refer to the following guidelines to insure Glenair interconnect components are correctly specified when used in in RoHS regulated electronic equipment.

Are Micro-D Connectors RoHS compliant?
 The products in this catalog can be ordered with various plating finishes. Some of these finishes such as cadmium and chem film, along with solder-dipping, do not comply with the RoHS directive.

Why doesn't Glenair eliminate non-RoHS products?
 Glenair products are typically used in defense and aerospace equipment exempt from RoHS requirements. Glenair will continue to offer cadmium and chromate finishes in accordance with DoD and aerospace specifications. Our part numbers contain a broad range of plating finish ordering codes. Customers can easily specify RoHS compliant finishes if desired.

Products that do not comply with RoHS regulations:

- 1 Cadmium plating** is available on metal shell connectors in this catalog. Note that cadmium plating does not currently comply with RoHS rules.
- 2 Chem film** is available on metal shell connectors. This coating contains hexavalent chromium which does not currently comply with RoHS rules.
- 3 Tin-lead solder dipped printed circuit board tails.** Board mount M83513 Micro-D's and other products are normally solder dipped in 63% tin 37% lead molton solder. RoHS compliance for consumer products requires elimination of solder coatings containing lead.

RoHS compliance made easy

- 1 Specify electroless nickel plating on the connector shell.**
 Or, choose stainless steel shells for maximum corrosion protection and RoHS compliance.
- 2 Use Mod Code 513 on Micro-D board mount connectors.**
 Board mount Micro-D's and other products are normally solder dipped in 63% tin 37% lead molton solder. Any solder-dipped part can be supplied with RoHS compliant gold-plating instead simply by adding Mod Code 513 as a suffix to the standard part number.

| Micro-D ROHS Compliance Examples | | | |
|----------------------------------|---|--|----------------------------|
| Part Number | Problem | Solution | RoHS Compliant Part Number |
| MWDM1L-37PSB | Plating code 1 specifies cadmium plating. | Change to electroless nickel plating (code 2). | MWDM2L-37PSB |
| MWDM2L-25SCBRP-.110 | CBR style PCB connectors are solder-dipped in tin-lead. | Add Mod Code 513 to change the PC tail finish to gold plating. | MWDM2L-25SCBRP-.110-513 |
| MWDM6L-9S-6K7-18L | Plating code 6 specifies chem film. | Change to electroless nickel plating (code 2). | MWDM2L-9S-6K7-18L |
| M83513/03-E07C | Cadmium plated shell and solder-dipped contacts. | Change to nickel plating and gold contacts | M83513/03-E05N |



RoHS Compliance Information

A

Micro-D Connector Plating Codes: ROHS Compliance

| Micro-D Plating Code | Plating Type | RoHS Compliance | Notes |
|----------------------|---|---|---|
| 1, A | Cadmium with yellow chromate conversion coating over electroless nickel | No | Electroless nickel is the preferred alternate. |
| 2, B | Electroless nickel |  | First choice for RoHS compliance. Good corrosion resistance, excellent conductivity, M83513 approved, always in stock. |
| 3, F | Stainless steel shell, passivated |  | Higher cost but unsurpassed corrosion resistance, not conductive enough for typical EMI needs. Build-to-order. |
| 4, D | Black anodize over aluminum |  | Economical, non-reflective, non-conductive. Build-to-order. |
| 5, E | Gold over aluminum |  | Low volume, higher cost, excellent conductivity. Build-to-order. |
| 6, C | Chem film | No | Electroless nickel is the preferred alternate. |
| 33, T | Nickel-PTFE |  | Glenair's 500 Hour Grey™ meets the need for a cadmium replacement with excellent conductivity, wear resistance and corrosion protection, M83513 approved. |

Micro-D Backshell Plating Codes: ROHS Compliance

| Plating Code | Plating Type | RoHS Compliance | Notes |
|--------------|---|---|--|
| J | Cadmium with yellow chromate conversion coating over electroless nickel | No | Electroless nickel is the preferred alternate. |
| M | Electroless nickel |  | First choice for RoHS compliance. Good corrosion resistance, excellent conductivity, M83513 approved, always in stock. |
| C | Black anodize |  | Inexpensive, non-reflective, not suitable for EMI (poor conductivity), build-to-order. |
| Z2 | Gold |  | Low volume, higher cost, excellent conductivity, build-to-order. |
| E | Chem film | No | Electroless nickel is the preferred alternate. |
| MT | Nickel-PTFE |  | Glenair's 1000 Hour Grey™ meets the need for a cadmium replacement with excellent conductivity, wear resistance and corrosion protection, M83513 approved. |
| NF | Cadmium with olive drab chromate conversion coating over electroless nickel | No | Electroless nickel is the preferred alternate. |

Section B Micro-D Metal Shell Connectors for Harness Application



Product Selection Guide

B

GRPM Solder Cup
Page B-2



GRPM Solder Cup Rear Panel Mount Connector

GRPM-Insulated Wire
Page B-4



GRPM Insulated Wire Rear Panel Mount Connector

GRPM Uninsulated Wire
Page B-6



GRPM Uninsulated Wire Rear Panel Mount Connector

MWDM Solder Cup
Page B-8



MWDM Solder Cup Connector

MWDM Insulated Wire
Page B-10



MWDM Insulated-Wire Connector

MWDM Back-To-Back
Page B-12



MWDM Back-To-Back Unshielded Cable

MWDM Shielded Cable
Page B-14

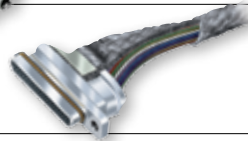

MWDM Shielded Cable Assemblies

MWDM Uninsulated Wire
Page B-19



MWDM Uninsulated Wire Connector

GMDR Insulated Wire
Page B-21



GMDR Right Angle Exit with Insulated Wire Connector

GMDE Environmental
Page B-23



GMDE Environmentally Sealed Connector

GSWM
SpaceWire Assembly
Page B-27



GSWM SpaceWire Assembly

GMLM MasterLatch™
Insulated Wire
B-29



GMLM MasterLatch™



Micro-D GRPM Solder Cup Terminated Rear Panel Mount Connectors with Wide Flange



Micro-D Solder Cup Termination – These connectors feature gold-plated TwistPin contacts for best performance. Use with #26 AWG or smaller wire. Specify nickel-plated shells or cadmium plated shells for best availability.

Now Available with #24 AWG Contact – 24 AWG wire offers increased mechanical strength and lower voltage drop. Glenair Micro-D solder cup connectors are now compatible with 24 AWG stranded or solid wire. Specify "N" for 24 AWG pin contacts or "T" for 24 AWG socket contacts

How To Order Solder Cup Rear Panel Mount Connector

| Sample Part Number | GRPM | 2 | L- | 15 | S | S | R3 | N |
|----------------------------------|---|-----------------|---|-----------------|-----------------|-----------------|-----------------|---|
| Series | GRPM Glenair Rear Panel Micro | | | | | | | |
| Shell Material and Finish | Aluminum Shell 1 - Cadmium 2 - Nickel 4 - Black Anodize 5 - Gold 6 - Chem Film | | Stainless Steel Shell 3 - Passivated | | | | | |
| Insulator Material | L - LCP or PPS LCP - 30% Glass-filled liquid crystal polymer PPS - 40% Glass-filled polyphenylene sulfide | | | | | | | |
| Contact Layout | 9, 15, 21, 25, 31, 37, 51-2, 51, 69, 75, 100, 130 (See Table I) | | | | | | | |
| Contact Type | Standard Sizes P - Pin S - Socket | | Size #24 Solder Cup N - Pin T - Socket | | | | | |
| Termination Type | S - Solder Cup | | | | | | | |
| Rear Panel Mount Hardware Option | B - No hardware | R1 - .032 panel | R2 - .047 panel | R3 - .062 panel | R4 - .093 panel | R5 - .125 panel | R6 - .080 panel | |
| O-Ring | C - Conductive | | N - Non Conductive (Nitrile) | | | | | |

Materials and Finishes

| | |
|------------------|---|
| Connector Shell | Aluminum Alloy 6061 or Stainless Steel, 300 Series, passivated. See Ordering Info for Plating Options |
| Insulator | Liquid Crystal Polymer (LCP) or Polyphenylene Sulfide (PPS) |
| Interfacial Seal | Fluorosilicone Rubber, Blue |
| Pin Contact | Beryllium Copper Gold over Nickel Plating |
| Socket Contact | Copper Alloy Gold Over Nickel Plating |
| Hardware | 300 Series Stainless Steel |
| Encapsulant | Epoxy Resin Hysol EE4215 |

Performance Specifications

| | |
|---------------------------|-------------------------------|
| Current Rating | 3 AMP |
| DWV | 600 VAC Sea level |
| Insulation Resistance | 5000 Megohms Minimum |
| Contact Resistance | 8 Milliohms Maximum |
| Low Level Contact Resist. | 32 Milliohms Maximum |
| Magnetic Permeability | 2 μ Maximum |
| Operating Temperature | -55° C. to +150° C. |
| Shock, Vibration | 50 g., 20g. |
| Mating Force | (10 Ounces) X (# of Contacts) |

Notes:

1. Assembly to be identified with Glenair's name, part number, date code, and pin 1 identification
2. Performance data per MIL-DTL-83513
3. Interface dimensions per MIL-DTL-83513

Micro-D GRPM Solder Cup Terminated Rear Panel Mount Connectors with Wide Flange



Table I: Dimensions



| Layout | A | | B | | C Max | | D | | E Max | | F | | G | | H Max | | J Max | | K Ref | | L Max | |
|--------|--------------|-------------|--------------|-------------|-------|-------|--------------|-------------|-------|------|--------------|-------------|--------------|-------------|-------|-------|-------|-------|-------|------|-------|-------|
| | in. ±.005 | mm. ±.13 | in. ±.003 | mm. ±.08 | in. | mm. | in. ±.005 | mm. ±.13 | in. | mm. | in. ±.003 | mm. ±.08 | in. ±.005 | mm. ±.13 | in. | mm. | in. | mm. | in. | mm. | in. | mm. |
| 9P | .960 | 24.38 | .565 | 14.35 | .334 | 8.48 | .480 | 12.19 | .184 | 4.67 | .183 | 4.65 | .529 | 13.44 | .790 | 20.07 | .310 | 7.87 | .210 | 5.33 | .416 | 10.57 |
| 9S | .960 | 24.38 | .565 | 14.35 | .400 | 10.16 | .480 | 12.19 | .250 | 6.35 | .195 | 4.95 | .541 | 13.74 | .790 | 20.07 | .310 | 7.87 | .210 | 5.33 | .429 | 10.90 |
| 15P | 1.110 | 28.19 | .715 | 18.16 | .484 | 12.29 | .480 | 12.19 | .184 | 4.67 | .183 | 4.65 | .529 | 13.44 | .940 | 23.88 | .310 | 7.87 | .210 | 5.33 | .416 | 10.57 |
| 15S | 1.110 | 28.19 | .715 | 18.16 | .550 | 13.97 | .480 | 12.19 | .250 | 6.35 | .195 | 4.95 | .541 | 13.74 | .940 | 23.88 | .310 | 7.87 | .210 | 5.33 | .429 | 10.90 |
| 21P | 1.260 | 32.00 | .865 | 21.97 | .634 | 16.10 | .480 | 12.19 | .184 | 4.67 | .183 | 4.65 | .529 | 13.44 | 1.090 | 27.69 | .310 | 7.87 | .210 | 5.33 | .416 | 10.57 |
| 21S | 1.260 | 32.00 | .865 | 21.97 | .700 | 17.78 | .480 | 12.19 | .250 | 6.35 | .195 | 4.95 | .541 | 13.74 | 1.090 | 27.69 | .310 | 7.87 | .210 | 5.33 | .429 | 10.90 |
| 25P | 1.360 | 34.54 | .965 | 24.51 | .734 | 18.64 | .480 | 12.19 | .184 | 4.67 | .183 | 4.65 | .529 | 13.44 | 1.190 | 30.23 | .310 | 7.87 | .210 | 5.33 | .416 | 10.57 |
| 25S | 1.360 | 34.54 | 0.965 | 24.51 | .800 | 20.32 | .480 | 12.19 | .250 | 6.35 | .195 | 4.95 | .541 | 13.74 | 1.190 | 30.23 | .310 | 7.87 | .210 | 5.33 | .429 | 10.90 |
| 31P | 1.510 | 38.35 | 1.115 | 28.32 | .884 | 22.45 | .480 | 12.19 | .184 | 4.67 | .183 | 4.65 | .529 | 13.44 | 1.340 | 34.04 | .310 | 7.87 | .210 | 5.33 | .416 | 10.57 |
| 31S | 1.510 | 38.35 | 1.115 | 28.32 | .950 | 24.13 | .480 | 12.19 | .250 | 6.35 | .195 | 4.95 | .541 | 13.74 | 1.340 | 34.04 | .310 | 7.87 | .210 | 5.33 | .429 | 10.90 |
| 37P | 1.660 | 42.16 | 1.265 | 32.13 | 1.034 | 26.26 | .480 | 12.19 | .184 | 4.67 | .183 | 4.65 | .529 | 13.44 | 1.490 | 37.85 | .310 | 7.87 | .210 | 5.33 | .416 | 10.57 |
| 37S | 1.660 | 42.16 | 1.265 | 32.13 | 1.100 | 27.94 | .480 | 12.19 | .250 | 6.35 | .195 | 4.95 | .541 | 13.74 | 1.490 | 37.85 | .310 | 7.87 | .210 | 5.33 | .429 | 10.90 |
| 51-2P | 2.010 | 51.05 | 1.615 | 41.02 | 1.384 | 35.15 | .480 | 12.19 | 0.184 | 4.67 | .183 | 4.65 | .529 | 13.44 | 1.840 | 46.74 | .310 | 7.87 | .210 | 5.33 | 0.416 | 10.57 |
| 51-2S | 2.010 | 51.05 | 1.615 | 41.02 | 1.450 | 36.83 | .480 | 12.19 | 0.250 | 6.35 | .195 | 4.95 | .541 | 13.74 | 1.840 | 46.74 | .310 | 7.87 | .210 | 5.33 | 0.429 | 10.90 |
| 51P | 1.660 | 42.16 | 1.215 | 30.86 | .984 | 24.99 | .525 | 13.34 | .224 | 5.69 | .183 | 4.65 | .529 | 13.44 | 1.440 | 36.58 | .351 | 8.92 | .210 | 5.33 | .416 | 10.57 |
| 51S | 1.660 | 42.16 | 1.215 | 30.86 | 1.050 | 26.67 | .525 | 13.34 | .293 | 7.44 | .195 | 4.95 | .541 | 13.74 | 1.440 | 36.58 | .351 | 8.92 | .210 | 5.33 | .429 | 10.90 |
| 69P | 1.960 | 49.78 | 1.515 | 38.48 | 1.284 | 32.61 | .525 | 13.34 | .224 | 5.69 | .183 | 4.65 | .529 | 13.44 | 1.740 | 44.20 | .351 | 8.92 | .210 | 5.33 | .416 | 10.57 |
| 69S | 1.960 | 49.78 | 1.515 | 38.48 | 1.350 | 34.29 | .525 | 13.34 | .293 | 7.44 | .195 | 4.95 | .541 | 13.74 | 1.740 | 44.20 | .351 | 8.92 | .210 | 5.33 | .429 | 10.90 |
| 75P | 2.150 | 54.61 | 1.705 | 43.31 | 1.384 | 35.15 | .525 | 13.34 | .224 | 5.69 | .183 | 4.65 | .529 | 13.44 | 2.085 | 52.96 | .351 | 8.92 | .280 | 7.11 | .416 | 10.57 |
| 75S | 2.150 | 54.61 | 1.705 | 43.31 | 1.450 | 36.83 | .525 | 13.34 | .293 | 7.44 | .195 | 4.95 | .541 | 13.74 | 2.085 | 52.96 | .351 | 8.92 | .280 | 7.11 | .429 | 10.90 |
| 100P | 2.385 | 60.58 | 1.800 | 45.72 | 1.384 | 35.15 | 0.600 | 15.24 | 0.270 | 6.86 | .183 | 4.65 | .529 | 13.44 | 2.230 | 56.64 | .394 | 10.01 | .300 | 7.65 | .416 | 10.57 |
| 100S | 2.385 | 60.58 | 1.800 | 45.72 | 1.451 | 36.86 | 0.600 | 15.24 | 0.333 | 8.46 | .195 | 4.95 | .541 | 13.74 | 2.230 | 56.64 | .394 | 10.01 | .300 | 7.65 | .429 | 10.90 |
| 130P | 2.735 | 69.47 | 2.150 | 54.61 | 1.735 | 44.07 | .600 | 15.24 | .270 | 6.86 | .183 | 4.65 | .529 | 13.44 | 2.425 | 61.59 | .394 | 10.01 | .340 | 8.64 | .416 | 10.57 |
| 130S | 2.735 | 69.47 | 2.150 | 54.61 | 1.795 | 45.60 | .600 | 15.24 | .333 | 8.46 | .195 | 4.95 | .541 | 13.74 | 2.425 | 61.59 | .394 | 10.01 | .340 | 8.64 | .429 | 10.90 |



Micro-D GRPM Insulated-Wire Rear Panel Mount Connector with Wide Flange



Micro-D Pre-Wired Pigtails—These connectors feature gold-plated TwistPin contacts and mil spec crimp termination. Specify nickel-plated shells or cadmium plated shells for best availability. 100% tested and backpotted, ready for use.

Choose the Wire Type and Size To Fit Your Application—If on-hand availability is most important, choose #26 AWG Type K mil spec fluoropolymer wire or M22759/33 Type J for space applications.

How To Order Insulated Wire Rear Panel Mount Connector

| Sample Part Number | GRPM | 2 | L | -15 | P | -6 | K | 7 | 18 | R3 | N |
|---|---|---|---|-----|-----------------|----|-----------------|---|----|----|---|
| Series | GRPM Glenair Rear Panel Micro | | | | | | | | | | |
| Shell Material and Finish | Aluminum Shell 1 - Cadmium 2 - Nickel 4 - Black Anodize 5 - Gold 6 - Chem Film | | Stainless Steel Shell 3 - Passivated | | | | | | | | |
| Insulator Material | L - LCP or PPS LCP - 30% Glass-Filled Liquid Crystal Polymer PPS - 40% Glass-Filled Polyphenylene Sulfide | | | | | | | | | | |
| Contact Layout | 9, 15, 21, 25, 31, 37, 51-2, 51, 69, 75, 100, 130 (See Table I) | | | | | | | | | | |
| Contact Type | P - Pin S - Socket | | | | | | | | | | |
| Wire Gage | 4 - #24 6 - #26 8 - #28 0 - #30 (ETFE) Wire Only | | | | | | | | | | |
| Stranded Wire Type | K - M22759/11 - 600 VRMS Fluoropolymer (TFE) J - M22759/33 - 600 VRMS Modified Cross-Linked Tefzel® E - NEMA HP3-EB - 600 VRMS (M16878/4) | | | | | | | | | | |
| Stranded Wire Color | 1 - White 2 - Yellow 5 - Full Color 7 - 10 Color Repeat | | | | | | | | | | |
| Stranded Wire Length | 18 - 18 inches | | | | | | | | | | |
| Rear Panel Mount Hardware Option | B - No Hardware | | R1 - .032 panel | | R2 - .047 panel | | | | | | |
| | R3 - .062 panel | | R4 - .093 panel | | R5 - .125 panel | | R6 - .080 panel | | | | |
| O-Ring | C - Conductive N - Non Conductive (Nitrile) | | | | | | | | | | |

Materials and Finishes

| | |
|------------------|---|
| Connector Shell | Aluminum Alloy 6061 or Stainless Steel, 300 Series, passivated. See Ordering Info for Plating Options |
| Insulator | Liquid Crystal Polymer (LCP) or Polyphenylene Sulfide (PPS) |
| Interfacial Seal | Fluorosilicone Rubber, Blue |
| Pin Contact | Beryllium Copper Gold over Nickel Plating |
| Socket Contact | Copper Alloy Gold Over Nickel Plating |
| Hardware | 300 Series Stainless Steel |
| Encapsulant | Epoxy Resin Hysol EE4215 |

Performance Specifications

| | |
|---------------------------|-------------------------------|
| Current Rating | 3 AMP |
| DWV | 600 VAC Sea level |
| Insulation Resistance | 5000 Megohms Minimum |
| Contact Resistance | 8 Milliohms Maximum |
| Low Level Contact Resist. | 32 Milliohms Maximum |
| Magnetic Permeability | 2 μ Maximum |
| Operating Temperature | -55° C. to +150° C. |
| Shock, Vibration | 50 g., 20g. |
| Mating Force | (10 Ounces) X (# of Contacts) |

Notes:

1. Assembly to be identified with Glenair's name, part number, date code, and pin 1 identification
2. Performance data per MIL-DTL-83513
3. Interface dimensions per MIL-DTL-83513

Micro-D GRPM Insulated-Wire Rear Panel Mount Connector with Wide Flange



Table I: Dimensions



| Layout | A | | B | | C Max | | D | | E Max | | F | | G | | H Max | | J Max | | K Ref | |
|--------|--------------|-------------|--------------|-------------|-------|-------|--------------|-------------|-------|------|--------------|-------------|--------------|-------------|-------|-------|-------|-------|-------|------|
| | in. ±.005 | mm. ±.13 | in. ±.003 | mm. ±.08 | in. | mm. | in. ±.005 | mm. ±.13 | in. | mm. | in. ±.003 | mm. ±.08 | in. ±.005 | mm. ±.13 | in. | mm. | in. | mm. | in. | mm. |
| 9P | .960 | 24.38 | .565 | 14.35 | .334 | 8.48 | .480 | 12.19 | .184 | 4.67 | .183 | 4.65 | .529 | 13.44 | .790 | 20.07 | .310 | 7.87 | .210 | 5.33 |
| 9S | .960 | 24.38 | .565 | 14.35 | .400 | 10.16 | .480 | 12.19 | .250 | 6.35 | .195 | 4.95 | .541 | 13.74 | .790 | 20.07 | .310 | 7.87 | .210 | 5.33 |
| 15P | 1.110 | 28.19 | .715 | 18.16 | .484 | 12.29 | .480 | 12.19 | .184 | 4.67 | .183 | 4.65 | .529 | 13.44 | .940 | 23.88 | .310 | 7.87 | .210 | 5.33 |
| 15S | 1.110 | 28.19 | .715 | 18.16 | .550 | 13.97 | .480 | 12.19 | .250 | 6.35 | .195 | 4.95 | .541 | 13.74 | .940 | 23.88 | .310 | 7.87 | .210 | 5.33 |
| 21P | 1.260 | 32.00 | .865 | 21.97 | .634 | 16.10 | .480 | 12.19 | .184 | 4.67 | .183 | 4.65 | .529 | 13.44 | 1.090 | 27.69 | .310 | 7.87 | .210 | 5.33 |
| 21S | 1.260 | 32.00 | .865 | 21.97 | .700 | 17.78 | .480 | 12.19 | .250 | 6.35 | .195 | 4.95 | .541 | 13.74 | 1.090 | 27.69 | .310 | 7.87 | .210 | 5.33 |
| 25P | 1.360 | 34.54 | .965 | 24.51 | .734 | 18.64 | .480 | 12.19 | .184 | 4.67 | .183 | 4.65 | .529 | 13.44 | 1.190 | 30.23 | .310 | 7.87 | .210 | 5.33 |
| 25S | 1.360 | 34.54 | .965 | 24.51 | .800 | 20.32 | .480 | 12.19 | .250 | 6.35 | .195 | 4.95 | .541 | 13.74 | 1.190 | 30.23 | .310 | 7.87 | .210 | 5.33 |
| 31P | 1.510 | 38.35 | 1.115 | 28.32 | .884 | 22.45 | .480 | 12.19 | .184 | 4.67 | .183 | 4.65 | .529 | 13.44 | 1.340 | 34.04 | .310 | 7.87 | .210 | 5.33 |
| 31S | 1.510 | 38.35 | 1.115 | 28.32 | .950 | 24.13 | .480 | 12.19 | .250 | 6.35 | .195 | 4.95 | .541 | 13.74 | 1.340 | 34.04 | .310 | 7.87 | .210 | 5.33 |
| 37P | 1.660 | 42.16 | 1.265 | 32.13 | 1.034 | 26.26 | .480 | 12.19 | .184 | 4.67 | .183 | 4.65 | .529 | 13.44 | 1.490 | 37.85 | .310 | 7.87 | .210 | 5.33 |
| 37S | 1.660 | 42.16 | 1.265 | 32.13 | 1.100 | 27.94 | .480 | 12.19 | .250 | 6.35 | .195 | 4.95 | .541 | 13.74 | 1.490 | 37.85 | .310 | 7.87 | .210 | 5.33 |
| 51-2P | 1.66 | 42.16 | 1.215 | 30.86 | .984 | 24.99 | .525 | 13.34 | .224 | 5.69 | .183 | 4.65 | .529 | 3.44 | 1.440 | 36.58 | .351 | 8.92 | .210 | 5.33 |
| 51-2S | 1.66 | 42.16 | 1.215 | 30.86 | 1.05 | 26.67 | .525 | 13.34 | .293 | 7.44 | .195 | 4.95 | .541 | 13.74 | 1.440 | 36.58 | .351 | 8.92 | .210 | 5.33 |
| 51P | 1.660 | 42.16 | 1.215 | 30.86 | .984 | 24.99 | .525 | 13.34 | .224 | 5.69 | .183 | 4.65 | .529 | 13.44 | 1.440 | 36.58 | .351 | 8.92 | .210 | 5.33 |
| 51S | 1.660 | 42.16 | 1.215 | 30.86 | 1.050 | 26.67 | .525 | 13.34 | .293 | 7.44 | .195 | 4.95 | .541 | 13.74 | 1.440 | 36.58 | .351 | 8.92 | .210 | 5.33 |
| 69P | 1.960 | 49.78 | 1.515 | 38.48 | 1.284 | 32.61 | .525 | 13.34 | .224 | 5.69 | .183 | 4.65 | .529 | 13.44 | 1.740 | 44.20 | .351 | 8.92 | .210 | 5.33 |
| 69S | 1.960 | 49.78 | 1.515 | 38.48 | 1.350 | 34.29 | .525 | 13.34 | .293 | 7.44 | .195 | 4.95 | .541 | 13.74 | 1.740 | 44.20 | .351 | 8.92 | .210 | 5.33 |
| 75P | 2.150 | 54.61 | 1.705 | 43.31 | 1.384 | 35.15 | .525 | 13.34 | .224 | 5.69 | .183 | 4.65 | .529 | 13.44 | 2.085 | 52.96 | .351 | 8.92 | .280 | 7.11 |
| 75S | 2.150 | 54.61 | 1.705 | 43.31 | 1.450 | 36.83 | .525 | 13.34 | .293 | 7.44 | .195 | 4.95 | .541 | 13.74 | 2.085 | 52.96 | .351 | 8.92 | .280 | 7.11 |
| 100P | 2.385 | 60.58 | 1.800 | 45.72 | 1.384 | 35.15 | .600 | 15.24 | .270 | 6.86 | .183 | 4.65 | .529 | 13.44 | 2.230 | 56.64 | .394 | 10.01 | .300 | 7.65 |
| 100S | 2.385 | 60.58 | 1.800 | 45.72 | 1.451 | 36.86 | .600 | 15.24 | .333 | 8.46 | .195 | 4.95 | .541 | 13.74 | 2.230 | 56.64 | .394 | 10.01 | .300 | 7.65 |
| 130P | 2.735 | 69.47 | 2.150 | 54.61 | 1.735 | 44.07 | .600 | 15.24 | .270 | 6.86 | .183 | 4.65 | .529 | 13.44 | 2.425 | 61.59 | .394 | 10.01 | .340 | 8.64 |
| 130S | 2.735 | 69.47 | 2.150 | 54.61 | 1.795 | 45.60 | .600 | 15.24 | .333 | 8.46 | .195 | 4.95 | .541 | 13.74 | 2.425 | 61.59 | .394 | 10.01 | .340 | 8.64 |



Micro-D GRPM Uninsulated Wire Rear Panel Mount Connector with Wide Flange

High Performance – These connectors meet the demanding requirements of MIL-DTL-83513.

Solder-Dipped – Terminals are coated with Sn60/Pb40 tin-lead solder for best solderability. Optional gold-plated terminals are available for RoHS compliance



How To Order Uninsulated Wire Rear Panel Mount Connector

| Sample Part Number | GRPM | 2 | L- | 15 | P- | 4 | C | 4- | .250 | R3 | N |
|----------------------------------|---|---|-----------------------|----|-----------------|---|-----------------|----|------|----|---|
| Series | GRPM Glenair Rear Panel Micro | | | | | | | | | | |
| Shell Material and Finish | Aluminum Shell | | Stainless Steel Shell | | | | | | | | |
| | 1 - Cadmium 2 - Nickel | | 3 - Passivated | | | | | | | | |
| | 4 - Black Anodize | | | | | | | | | | |
| | 5 - Gold 6 - Chem Film | | | | | | | | | | |
| Insulator Material | L - LCP or PPS LCP - 30% Glass-Filled Liquid Crystal Polymer PPS - 40% Glass-Filled Polyphenylene Sulfide | | | | | | | | | | |
| Contact Layout | 9, 15, 21, 25, 31, 37, 51-2, 51, 69, 75, 100, 130 (See Table I) | | | | | | | | | | |
| Contact Type | P - Pin S - Socket | | | | | | | | | | |
| Wire Gage | 4 - #24 (.020) 5 - #25 (.018) 6 - #26(.016) | | | | | | | | | | |
| Wire Type | C - Solid Copper | | | | | | | | | | |
| Termination Finish | 3 - Solder Dipped 4 - Gold | | | | | | | | | | |
| Wire Length | .125, .250, .375, .500, .750, 1.000 | | | | | | | | | | |
| Rear Panel Mount Hardware Option | B - No hardware | | R1 - .032 panel | | R2 - .047 panel | | | | | | |
| | R3 - .062 panel | | R4 - .093 panel | | R5 - .125 panel | | R6 - .080 panel | | | | |
| O-Ring | C - Conductive N - Non Conductive (Nitrile) | | | | | | | | | | |

Materials and Finishes

| | |
|------------------|---|
| Connector Shell | Aluminum Alloy 6061 or Stainless Steel, 300 Series, passivated. See Ordering Info for Plating Options |
| Insulator | Liquid Crystal Polymer (LCP) or Polyphenylene Sulfide (PPS) |
| Interfacial Seal | Fluorosilicone Rubber, Blue |
| Pin Contact | Beryllium Copper Gold over Nickel Plating |
| Socket Contact | Copper Alloy Gold Over Nickel Plating |
| Hardware | 300 Series Stainless Steel |
| Encapsulant | Epoxy Resin Hysol EE4215 |

Performance Specifications

| | |
|---------------------------|-------------------------------|
| Current Rating | 3 AMP |
| DWV | 600 VAC Sea level |
| Insulation Resistance | 5000 Megohms Minimum |
| Contact Resistance | 8 Milliohms Maximum |
| Low Level Contact Resist. | 32 Milliohms Maximum |
| Magnetic Permeability | 2 μ Maximum |
| Operating Temperature | -55° C. to +150° C. |
| Shock, Vibration | 50 g., 20g. |
| Mating Force | (10 Ounces) X (# of Contacts) |

Notes:

1. Assembly to be identified with Glenair's name, part number, date code, and pin 1 identification
2. Performance data per MIL-DTL-83513
3. Interface dimensions per MIL-DTL-83513

Micro-D GRPM Uninsulated Wire Rear Panel Mount Connector with Wide Flange



Table I: Dimensions



| Layout | A | | B | | C Max | | D | | E Max | | F | | G | | H Max | | J Max | | K Ref | |
|--------|--------------|-------------|--------------|-------------|-------|-------|--------------|-------------|-------|------|--------------|-------------|--------------|-------------|-------|-------|-------|-------|-------|------|
| | in. ±.005 | mm. ±.13 | in. ±.003 | mm. ±.08 | in. | mm. | in. ±.005 | mm. ±.13 | in. | mm. | in. ±.003 | mm. ±.08 | in. ±.005 | mm. ±.13 | in. | mm. | in. | mm. | in. | mm. |
| 9P | .960 | 24.38 | 0.565 | 14.35 | .334 | 8.48 | .480 | 12.19 | .184 | 4.67 | .183 | 4.65 | .529 | 13.44 | .790 | 20.07 | .310 | 7.87 | .210 | 5.33 |
| 9S | 0.960 | 24.38 | 0.565 | 14.35 | .400 | 10.16 | .480 | 12.19 | .250 | 6.35 | .195 | 4.95 | .541 | 13.74 | .790 | 20.07 | .310 | 7.87 | .210 | 5.33 |
| 15P | 1.110 | 28.19 | 0.715 | 18.16 | .484 | 12.29 | .480 | 12.19 | .184 | 4.67 | .183 | 4.65 | .529 | 13.44 | .940 | 23.88 | .310 | 7.87 | .210 | 5.33 |
| 15S | 1.110 | 28.19 | 0.715 | 18.16 | .550 | 13.97 | .480 | 12.19 | .250 | 6.35 | .195 | 4.95 | .541 | 13.74 | .940 | 23.88 | .310 | 7.87 | .210 | 5.33 |
| 21P | 1.260 | 32.00 | 0.865 | 21.97 | .634 | 16.10 | .480 | 12.19 | .184 | 4.67 | .183 | 4.65 | .529 | 13.44 | 1.090 | 27.69 | .310 | 7.87 | .210 | 5.33 |
| 21S | 1.260 | 32.00 | 0.865 | 21.97 | .700 | 17.78 | .480 | 12.19 | .250 | 6.35 | .195 | 4.95 | .541 | 13.74 | 1.090 | 27.69 | .310 | 7.87 | .210 | 5.33 |
| 25P | 1.360 | 34.54 | 0.965 | 24.51 | .734 | 18.64 | .480 | 12.19 | .184 | 4.67 | .183 | 4.65 | .529 | 13.44 | 1.190 | 30.23 | .310 | 7.87 | .210 | 5.33 |
| 25S | 1.360 | 34.54 | 0.965 | 24.51 | .800 | 20.32 | .480 | 12.19 | .250 | 6.35 | .195 | 4.95 | .541 | 13.74 | 1.190 | 30.23 | .310 | 7.87 | .210 | 5.33 |
| 31P | 1.510 | 38.35 | 1.115 | 28.32 | .884 | 22.45 | .480 | 12.19 | .184 | 4.67 | .183 | 4.65 | .529 | 13.44 | 1.340 | 34.04 | .310 | 7.87 | .210 | 5.33 |
| 31S | 1.510 | 38.35 | 1.115 | 28.32 | .950 | 24.13 | .480 | 12.19 | .250 | 6.35 | .195 | 4.95 | .541 | 13.74 | 1.340 | 34.04 | .310 | 7.87 | .210 | 5.33 |
| 37P | 1.660 | 42.16 | 1.265 | 32.13 | 1.034 | 26.26 | .480 | 12.19 | .184 | 4.67 | .183 | 4.65 | .529 | 13.44 | 1.490 | 37.85 | .310 | 7.87 | .210 | 5.33 |
| 37S | 1.660 | 42.16 | 1.265 | 32.13 | 1.100 | 27.94 | .480 | 12.19 | .250 | 6.35 | .195 | 4.95 | .541 | 13.74 | 1.490 | 37.85 | .310 | 7.87 | .210 | 5.33 |
| 51-2P | 2.010 | 51.05 | 1.615 | 41.02 | 1.384 | 35.15 | .480 | 12.19 | .184 | 4.67 | .183 | 4.65 | .529 | 13.44 | 1.840 | 46.74 | .310 | 7.87 | .210 | 5.33 |
| 51-2S | 2.010 | 51.05 | 1.615 | 41.02 | 1.450 | 36.83 | .480 | 12.19 | .250 | 6.35 | .195 | 4.95 | .541 | 13.74 | 1.840 | 46.74 | .310 | 7.87 | .210 | 5.33 |
| 51P | 1.660 | 42.16 | 1.215 | 30.86 | 0.984 | 24.99 | .525 | 13.34 | .224 | 5.69 | .183 | 4.65 | .529 | 13.44 | 1.440 | 36.58 | .351 | 8.92 | .210 | 5.33 |
| 51S | 1.660 | 42.16 | 1.215 | 30.86 | 1.050 | 26.67 | .525 | 13.34 | .293 | 7.44 | .195 | 4.95 | .541 | 13.74 | 1.440 | 36.58 | .351 | 8.92 | .210 | 5.33 |
| 69P | 1.960 | 49.78 | 1.515 | 38.48 | 1.284 | 32.61 | .525 | 13.34 | .224 | 5.69 | .183 | 4.65 | .529 | 13.44 | 1.740 | 44.20 | .351 | 8.92 | .210 | 5.33 |
| 69S | 1.960 | 49.78 | 1.515 | 38.48 | 1.350 | 34.29 | .525 | 13.34 | .293 | 7.44 | .195 | 4.95 | .541 | 13.74 | 1.740 | 44.20 | .351 | 8.92 | .210 | 5.33 |
| 75P | 2.150 | 54.61 | 1.705 | 43.31 | 1.384 | 35.15 | .525 | 13.34 | .224 | 5.69 | .183 | 4.65 | .529 | 13.44 | 2.085 | 52.96 | .351 | 8.92 | .280 | 7.11 |
| 75S | 2.150 | 54.61 | 1.705 | 43.31 | 1.450 | 36.83 | .525 | 13.34 | .293 | 7.44 | .195 | 4.95 | .541 | 13.74 | 2.085 | 52.96 | .351 | 8.92 | .280 | 7.11 |
| 100P | 2.385 | 60.58 | 1.800 | 45.72 | 1.384 | 35.15 | .600 | 15.24 | .270 | 6.86 | .183 | 4.65 | .529 | 13.44 | 2.230 | 56.64 | .394 | 10.01 | .300 | 7.65 |
| 100S | 2.385 | 60.58 | 1.800 | 45.72 | 1.451 | 36.86 | .600 | 15.24 | .333 | 8.46 | .195 | 4.95 | .541 | 13.74 | 2.230 | 56.64 | .394 | 10.01 | .300 | 7.65 |
| 130P | 2.735 | 69.47 | 2.150 | 54.61 | 1.735 | 44.07 | .600 | 15.24 | .270 | 6.86 | .183 | 4.65 | .529 | 13.44 | 2.425 | 61.59 | .394 | 10.01 | .340 | 8.64 |
| 130S | 2.735 | 69.47 | 2.150 | 54.61 | 1.795 | 45.60 | .600 | 15.24 | .333 | 8.46 | .195 | 4.95 | .541 | 13.74 | 2.425 | 61.59 | .394 | 10.01 | .340 | 8.64 |



Micro-D MWDM Solder Cup Metal Shell Connectors



Micro-D Solder Cup Termination—These connectors feature gold-plated TwistPin contacts for best performance. Use with #26 AWG or smaller wire. Specify nickel-plated shells or cadmium plated shells for best availability.

Now Available with #24 AWG Contacts—AWG 24 wire offers increased mechanical strength and lower voltage drop. Glenair Micro-D solder cup connectors are now compatible with 24 AWG stranded or solid wire. Specify “N” for 24 AWG pin contacts, or “T” for 24 AWG socket contacts.

How To Order Solder Cup Connectors

| Sample Part Number | MWDM | 2 | L- | 37 | S | S | B |
|---------------------------|---|---|----|---|---|---|---|
| Series | MWDM Glenair Micro-D | | | | | | |
| Shell Material and Finish | Aluminum Shell 1 - Cadmium 2 - Nickel 4 - Black Anodize 5 - Gold 6 - Chem Film | | | Stainless Steel Shell 3 - Passivated | | | |
| Insulator Material | L - LCP or PPS LCP - 30% Glass-Filled Liquid Crystal Polymer PPS - 40% Glass Filled Polyphenylene Sulfide | | | | | | |
| Contact Layout | 9, 15, 21, 25, 31, 37, 51, 51-2, 67, 69, 75, 100, 130 (See Table II) | | | | | | |
| Contact Type | Size #26 Solder Cup Contacts (Standard) P - Pin S - Socket | | | Size #24 Solder Cup Contacts N - Pin T - Socket | | | |
| Termination Type | S - Solder Cup | | | | | | |
| Hardware | B, P, M, M1, S, S1, L, K, F, R, H (See Table I) | | | | | | |

Table I: Mounting Hardware

| B | P | M | M1 | S | S1 | L | K | F | R | H |
|-----------|----------|--------------------|------------------------------|---------------------|-------------------------------|----------------------------------|--|--------------------------------------|-------------------------------------|-----------------|
| | | | | | | | | | | |
| Thru-Hole | Jackpost | Hex Head Jackscrew | Hex Head Jackscrew, Extended | Slot Head Jackscrew | Slot Head Jackscrew, Extended | Hex Head Jackscrew Non-Removable | Slot Head Jackscrew Non-Removable Extended | Float Mount For Front Panel Mounting | Float Mount For Rear Panel Mounting | Threaded Insert |

Micro-D MWDM Solder Cup Metal Shell Connectors



Table II: Dimensions



B

| Layout | A Max. | | B | | C Max. | | D Max. | | E Max. | | F | | G Max. | | H Max. | | J Max. | |
|--------|--------|-------|---------------|---------------|--------|-------|--------|------|--------|-------|---------------|---------------|--------|-------|--------|-------|--------|------|
| | In. | mm. | In. ± .003 | mm. ± 0.08 | In. | mm. | In. | mm. | In. | mm. | In. ± .003 | mm. ± 0.08 | In. | mm. | In. | mm. | In. | mm. |
| 9P | .785 | 19.94 | .565 | 14.35 | .333 | 8.46 | .184 | 4.67 | .308 | 7.82 | .183 | 4.65 | .416 | 10.57 | .400 | 10.16 | .270 | 6.86 |
| 9S | .785 | 19.94 | .565 | 14.35 | .400 | 10.16 | .250 | 6.35 | .308 | 7.82 | .195 | 4.95 | .429 | 10.90 | .400 | 10.16 | .270 | 6.86 |
| 15P | .935 | 23.75 | .715 | 18.16 | .483 | 12.27 | .184 | 4.67 | .308 | 7.82 | .183 | 4.65 | .416 | 10.57 | .550 | 13.97 | .270 | 6.86 |
| 15S | .935 | 23.75 | .715 | 18.16 | .551 | 14.00 | .250 | 6.35 | .308 | 7.82 | .195 | 4.95 | .429 | 10.90 | .550 | 13.97 | .270 | 6.86 |
| 21P | 1.085 | 27.56 | .865 | 21.97 | .633 | 16.08 | .184 | 4.67 | .308 | 7.82 | .183 | 4.65 | .416 | 10.57 | .700 | 17.78 | .270 | 6.86 |
| 21S | 1.085 | 27.56 | .865 | 21.97 | .701 | 17.81 | .250 | 6.35 | .308 | 7.82 | .195 | 4.95 | .429 | 10.90 | .700 | 17.78 | .270 | 6.86 |
| 25P | 1.185 | 30.01 | .965 | 24.51 | .733 | 18.62 | .184 | 4.67 | .308 | 7.82 | .183 | 4.65 | .416 | 10.57 | .800 | 20.32 | .270 | 6.86 |
| 25S | 1.185 | 30.01 | .965 | 24.51 | .801 | 20.35 | .250 | 6.35 | .308 | 7.82 | .195 | 4.95 | .429 | 10.90 | .800 | 20.32 | .270 | 6.86 |
| 31P | 1.335 | 33.91 | 1.115 | 28.32 | .883 | 22.43 | .184 | 4.67 | .308 | 7.82 | .183 | 4.65 | .416 | 10.57 | .950 | 24.13 | .270 | 6.86 |
| 31S | 1.335 | 33.91 | 1.115 | 28.32 | .951 | 24.16 | .250 | 6.35 | .308 | 7.82 | .195 | 4.95 | .429 | 10.90 | .950 | 24.13 | .270 | 6.86 |
| 37P | 1.485 | 37.72 | 1.265 | 32.13 | 1.033 | 26.24 | .184 | 4.67 | .308 | 7.82 | .183 | 4.65 | .416 | 10.57 | 1.100 | 27.94 | .270 | 6.86 |
| 37S | 1.485 | 37.72 | 1.265 | 32.13 | 1.101 | 27.96 | .250 | 6.35 | .308 | 7.82 | .195 | 4.95 | .429 | 10.90 | 1.100 | 27.94 | .270 | 6.86 |
| 51P | 1.435 | 36.45 | 1.215 | 30.86 | .983 | 24.97 | .228 | 5.79 | .351 | 8.92 | .183 | 4.65 | .416 | 10.57 | 1.050 | 26.67 | .310 | 7.87 |
| 51S | 1.435 | 36.45 | 1.215 | 30.86 | 1.051 | 26.70 | .296 | 7.52 | .351 | 8.92 | .195 | 4.95 | .429 | 10.90 | 1.050 | 26.67 | .310 | 7.87 |
| 51-2P | 1.835 | 46.61 | 1.615 | 41.02 | 1.384 | 35.15 | .184 | 4.67 | .310 | 7.87 | .183 | 4.65 | .416 | 10.57 | 1.450 | 36.83 | .270 | 6.86 |
| 51-2S | 1.835 | 46.61 | 1.615 | 41.02 | 1.450 | 36.83 | .250 | 6.35 | .310 | 7.87 | .195 | 4.95 | .429 | 10.90 | 1.450 | 36.83 | .270 | 6.86 |
| 67P | 2.235 | 56.77 | 2.015 | 51.18 | 1.784 | 45.31 | .184 | 4.67 | .310 | 7.87 | .183 | 4.65 | .416 | 10.57 | 1.850 | 36.83 | .270 | 6.86 |
| 67S | 2.235 | 56.77 | 2.015 | 51.18 | 1.850 | 46.99 | .250 | 6.35 | .310 | 7.87 | .195 | 4.95 | .429 | 10.90 | 1.850 | 36.83 | .270 | 6.86 |
| 69P | 1.735 | 44.07 | 1.515 | 38.48 | 1.284 | 32.61 | .228 | 5.79 | .351 | 8.92 | .183 | 4.65 | .416 | 10.57 | 1.350 | 34.29 | .310 | 7.87 |
| 69S | 1.735 | 44.07 | 1.515 | 38.48 | 1.350 | 34.29 | .296 | 7.52 | .351 | 8.92 | .195 | 4.95 | .429 | 10.90 | 1.350 | 34.29 | .310 | 7.87 |
| 75P | 2.080 | 52.8 | 1.705 | 43.3 | 1.384 | 35.2 | .228 | 5.79 | .351 | 8.91 | .183 | 4.6 | .416 | 10.57 | 1.440 | 36.58 | .310 | 7.87 |
| 75S | 2.080 | 52.8 | 1.705 | 43.3 | 1.450 | 36.8 | .296 | 7.52 | .351 | 8.91 | .195 | 5.0 | .429 | 10.90 | 1.440 | 36.58 | .310 | 7.87 |
| 100P | 2.170 | 55.12 | 1.800 | 45.72 | 1.383 | 35.13 | .270 | 6.86 | .394 | 10.01 | .183 | 4.65 | .416 | 10.57 | 1.442 | 36.63 | .360 | 9.14 |
| 100S | 2.170 | 55.12 | 1.800 | 45.72 | 1.451 | 36.86 | .333 | 8.46 | .394 | 10.01 | .195 | 4.95 | .429 | 10.90 | 1.442 | 36.63 | .360 | 9.14 |
| 130P | 2.520 | 64.00 | 2.160 | 54.86 | 1.735 | 44.07 | .270 | 6.86 | .394 | 10.01 | .183 | 4.65 | .416 | 10.57 | 1.780 | 45.21 | .360 | 9.14 |
| 130S | 2.520 | 64.00 | 2.160 | 54.86 | 1.795 | 45.60 | .333 | 8.46 | .394 | 10.01 | .195 | 4.95 | .429 | 10.90 | 1.780 | 45.21 | .360 | 9.14 |

| Performance Specifications | |
|----------------------------|-------------------------------|
| Current Rating | 3 AMP |
| DWV | 600 VAC Sea level |
| Insulation Resistance | 5000 Megohms Minimum |
| Contact Resistance | 8 Milliohms Maximum |
| Low Level Contact Resist. | 32 Milliohms Maximum |
| Magnetic Permeability | 2 μ Maximum |
| Operating Temperature | -55° C. to +150° C. |
| Shock, Vibration | 50 g., 20g. |
| Mating Force | (10 Ounces) X (# of Contacts) |

| Materials and Finishes | |
|------------------------|---|
| Connector Shell | Aluminum Alloy 6061 or Stainless Steel, 300 Series, passivated. See Ordering Info for Plating Options |
| Insulator | Liquid Crystal Polymer (LCP)/ Polyphenylene Sulfide(PPS) |
| Interfacial Seal | Fluorosilicone Rubber, Blue |
| Pin Contact | Beryllium Copper Gold over Nickel Plating |
| Socket Contact | Copper Alloy Gold Over Nickel Plating |
| Hardware | 300 Series Stainless Steel |
| Encapsulant | Epoxy Resin Hysol EE4215 |



Micro-D MWDM Insulated Wire Metal Shell Connectors



Micro-D Insulated Wire Pigtails—These connectors feature gold-plated TwistPin contacts and mil spec crimp termination. Specify nickel-plated shells or cadmium plated shells for best availability. 100% tested and backpotted, ready for use.

Choose the Wire Type and Size To Fit Your Application—If on-hand availability is most important, choose #26 AWG Type K mil spec Teflon® wire. Select M22759/33 Type J for space applications.

How To Order Insulated Wire Connector

| Sample Part Number | MWDM | 2 | L- | 25 | S- | 4 | K | 7- | 18 | B |
|---------------------------|---|---|--|----|----|---|---|----|----|---|
| Series | MWDM Glenair Micro-D | | | | | | | | | |
| Shell Material and Finish | Aluminum Shell 1 - Cadmium 2 - Nickel 4 - Black Anodize 5 - Gold 6 - Chem Film | | Stainless Steel Shell 3 - Passivated | | | | | | | |
| Insulator Material | L - LCP or PPS LCP - 30% Glass-Filled Liquid Crystal Polymer PPS - 40% Glass filled polyphenylene sulfide | | | | | | | | | |
| Contact Layout | 9, 15, 21, 25, 31, 37, 51, 51-2, 67, 69, 75, 100, 130 (See Table II) | | | | | | | | | |
| Contact Type | P - Pin S - Socket | | | | | | | | | |
| Wire Gage (AWG) | 4 - #24 6 - #26 8 - #28 0 - #30 (J wire type only) | | | | | | | | | |
| Wire Type | K - M22759/11 600 VRMS Teflon® (TFE) | | J - M22759/33 600 VRMS Modified Cross- Linked Tefzel® (ETFE) | | | E - NEMA HP3-EB 600 VRMS Type E M16878/4 (TFE) | | | | |
| Wire Color | 1 - White 2 - Yellow 5 - Color-Coded Stripes Per MIL-STD-681 (up to 51 colors) 7 - Ten Color Repeating | | | | | | | | | |
| Wire Length Inches | 18 - Wire Length In Inches. "18" Specifies 18 Inches. | | | | | | | | | |
| Hardware | B, P, M, M1, S, S1, L, K, F, R, H (See Table I) | | | | | | | | | |

Table I: Mounting Hardware

| B | P | M | M1 | S | S1 | L | K | F | R | H |
|-----------|----------|--------------------|------------------------------|---------------------|-------------------------------|----------------------------------|--|--------------------------------------|-------------------------------------|-----------------|
| | | | | | | | | | | |
| Thru-Hole | Jackpost | Hex Head Jackscrew | Hex Head Jackscrew, Extended | Slot Head Jackscrew | Slot Head Jackscrew, Extended | Hex Head Jackscrew Non-Removable | Slot Head Jackscrew Non-Removable Extended | Float Mount For Front Panel Mounting | Float Mount For Rear Panel Mounting | Threaded Insert |

Micro-D MWDM Insulated Wire Metal Shell Connectors



Table II: Dimensions



| Layout | A Max. | | B | | C Max. | | D Max. | | E Max. | | F | | G Max. | | H Max. | | J Max. | |
|--------|--------|-------|---------------|---------------|--------|-------|--------|------|--------|-------|---------------|---------------|--------|-------|--------|-------|--------|------|
| | In. | mm. | In. ± .003 | mm. ± 0.08 | In. | mm. | In. | mm. | In. | mm. | In. ± .003 | mm. ± 0.08 | In. | mm. | In. | mm. | In. | mm. |
| 9P | .785 | 19.94 | .565 | 14.35 | .333 | 8.46 | .184 | 4.67 | .308 | 7.82 | .183 | 4.65 | .416 | 10.57 | .400 | 10.16 | .270 | 6.86 |
| 9S | .785 | 19.94 | .565 | 14.35 | .400 | 10.16 | .250 | 6.35 | .308 | 7.82 | .195 | 4.95 | .429 | 10.90 | .400 | 10.16 | .270 | 6.86 |
| 15P | .935 | 23.75 | .715 | 18.16 | .483 | 12.27 | .184 | 4.67 | .308 | 7.82 | .183 | 4.65 | .416 | 10.57 | .550 | 13.97 | .270 | 6.86 |
| 15S | .935 | 23.75 | .715 | 18.16 | .551 | 14.00 | .250 | 6.35 | .308 | 7.82 | .195 | 4.95 | .429 | 10.90 | .550 | 13.97 | .270 | 6.86 |
| 21P | 1.085 | 27.56 | .865 | 21.97 | .633 | 16.08 | .184 | 4.67 | .308 | 7.82 | .183 | 4.65 | .416 | 10.57 | .700 | 17.78 | .270 | 6.86 |
| 21S | 1.085 | 27.56 | .865 | 21.97 | .701 | 17.81 | .250 | 6.35 | .308 | 7.82 | .195 | 4.95 | .429 | 10.90 | .700 | 17.78 | .270 | 6.86 |
| 25P | 1.185 | 30.01 | .965 | 24.51 | .733 | 18.62 | .184 | 4.67 | .308 | 7.82 | .183 | 4.65 | .416 | 10.57 | .800 | 20.32 | .270 | 6.86 |
| 25S | 1.185 | 30.01 | .965 | 24.51 | .801 | 20.35 | .250 | 6.35 | .308 | 7.82 | .195 | 4.95 | .429 | 10.90 | .800 | 20.32 | .270 | 6.86 |
| 31P | 1.335 | 33.91 | 1.115 | 28.32 | .883 | 22.43 | .184 | 4.67 | .308 | 7.82 | .183 | 4.65 | .416 | 10.57 | .950 | 24.13 | .270 | 6.86 |
| 31S | 1.335 | 33.91 | 1.115 | 28.32 | .951 | 24.16 | .250 | 6.35 | .308 | 7.82 | .195 | 4.95 | .429 | 10.90 | .950 | 24.13 | .270 | 6.86 |
| 37P | 1.485 | 37.72 | 1.265 | 32.13 | 1.033 | 26.24 | .184 | 4.67 | .308 | 7.82 | .183 | 4.65 | .416 | 10.57 | 1.100 | 27.94 | .270 | 6.86 |
| 37S | 1.485 | 37.72 | 1.265 | 32.13 | 1.101 | 27.96 | .250 | 6.35 | .308 | 7.82 | .195 | 4.95 | .429 | 10.90 | 1.100 | 27.94 | .270 | 6.86 |
| 51P | 1.435 | 36.45 | 1.215 | 30.86 | .983 | 24.97 | .228 | 5.79 | .351 | 8.92 | .183 | 4.65 | .416 | 10.57 | 1.050 | 26.67 | .310 | 7.87 |
| 51S | 1.435 | 36.45 | 1.215 | 30.86 | 1.051 | 26.70 | .296 | 7.52 | .351 | 8.92 | .195 | 4.95 | .429 | 10.90 | 1.050 | 26.67 | .310 | 7.87 |
| 51-2P | 1.835 | 46.61 | 1.615 | 41.02 | 1.384 | 35.15 | .184 | 4.67 | .310 | 7.87 | .183 | 4.65 | .416 | 10.57 | 1.450 | 36.83 | .270 | 6.86 |
| 51-2S | 1.835 | 46.61 | 1.615 | 41.02 | 1.450 | 36.83 | .250 | 6.35 | .310 | 7.87 | .195 | 4.95 | .429 | 10.90 | 1.450 | 36.83 | .270 | 6.86 |
| 67P | 2.235 | 56.77 | 2.015 | 51.18 | 1.784 | 45.31 | .184 | 4.67 | .310 | 7.87 | .183 | 4.65 | .416 | 10.57 | 1.850 | 36.83 | .270 | 6.86 |
| 67S | 2.235 | 56.77 | 2.015 | 51.18 | 1.850 | 46.99 | .250 | 6.35 | .310 | 7.87 | .195 | 4.95 | .429 | 10.90 | 1.850 | 36.83 | .270 | 6.86 |
| 69P | 1.735 | 44.07 | 1.515 | 38.48 | 1.284 | 32.61 | .228 | 5.79 | .351 | 8.92 | .183 | 4.65 | .416 | 10.57 | 1.350 | 34.29 | .310 | 7.87 |
| 69S | 1.735 | 44.07 | 1.515 | 38.48 | 1.350 | 34.29 | .296 | 7.52 | .351 | 8.92 | .195 | 4.95 | .429 | 10.90 | 1.350 | 34.29 | .310 | 7.87 |
| 75P | 2.080 | 52.8 | 1.705 | 43.3 | 1.384 | 35.2 | .228 | 5.79 | 0.351 | 8.92 | .183 | 4.65 | .416 | 10.6 | 1.440 | 36.6 | .310 | 7.87 |
| 75S | 2.080 | 52.8 | 1.705 | 43.3 | 1.450 | 36.8 | .296 | 7.52 | 0.351 | 8.92 | .195 | 4.95 | .429 | 10.9 | 1.440 | 36.6 | .310 | 7.87 |
| 100P | 2.170 | 55.12 | 1.800 | 45.72 | 1.383 | 35.13 | .270 | 6.86 | .394 | 10.01 | .183 | 4.65 | .416 | 10.57 | 1.442 | 36.63 | .360 | 9.14 |
| 100S | 2.170 | 55.12 | 1.800 | 45.72 | 1.451 | 36.86 | .333 | 8.46 | .394 | 10.01 | .195 | 4.95 | .429 | 10.90 | 1.442 | 36.63 | .360 | 9.14 |
| 130P | 2.520 | 64.00 | 2.150 | 54.61 | 1.735 | 44.07 | .270 | 6.86 | .394 | 10.01 | .183 | 4.65 | .416 | 10.57 | 1.780 | 45.21 | .360 | 9.14 |
| 130S | 2.520 | 64.00 | 2.150 | 54.61 | 1.795 | 45.60 | .333 | 8.46 | .394 | 10.01 | .195 | 4.95 | .429 | 10.90 | 1.780 | 45.21 | .360 | 9.14 |

| Performance Specifications | |
|----------------------------|-------------------------------|
| Current Rating | 3 AMP |
| DWV | 600 VAC Sea level |
| Insulation Resistance | 5000 Megohms Minimum |
| Contact Resistance | 8 Milliohms Maximum |
| Low Level Contact Resist. | 32 Milliohms Maximum |
| Magnetic Permeability | 2 μ Maximum |
| Operating Temperature | -55° C. to +150° C. |
| Shock, Vibration | 50 g., 20g. |
| Mating Force | (10 Ounces) X (# of Contacts) |

| Materials and Finishes | |
|------------------------|---|
| Connector Shell | Aluminum Alloy 6061 or Stainless Steel, 300 Series, passivated. See Ordering Info for Plating Options |
| Insulator | Liquid Crystal Polymer (LCP)/ Polyphenyl Sulfide(PPS) |
| Interfacial Seal | Fluorosilicone Rubber, Blue |
| Pin Contact | Beryllium Copper Gold over Nickel Plating |
| Socket Contact | Copper Alloy Gold Over Nickel Plating |
| Hardware | 300 Series Stainless Steel |
| Encapsulant | Epoxy Resin Hysol EE4215 |



Micro-D MWDM Back-To-Back Metal Shell Unshielded Cable Assembly

B



Save Time and Money With Back-To-Back Cables— these Micro-D connectors feature crimp wire terminations and epoxy encapsulation. The installed cost is lower than terminating solder cup connectors.

100% Certified— All back-to-back assemblies are 100% checked for continuity, resistance, voltage and insulation resistance.

Hardware Note— If jackposts are required on one end and jackscrews on the other, use hardware designator "B" (no Hardware installed), and order hardware kits separately.

How To Order Back-to-Back Cable Assembly

| Sample Part Number | MWDM | 2 | L- | 25 | GS- | 4 | K | 7- | 18 | B |
|---------------------------|---|---|--|----|-----|---|---|----|----|---|
| Series | MWDM Glenair Micro-D | | | | | | | | | |
| Shell Material and Finish | Aluminum Shell 1 - Cadmium 2 - Nickel 4 - Black Anodize 5 - Gold 6 - Chem Film | | Stainless Steel Shell 3 - Passivated | | | | | | | |
| Insulator Material | L - LCP or PPS LCP - 30% Glass-Filled Liquid Crystal Polymer PPS - 40% Glass Filled Polyphenylene Sulfide | | | | | | | | | |
| Contact Layout | 9, 15, 21, 25, 31, 37, 51, 51-2, 67, 69, 75, 100, 130 | | | | | | | | | |
| Connector Type | GP - Pin (Plug) Connector Both Ends GS - Socket (Receptacle) Connector Both Ends CS - Pin Connector to Socket Connector | | | | | | | | | |
| Wire Gage (AWG) | 4 - #24 6 - #26 8 - #28 0 - #30 (J wire type only) | | | | | | | | | |
| Wire Type | K - M22759/11 600 VRMS Fluoropolymer (TFE) | | J - M22759/33 600 VRMS Modified Cross- Linked Tefzel® (ETFE) | | | E - NEMA HP3-EB 600 VRMS Type E M16878/4 (TFE) | | | | |
| Wire Color | 1 - White 2 - Yellow 5 - Color-Coded Stripes Per MIL-STD-681 (up to 51 colors) 7 - Ten Color Repeating | | | | | | | | | |
| Wire Length Inches | 18 - Wire Length In Inches. "18" Specifies 18 Inches. (2" Min. for 2 row, 3" Min. for 3 row, 4" Min. for 4 row) | | | | | | | | | |
| Hardware | B, P, M, M1, S, S1, L, K, F, R, H | | | | | | | | | |

Table I: Mounting Hardware

| B | P | M | M1 | S | S1 | L | K | F | R | H |
|-----------|----------|--------------------|------------------------------|---------------------|-------------------------------|----------------------------------|--|--------------------------------------|-------------------------------------|-----------------|
| | | | | | | | | | | |
| Thru-Hole | Jackpost | Hex Head Jackscrew | Hex Head Jackscrew, Extended | Slot Head Jackscrew | Slot Head Jackscrew, Extended | Hex Head Jackscrew Non-Removable | Slot Head Jackscrew Non-Removable Extended | Float Mount For Front Panel Mounting | Float Mount For Rear Panel Mounting | Threaded Insert |

Micro-D MWDM Back-To-Back Metal Shell Unshielded Cable Assembly



Table II: Dimensions



B

| Layout | A Max. | | B | | C Max. | | D Max. | | E Max. | | F | | G Max. | | H Max. | | J Max. | |
|--------|--------|-------|--------------|--------------|--------|-------|--------|------|--------|-------|--------------|--------------|--------|-------|--------|-------|--------|------|
| | In. | mm. | In. ±.003 | mm. ±0.08 | In. | mm. | In. | mm. | In. | mm. | In. ±.003 | mm. ±0.08 | In. | mm. | In. | mm. | In. | mm. |
| 9P | .785 | 19.94 | .565 | 14.35 | .333 | 8.46 | .184 | 4.67 | .308 | 7.82 | .183 | 4.65 | .416 | 10.57 | .400 | 10.16 | .270 | 6.86 |
| 9S | .785 | 19.94 | .565 | 14.35 | .400 | 10.16 | .250 | 6.35 | .308 | 7.82 | .195 | 4.95 | .429 | 10.90 | .400 | 10.16 | .270 | 6.86 |
| 15P | .935 | 23.75 | .715 | 18.16 | .483 | 12.27 | .184 | 4.67 | .308 | 7.82 | .183 | 4.65 | .416 | 10.57 | .550 | 13.97 | .270 | 6.86 |
| 15S | .935 | 23.75 | .715 | 18.16 | .551 | 14.00 | .250 | 6.35 | .308 | 7.82 | .195 | 4.95 | .429 | 10.90 | .550 | 13.97 | .270 | 6.86 |
| 21P | 1.085 | 27.56 | .865 | 21.97 | .633 | 16.08 | .184 | 4.67 | .308 | 7.82 | .183 | 4.65 | .416 | 10.57 | .700 | 17.78 | .270 | 6.86 |
| 21S | 1.085 | 27.56 | .865 | 21.97 | .701 | 17.81 | .250 | 6.35 | .308 | 7.82 | .195 | 4.95 | .429 | 10.90 | .700 | 17.78 | .270 | 6.86 |
| 25P | 1.185 | 30.01 | .965 | 24.51 | .733 | 18.62 | .184 | 4.67 | .308 | 7.82 | .183 | 4.65 | .416 | 10.57 | .800 | 20.32 | .270 | 6.86 |
| 25S | 1.185 | 30.01 | .965 | 24.51 | .801 | 20.35 | .250 | 6.35 | .308 | 7.82 | .195 | 4.95 | .429 | 10.90 | .800 | 20.32 | .270 | 6.86 |
| 31P | 1.335 | 33.91 | 1.115 | 28.32 | .883 | 22.43 | .184 | 4.67 | .308 | 7.82 | .183 | 4.65 | .416 | 10.57 | .950 | 24.13 | .270 | 6.86 |
| 31S | 1.335 | 33.91 | 1.115 | 28.32 | .951 | 24.16 | .250 | 6.35 | .308 | 7.82 | .195 | 4.95 | .429 | 10.90 | .950 | 24.13 | .270 | 6.86 |
| 37P | 1.485 | 37.72 | 1.265 | 32.13 | 1.033 | 26.24 | .184 | 4.67 | .308 | 7.82 | .183 | 4.65 | .416 | 10.57 | 1.100 | 27.94 | .270 | 6.86 |
| 37S | 1.485 | 37.72 | 1.265 | 32.13 | 1.101 | 27.96 | .250 | 6.35 | .308 | 7.82 | .195 | 4.95 | .429 | 10.90 | 1.100 | 27.94 | .270 | 6.86 |
| 51P | 1.435 | 36.45 | 1.215 | 30.86 | .983 | 24.97 | .228 | 5.79 | .351 | 8.92 | .183 | 4.65 | .416 | 10.57 | 1.050 | 26.67 | .310 | 7.87 |
| 51S | 1.435 | 36.45 | 1.215 | 30.86 | 1.051 | 26.70 | .296 | 7.52 | .351 | 8.92 | .195 | 4.95 | .429 | 10.90 | 1.050 | 26.67 | .310 | 7.87 |
| 51-2P | 1.835 | 46.61 | 1.615 | 41.02 | 1.384 | 35.15 | .184 | 4.67 | .310 | 7.87 | .183 | 4.65 | .416 | 10.57 | 1.450 | 36.83 | .270 | 6.86 |
| 51-2S | 1.835 | 46.61 | 1.615 | 41.02 | 1.450 | 36.83 | .250 | 6.35 | .310 | 7.87 | .195 | 4.95 | .429 | 10.90 | 1.450 | 36.83 | .270 | 6.86 |
| 67P | 2.235 | 56.77 | 2.015 | 51.18 | 1.784 | 45.31 | .184 | 4.67 | .310 | 7.87 | .183 | 4.65 | .416 | 10.57 | 1.850 | 36.83 | .270 | 6.86 |
| 67S | 2.235 | 56.77 | 2.015 | 51.18 | 1.850 | 46.99 | .250 | 6.35 | .310 | 7.87 | .195 | 4.95 | .429 | 10.90 | 1.850 | 36.83 | .270 | 6.86 |
| 69P | 1.735 | 44.07 | 1.515 | 38.48 | 1.284 | 32.61 | .228 | 5.79 | .351 | 8.92 | .183 | 4.65 | .416 | 10.57 | 1.350 | 34.29 | .310 | 7.87 |
| 69S | 1.735 | 44.07 | 1.515 | 38.48 | 1.350 | 34.29 | .296 | 7.52 | .351 | 8.92 | .195 | 4.95 | .429 | 10.90 | 1.350 | 34.29 | .310 | 7.87 |
| 75P | 2.080 | 52.8 | 1.705 | 43.3 | 1.384 | 35.2 | .228 | 5.8 | .351 | 8.9 | .183 | 4.65 | .416 | 10.6 | 1.440 | 36.6 | .310 | 7.87 |
| 75S | 2.080 | 52.8 | 1.705 | 43.3 | 1.450 | 36.8 | .296 | 7.5 | .351 | 8.9 | .195 | 4.95 | .429 | 10.9 | 1.440 | 36.6 | .310 | 7.87 |
| 100P | 2.170 | 55.12 | 1.800 | 45.72 | 1.383 | 35.13 | .270 | 6.86 | .394 | 10.01 | .183 | 4.65 | .416 | 10.57 | 1.442 | 36.63 | .360 | 9.14 |
| 100S | 2.170 | 55.12 | 1.800 | 45.72 | 1.451 | 36.86 | .333 | 8.46 | .394 | 10.01 | .195 | 4.95 | .429 | 10.90 | 1.442 | 36.63 | .360 | 9.14 |
| 130P | 2.520 | 64.00 | 2.160 | 54.86 | 1.735 | 44.07 | .270 | 6.86 | .394 | 10.01 | .183 | 4.65 | .416 | 10.57 | 1.780 | 45.21 | .360 | 9.14 |
| 130S | 2.520 | 64.00 | 2.160 | 54.86 | 1.795 | 45.60 | .333 | 8.46 | .394 | 10.01 | .195 | 4.95 | .429 | 10.90 | 1.780 | 45.21 | .360 | 9.14 |

| Performance Specifications | |
|----------------------------|-------------------------------|
| Current Rating | 3 AMP |
| DWV | 600 VAC Sea level |
| Insulation Resistance | 5000 Megohms Minimum |
| Contact Resistance | 8 Milliohms Maximum |
| Low Level Contact Resist. | 32 Milliohms Maximum |
| Magnetic Permeability | 2 μ Maximum |
| Operating Temperature | -55° C. to +150° C. |
| Shock, Vibration | 50 g., 20g. |
| Mating Force | (10 Ounces) X (# of Contacts) |

| Materials and Finishes | |
|------------------------|---|
| Connector Shell | Aluminum Alloy 6061 or Stainless Steel, 300 Series, passivated. See Ordering Info for Plating Options |
| Insulator | Liquid Crystal Polymer (LCP)/ Polyphenyl Sulfide(PPS) |
| Interfacial Seal | Fluorosilicone Rubber, Blue |
| Pin Contact | Beryllium Copper Gold over Nickel Plating |
| Socket Contact | Copper Alloy Gold Over Nickel Plating |
| Hardware | 300 Series Stainless Steel |
| Encapsulant | Epoxy Resin Hysol EE4215 |



MWDM Micro-D Shielded Cable Assembly



Single-Ended or Double-Ended—These easy-to-order cable assemblies eliminate the need for expensive assembly labor. 100% tested and ready for use.

Now With Twisted Pairs—No need to create a procurement specification for Micro-D cables with twisted pairs. Glenair 177-740 cables are furnished with a full complement of white/blue twisted pair wires.

Integral Shield Termination—The connector shell has a platform to accept Band-It shield termination bands. The cable shield braid is attached directly to the connector.

Save Labor, Reduce Weight and Improve EMI Shielding with Glenair's Micro-D Shielded Cable Assemblies

Aerospace electronics systems require higher and higher levels of protection from radiated emissions. Glenair's fully shielded Micro-D cable assemblies meet this need. The cable shield is attached directly onto the one-piece connector shell and secured with a stainless steel Band-Master™ ATS clamp. These pre-wired, 100% tested assemblies meet the requirements of MIL-DTL-83513. An optional ground spring on the pin connector assures low shell-to-shell resistance. Available with a variety of wire types and shields, Micro-D shielded assemblies can be ordered in any length, either single-ended or "back-to-back".

Ground Spring and EMI Shielding Effectiveness

A gold-plated stainless steel ground spring on the pin connector mating face offers substantial improvement in EMI protection. The graphs compare identical connectors tested with and without ground springs.



EMI Performance with Ground Spring



EMI Performance without Ground Spring



MWDM Micro-D Shielded Cable Assembly

177-710 (Untwisted Wire) and 177-740 (Twisted Wire Pairs)



How To Order Shielded Micro-D Cable Assemblies

| | |
|----------------------------------|---|
| Sample Part Number | 177-710 -2 -25 P 4 K 1 -18 M A G |
| Series | 177-710 - Untwisted Wire 177-740 - Twisted Pair Wire |
| Shell Material and Finish | Aluminum Shell 1 - Cadmium 2 - Electroless Nickel 5 - Gold |
| Contact Layout | 9, 15, 21, 25, 31, 37, 51, 51-2, 67, 69, 75, 100, 130 |
| Contact Type | P - Pin (Single End Plug) S - Socket (Single End Receptacle) GP - Double End Cable, Pin Connectors Both Ends GS - Double End Cable, Socket connectors Both Ends CS - Double End Cable, Pin and Socket |
| Wire Gage (AWG) | 4 - #24 6 - #26 8 - #28 0 - #30 (J wire type only) |
| Wire Type | K - Fluoropolymer Wire Per MIL-W-22759/11 (Not available in #30 gage) J - Cross-Linked Tefzel® Wire Per MIL-W-22759/33 |
| Wire Color | 1 - White (177-710 only) or White/Blue Twisted Pairs (177-740 Only) 5 - Color-Coded Per MIL-STD-681 (177-710 only)(#24 and #26 gage only) White/Blue Twisted Pairs (177-740 only) 7 - Ten Color Repeating (177-710 only) |
| Overall Length (In.) | Example "18" = 18 inches 6 Inch (152 mm.) Minimum |
| Mounting Hardware | B - No Mounting Hardware Installed F - Float Mount, for Front Panel L - Male Jackscrew, Allen Head, Non-Removable M - Male Jackscrew, Allen Head, Low Profile Mounting P - Female Jackpost R - Float Mount, for Rear Panel Mounting S - Male Jackscrew, Slot Head, Low Profile |
| Shield and Jacket Option | N - No Shield, No Jacket A - Braided Shield Installed (Nickel over Copper) C - Braided Shield Installed (Nickel over Copper) With E-CTFE Halar "Expando" Jacket (+150° C.) D - No Shield, With E-CTFE Halar "Expando" Jacket Installed (+150° C.) S - 100% Braided AmberStrand® Shield Installed T - 100% Braided AmberStrand® Shield Installed with E-CTFE Halar "Expando" Jacket (+150° C.) V - 75% Braided AmberStrand® Shield Installed Z - 75% Braided AmberStrand® Shield Installed with E-CTFE Halar "Expando" Jacket (+150° C.) W - ArmorLite™ Braided Microfilament Stainless Steel Shield Installed X - ArmorLite™ Braided Microfilament Stainless Steel Shield Installed with E-CTFE Halar "Expando" Jacket (+150° C) |
| Ground Spring Option* | N - No Ground Spring G - Ground Spring Installed (Pin Connectors Only) |

*Ground spring cannot be used with cadmium plating

Table I: Mounting Hardware

| B | P | M | S | L | F | R |
|------------------------------------|-----------------|--------------------|---------------------|----------------------------------|--------------------------------------|-------------------------------------|
| | | | | | | |
| Through-Hole, No Mounting Hardware | Female Jackpost | Hex Head Jackscrew | Slot Head Jackscrew | Hex Head Jackscrew Non-Removable | Float Mount for Front Panel Mounting | Float Mount for Rear Panel Mounting |



MWDM Micro-D Shielded Cable Assembly

177-710 (Untwisted Wire) and 177-740 (Twisted Wire Pairs)

B

| Performance Specifications | |
|---------------------------------|--|
| Current Rating | 3 AMP |
| Dielectric Withstanding Voltage | 600 VAC Sea Level |
| Voltage | 150 VAC 70,000 Feet |
| Insulation Resistance | 5000 Megohms Minimum |
| Contact Resistance | 8 Milliohms Maximum |
| Low Level Contact Resistance | 32 Milliohms Maximum |
| Magnetic Permeability | 2 μ Maximum |
| Operating Temperature | -55° C. to +150° C. |
| Shock | 50 g. |
| Vibration | 20 g. |
| Outgassing | Meets NASA Outgassing Requirements |
| Mating Force | (10 Ounces) X (# of Contacts) |
| EMI Shielding Effectiveness | 50 dB Attenuation, 100 MHz to 1000 MHz |

For additional performance requirements, please refer to MIL-DTL-83513



| Materials and Finishes | |
|------------------------|---|
| Connector Shell | Plating Code 1: Cadmium With Yellow Chromate Plating Code 2: Electroless Nickel, Plating Code 5: Gold |
| Insulator | Liquid Crystal Polymer (LCP)/Polyphenylene Sulfide (PPS) |
| Interfacial Seal | Fluorosilicone Rubber, Blue |
| Pin Contact | Copper Alloy With 50 Microinches Gold over Nickel Plating |
| Socket Contact | Copper Alloy With 50 Microinches Gold Over Nickel Plating |
| Shield Braid | #36 AWG Nickel-Coated Copper per ASTM B355 Class 4 OFHC 100% AmberStrand® EMI/RFI Conductive Composite Thermoplastic Braided Shielding 75% AmberStrand® Conductive Composite Thermoplastic EMI/RFI Shielding Blended with 25% NiCu EMI/RFI Braided Shielding ArmorLite™ Lightweight Stainless Steel EMI/RFI Shielding |
| Wire | Type K: per MIL-W-22759/11. Silver-Plated Copper Conductor, Extruded TFE fluoropolymer Insulation Type J: per MIL-W-22759/33. Silver-Plated Copper Conductor, Extruded Crosslinked Tefzel® Insulation |
| Hardware | .300 Series Stainless Steel |
| Jacket | Type B: PET Expando Braided Jacket, +125° C. Type C: E-CTFE (Ethylene-Chlorotrifluorethylene) Halar Expando Braided Jacket, +150° C. |
| Encapsulant | Epoxy Resin Hysol EE4215 |

Table II: Dimensions

| Layout | A Max. | | B | | C Max. | | D Max. | | E Max. | | F | | (G) | | (H) | | (J) | | (K) | |
|--------|--------|-------|--------------|--------------|--------|-------|--------|------|--------|-------|--------------|--------------|-------|-------|-------|------|-------|-------|------|-------|
| | In. | mm. | In. ±.003 | mm. ±0.08 | In. | mm. | In. | mm. | In. | mm. | In. ±.003 | mm. ±0.08 | In. | mm. | In. | mm. | In. | mm. | In. | mm. |
| 9P | .785 | 19.94 | .565 | 14.35 | .333 | 8.46 | .184 | 4.67 | .310 | 7.87 | .183 | 4.65 | .340 | 8.64 | .214 | 5.44 | .450 | 11.43 | .324 | 8.23 |
| 9S | .785 | 19.94 | .565 | 14.35 | .400 | 10.16 | .250 | 6.35 | .310 | 7.87 | .195 | 4.95 | .340 | 8.64 | .214 | 5.44 | .450 | 11.43 | .324 | 8.23 |
| 15P | .935 | 23.7 | .715 | 18.16 | .483 | 12.27 | .184 | 4.67 | .310 | 7.87 | .183 | 4.65 | .490 | 12.45 | .214 | 5.44 | .600 | 15.24 | .324 | 8.23 |
| 15S | .935 | 23.7 | .715 | 18.16 | .551 | 14.00 | .250 | 6.35 | .310 | 7.87 | .195 | 4.95 | .490 | 12.45 | .214 | 5.44 | .600 | 15.24 | .324 | 8.23 |
| 21P | 1.085 | 27.56 | .865 | 21.97 | .633 | 16.08 | .184 | 4.67 | .310 | 7.87 | .183 | 4.65 | .640 | 16.26 | .214 | 5.44 | .750 | 19.05 | .324 | 8.23 |
| 21S | 1.085 | 27.56 | .865 | 21.97 | .701 | 17.81 | .250 | 6.35 | .310 | 7.87 | .195 | 4.95 | .640 | 16.26 | .214 | 5.44 | .750 | 19.05 | .324 | 8.23 |
| 25P | 1.185 | 30.10 | .965 | 24.51 | .733 | 18.62 | .184 | 4.67 | .310 | 7.87 | .183 | 4.65 | .740 | 18.80 | .214 | 5.44 | .850 | 21.59 | .324 | 8.23 |
| 25S | 1.185 | 30.10 | .965 | 24.51 | .801 | 20.35 | .250 | 6.35 | .310 | 7.87 | .195 | 4.95 | .740 | 18.80 | .214 | 5.44 | .850 | 21.59 | .324 | 8.23 |
| 31P | 1.335 | 33.91 | 1.115 | 28.32 | .883 | 22.43 | .184 | 4.67 | .310 | 7.87 | .183 | 4.65 | .890 | 22.61 | .214 | 5.44 | 1.000 | 25.40 | .324 | 8.23 |
| 31S | 1.335 | 33.91 | 1.115 | 28.32 | .951 | 24.16 | .250 | 6.35 | .310 | 7.87 | .195 | 4.95 | .890 | 22.61 | .214 | 5.44 | 1.000 | 25.40 | .324 | 8.23 |
| 37P | 1.485 | 37.72 | 1.265 | 32.13 | 1.033 | 26.24 | .184 | 4.67 | .310 | 7.87 | .183 | 4.65 | 1.040 | 26.42 | .214 | 5.44 | 1.150 | 29.21 | .324 | 8.23 |
| 37S | 1.485 | 37.72 | 1.265 | 32.13 | 1.101 | 27.97 | .250 | 6.35 | .310 | 7.87 | .195 | 4.95 | 1.040 | 26.42 | .214 | 5.44 | 1.150 | 29.21 | .324 | 8.23 |
| 51P | 1.435 | 36.45 | 1.215 | 30.86 | .983 | 24.97 | .228 | 5.79 | .351 | 8.92 | .183 | 4.65 | .990 | 25.15 | .257 | 6.53 | 1.100 | 27.94 | .367 | 9.32 |
| 51S | 1.435 | 36.45 | 1.215 | 30.86 | 1.051 | 26.70 | .296 | 7.52 | .351 | 8.92 | .195 | 4.95 | .990 | 25.15 | .257 | 6.53 | 1.100 | 27.94 | .367 | 9.32 |
| 51-2P | 1.835 | 46.61 | 1.615 | 41.02 | 1.384 | 35.15 | .184 | 4.67 | .310 | 7.87 | .183 | 4.65 | 1.390 | 35.31 | .214 | 5.44 | 1.460 | 37.08 | .324 | 8.23 |
| 51-2S | 1.835 | 46.61 | 1.615 | 41.02 | 1.450 | 36.83 | .250 | 6.35 | .310 | 7.87 | .195 | 4.95 | 1.390 | 35.31 | .214 | 5.44 | 1.460 | 37.08 | .324 | 8.23 |
| 67P | 2.235 | 56.77 | 2.015 | 51.18 | 1.784 | 45.31 | .184 | 4.67 | .310 | 7.87 | .183 | 4.65 | 1.790 | 45.47 | .214 | 5.44 | 1.900 | 48.26 | .324 | 8.23 |
| 67S | 2.235 | 56.77 | 2.015 | 51.18 | 1.850 | 46.99 | .250 | 6.35 | .310 | 7.87 | .195 | 4.95 | 1.790 | 45.47 | .214 | 5.44 | 1.900 | 48.26 | .324 | 8.23 |
| 69P | 1.735 | 44.07 | 1.515 | 38.48 | 1.284 | 32.61 | .228 | 5.79 | .351 | 8.92 | .183 | 4.65 | 1.290 | 32.77 | .257 | 6.53 | 1.400 | 35.56 | .367 | 9.32 |
| 69S | 1.735 | 44.07 | 1.515 | 38.48 | 1.350 | 34.29 | .296 | 7.52 | .351 | 8.92 | .195 | 4.95 | 1.290 | 32.77 | .257 | 6.53 | 1.400 | 35.56 | .367 | 9.32 |
| 75P | 2.080 | 52.8 | 1.705 | 43.3 | 1.384 | 35.15 | .224 | 5.68 | .351 | 8.91 | .183 | 4.65 | .416 | 10.6 | 1.440 | 36.6 | .310 | 7.87 | .367 | 9.32 |
| 75S | 2.080 | 52.8 | 1.705 | 43.3 | 1.450 | 36.83 | .293 | 7.44 | .351 | 8.91 | .195 | 4.95 | .429 | 10.9 | 1.440 | 36.6 | .310 | 7.87 | .367 | 9.32 |
| 100P | 2.160 | 54.86 | 1.800 | 45.72 | 1.383 | 35.13 | .270 | 6.86 | .394 | 10.01 | .183 | 4.65 | 1.385 | 35.18 | .307 | 7.80 | 1.495 | 38.00 | .417 | 10.59 |
| 100S | 2.160 | 54.86 | 1.800 | 45.72 | 1.451 | 36.86 | .333 | 8.46 | .394 | 10.01 | .195 | 4.95 | 1.385 | 35.18 | .307 | 7.80 | 1.495 | 38.00 | .417 | 10.59 |
| 130P | 2.520 | 64.00 | 2.160 | 54.86 | 1.735 | 45.59 | .270 | 6.86 | .394 | 10.00 | .183 | 4.65 | 1.712 | 43.48 | .307 | 7.80 | 1.822 | 46.28 | .417 | 10.59 |
| 130S | 2.520 | 64.00 | 2.160 | 54.86 | 1.795 | 45.59 | .333 | 8.46 | .394 | 10.00 | .195 | 4.95 | 1.712 | 43.48 | .307 | 7.80 | 1.822 | 46.28 | .417 | 10.59 |

MWDM Micro-D
Shielded Cable Assembly
177-710 (Untwisted Wire) and 177-740 (Twisted Wire Pairs)



177-740 9 THRU 51 CONTACT TWISTED PAIR WIRING DIAGRAM



9 Contacts



15 Contacts



21 Contacts



25 Contacts



31 Contacts



51 Contacts
2 Row special



37 Contacts



51 Contacts

Micro-D MWDM Metal Shell Uninsulated Wire Connector



B



Micro-D Uninsulated Pigtails—These connectors feature gold-plated TwistPin contacts and mil spec crimp termination to gold-plated solid copper wire. Suitable for soldering or splicing applications, the wire leads can be ordered either gold-plated or solder-dipped.

New One-Piece Socket Contact—An “integral tail” socket contact is now standard on all socket connectors ordered with 24 AWG or 25 AWG, up to one inch of wire. This phosphor bronze contact eliminates the crimp joint and offers greater rigidity.

| How To Order Uninsulated Wire Micro-D Connectors | | | | | | | | | | | |
|--|---|----------|-----------|--|-----------|----------|----------|-----------|-------------|----------|--|
| Sample Part Number | MWDM | 2 | L- | 37 | P- | 5 | C | 4- | .250 | M | |
| Series | MWDM Glenair Micro-D | | | | | | | | | | |
| Shell Material and Finish | Aluminum Shell 1 - Cadmium 2 - Nickel 4 - Black Anodize 5 - Gold 6 - Chem Film | | | Stainless Steel Shell 3 - Passivated | | | | | | | |
| Insulator Material | L - LCP or PPS LCP - 30% Glass-Filled Liquid Crystal Polymer PPS - 40% Glass Filled Polyphenylene Sulfide | | | | | | | | | | |
| Contact Layout | 9, 15, 21, 25, 31, 37, 51, 51-2, 67, 69, 75, 100, 130 (See Table II) | | | | | | | | | | |
| Contact Type | P - Pin S - Socket | | | | | | | | | | |
| Wire Gage (AWG) | 4 - #24 (.020") 5 - #25 (.018") 6 - #26 (.016") | | | | | | | | | | |
| Wire Type | C - Solid Copper | | | | | | | | | | |
| Wire Finish | 3 - Solder-Dipped Sn 60/40 4 - Gold | | | | | | | | | | |
| Wire Length (Inches) | .125, .250, .375, .500, .750, 1.000, 2.000 Wire Length In Inches. ".500" Specifies Half Inch. | | | | | | | | | | |
| Hardware | B, P, M, M1, S, S1, L, K, F, R, H (See Table I) | | | | | | | | | | |

| Table I: Mounting Hardware | | | | | | | | | | |
|----------------------------|----------|--------------------|------------------------------|---------------------|-------------------------------|----------------------------------|--|--------------------------------------|-------------------------------------|-----------------|
| B | P | M | M1 | S | S1 | L | K | F | R | H |
| | | | | | | | | | | |
| Thru-Hole | Jackpost | Hex Head Jackscrew | Hex Head Jackscrew, Extended | Slot Head Jackscrew | Slot Head Jackscrew, Extended | Hex Head Jackscrew Non-Removable | Slot Head Jackscrew Non-Removable Extended | Float Mount For Front Panel Mounting | Float Mount For Rear Panel Mounting | Threaded Insert |



Micro-D MWDM Metal Shell Uninsulated Wire Connector

Table II: Dimensions



| Layout | A Max. | | B | | C Max. | | D Max. | | E Max. | | F | | G Max. | | H Max. | | J Max. | |
|--------|--------|------|---------------|---------------|--------|--------|--------|------|--------|-------|---------------|---------------|--------|-------|--------|-------|--------|------|
| | In. | mm. | In. ± .003 | mm. ± 0.08 | In. | mm. | In. | mm. | In. | mm. | In. ± .003 | mm. ± 0.08 | In. | mm. | In. | mm. | In. | mm. |
| 9P | .785 | 19.9 | .565 | 14.4 | .333 | 8.5 | .184 | 4.7 | .308 | 7.82 | .183 | 4.65 | .416 | 10.57 | .400 | 10.2 | .270 | 6.86 |
| 9S | .785 | 19.9 | .565 | 14.4 | .400 | 10.2 | .250 | 6.35 | .308 | 7.82 | .195 | 4.95 | .429 | 10.90 | .400 | 10.2 | .270 | 6.86 |
| 15P | .935 | 23.8 | .715 | 18.2 | .483 | 12.3 | .184 | 4.7 | .308 | 7.82 | .183 | 4.65 | .416 | 10.57 | .550 | 14.0 | .270 | 6.86 |
| 15S | .935 | 23.8 | .715 | 18.2 | .551 | 14.00 | .250 | 6.4 | .308 | 7.82 | .195 | 4.95 | .429 | 10.90 | .550 | 14.0 | .270 | 6.86 |
| 21P | 1.085 | 27.6 | .865 | 22.0 | .633 | 16.0 | .184 | 4.7 | .308 | 7.82 | .183 | 4.65 | .416 | 10.57 | .700 | 17.8 | .270 | 6.86 |
| 21S | 1.085 | 27.6 | .865 | 22.0 | .701 | 17.8 | .250 | 6.4 | .308 | 7.82 | .195 | 4.95 | .429 | 10.90 | .700 | 17.8 | .270 | 6.86 |
| 25P | 1.185 | 30.0 | .965 | 24.5 | .733 | 18.6 | .184 | 4.7 | .308 | 7.82 | .183 | 4.65 | .416 | 10.57 | .800 | 20.3 | .270 | 6.86 |
| 25S | 1.185 | 30.0 | .965 | 24.5 | .801 | 20.4 | .250 | 6.4 | .308 | 7.82 | .195 | 4.95 | .429 | 10.90 | .800 | 20.3 | .270 | 6.86 |
| 31P | 1.335 | 33.9 | 1.115 | 28.3 | .883 | 22.4 | .184 | 4.7 | .308 | 7.82 | .183 | 4.65 | .416 | 10.57 | .950 | 24.1 | .270 | 6.86 |
| 31S | 1.335 | 33.9 | 1.115 | 28.3 | .951 | 24.2 | .250 | 6.4 | .308 | 7.82 | .195 | 4.95 | .429 | 10.90 | .950 | 24.1 | .270 | 6.86 |
| 37P | 1.485 | 37.7 | 1.265 | 32.1 | 1.033 | 26.2 | .184 | 4.7 | .308 | 7.82 | .183 | 4.65 | .416 | 10.57 | 1.100 | 27.9 | .270 | 6.86 |
| 37S | 1.485 | 37.7 | 1.265 | 32.1 | 1.101 | 28.0 | .250 | 6.4 | .308 | 7.82 | .195 | 4.95 | .429 | 10.90 | 1.100 | 27.9 | .270 | 6.86 |
| 51P | 1.435 | 36.5 | 1.215 | 30.9 | .983 | 28.0 | .228 | 5.8 | .351 | 8.92 | .183 | 4.65 | .416 | 10.57 | 1.050 | 26.7 | .310 | 7.87 |
| 51S | 1.435 | 36.5 | 1.215 | 30.9 | 1.051 | 27.0 | .296 | 7.5 | .351 | 8.92 | .195 | 4.95 | .429 | 10.90 | 1.050 | 26.7 | .310 | 7.87 |
| 51-2P | 1.835 | 46.6 | 1.615 | 41.0 | 1.384 | 35.0 | .184 | 4.7 | .308 | 7.82 | .183 | 4.65 | .416 | 10.57 | 1.450 | 36.8 | .270 | 6.86 |
| 51-2S | 1.835 | 46.6 | 1.615 | 41.0 | 1.450 | 36.8 | .250 | 6.4 | .308 | 7.82 | .195 | 4.95 | .429 | 10.90 | 1.450 | 36.8 | .270 | 6.86 |
| 67P | 2.235 | 56.8 | 2.015 | 51.2 | 1.784 | 45.3 | .184 | 4.7 | .310 | 7.87 | .183 | 4.65 | .416 | 10.57 | 1.850 | 36.8 | .270 | 6.86 |
| 67S | 2.235 | 56.8 | 2.015 | 51.2 | 1.850 | 46.99 | .250 | 6.4 | .310 | 7.87 | .195 | 4.95 | .429 | 10.90 | 1.850 | 36.8 | .270 | 6.86 |
| 69P | 1.735 | 44.1 | 1.515 | 38.5 | 1.284 | 32.61 | .228 | 5.8 | .351 | 8.92 | .183 | 4.65 | .416 | 10.57 | 1.350 | 34.3 | .310 | 7.87 |
| 69S | 1.735 | 44.1 | 1.515 | 38.5 | 1.350 | 34.29 | .296 | 7.5 | .351 | 8.92 | .195 | 4.95 | .429 | 10.90 | 1.350 | 34.3 | .310 | 7.87 |
| 75P | 2.08 | 52.8 | 1.705 | 43.3 | 1.384 | 35.154 | .228 | 5.8 | .351 | 8.9 | .183 | 4.6 | .416 | 10.6 | 1.44 | 36.6 | .310 | 7.9 |
| 75S | 2.08 | 52.8 | 1.705 | 43.3 | 1.45 | 36.83 | .296 | 7.5 | .351 | 8.9 | .195 | 5.0 | .429 | 10.9 | 1.44 | 36.6 | .310 | 7.9 |
| 100P | 2.170 | 55.1 | 1.800 | 45.7 | 1.383 | 35.13 | .270 | 6.9 | .394 | 10.01 | .183 | 4.65 | .416 | 10.57 | 1.442 | 36.6 | .360 | 9.14 |
| 100S | 2.170 | 55.1 | 1.800 | 45.7 | 1.451 | 36.86 | .333 | 8.5 | .394 | 10.01 | .195 | 4.95 | .429 | 10.90 | 1.442 | 36.6 | .360 | 9.14 |
| 130P | 2.52 | 64.0 | 2.15 | 54.6 | 1.735 | 44.1 | .270 | 6.86 | .394 | 10.01 | 0.183 | 4.65 | .416 | 10.57 | 1.780 | 45.21 | .360 | 9.14 |
| 130S | 2.52 | 64.0 | 2.15 | 54.6 | 1.795 | 45.6 | .333 | 8.5 | .394 | 10.01 | 0.195 | 4.95 | .429 | 10.90 | 1.780 | 45.21 | .360 | 9.14 |

| Performance Specifications | |
|----------------------------|-------------------------------|
| Current Rating | 3 AMP |
| DWV | 600 VAC Sea level |
| Insulation Resistance | 5000 Megohms Minimum |
| Contact Resistance | 8 Milliohms Maximum |
| Low Level Contact Resist. | 32 Milliohms Maximum |
| Magnetic Permeability | 2 μ Maximum |
| Operating Temperature | -55° C. to +150° C. |
| Shock, Vibration | 50 g., 20g. |
| Mating Force | (10 Ounces) X (# of Contacts) |

| Materials and Finishes | |
|------------------------|---|
| Connector Shell | Aluminum Alloy 6061 or Stainless Steel, 300 Series, passivated. See Ordering Info for Plating Options |
| Insulator | Liquid Crystal Polymer (LCP) Polyphenylene Sulfide (PPS) |
| Interfacial Seal | Fluorosilicone Rubber, Blue |
| Pin Contact | Copper Alloy, Gold over Nickel Plating |
| Socket Contact | Copper Alloy, Gold Over Nickel Plating |
| Hardware | 300 Series Stainless Steel |
| Encapsulant | Epoxy Resin Hysol EE4215 |

Micro-D Metal Shell GMDR Insulated Wire with Right Angle Exit



Micro-D Right Angle –These connectors feature a space saving right angle exit on either the long or short row and incorporate gold-plated TwistPin contacts and mil spec crimp termination. Specify nickel-plated shells or cadmium plated shells for best availability. 100% tested and backpotted, ready for use.

B

How To Order GMDR Right Angle Exit Connector

| | |
|----------------------------------|---|
| Sample Part Number | GMDR S 2 L- 37 S 6 K 7- 18 B |
| Series | GMDR Glenair Micro-D Right Angle |
| Wire Exit | S - Exit Towards Short Row L - Exit Towards Long Row (See Table I) |
| Shell Material and Finish | Aluminum Shell Stainless Steel Shell 1 - Cadmium 2 - Nickel 3 - Passivated 4 - Black Anodize 5 - Gold 6 - Chem Film |
| Insulator Material | L - LCP or PPS LCP - 30% Glass-Filled Liquid Crystal Polymer PPS - 40% Glass filled polyphenylene sulfide |
| Contact Layout | 9, 15, 21, 25, 31, 37, 51, 51-2, 67, 69, 75, 100, 130 (See Table III) |
| Contact Type | P - Pin S - Socket |
| Wire Gage (AWG) | 4 - #24 6 - #26 8 - #28 0 - #30 (J Wire Only) |
| Wire Type | K - M222759/11 J - M22759/33 E - NEMA HP3-EB |
| Wire Color | 1 - White 2 - Yellow 5 - Color Coded (Full Color) 7 - 10 Color Repeat |
| Wire Length Inches | 18 = 18 inches |
| Hardware | B, P, M, M1, S, S1, L, K, F, R, H, G (See Table II) |

Table I: GMDR Wire Exit

| GMDRL | GMDRS |
|-------|-------|
| | |

Table II: Mounting Hardware

| B | P | M | M1 | S | S1 | L | K | F | R | H |
|-----------|----------|--------------------|------------------------------|---------------------|-------------------------------|----------------------------------|--|--------------------------------------|-------------------------------------|-----------------|
| | | | | | | | | | | |
| Thru-Hole | Jackpost | Hex Head Jackscrew | Hex Head Jackscrew, Extended | Slot Head Jackscrew | Slot Head Jackscrew, Extended | Hex Head Jackscrew Non-Removable | Slot Head Jackscrew Non-Removable Extended | Float Mount For Front Panel Mounting | Float Mount For Rear Panel Mounting | Threaded Insert |



Micro-D Metal Shell GMDR Insulated Wire with Right Angle Exit

B

Table III: Dimensions



| Shell Size | A Max | | B ±.003 | | C Max | | D Max | | E Max | | F ±.003 | | G Max | | H Max | | J Max | |
|------------|-------|------|---------|------|-------|------|-------|-----|-------|------|---------|-----|-------|------|-------|------|-------|-----|
| | in | mm | in | mm | in | mm | in | mm | in | mm | in | mm | in | mm | in | mm | in | mm |
| 9P | 0.785 | 19.9 | 0.565 | 14.4 | 0.333 | 8.5 | 0.184 | 4.7 | 0.308 | 7.8 | 0.183 | 4.6 | 0.416 | 10.6 | 0.400 | 10.2 | 0.270 | 6.9 |
| 9S | 0.785 | 19.9 | 0.565 | 14.4 | 0.400 | 10.2 | 0.250 | 6.4 | 0.308 | 7.8 | 0.195 | 5.0 | 0.429 | 10.9 | 0.400 | 10.2 | 0.270 | 6.9 |
| 15P | 0.935 | 23.7 | 0.715 | 18.2 | 0.483 | 12.3 | 0.184 | 4.7 | 0.308 | 7.8 | 0.183 | 4.6 | 0.416 | 10.6 | 0.550 | 14.0 | 0.270 | 6.9 |
| 15S | 0.935 | 23.7 | 0.715 | 18.2 | 0.551 | 14.0 | 0.250 | 6.4 | 0.308 | 7.8 | 0.195 | 5.0 | 0.429 | 10.9 | 0.550 | 14.0 | 0.270 | 6.9 |
| 21P | 1.085 | 27.6 | 0.865 | 22.0 | 0.633 | 16.1 | 0.184 | 4.7 | 0.308 | 7.8 | 0.183 | 4.6 | 0.416 | 10.6 | 0.700 | 17.8 | 0.270 | 6.9 |
| 21S | 1.085 | 27.6 | 0.865 | 22.0 | 0.701 | 17.8 | 0.250 | 6.4 | 0.308 | 7.8 | 0.195 | 5.0 | 0.429 | 10.9 | 0.700 | 17.8 | 0.270 | 6.9 |
| 25P | 1.185 | 30.1 | 0.965 | 24.5 | 0.733 | 18.6 | 0.184 | 4.7 | 0.308 | 7.8 | 0.183 | 4.6 | 0.416 | 10.6 | 0.800 | 20.3 | 0.270 | 6.9 |
| 25S | 1.185 | 30.1 | 0.965 | 24.5 | 0.801 | 20.3 | 0.250 | 6.4 | 0.308 | 7.8 | 0.195 | 5.0 | 0.429 | 10.9 | 0.800 | 20.3 | 0.270 | 6.9 |
| 31P | 1.335 | 33.9 | 1.115 | 28.3 | 0.883 | 22.4 | 0.184 | 4.7 | 0.308 | 7.8 | 0.183 | 4.6 | 0.416 | 10.6 | 0.950 | 24.1 | 0.270 | 6.9 |
| 31S | 1.335 | 33.9 | 1.115 | 28.3 | 0.951 | 24.2 | 0.250 | 6.4 | 0.308 | 7.8 | 0.195 | 5.0 | 0.429 | 10.9 | 0.950 | 24.1 | 0.270 | 6.9 |
| 37P | 1.485 | 37.7 | 1.265 | 32.1 | 1.033 | 26.2 | 0.184 | 4.7 | 0.308 | 7.8 | 0.183 | 4.6 | 0.416 | 10.6 | 1.100 | 27.9 | 0.270 | 6.9 |
| 37S | 1.485 | 37.7 | 1.265 | 32.1 | 1.101 | 28.0 | 0.250 | 6.4 | 0.308 | 7.8 | 0.195 | 5.0 | 0.429 | 10.9 | 1.100 | 27.9 | 0.270 | 6.9 |
| 51P | 1.435 | 36.4 | 1.215 | 30.9 | 0.983 | 25.0 | 0.228 | 5.8 | 0.351 | 8.9 | 0.183 | 4.6 | 0.416 | 10.6 | 1.050 | 26.7 | 0.310 | 7.9 |
| 51S | 1.435 | 36.4 | 1.215 | 30.9 | 1.051 | 26.7 | 0.296 | 7.5 | 0.351 | 8.9 | 0.195 | 5.0 | 0.429 | 10.9 | 1.050 | 26.7 | 0.310 | 7.9 |
| 51-2P | 1.835 | 46.6 | 1.615 | 41.0 | 1.384 | 35.2 | 0.184 | 4.7 | 0.308 | 7.8 | 0.183 | 4.6 | 0.416 | 10.6 | 1.450 | 36.8 | 0.270 | 6.9 |
| 51-2S | 1.835 | 46.6 | 1.615 | 41.0 | 1.450 | 36.8 | 0.250 | 6.4 | 0.308 | 7.8 | 0.195 | 5.0 | 0.429 | 10.9 | 1.450 | 36.8 | 0.270 | 6.9 |
| 67P | 2.235 | 56.8 | 2.015 | 51.2 | 1.784 | 45.3 | 0.184 | 4.7 | 0.308 | 7.8 | 0.183 | 4.6 | 0.416 | 10.6 | 1.850 | 47.0 | 0.270 | 6.9 |
| 67S | 2.235 | 56.8 | 2.015 | 51.2 | 1.850 | 47.0 | 0.250 | 6.4 | 0.308 | 7.8 | 0.195 | 5.0 | 0.429 | 10.9 | 1.850 | 47.0 | 0.270 | 6.9 |
| 69P | 1.735 | 44.1 | 1.515 | 38.5 | 1.284 | 32.6 | 0.228 | 5.8 | 0.351 | 8.9 | 0.183 | 4.6 | 0.416 | 10.6 | 1.350 | 34.3 | 0.310 | 7.9 |
| 69S | 1.735 | 44.1 | 1.515 | 38.5 | 1.350 | 34.3 | 0.296 | 7.5 | 0.351 | 8.9 | 0.195 | 5.0 | 0.429 | 10.9 | 1.350 | 34.3 | 0.310 | 7.9 |
| 75P | 2.080 | 52.8 | 1.705 | 43.3 | 1.384 | 35.2 | 0.228 | 5.8 | 0.351 | 8.9 | 0.183 | 4.6 | 0.416 | 10.6 | 1.440 | 36.6 | 0.310 | 7.9 |
| 75S | 2.080 | 52.8 | 1.705 | 43.3 | 1.450 | 36.8 | 0.296 | 7.5 | 0.351 | 8.9 | 0.195 | 5.0 | 0.429 | 10.9 | 1.440 | 36.6 | 0.310 | 7.9 |
| 100P | 2.170 | 55.1 | 1.800 | 45.7 | 1.383 | 35.1 | 0.270 | 6.9 | 0.394 | 10.0 | 0.183 | 4.6 | 0.416 | 10.6 | 1.442 | 36.6 | 0.360 | 9.1 |
| 100S | 2.170 | 55.1 | 1.800 | 45.7 | 1.451 | 36.9 | 0.333 | 8.5 | 0.394 | 10.0 | 0.195 | 5.0 | 0.429 | 10.9 | 1.442 | 36.6 | 0.360 | 9.1 |
| 130P | 2.520 | 64.0 | 2.150 | 54.6 | 1.735 | 44.1 | 0.270 | 6.9 | 0.394 | 10.0 | 0.183 | 4.6 | 0.416 | 10.6 | 1.780 | 45.2 | 0.360 | 9.1 |
| 130S | 2.520 | 64.0 | 2.150 | 54.6 | 1.795 | 45.6 | 0.333 | 8.5 | 0.394 | 10.0 | 0.195 | 5.0 | 0.429 | 10.9 | 1.780 | 45.2 | 0.360 | 9.1 |

Performance Specifications

| | |
|---------------------------|-------------------------------|
| Current Rating | 3 AMP |
| DWV | 600 VAC Sea level |
| Insulation Resistance | 5000 Megohms Minimum |
| Contact Resistance | 8 Milliohms Maximum |
| Low Level Contact Resist. | 32 Milliohms Maximum |
| Magnetic Permeability | 2 μ Maximum |
| Operating Temperature | -55° C. to +150° C. |
| Shock, Vibration | 50 g., 20g. |
| Mating Force | (10 Ounces) X (# of Contacts) |

Materials and Finishes

| | |
|------------------|---|
| Connector Shell | Aluminum Alloy 6061 or Stainless Steel, 300 Series, passivated. See Ordering Info for Plating Options |
| Insulator | Liquid Crystal Polymer (LCP) |
| Interfacial Seal | Fluorosilicone Rubber, Blue |
| Pin Contact | Copper Alloy, Gold over Nickel Plating |
| Socket Contact | Copper Alloy, Gold Over Nickel Plating |
| Hardware | 300 Series Stainless Steel |
| Encapsulant | Epoxy Resin Hysol EE4215 |

Micro-D Metal Shell GMDE Environmentally Sealed Rear Panel Mount With O-Ring



RMI



RMI Style

Blind tapped mounting holes with stainless steel inserts accommodate either #4-40 or M3 mounting screws. Connectors are supplied with jackposts installed. Socket connectors feature integral jackposts.



CMI

CMI Style

Space-saving design uses rear panel mount jackposts to attach connectors to the panel.

Choose the Style That Meets Your Needs– **RMI** version features blind tapped mounting holes, allowing secure installation on panels. **CMI** version saves space by using rear panel jackposts to attach the connector.

Mates to Standard M83513 Connectors– GMDE connectors meet the requirements of MIL-DTL-83513 and feature TwistPin contacts for best performance.

Meets MIL-STD-810 Immersion– The nitrile O-ring and a special epoxy wire sealing process allow GMDE connectors to meet immersion requirements.

B

Protect Your Equipment with Ruggedized Micro-D Connectors

Tactical communications boxes must be sealed to prevent water ingress. Standard M83513 type Micro connectors can be difficult to seal to a bulkhead. The flange is too narrow for a gasket, and sealing with RTV can be time-consuming and messy. The Glenair GMDE connector with O-rings provide a better way to seal the connector.

| How To Order GMDE Connectors | | | | | | | | | | |
|------------------------------|---|---|--|----|-----|--|---|----|----|----|
| Sample Part Number | GMDE | 2 | 25 | S- | RMI | 4 | K | 7- | 18 | SM |
| Series | GMDE Glenair Micro-D Environmental | | | | | | | | | |
| Shell Material and Finish | Aluminum Shell 1 - Cadmium 2 - Nickel 4 - Black Anodize 5 - Gold 6 - Chem Film | | Stainless Steel Shell 3 - Passivated | | | | | | | |
| Contact Layout | 9, 15, 21, 25, 31, 37, 51, 51-2, 67, 100 (See Table I) | | | | | | | | | |
| Contact Type | P - Pin S - Socket | | | | | | | | | |
| Flange Style | RMI - Blind Tapped Mounting CMI - Space Saving Rear Panel Mount with Jackposts | | | | | | | | | |
| Wire Gage (AWG) | 4 - #24 6 - #26 8 - #28 0 - #30 (J type only) | | | | | | | | | |
| Wire Type | K - M22759/11 600 VRMS fluoropolymer (TFE) | | J - M22759/33 600 VRMS Modified Cross-Linked Tefzel® (ETFE) | | | E - NEMA HP3-EB 600 VRMS Type E M16878/4 (TFE) | | | | |
| Wire Color | 1 - White 2 - Yellow 5 - Color Coded, Stripes Per MIL-STD-681 (Up to 51 colors) 7 - Ten Color Repeating | | | | | | | | | |
| Wire Length Inches | 18 - Wire Length In Inches. "18" Specifies 18 Inches. | | | | | | | | | |
| Hardware | RMI Style Only SM - Furnished with Jackposts and M3 Mounting Holes SU - Furnished with Jackposts and #4-40 Mounting Holes | | | | | CMI Style Only Jackposts for Rear Panel Mount T - .094 (2.4) V - .062 (1.6) W - .047 (1.2) X - .031 (0.8) Y - .023 (0.65) | | | | |



Micro-D Metal Shell GMDE Environmentally Sealed Rear Panel Mount With O-Ring

Table I: RMI Dimensions



Socket RMI Style Connector



Pin RMI Style Connector

| Layout | A Max. | | B | | C | | D Max. | | E Max. | | F Max. | | G | | H Max. | | J Max. | |
|--------|--------|-------|------------|------------|------------|------------|--------|------|--------|-------|--------|-------|------------|------------|--------|-------|--------|-------|
| | In. | mm. | In. ± .003 | mm. ± 0.08 | In. ± .003 | mm. ± 0.08 | In. | mm. | In. | mm. | In. | mm. | In. ± .003 | mm. ± 0.08 | In. | mm. | In. | mm. |
| 9P | 1.488 | 37.79 | 1.011 | 25.69 | .565 | 14.35 | .184 | 4.67 | .675 | 17.13 | .333 | 8.46 | .183 | 4.65 | 1.193 | 30.29 | .358 | 9.10 |
| 9S | 1.488 | 37.79 | 1.011 | 25.69 | .565 | 14.35 | .250 | 6.35 | .675 | 17.13 | .728 | 18.48 | .195 | 4.95 | 1.193 | 30.29 | .358 | 9.10 |
| 15P | 1.638 | 41.60 | 1.161 | 29.50 | .715 | 18.16 | .184 | 4.67 | .675 | 17.13 | .483 | 12.27 | .183 | 4.65 | 1.343 | 34.10 | .358 | 9.10 |
| 15S | 1.638 | 41.60 | 1.161 | 29.50 | .715 | 18.16 | .250 | 6.35 | .675 | 17.13 | .878 | 22.29 | .195 | 4.95 | 1.343 | 34.10 | .358 | 9.10 |
| 21P | 1.788 | 45.41 | 1.311 | 33.31 | .865 | 21.97 | .184 | 4.67 | .675 | 17.13 | .633 | 16.08 | .183 | 4.65 | 1.532 | 38.91 | .358 | 9.10 |
| 21S | 1.788 | 45.41 | 1.311 | 33.31 | .865 | 21.97 | .250 | 6.35 | .675 | 17.13 | 1.028 | 26.10 | .195 | 4.95 | 1.532 | 38.91 | .358 | 9.10 |
| 25P | 1.888 | 47.95 | 1.411 | 35.85 | .965 | 24.51 | .184 | 4.67 | .675 | 17.13 | .733 | 18.62 | .183 | 4.65 | 1.593 | 40.45 | .358 | 9.10 |
| 25S | 1.888 | 47.95 | 1.411 | 35.85 | .965 | 24.51 | .250 | 6.35 | .675 | 17.13 | 1.128 | 28.64 | .195 | 4.95 | 1.593 | 40.45 | .358 | 9.10 |
| 31P | 2.038 | 51.76 | 1.561 | 39.66 | 1.115 | 28.32 | .184 | 4.67 | .675 | 17.13 | .883 | 22.43 | .183 | 4.65 | 1.743 | 44.26 | .358 | 9.10 |
| 31S | 2.038 | 51.76 | 1.561 | 39.66 | 1.115 | 28.32 | .250 | 6.35 | .675 | 17.13 | 1.278 | 32.45 | .195 | 4.95 | 1.743 | 44.26 | .358 | 9.10 |
| 37P | 2.188 | 55.57 | 1.711 | 43.47 | 1.265 | 32.13 | .184 | 4.67 | .675 | 17.13 | 1.033 | 26.24 | .183 | 4.65 | 1.893 | 48.07 | .358 | 9.10 |
| 37S | 2.188 | 55.57 | 1.711 | 43.47 | 1.265 | 32.13 | .250 | 6.35 | .675 | 17.13 | 1.428 | 36.26 | .195 | 4.95 | 1.893 | 48.07 | .358 | 9.10 |
| 51P | 2.138 | 54.30 | 1.661 | 42.40 | 1.215 | 30.86 | .224 | 5.69 | .714 | 18.13 | .983 | 24.97 | .183 | 4.65 | 1.843 | 46.80 | .358 | 9.10 |
| 51S | 2.138 | 54.30 | 1.661 | 42.40 | 1.215 | 30.86 | .293 | 7.44 | .714 | 18.13 | 1.378 | 34.99 | .195 | 4.95 | 1.843 | 46.80 | .358 | 9.10 |
| 51-2P | 2.538 | 64.46 | 2.061 | 52.36 | 1.615 | 41.02 | .184 | 4.67 | .675 | 17.13 | 1.384 | 35.15 | .183 | 4.65 | 2.243 | 56.96 | .358 | 9.10 |
| 51-2S | 2.538 | 64.46 | 2.061 | 52.36 | 1.615 | 41.02 | .250 | 6.35 | .675 | 17.13 | 1.778 | 45.15 | .195 | 4.95 | 2.243 | 56.96 | .358 | 9.10 |
| 67P | 2.938 | 74.62 | 2.461 | 62.52 | 2.015 | 51.18 | .184 | 5.69 | .675 | 17.13 | 1.783 | 45.28 | .183 | 4.65 | 2.643 | 67.12 | .358 | 9.10 |
| 67S | 2.938 | 74.62 | 2.461 | 62.52 | 2.015 | 51.18 | .250 | 7.44 | .675 | 17.13 | 2.178 | 55.31 | .195 | 4.95 | 2.643 | 67.12 | .358 | 9.10 |
| 100P | 2.820 | 71.62 | 2.312 | 58.72 | 1.800 | 45.72 | .270 | 6.86 | .875 | 22.13 | 1.383 | 35.13 | .183 | 4.65 | 2.493 | 63.32 | .555 | 14.10 |
| 100S | 2.820 | 71.62 | 2.312 | 58.72 | 1.800 | 45.72 | .333 | 8.46 | .875 | 22.13 | 2.002 | 50.85 | .195 | 4.95 | 2.493 | 63.32 | .555 | 14.10 |

Micro-D Metal Shell
GMDE Environmentally Sealed
Rear Panel Mount With O-Ring



Table II: CMI Dimensions



REAR PANEL JACKPOST
9-67 CONTACTS #2-56 UNC-2B
100 CONTACTS #4-40 UNC-2B



| Layout | A Max. | | B | | C Max. | | D Max. | | E Max. | | F Max. | | G Max. | | H Max. | | J Max. | |
|--------|--------|-------|------------|------------|--------|-------|--------|------|--------|-------|------------|------------|--------|-------|--------|-------|--------|-------|
| | In. | mm. | In. ± .003 | mm. ± 0.08 | In. | mm. | In. | mm. | In. | mm. | In. ± .003 | mm. ± 0.08 | In. | mm. | In. | mm. | In. | mm. |
| 9P | 1.025 | 26.03 | .565 | 14.35 | .333 | 8.46 | .184 | 4.67 | .675 | 17.13 | .183 | 4.65 | .510 | 12.95 | .835 | 21.21 | .358 | 9.10 |
| 9S | 1.025 | 26.03 | .565 | 14.35 | .400 | 10.16 | .250 | 6.35 | .675 | 17.13 | .195 | 4.95 | .526 | 13.36 | .835 | 21.21 | .358 | 9.10 |
| 15P | 1.135 | 28.83 | .715 | 18.16 | .483 | 12.27 | .184 | 4.67 | .675 | 17.13 | .183 | 4.65 | .510 | 12.95 | .950 | 24.13 | .358 | 9.10 |
| 15S | 1.135 | 28.83 | .715 | 18.16 | .551 | 14.00 | .250 | 6.35 | .675 | 17.13 | .195 | 4.95 | .526 | 13.36 | .950 | 24.13 | .358 | 9.10 |
| 21P | 1.325 | 33.63 | .865 | 21.97 | .633 | 16.08 | .184 | 4.67 | .675 | 17.13 | .183 | 4.65 | .510 | 12.95 | 1.090 | 27.63 | .358 | 9.10 |
| 21S | 1.325 | 33.63 | .865 | 21.97 | .701 | 17.81 | .250 | 6.35 | .675 | 17.13 | .195 | 4.95 | .526 | 13.36 | 1.090 | 27.63 | .358 | 9.10 |
| 25P | 1.430 | 36.33 | .965 | 24.51 | .733 | 18.62 | .184 | 4.67 | .675 | 17.13 | .183 | 4.65 | .510 | 12.95 | 1.190 | 30.13 | .358 | 9.10 |
| 25S | 1.430 | 36.33 | .965 | 24.51 | .801 | 20.35 | .250 | 6.35 | .675 | 17.13 | .195 | 4.95 | .526 | 13.36 | 1.190 | 30.13 | .358 | 9.10 |
| 31P | 1.580 | 40.09 | 1.115 | 28.32 | .883 | 22.43 | .184 | 4.67 | .675 | 17.13 | .183 | 4.65 | .510 | 12.95 | 1.345 | 34.13 | .358 | 9.10 |
| 31S | 1.580 | 40.09 | 1.115 | 28.32 | .951 | 24.16 | .250 | 6.35 | .675 | 17.13 | .195 | 4.95 | .526 | 13.36 | 1.345 | 34.13 | .358 | 9.10 |
| 37P | 1.725 | 43.83 | 1.265 | 32.13 | 1.033 | 26.24 | .184 | 4.67 | .675 | 17.13 | .183 | 4.65 | .510 | 12.95 | 1.505 | 38.13 | .358 | 9.10 |
| 37S | 1.725 | 43.83 | 1.265 | 32.13 | 1.101 | 27.96 | .250 | 6.35 | .675 | 17.13 | .195 | 4.95 | .526 | 13.36 | 1.505 | 38.13 | .358 | 9.10 |
| 51P | 1.675 | 42.53 | 1.215 | 30.86 | .983 | 24.97 | .224 | 5.69 | .714 | 18.14 | .183 | 4.65 | .510 | 12.95 | 1.445 | 36.63 | .358 | 9.10 |
| 51S | 1.675 | 42.53 | 1.215 | 30.86 | 1.051 | 26.70 | .293 | 7.44 | .714 | 18.14 | .195 | 4.95 | .526 | 13.36 | 1.445 | 36.63 | .358 | 9.10 |
| 51-2P | 2.075 | 52.63 | 1.615 | 41.02 | 1.384 | 35.15 | .184 | 4.67 | .675 | 17.13 | .183 | 4.65 | .510 | 12.95 | 1.835 | 46.63 | .358 | 9.10 |
| 51-2S | 2.075 | 52.63 | 1.615 | 41.02 | 1.450 | 36.83 | .250 | 6.35 | .675 | 17.13 | .195 | 4.95 | .526 | 13.36 | 1.835 | 46.63 | .358 | 9.10 |
| 67P | 2.465 | 62.63 | 2.015 | 51.18 | 1.284 | 32.61 | .184 | 5.69 | .675 | 17.13 | .183 | 4.65 | .510 | 12.95 | 2.250 | 57.13 | .358 | 9.10 |
| 67S | 2.465 | 62.63 | 2.015 | 51.18 | 1.350 | 34.29 | .250 | 7.44 | .675 | 17.13 | .195 | 4.95 | .526 | 13.36 | 2.250 | 57.13 | .358 | 9.10 |
| 100P | 2.600 | 63.50 | 1.800 | 45.72 | 1.383 | 35.13 | .270 | 6.86 | .875 | 22.13 | .183 | 4.65 | .585 | 14.83 | 2.135 | 54.13 | .555 | 14.10 |
| 100S | 2.600 | 63.50 | 1.800 | 45.72 | 1.451 | 36.86 | .333 | 8.46 | .875 | 22.13 | .195 | 4.95 | .600 | 15.24 | 2.135 | 54.13 | .555 | 14.10 |



Micro-D Metal Shell GMDE Environmentally Sealed Panel Mount With O-Ring

Table III: GMDE Panel Cutout Dimensions

RMI Version



CMI Version



| Layout | A | | B | | C | | D | | E | | F | | G | |
|-------------|---------------|---------------|---------------|---------------|------------------|------------------|---------------|---------------|---------------|---------------|---------------|---------------|---------------|---------------|
| | In. ± .003 | mm. ± 0.08 | In. ± .005 | mm. ± 0.13 | In. + .005/-0 | mm. + 0.13/-0 | In. ± .005 | mm. ± 0.13 | In. ± .005 | mm. ± 0.13 | In. ± .002 | mm. ± 0.05 | In. ± .005 | mm. ± 0.13 |
| 9 | 1.011 | 25.69 | .731 | 18.56 | .252 | 6.40 | .565 | 14.35 | .406 | 10.31 | .126 | 3.20 | .256 | 6.50 |
| 15 | 1.161 | 29.50 | .881 | 22.37 | .252 | 6.40 | .715 | 18.16 | .556 | 14.12 | .126 | 3.20 | .256 | 6.50 |
| 21 | 1.311 | 33.31 | 1.031 | 26.18 | .252 | 6.40 | .865 | 21.97 | .706 | 17.93 | .126 | 3.20 | .256 | 6.50 |
| 25 | 1.411 | 35.85 | 1.131 | 28.72 | .252 | 6.40 | .965 | 24.51 | .806 | 20.47 | .126 | 3.20 | .256 | 6.50 |
| 31 | 1.561 | 39.66 | 1.281 | 32.53 | .252 | 6.40 | 1.115 | 28.32 | .956 | 24.28 | .126 | 3.20 | .256 | 6.50 |
| 37 | 1.711 | 43.47 | 1.431 | 36.34 | .252 | 6.40 | 1.265 | 32.13 | 1.106 | 28.09 | .126 | 3.20 | .256 | 6.50 |
| 51 | 1.661 | 42.20 | 1.381 | 35.07 | .295 | 7.50 | 1.215 | 30.86 | 1.056 | 26.82 | .126 | 3.20 | .300 | 7.62 |
| 51-2 | 2.061 | 52.36 | 1.781 | 45.23 | .252 | 6.40 | 1.615 | 41.02 | 1.456 | 36.98 | .126 | 3.20 | .256 | 6.50 |
| 67 | 2.461 | 62.52 | 2.181 | 55.39 | .252 | 6.40 | 2.015 | 51.18 | 2.606 | 66.19 | .126 | 3.20 | .256 | 6.50 |
| 100 | 2.312 | 58.72 | 2.005 | 50.93 | .333 | 8.47 | 1.800 | 45.72 | 1.520 | 38.61 | .148 | 3.76 | .406 | 10.31 |

**Micro-D GSWM
SpaceWire Cable Assembly
in Back-to-Back or Single Ended Wire Configurations**



Single-Ended or Double-Ended—These easy-to-order cable assemblies eliminate the need for expensive assembly labor. 100% tested and ready for use.

High Performance Insulation—Expanded polytetrafluoroethylene (EPTFE) allows for the support of LVDS technology to significantly reduce data loss while allowing for the implementation of standard hardware protocols, thus eliminating the need for design customizations while reducing costs.

Cost Saving, Easy Integration and High-Performance for Flight and Lab Grade Data Transmission.

The success of any space mission begins with reliable data transmission and Glenair SpaceWire cables, built to meet the strict standards set forth by ECSS-E-ST-50-12C, make this a reality. Our SpaceWire cables offer bidirectional, high speed data transmission rates up to 400 Mbits/s while significantly reducing cross talk, skew, and signal attenuation. By incorporating a serial, point-to-point cable, with low voltage differential signaling (LVDS) reduced costs are realized through an easily integrated data transmission cable. These features allow SpaceWire cables to be incorporated across various satellite programs without the expense of costly design customization.

| How To Order SpaceWire Cable Assembly | | | | | | | | | | | |
|---------------------------------------|------------------------------------|---|------------|----|-------------------------------------|---------------------|---|---|-----|---|--|
| Sample Part Number | GSWM | 2 | L | -9 | GP | -6 | F | B | -16 | S | |
| Product Series | GSWM Glenair SpaceWire Micro-D | | | | | | | | | | |
| Shell Plating | 2 - Electroless Nickel | | 5 - Gold | | | | | | | | |
| Insulator Material | L - LCP | | | | | | | | | | |
| Shell Size | 9 | | | | | | | | | | |
| Connector Type | P - Single Ended Pin (Plug) | | | | GP - Pin (Plug) Connector Both Ends | | | | | | |
| Wire Gauge | 6 - 26 AWG | | 8 - 28 AWG | | 0 - 30 AWG (30 AWG—Lab Only) | | | | | | |
| Cable Type | F - Flight Grade | | | | L - Lab Grade | | | | | | |
| Termination Option | B - Backshell | | | | | | | | | | |
| Cable Length In Inches | 16 - 16 inches (12 inches minimum) | | | | | | | | | | |
| Hardware | S - Male Slotted Jackscrew | | | | | P - Female Jackpost | | | | | |

B

Back To Back Wiring
Diagram (GP)



Single Ended Wiring
Diagram (P)



Notes:

1. Flight grade (cable Type F) assemblies to be screened IAW NASA EEE-INST-002, Table 2. Level 1 with 100% thermal vacuum outgassing (24 hours/ $+125^{\circ}\text{C}/10^{-6}$ torr). Reference Glenair Mod Code 429C.
2. Operating temperature - 200°C to $+180^{\circ}\text{C}$. Reference Glenair Mod Code 428.
3. Electrical performance:
Dielectric withstanding voltage: 600 VAC.
Insulation resistance: 5000 megohms @500 VDC.
4. Assembly to be identified with Glenair's name, Part Number, Cage Code and Date Code or ESCC Component Part Marking Standards.

Materials/finish:

- Shells/backshells - aluminum alloy/electroless nickel.
- Insulators - high grade rigid dielectric/N.A.
- Contacts - copper alloy, gold plated.
- Hardware - stainless steel/passivated.

Micro-D GMLM MasterLatch® Pre-Wired Latching Micro-D Connector with Insulated Wire



MasterLatch® Micro-D (GMLM) Quick-release locking Micro-D connector pairs are equipped with a precision latching and locking mechanism. The single thumb latch on the plug side actuates a pair of locking latches that mate quickly and reliably to GMLM receptacles. These TwistPin equipped, low-insertion-force connectors meet all the standard performance requirements of MIL-DTL-8513 including vibration, shock, and mating durability. Choose from 6 different insert arrangements from 9 to 37 contacts. The unique ergonomic latching mechanism can be easily activated with a thumb and forefinger grip even when wearing gloves, or when difficult access to connector pairs makes the use of jacking hardware and tools impossible.

How To Order GMLM MasterLatch®

| | |
|-------------------------------|--|
| Sample Part Number | GMLM 2 L -25 P -6 K 7 -18 |
| Product Series | GMLM Glenair MasterLatch® Micro-D |
| Shell Plating | 1 - Cadmium 2 - Nickel 4 - Black Anodize 5 - Gold 6 - Chem Film |
| Insulator Material | L - LCP or PPS |
| Contact Layout | 9, 15, 21, 25, 31, 37 |
| Connector Type | P - Pin (Plug) S - Socket (Receptacle) |
| Wire Gauge | 4 - 24 AWG 6 - 26 AWG 8 - 28 AWG 0 - 30 AWG (J Wire Only) |
| Wire Type | K - M22759/11 60 Vrms Fluoropolymer J - M22759/33 600 Vrms Modified Cross-Linked Tefzel (ETFE) |
| Wire Color Code | 1 - White 2 - Yellow 5 - Color Coded 7 - Ten Color Repeating |
| Cable Length In Inches | 18 - 18 inches |

Materials and Finishes

| | |
|------------------|---|
| Connector Shell | Aluminum Alloy 6061 or Stainless Steel, 300 Series, passivated. See Ordering Info for Plating Options |
| Insulator | Liquid Crystal Polymer (LCP) or Polyphenylene Sulfide (PPS) |
| Interfacial Seal | Fluorosilicone Rubber, Blue |
| Pin Contact | Beryllium Copper Gold over Nickel Plating |
| Socket Contact | Copper Alloy Gold Over Nickel Plating |
| Hardware | 300 Series Stainless Steel |
| Encapsulant | Epoxy Resin Hysol EE4215 |

Performance Specifications

| | |
|---------------------------|-------------------------------|
| Current Rating | 3 AMP |
| DWV | 600 VAC Sea level |
| Insulation Resistance | 5000 Megohms Minimum |
| Contact Resistance | 8 Milliohms Maximum |
| Low Level Contact Resist. | 32 Milliohms Maximum |
| Magnetic Permeability | 2 μ Maximum |
| Operating Temperature | -55° C. to +150° C. |
| Shock, Vibration | 50 g., 20g. |
| Mating Force | (10 Ounces) X (# of Contacts) |



Micro-D GMLM MasterLatch® Pre-Wired Latching Micro-D Connector with Insulated Wire

B

GMLM MasterLatch Dimensions



| Layout | A Max | | B Max | | C | | D Max | | E Max | | F Max | | G | |
|--------|-------|-------|-------|-------|-------|------|-------|-------|-------|------|-------|-------|-------|------|
| | In | mm | In | mm | In | mm | In | mm | In | mm | In | mm | In | mm |
| 9P | 0.785 | 19.94 | 0.333 | 8.46 | 0.320 | 8.13 | 0.610 | 15.49 | 0.290 | 7.37 | 0.400 | 10.16 | 0.183 | 4.65 |
| 9S | 0.785 | 19.94 | 0.342 | 8.69 | 0.320 | 8.13 | 0.429 | 10.90 | 0.295 | 7.49 | 0.400 | 10.16 | N/A | N/A |
| 15P | 0.935 | 23.75 | 0.483 | 12.27 | 0.320 | 8.13 | 0.610 | 15.49 | 0.290 | 7.37 | 0.550 | 13.97 | 0.183 | 4.65 |
| 15S | 0.935 | 23.75 | 0.492 | 12.50 | 0.320 | 8.13 | 0.429 | 10.90 | 0.295 | 7.49 | 0.550 | 13.97 | N/A | N/A |
| 21P | 1.085 | 27.56 | 0.633 | 16.08 | 0.320 | 8.13 | 0.610 | 15.49 | 0.290 | 7.37 | 0.700 | 17.78 | 0.183 | 4.65 |
| 21S | 1.085 | 27.56 | 0.642 | 16.31 | 0.320 | 8.13 | 0.429 | 10.90 | 0.295 | 7.49 | 0.700 | 17.78 | N/A | N/A |
| 25P | 1.185 | 30.10 | 0.733 | 18.62 | 0.320 | 8.13 | 0.610 | 15.49 | 0.290 | 7.37 | 0.800 | 20.32 | 0.183 | 4.65 |
| 25S | 1.185 | 30.10 | 0.742 | 18.85 | 0.320 | 8.13 | 0.429 | 10.90 | 0.295 | 7.49 | 0.800 | 20.32 | N/A | N/A |
| 31P | 1.335 | 33.91 | 0.883 | 22.43 | 0.320 | 8.13 | 0.610 | 15.49 | 0.290 | 7.37 | 0.950 | 24.13 | 0.183 | 4.65 |
| 31S | 1.335 | 33.91 | 0.892 | 22.66 | 0.320 | 8.13 | 0.429 | 10.90 | 0.295 | 7.49 | 0.950 | 24.13 | N/A | N/A |
| 37P | 1.485 | 37.72 | 1.033 | 26.24 | 0.320 | 8.13 | 0.610 | 15.49 | 0.290 | 7.37 | 1.100 | 27.94 | 0.183 | 4.65 |
| 37S | 1.485 | 37.72 | 1.042 | 26.47 | 0.320 | 8.13 | 0.429 | 10.90 | 0.295 | 7.49 | 1.100 | 27.94 | N/A | N/A |

Section C
Micro-D Metal Shell
Printed Circuit Board Connectors



Product Selection Guide



GRPM Condensed Board, Rear Panel Mount Connector

GRPM CBS, Condensed Board Straight, .100" x .075" Pitch..... **Page C-2**
GRPM CBR, Condensed Board Right Angle, .100" x .100" Pitch..... **Page C-4**



MWDM Thru-Hole

MWDM BS, Vertical, .100" X .100" Pitch..... **Page C-6**
MWDM BR, Right Angle, .100" X .100" Pitch..... **Page C-10**



MWDM Condensed Board, Thru-Hole

MWDM CBS, Condensed Board Straight, .100" X .075" Pitch **Page C-14**
MWDM CBR, Condensed Board Right Angle, .100" X .100" Pitch **Page C-22**



MWDM Surface Mount

MWDM Right Angle, .025" Between PCB Terminals **Page C-28**



GMR75 Condensed Board, Thru-Hole

GMR7580 Vertical, .075" X .075" Pitch **Page C-32**
GMR7590 Right Angle, .075" X .075" Pitch **Page C-36**



GMR75C Compact Flange

GMR 7580 Vertical, .075" X .075" Pitch..... **Page C-40**
GMR 7590 Right Angle, .075" X .075" Pitch **Page C-44**



GMLM MasterLatch®

GMLMR CBS Condensed Board Straight, Vertical, .100" X .075" Pitch **Page C-48**
GMLMR CBR Condensed Board Right Angle, .100" X .100" Pitch **Page C-50**



Micro-D GRPM-CBS Condensed Vertical Rear Panel Mount Wide Flange Printed Circuit Board Connectors



Save Space On Your Circuit Board – These Micro-D connectors feature .075 inch row spacing. The board footprint is reduced to match the size of the connector body.

Solder-Dipped – Terminals are coated with Sn60/Pb40 tin-lead solder for best solderability. Optional gold-plated terminals are available for RoHS compliance.

High Performance – These connectors meet the demanding requirements of MIL-DTL-83513.

How To Order GRPM Condensed Vertical Connector

| Sample Part Number | GRPM | 2 | L- | 15 | P | CBS | R3 | T | N | -.110 | 513 | | | |
|----------------------------------|--|---|---|----|-----------------|-----|-----------------|---|-----------------|-------|-----------------|--|-----------------|--|
| Series | GRPM Glenair Rear Panel Mount | | | | | | | | | | | | | |
| Shell Material and Finish | Aluminum Shell 1 - Cadmium 2 - Nickel 4 - Black Anodize 5 - Gold 6 - Chem Film | | Stainless Steel Shell 3 - Passivated | | | | | | | | | | | |
| Insulator Material | L - LCP or PPS LCP - 30% Glass-Filled Liquid Crystal Polymer PPS - 40% Glass Filled Polyphenylene Sulfide | | | | | | | | | | | | | |
| Contact Layout | 9, 15, 21, 25, 31, 37, 51-2, 51, 69, 75, 100, 130 (See Table I) | | | | | | | | | | | | | |
| Contact Type | P – Pin S – Socket | | | | | | | | | | | | | |
| Termination Type | CBS - Condensed Board Straight | | | | | | | | | | | | | |
| Rear Panel Mount Hardware Option | B - No hardware | | R1 - .032 panel | | R2 - .047 panel | | R3 - .062 panel | | R4 - .093 panel | | R5 - .125 panel | | R6 - .080 panel | |
| Threaded Insert Option | T - Threaded Insert in Board Mount Hole Omit for none 9-69 Contacts - 2-56 75-130 Contacts - 4-40 | | | | | | | | | | | | | |
| O-Ring | C - Conductive N - Non-Conductive (Nitrile) | | | | | | | | | | | | | |
| Lead Length | .080, .110, .125, .140, .150, .172, .190, .250 | | | | | | | | | | | | | |
| Gold-Plated Terminal Mod Code | These connectors are solder-dipped in 60/40 tin-lead solder. To delete the solder dip and change to gold-plated terminals, add code 513 | | | | | | | | | | | | | |

Materials and Finishes

| | |
|------------------|---|
| Connector Shell | Aluminum Alloy 6061 or Stainless Steel, 300 Series, passivated. See Ordering Info for Plating Options |
| Insulator | Liquid Crystal Polymer (LCP) or Polyphenylene Sulfide (PPS) |
| Interfacial Seal | Fluorosilicone Rubber, Blue |
| Pin Contact | Beryllium Copper Gold over Nickel Plating |
| Socket Contact | Copper Alloy Gold Over Nickel Plating |
| Hardware | 300 Series Stainless Steel |
| Encapsulant | Epoxy Resin Hysol EE4215 |

Performance Specifications

| | |
|------------------------------|-------------------------------|
| Current Rating | 3 AMP |
| DWV | 600 VAC Sea level |
| Insulation Resistance | 5000 Megohms Minimum |
| Contact Resistance | 8 Milliohms Maximum |
| Low Level Contact Resistance | 32 Milliohms Maximum |
| Magnetic Permeability | 2 μ Maximum |
| Operating Temperature | -55° C. to +150° C. |
| Shock, Vibration | 50 g., 20g. |
| Mating Force | (10 Ounces) X (# of Contacts) |

Notes:

- Performance data per MIL-DTL-83513
- Interface dimensions per MIL-DTL-83513

- PCB layout per Glenair MWDMCBS catalog data. See Section C

Micro-D GRPM-CBS Condensed Vertical Rear Panel Mount Wide Flange Printed Circuit Board Connectors



Table I: Dimensions



| Layout | A | | B | | C Max | | D | | E Max | | F ±.003 | | G Max | | H Max | | J Max | |
|--------|--------------|-------------|--------------|-------------|-------|-------|--------------|-------------|-------|------|--------------|-------------|-------|-------|-------|-------|-------|-------|
| | in. ±.005 | mm. ±.13 | in. ±.003 | mm. ±.08 | in. | mm. | in. ±.005 | mm. ±.13 | in. | mm. | in. ±.003 | mm. ±.08 | in. | mm. | in. | mm. | in. | mm. |
| 9P | 0.960 | 24.38 | 0.565 | 14.35 | 0.334 | 8.48 | 0.480 | 12.19 | 0.184 | 4.67 | 0.183 | 4.65 | 0.555 | 14.10 | 0.785 | 19.94 | 0.310 | 7.87 |
| 9S | 0.960 | 24.38 | 0.565 | 14.35 | 0.400 | 10.16 | 0.480 | 12.19 | 0.250 | 6.35 | 0.195 | 4.95 | 0.555 | 14.10 | 0.785 | 19.94 | 0.310 | 7.87 |
| 15P | 1.110 | 28.19 | 0.715 | 18.16 | 0.484 | 12.29 | 0.480 | 12.19 | 0.184 | 4.67 | 0.183 | 4.65 | 0.555 | 14.10 | 0.935 | 23.75 | 0.310 | 7.87 |
| 15S | 1.110 | 28.19 | 0.715 | 18.16 | 0.550 | 13.97 | 0.480 | 12.19 | 0.250 | 6.35 | 0.195 | 4.95 | 0.555 | 14.10 | 0.935 | 23.75 | 0.310 | 7.87 |
| 21P | 1.260 | 32.00 | 0.865 | 21.97 | 0.634 | 16.10 | 0.480 | 12.19 | 0.184 | 4.67 | 0.183 | 4.65 | 0.555 | 14.10 | 1.085 | 27.56 | 0.310 | 7.87 |
| 21S | 1.260 | 32.00 | 0.865 | 21.97 | 0.700 | 17.78 | 0.480 | 12.19 | 0.250 | 6.35 | 0.195 | 4.95 | 0.555 | 14.10 | 1.085 | 27.56 | 0.310 | 7.87 |
| 25P | 1.360 | 34.54 | 0.965 | 24.51 | 0.734 | 18.64 | 0.480 | 12.19 | 0.184 | 4.67 | 0.183 | 4.65 | 0.555 | 14.10 | 1.185 | 30.10 | 0.310 | 7.87 |
| 25S | 1.360 | 34.54 | 0.965 | 24.51 | 0.800 | 20.32 | 0.480 | 12.19 | 0.250 | 6.35 | 0.195 | 4.95 | 0.555 | 14.10 | 1.185 | 30.10 | 0.310 | 7.87 |
| 31P | 1.510 | 38.35 | 1.115 | 28.32 | 0.884 | 22.45 | 0.480 | 12.19 | 0.184 | 4.67 | 0.183 | 4.65 | 0.555 | 14.10 | 1.335 | 33.91 | 0.310 | 7.87 |
| 31S | 1.510 | 38.35 | 1.115 | 28.32 | 0.950 | 24.13 | 0.480 | 12.19 | 0.250 | 6.35 | 0.195 | 4.95 | 0.555 | 14.10 | 1.335 | 33.91 | 0.310 | 7.87 |
| 37P | 1.660 | 42.16 | 1.265 | 32.13 | 1.034 | 26.26 | 0.480 | 12.19 | 0.184 | 4.67 | 0.183 | 4.65 | 0.555 | 14.10 | 1.485 | 37.72 | 0.310 | 7.87 |
| 37S | 1.660 | 42.16 | 1.265 | 32.13 | 1.100 | 27.94 | 0.480 | 12.19 | 0.250 | 6.35 | 0.195 | 4.95 | 0.555 | 14.10 | 1.485 | 37.72 | 0.310 | 7.87 |
| 51-2P | 2.010 | 51.05 | 1.615 | 41.02 | 1.384 | 35.15 | 0.480 | 12.19 | 0.184 | 4.67 | 0.183 | 4.65 | 0.555 | 14.10 | 1.835 | 46.61 | 0.310 | 7.87 |
| 51-2S | 2.010 | 51.05 | 1.615 | 41.02 | 1.450 | 36.83 | 0.480 | 12.19 | 0.250 | 6.35 | 0.195 | 4.95 | 0.555 | 14.10 | 1.835 | 46.61 | 0.310 | 7.87 |
| 51P | 1.660 | 42.16 | 1.215 | 30.86 | 0.984 | 24.99 | 0.525 | 13.34 | 0.224 | 5.69 | 0.183 | 4.65 | 0.555 | 14.10 | 1.435 | 36.45 | 0.400 | 10.16 |
| 51S | 1.660 | 42.16 | 1.215 | 30.86 | 1.050 | 26.67 | 0.525 | 13.34 | 0.293 | 7.44 | 0.195 | 4.95 | 0.555 | 14.10 | 1.435 | 36.45 | 0.400 | 10.16 |
| 69P | 1.960 | 49.78 | 1.515 | 38.48 | 1.284 | 32.61 | 0.525 | 13.34 | 0.224 | 5.69 | 0.183 | 4.65 | 0.555 | 14.10 | 1.735 | 44.07 | 0.400 | 10.16 |
| 69S | 1.960 | 49.78 | 1.515 | 38.48 | 1.358 | 34.49 | 0.525 | 13.34 | 0.293 | 7.44 | 0.195 | 4.95 | 0.555 | 14.10 | 1.735 | 44.07 | 0.400 | 10.16 |
| 75P | 2.150 | 54.61 | 1.705 | 43.31 | 1.384 | 35.15 | 0.525 | 13.34 | 0.224 | 5.69 | 0.183 | 4.65 | 0.555 | 14.10 | 2.080 | 52.83 | 0.400 | 10.16 |
| 75S | 2.150 | 54.61 | 1.705 | 43.31 | 1.450 | 36.83 | 0.525 | 13.34 | 0.293 | 7.44 | 0.195 | 4.95 | 0.555 | 14.10 | 2.080 | 52.83 | 0.400 | 10.16 |
| 100P | 2.385 | 60.58 | 1.800 | 45.72 | 1.384 | 35.15 | 0.600 | 15.24 | 0.270 | 6.86 | 0.183 | 4.65 | 0.640 | 16.26 | 2.170 | 55.12 | 0.510 | 12.95 |
| 100S | 2.385 | 60.58 | 1.800 | 45.72 | 1.451 | 36.86 | 0.600 | 15.24 | 0.333 | 8.46 | 0.195 | 4.95 | 0.640 | 16.26 | 2.170 | 55.12 | 0.510 | 12.95 |
| 130P | 2.735 | 69.47 | 2.150 | 54.61 | 1.735 | 44.07 | .600 | 15.24 | .270 | 6.86 | .183 | 4.65 | .640 | 16.26 | 2.520 | 64.01 | .510 | 12.95 |
| 130S | 2.735 | 69.47 | 2.150 | 54.61 | 1.795 | 45.60 | .600 | 15.24 | .333 | 8.46 | .195 | 4.95 | .640 | 16.26 | 2.520 | 64.01 | .510 | 12.95 |



Micro-D GRPM-CBR Right Angle Rear Panel Mount Wide Flange Printed Circuit Board Connectors



Save Space On Your Circuit Board – These Micro-D connectors feature .100 inch row spacing. The board footprint is reduced to match the size of the connector body.

Solder-Dipped – Terminals are coated with Sn60/Pb40 tin-lead solder for best solderability. Optional gold-plated terminals are available for RoHS compliance.

High Performance – These connectors meet all MIL-DTL-83513 requirements.

How To Order GRPM Right Angle Connectors

| Sample Part Number | GRPM | 2 | L- | 15 | P | CBR | R3 | T | N | -.110 | 513 |
|----------------------------------|--|-----------------|-----------------------|----|-----------------|-----|----|---|---|-------|-----|
| Series | GRPM - Glenair Right Angle Rear Panel Micro | | | | | | | | | | |
| Shell Material and Finish | Aluminum Shell | | Stainless Steel Shell | | | | | | | | |
| | 1 - Cadmium | 2 - Nickel | 3 - Passivated | | | | | | | | |
| | 4 - Black Anodize | | | | | | | | | | |
| | 5 - Gold | | 6 - Chem Film | | | | | | | | |
| Insulator Material | L - LCP or Ryton LCP - 30% Glass-Filled Liquid Crystal Polymer PPS - 40% Glass-Filled Polyphenylene Sulfide | | | | | | | | | | |
| Contact Layout | 9, 15, 21, 25, 31, 37, 51-2, 51, 69, 75, 100, 130 (See Table I) | | | | | | | | | | |
| Contact Type | P - Pin S - Socket | | | | | | | | | | |
| Termination Type | CBR - Condensed Board Right Angle | | | | | | | | | | |
| Rear Panel Mount Hardware Option | B - No hardware | R1 - .032 panel | R2 - .047 panel | | | | | | | | |
| | R3 - .062 panel | R4 - .093 panel | R5 - .125 panel | | R6 - .080 panel | | | | | | |
| Threaded Insert Option | T - Threaded Insert in Board Mount Hole; 9 thru 69 Contacts use 2-56; 75-130 Contacts use 4-40 Omit for none | | | | | | | | | | |
| O-Ring | C - Conductive N - Non Conductive (Nitrile) | | | | | | | | | | |
| Lead Length | .080, .110, .125, .140, .150, .172, .190, .250 | | | | | | | | | | |
| Gold-Plated Terminal Mod Code | These connectors are solder-dipped in 60/40 tin-lead solder. To delete the solder dip and change to gold-plated terminals, add code 513 | | | | | | | | | | |

Materials and Finishes

| | |
|------------------|---|
| Connector Shell | Aluminum Alloy 6061 or Stainless Steel, 300 Series, passivated. See Ordering Info for Plating Options |
| Insulator | Liquid Crystal Polymer (LCP) or Polyphenylene Sulfide (PPS) |
| Interfacial Seal | Fluorosilicone Rubber, Blue |
| Pin Contact | Beryllium Copper Gold over Nickel Plating |
| Socket Contact | Copper Alloy Gold Over Nickel Plating |
| Hardware | 300 Series Stainless Steel |
| Encapsulant | Epoxy Resin Hysol EE4215 |

Performance Specifications

| | |
|---------------------------|-------------------------------|
| Current Rating | 3 AMP |
| DWV | 600 VAC Sea level |
| Insulation Resistance | 5000 Megohms Minimum |
| Contact Resistance | 8 Milliohms Maximum |
| Low Level Contact Resist. | 32 Milliohms Maximum |
| Magnetic Permeability | 2 μ Maximum |
| Operating Temperature | -55° C. to +150° C. |
| Shock, Vibration | 50 g., 20g. |
| Mating Force | (10 Ounces) X (# of Contacts) |

Notes:

1. Assembly to be identified with Glenair's name, part number, date code, and pin 1 identification
2. Performance data per MIL-DTL-83513
3. Interface dimensions per MIL-DTL-83513
4. PCB layout per Glenair MWDM CBR catalog data except for dimension shown. See Section C

Micro-D GRPM-CBR Right Angle Rear Panel Mount Wide Flange Printed Circuit Board Connectors



Table I: Dimensions



| Layout | A | | B ± .003 | | C Max | | D | | E Max | | F | | G Max | | H | | J | | K Max | | L Max | |
|--------|---------------|--------------|---------------|--------------|-------|-------|---------------|--------------|-------|------|---------------|--------------|-------|-------|---------------|--------------|---------------|--------------|-------|-------|-------|-------|
| | in. ± .005 | mm. ± .13 | in. ± .003 | mm. ± .08 | in. | mm. | in. ± .005 | mm. ± .13 | in. | mm. | in. ± .003 | mm. ± .08 | in. | mm. | in. ± .010 | mm. ± .25 | in. ± .010 | mm. ± .25 | in. | mm. | in. | mm. |
| 9P | .960 | 24.38 | .565 | 14.35 | .334 | 8.48 | .480 | 12.19 | .184 | 4.67 | .183 | 4.65 | .625 | 15.88 | .421 | 10.69 | .441 | 11.20 | .787 | 19.99 | .310 | 7.87 |
| 9S | .960 | 24.38 | .565 | 14.35 | .400 | 10.16 | .480 | 12.19 | .250 | 6.35 | .195 | 4.95 | .625 | 15.88 | .421 | 10.69 | .441 | 11.20 | .787 | 19.99 | .310 | 7.87 |
| 15P | 1.110 | 28.19 | .715 | 18.16 | .484 | 12.29 | .480 | 12.19 | .184 | 4.67 | .183 | 4.65 | .625 | 15.88 | .321 | 8.15 | .441 | 11.20 | .937 | 23.80 | .310 | 7.87 |
| 15S | 1.110 | 28.19 | .715 | 18.16 | .550 | 13.97 | .480 | 12.19 | .250 | 6.35 | .195 | 4.95 | .625 | 15.88 | .321 | 8.15 | .441 | 11.20 | .937 | 23.80 | .310 | 7.87 |
| 21P | 1.260 | 32.00 | .865 | 21.97 | .634 | 16.10 | .480 | 12.19 | .184 | 4.67 | .183 | 4.65 | .625 | 15.88 | .321 | 8.15 | .441 | 11.20 | 1.087 | 27.61 | .310 | 7.87 |
| 21S | 1.260 | 32.00 | .865 | 21.97 | .700 | 17.78 | .480 | 12.19 | .250 | 6.35 | .195 | 4.95 | .625 | 15.88 | .321 | 8.15 | .441 | 11.20 | 1.087 | 27.61 | .310 | 7.87 |
| 25P | 1.360 | 34.54 | .965 | 24.51 | .734 | 18.64 | .480 | 12.19 | .184 | 4.67 | .183 | 4.65 | .625 | 15.88 | .321 | 8.15 | .441 | 11.20 | 1.187 | 30.15 | .310 | 7.87 |
| 25S | 1.360 | 34.54 | .965 | 24.51 | .800 | 20.32 | .480 | 12.19 | .250 | 6.35 | .195 | 4.95 | .625 | 15.88 | .321 | 8.15 | .441 | 11.20 | 1.187 | 30.15 | .310 | 7.87 |
| 31P | 1.510 | 38.35 | 1.115 | 28.32 | .884 | 22.45 | .480 | 12.19 | .184 | 4.67 | .183 | 4.65 | .725 | 18.42 | .321 | 8.15 | .441 | 11.20 | 1.337 | 33.96 | .310 | 7.87 |
| 31S | 1.510 | 38.35 | 1.115 | 28.32 | .950 | 24.13 | .480 | 12.19 | .250 | 6.35 | .195 | 4.95 | .725 | 18.42 | .321 | 8.15 | .441 | 11.20 | 1.337 | 33.96 | .310 | 7.87 |
| 37P | 1.660 | 42.16 | 1.265 | 32.13 | 1.034 | 26.26 | .480 | 12.19 | .184 | 4.67 | .183 | 4.65 | .725 | 18.42 | .321 | 8.15 | .441 | 11.20 | 1.487 | 37.77 | .310 | 7.87 |
| 37S | 1.660 | 42.16 | 1.265 | 32.13 | 1.100 | 27.94 | .480 | 12.19 | .250 | 6.35 | .195 | 4.95 | .725 | 18.42 | .321 | 8.15 | .441 | 11.20 | 1.487 | 37.77 | .310 | 7.87 |
| 51-2P | 2.010 | 51.05 | 1.615 | 41.02 | 1.384 | 35.15 | .480 | 12.19 | .184 | 4.67 | .183 | 4.65 | .725 | 18.42 | .321 | 8.15 | .441 | 11.20 | 1.837 | 46.66 | .310 | 7.87 |
| 51-2S | 2.010 | 51.05 | 1.615 | 41.02 | 1.450 | 36.83 | .480 | 12.19 | .250 | 6.35 | .195 | 4.95 | .725 | 18.42 | .321 | 8.15 | .441 | 11.20 | 1.837 | 46.66 | .310 | 7.87 |
| 51P | 1.660 | 42.16 | 1.215 | 30.86 | 0.984 | 24.99 | .525 | 13.34 | .224 | 5.69 | .183 | 4.65 | .860 | 21.84 | .341 | 8.66 | .491 | 12.47 | 1.435 | 36.45 | .351 | 8.92 |
| 51S | 1.660 | 42.16 | 1.215 | 30.86 | 1.050 | 26.67 | .525 | 13.34 | .293 | 7.44 | .195 | 4.95 | .860 | 21.84 | .341 | 8.66 | .491 | 12.47 | 1.435 | 36.45 | .351 | 8.92 |
| 69P | 1.960 | 49.78 | 1.515 | 38.48 | 1.284 | 32.61 | .525 | 13.34 | .224 | 5.69 | .183 | 4.65 | .860 | 21.84 | .341 | 8.66 | .491 | 12.47 | 1.740 | 44.20 | .351 | 8.92 |
| 69S | 1.960 | 49.78 | 1.515 | 38.48 | 1.350 | 34.29 | .525 | 13.34 | .293 | 7.44 | .195 | 4.95 | .860 | 21.84 | .341 | 8.66 | .491 | 12.47 | 1.740 | 44.20 | .351 | 8.92 |
| 75P | 2.150 | 54.61 | 1.705 | 43.31 | 1.384 | 35.15 | .525 | 13.34 | .224 | 5.69 | .183 | 4.65 | .920 | 23.37 | .391 | 9.93 | .591 | 15.01 | 2.090 | 53.09 | .351 | 8.92 |
| 75S | 2.150 | 54.61 | 1.705 | 43.31 | 1.450 | 36.83 | .525 | 13.34 | .293 | 7.44 | .195 | 4.95 | .920 | 23.37 | .391 | 9.93 | .591 | 15.01 | 2.090 | 53.09 | .351 | 8.92 |
| 100P | 2.385 | 60.58 | 1.800 | 45.72 | 1.384 | 35.15 | .600 | 15.24 | .270 | 6.86 | .183 | 4.65 | 1.210 | 30.73 | .391 | 9.93 | .591 | 15.01 | 2.175 | 55.25 | .394 | 10.01 |
| 100S | 2.385 | 60.58 | 1.800 | 45.72 | 1.451 | 36.86 | .600 | 15.24 | .333 | 8.46 | .195 | 4.95 | 1.210 | 30.73 | .391 | 9.93 | .591 | 15.01 | 2.175 | 55.25 | .394 | 10.01 |
| 130P | 2.735 | 69.47 | 2.150 | 54.61 | 1.735 | 44.07 | .600 | 15.24 | .270 | 6.86 | .183 | 4.65 | 1.210 | 30.73 | .391 | 9.93 | .591 | 15.01 | 2.520 | 64.01 | .394 | 10.01 |
| 130S | 2.735 | 69.47 | 2.150 | 54.61 | 1.795 | 45.60 | .600 | 15.24 | .333 | 8.46 | .195 | 4.95 | 1.210 | 30.73 | .391 | 9.93 | .591 | 15.01 | 2.520 | 64.01 | .394 | 10.01 |



Micro-D MWDM-BS Vertical Mount Thru-Hole Printed Circuit Board Connectors



High Performance – These connectors feature gold-plated TwistPin contacts for best performance. PC tails are .020 inch diameter. Specify nickel-plated shells or cadmium plated shells for best availability.

Solder-Dipped – Terminals are coated with Sn60/Pb40 tin-lead solder for best solderability. Optional gold-plated terminals are available for RoHS compliance.

Rear Mountable – Can be installed through panels up to .125 inch thick. Specify rear panel mount jackposts.

How To Order BS Vertical Style PCB Micro-D Connectors

| Sample Part Number | MWDM | 1 | L | -15 | P | BS | R3 | T | -.110 | 513 |
|--------------------------------------|--|---|-----------------------|-----|-----------------------------------|----|------------------|---|------------------|-----|
| Series | MWDM Glenair Micro-D | | | | | | | | | |
| Shell Material and Finish | Aluminum Shell | | Stainless Steel Shell | | | | | | | |
| | 1 - Cadmium | | 2 - Nickel | | 3 - Passivated | | | | | |
| | 4 - Black Anodize | | | | | | | | | |
| | 5 - Gold 6 - Chem Film | | | | | | | | | |
| Insulator Material | L - LCP or PPS | | | | | | | | | |
| | LCP - 30% Glass-filled liquid crystal polymer | | | | | | | | | |
| | PPS - 40% Glass-filled polyphenylene sulfide | | | | | | | | | |
| Contact Layout | 9, 15, 21, 25, 31, 37, 51, 100 (See Table II) | | | | | | | | | |
| Contact Type | P - Pin S - Socket | | | | | | | | | |
| Termination Type | BS - Board Straight | | | | | | | | | |
| Jackpost Option | Omit - None | | P - Jackpost | | Jackposts for Rear Panel Mounting | | | | | |
| | (See Table I) | | | | R1 - .032" Panel | | R2 - .047" Panel | | R3 - .062" Panel | |
| | | | | | R4 - .093" Panel | | R5 - .125" Panel | | R6 - .080" Panel | |
| Threaded Insert Option | T - Threaded Insert In Board Mount Hole Omit - for Thru-Hole | | | | | | | | | |
| Terminal Length in Inches | .080, .110, .125, .140, .150, .172, .190, .250 Length in Inches \pm .015 (0.38) (See Table II) | | | | | | | | | |
| Gold-Plated Terminal Mod Code | These connectors are solder-dipped in 60/40 tin-lead solder. To delete the solder dip and change to gold-plated terminals, add code 513 | | | | | | | | | |

Table I: Jackpost Options

| No Designator | P | R1 Thru R6 |
|--|--|--|
| <p>THREADED INSERT</p> | | <p>Panel</p> |
| <p>Thru-Hole</p> <p>For use with Glenair jackposts only. Order hardware separately. Install with threadlocking compound.</p> | <p>Standard Jackpost</p> <p>Factory installed, not intended for removal.</p> | <p>Jackpost for Rear Panel Mounting</p> <p>Shipped loosely installed. Install with permanent threadlocking compound.</p> |

Micro-D MWDM-BS Vertical Mount Thru-Hole Printed Circuit Board Connectors



Table II: Dimensions

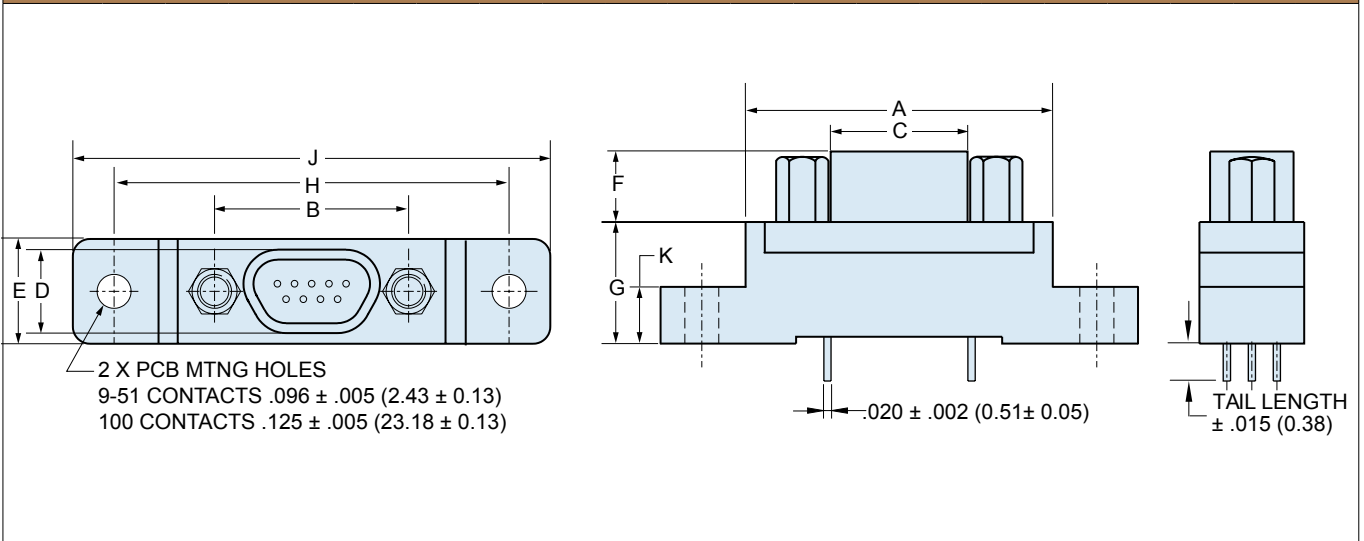

| Layout | A Max. | | B | | C Max. | | D Max. | | E Max. | | F | | G | | H | | J Max. | | K | |
|--------|--------|-------|--------------|---------------|--------|-------|--------|------|--------|-------|--------------|--------------|--------------|--------------|--------------|--------------|--------|-------|--------------|--------------|
| | In. | mm. | In. ±.003 | mm. ± 0.08 | In. | mm. | In. | mm. | In. | mm. | In. ±.004 | mm. ±0.10 | In. ±.010 | mm. ±0.25 | In. ±.007 | mm. ±0.18 | In. | mm. | In. ±.010 | mm. ±0.25 |
| 9P | .790 | 20.07 | .565 | 14.35 | .333 | 8.46 | .184 | 4.67 | .310 | 7.87 | .183 | 4.65 | .333 | 8.46 | 1.150 | 29.21 | 1.390 | 35.31 | .155 | 3.94 |
| 9S | .790 | 20.07 | .565 | 14.35 | .400 | 10.16 | .250 | 6.35 | .310 | 7.87 | .195 | 4.95 | .333 | 8.46 | 1.150 | 29.21 | 1.390 | 35.31 | .155 | 3.94 |
| 15P | .940 | 23.88 | .715 | 18.16 | .483 | 12.27 | .184 | 4.67 | .310 | 7.87 | .183 | 4.65 | .333 | 8.46 | 1.150 | 29.21 | 1.390 | 35.31 | .155 | 3.94 |
| 15S | .940 | 23.88 | .715 | 18.16 | .551 | 14.00 | .250 | 6.35 | .310 | 7.87 | .195 | 4.95 | .333 | 8.46 | 1.150 | 29.21 | 1.390 | 35.31 | .155 | 3.94 |
| 21P | 1.180 | 29.97 | .865 | 21.97 | .633 | 16.08 | .184 | 4.67 | .310 | 7.87 | .183 | 4.65 | .333 | 8.46 | 1.450 | 36.83 | 1.690 | 42.93 | .155 | 3.94 |
| 21S | 1.180 | 29.97 | .865 | 21.97 | .701 | 17.81 | .250 | 6.35 | .310 | 7.87 | .195 | 4.95 | .333 | 8.46 | 1.450 | 36.83 | 1.690 | 42.93 | .155 | 3.94 |
| 25P | 1.275 | 32.39 | .965 | 24.51 | .733 | 18.62 | .184 | 4.67 | .310 | 7.87 | .183 | 4.65 | .333 | 8.46 | 1.500 | 38.10 | 1.740 | 44.20 | .155 | 3.94 |
| 25S | 1.275 | 32.39 | .965 | 24.51 | .801 | 20.35 | .250 | 6.35 | .310 | 7.87 | .195 | 4.95 | .333 | 8.46 | 1.500 | 38.10 | 1.740 | 44.20 | .155 | 3.94 |
| 31P | 1.575 | 40.01 | 1.115 | 28.32 | .883 | 22.43 | .184 | 4.67 | .310 | 7.87 | .183 | 4.65 | .333 | 8.46 | 1.800 | 45.72 | 2.040 | 51.82 | .155 | 3.94 |
| 31S | 1.575 | 40.01 | 1.115 | 28.32 | .951 | 24.16 | .250 | 6.35 | .310 | 7.87 | .195 | 4.95 | .333 | 8.46 | 1.800 | 45.72 | 2.040 | 51.82 | .155 | 3.94 |
| 37P | 1.875 | 47.63 | 1.265 | 32.13 | 1.033 | 26.24 | .184 | 4.67 | .310 | 7.87 | .183 | 4.65 | .333 | 8.46 | 2.100 | 53.34 | 2.340 | 59.44 | .155 | 3.94 |
| 37S | 1.875 | 47.63 | 1.265 | 32.13 | 1.101 | 27.96 | .250 | 6.35 | .310 | 7.87 | .195 | 4.95 | .333 | 8.46 | 2.100 | 53.34 | 2.340 | 59.44 | .155 | 3.94 |
| 51P | 1.775 | 45.09 | 1.215 | 30.86 | .983 | 24.97 | .228 | 5.79 | .351 | 8.92 | .183 | 4.65 | .333 | 8.46 | 2.000 | 50.80 | 2.270 | 57.64 | .155 | 3.94 |
| 51S | 1.775 | 45.09 | 1.215 | 30.86 | 1.051 | 26.70 | .296 | 7.52 | .351 | 8.92 | .195 | 4.95 | .333 | 8.46 | 2.000 | 50.80 | 2.270 | 57.64 | .155 | 3.94 |
| 100P | 2.585 | 65.66 | 1.800 | 45.72 | 1.383 | 35.13 | .270 | 6.86 | .460 | 11.68 | .183 | 4.65 | .525 | 13.34 | 2.800 | 71.12 | 3.250 | 82.55 | .293 | 7.44 |
| 100S | 2.585 | 65.66 | 1.800 | 45.72 | 1.451 | 36.86 | .333 | 8.46 | .460 | 11.68 | .195 | 4.95 | .525 | 13.34 | 2.800 | 71.12 | 3.250 | 82.55 | .293 | 7.44 |

| Performance Specifications | |
|----------------------------|-------------------------------|
| Current Rating | 3 AMP |
| DWV | 600 VAC Sea level |
| Insulation Resistance | 5000 Megohms Minimum |
| Contact Resistance | 8 Milliohms Maximum |
| Low Level Contact Resist. | 32 Milliohms Maximum |
| Magnetic Permeability | 2 μ Maximum |
| Operating Temperature | -55° C. to +150° C. |
| Shock, Vibration | 50 g., 20g. |
| Mating Force | (10 Ounces) X (# of Contacts) |

| Materials and Finishes | |
|------------------------|---|
| Connector Shell | Aluminum Alloy 6061 or Stainless Steel, 300 Series, passivated. See Ordering Info for Plating Options |
| Insulator, Tray | Liquid Crystal Polymer (LCP)/ Polyphenylene Sulfide (PPS) |
| Interfacial Seal | Fluorosilicone Rubber, Blue |
| Pin Contact | Copper Alloy, Gold over Nickel Plating |
| Socket Contact | Copper Alloy, Gold Over Nickel Plating |
| PCB Terminals | Gold Plated Copper Alloy, Solder Dipped |
| Hardware | 300 Series Stainless Steel |
| Encapsulant | Epoxy Resin Hysol EE4215 |



Micro-D MWDM-BS Vertical Mount Thru-Hole Printed Circuit Board Connectors

MICRO-D BS Board Mount Connector PCB Layouts – Pin Connectors

Patterns shown are for connector mounting side of PC board. 9 Thru 51 Contacts .096 (2.44) Diameter Mounting Holes, 100 Pin .125 (3.18) Diameter



9 PIN

51 PIN



15 PIN

31 PIN



21 PIN

25 PIN

Connector Orientation



37 PIN



100 PIN

MICRO-D BS Board Mount Connector PCB Layouts – Socket Connectors

Patterns shown are for connector mounting side of PC board. 9 Thru 51 Contacts .096 (2.44) Diameter Mounting Holes, 100 Pin .125 (3.18) Diameter



9 SOCKET



51 SOCKET



15 SOCKET



31 SOCKET



21 SOCKET



25 SOCKET

Connector Orientation



37 SOCKET



100 SOCKET





Micro-D MWDM-BR Right Angle Thru-Hole Printed Circuit Board Connectors



High Performance – These connectors feature gold-plated TwistPin contacts for best performance. PC tails are .020 inch diameter. Specify nickel-plated shells or cadmium plated shells for best availability.

Solder-Dipped – Terminals are coated with Sn60/Pb40 tin-lead solder for best solderability. Optional gold-plated terminals are available for RoHS compliance.

Rear Mountable – Can be installed through panels up to .125 inch thick. Specify rear panel mount jackposts.

How To Order Micro-D BR Style Board Mount Connectors

| Sample Part Number | MWDM | 2 | L | -15 | P | BR | R3 | T | -.110 | 513 |
|--------------------------------------|--|---|-----------------------|-----|-----------------------------------|----|------------------|---|------------------|-----|
| Series | MWDM Glenair Micro-D | | | | | | | | | |
| Shell Material and Finish | Aluminum Shell | | Stainless Steel Shell | | | | | | | |
| | 1 - Cadmium | | 2 - Nickel | | 3 - Passivated | | | | | |
| | 4 - Black Anodize | | | | | | | | | |
| | 5 - Gold 6 - Chem Film | | | | | | | | | |
| Insulator Material | L - LCP or PPS | | | | | | | | | |
| | LCP - 30% Glass-filled liquid crystal polymer | | | | | | | | | |
| | PPS - 40% Glass-filled polyphenylene sulfide | | | | | | | | | |
| Contact Layout | 9, 15, 21, 25, 31, 37, 51, 100 (See Table II) | | | | | | | | | |
| Contact Type | P - Pin S - Socket | | | | | | | | | |
| Termination Type | BR - Board Right Angle | | | | | | | | | |
| Jackpost Option | Omit for None | | P - Jackpost | | Jackposts for Rear Panel Mounting | | | | | |
| | (See Table I) | | | | R1 - .032" Panel | | R2 - .047" Panel | | R3 - .062" Panel | |
| | | | | | R4 - .093" Panel | | R5 - .125" Panel | | R6 - .080" Panel | |
| Threaded Insert Option | T - Threaded Insert In Board Mount Hole Omit - for Thru-Hole | | | | | | | | | |
| Terminal Length (Inches) | .080, .110, .125, .140, .150, .172, .190, .250 Length in Inches ± .015 (0.38) (See Table II) | | | | | | | | | |
| Gold-Plated Terminal Mod Code | These connectors are solder-dipped in 60/40 tin-lead solder. To delete the solder dip and change to gold-plated terminals, add code 513 | | | | | | | | | |

Table I: Jackpost Options

| No Designator | P | R1 Thru R6 |
|--|--|--|
| <p>THREADED INSERT</p> | | <p>Panel</p> |
| <p>Thru-Hole For use with Glenair jackposts only. Order hardware separately. Install with threadlocking compound.</p> | <p>Standard Jackpost Factory installed, not intended for removal.</p> | <p>Jackpost for Rear Panel Mounting Shipped loosely installed. Install with permanent threadlocking compound.</p> |

Micro-D MWDM-BR Right Angle Thru-Hole Printed Circuit Board Connectors



Micro-D PCB

Table II: Dimensions



| Layout | A Max. | | B | | C Max. | | D Max. | | E Max. | | F | | G Max. | | H | | J | | K | |
|--------|--------|-------|-------|-------|--------|-------|--------|------|--------|-------|-------|-------|--------|-------|------|------|------|------|------|------|
| | In. | mm. | In. | mm. | In. | mm. | In. | mm. | In. | mm. | In. | mm. | In. | mm. | In. | mm. | In. | mm. | In. | mm. |
| 9P | 1.390 | 35.31 | .565 | 14.35 | .333 | 8.46 | .184 | 4.67 | .310 | 7.87 | 1.150 | 29.21 | .465 | 11.81 | .183 | 4.65 | .125 | 3.18 | .150 | 3.81 |
| 9S | 1.390 | 35.31 | .565 | 14.35 | .400 | 10.16 | .250 | 6.35 | .310 | 7.87 | 1.150 | 29.21 | .465 | 11.81 | .195 | 4.95 | .125 | 3.18 | .150 | 3.81 |
| 15P | 1.540 | 39.12 | .715 | 18.16 | .483 | 12.27 | .184 | 4.67 | .310 | 7.87 | 1.300 | 33.02 | .465 | 11.81 | .183 | 4.65 | .125 | 3.18 | .150 | 3.81 |
| 15S | 1.540 | 39.12 | .715 | 18.16 | .551 | 14.00 | .250 | 6.35 | .310 | 7.87 | 1.300 | 33.02 | .465 | 11.81 | .195 | 4.95 | .125 | 3.18 | .150 | 3.81 |
| 21P | 1.690 | 42.93 | .865 | 21.97 | .633 | 16.08 | .184 | 4.67 | .310 | 7.87 | 1.450 | 36.83 | .465 | 11.81 | .183 | 4.65 | .125 | 3.18 | .150 | 3.81 |
| 21S | 1.690 | 42.93 | .865 | 21.97 | .701 | 17.81 | .250 | 6.35 | .310 | 7.87 | 1.450 | 36.83 | .465 | 11.81 | .195 | 4.95 | .125 | 3.18 | .150 | 3.81 |
| 25P | 1.790 | 45.47 | .965 | 24.51 | .733 | 18.62 | .184 | 4.67 | .310 | 7.87 | 1.550 | 39.37 | .465 | 11.81 | .183 | 4.65 | .125 | 3.18 | .150 | 3.81 |
| 25S | 1.790 | 45.47 | .965 | 24.51 | .801 | 20.35 | .250 | 6.35 | .310 | 7.87 | 1.550 | 39.37 | .465 | 11.81 | .195 | 4.95 | .125 | 3.18 | .150 | 3.81 |
| 31P | 2.040 | 51.82 | 1.115 | 28.32 | .883 | 22.43 | .184 | 4.67 | .310 | 7.87 | 1.800 | 45.72 | .465 | 11.81 | .183 | 4.65 | .125 | 3.18 | .150 | 3.81 |
| 31S | 2.040 | 51.82 | 1.115 | 28.32 | .951 | 24.16 | .250 | 6.35 | .310 | 7.87 | 1.800 | 45.72 | .465 | 11.81 | .195 | 4.95 | .125 | 3.18 | .150 | 3.81 |
| 37P | 2.340 | 59.44 | 1.265 | 32.13 | 1.033 | 26.24 | .184 | 4.67 | .310 | 7.87 | 2.100 | 53.34 | .465 | 11.81 | .183 | 4.65 | .125 | 3.18 | .150 | 3.81 |
| 37S | 2.340 | 59.44 | 1.265 | 32.13 | 1.101 | 27.96 | .250 | 6.35 | .310 | 7.87 | 2.100 | 53.34 | .465 | 11.81 | .195 | 4.95 | .125 | 3.18 | .150 | 3.81 |
| 51P | 1.875 | 47.63 | 1.215 | 30.86 | .983 | 24.97 | .228 | 5.79 | .351 | 8.92 | 1.600 | 40.64 | .565 | 14.35 | .183 | 4.65 | .125 | 3.18 | .150 | 3.81 |
| 51S | 1.875 | 47.63 | 1.215 | 30.86 | 1.051 | 26.70 | .296 | 7.52 | .351 | 8.92 | 1.600 | 40.64 | .565 | 14.35 | .195 | 4.95 | .125 | 3.18 | .150 | 3.81 |
| 100P | 2.780 | 70.60 | 1.800 | 45.72 | 1.383 | 35.13 | .270 | 6.86 | .394 | 10.01 | 2.500 | 63.50 | .765 | 19.43 | .183 | 4.65 | .225 | 5.72 | .150 | 3.81 |
| 100S | 2.780 | 70.60 | 1.800 | 45.72 | 1.451 | 36.86 | .333 | 8.46 | .394 | 10.01 | 2.500 | 63.50 | .765 | 19.43 | .195 | 4.95 | .225 | 5.72 | .150 | 3.81 |

| Performance Specifications | |
|----------------------------|-------------------------------|
| Current Rating | 3 AMP |
| DWV | 600 VAC Sea level |
| Insulation Resistance | 5000 Megohms Minimum |
| Contact Resistance | 8 Milliohms Maximum |
| Low Level Contact Resist. | 32 Milliohms Maximum |
| Magnetic Permeability | 2 μ Maximum |
| Operating Temperature | -55° C. to +150° C. |
| Shock, Vibration | 50 g., 20g. |
| Mating Force | (10 Ounces) X (# of Contacts) |

| Materials and Finishes | |
|------------------------|---|
| Connector Shell | Aluminum Alloy 6061 or Stainless Steel, 300 Series, passivated. See Ordering Info for Plating Options |
| Insulator, Tray | Liquid Crystal Polymer (LCP)/ Polyphenylene Sulfide (PPS) |
| Interfacial Seal | Fluorosilicone Rubber, Blue |
| Pin Contact | Copper Alloy, Gold over Nickel Plating |
| Socket Contact | Copper Alloy, Gold Over Nickel Plating |
| PCB Terminals | Gold Plated Copper Alloy, Solder Dipped |
| Hardware | 300 Series Stainless Steel |
| Encapsulant | Epoxy Resin Hysol EE4215 |



Micro-D MWDM-BR Right Angle Thru-Hole Printed Circuit Board Connectors

MICRO-D BR Board Mount Connector PCB Layouts – Pin Connectors

Patterns shown are for connector mounting side of PC board. 9 Thru 51 Contacts .096 (2.44) Diameter Mounting Holes, 100 Pin .125 (3.18) Diameter



9 PIN



51 PIN



15 PIN



31 PIN



21 PIN



25 PIN



37 PIN



100 PIN

MICRO-D BR Board Mount Connector PCB Layouts – Socket Connectors

Patterns shown are for connector mounting side of PC board. 9 Thru 51 Contacts .096 (2.44) Diameter Mounting Holes, 100 Pin .125 (3.18) Diameter



9 SOCKET



51 SOCKET



15 SOCKET



31 SOCKET



21 SOCKET



25 SOCKET



37 SOCKET



100 SOCKET



Micro-D MWDM-CBS Vertical Board Mount Printed Circuit Board Connector



High Performance – These connectors feature gold-plated TwistPin contacts for best performance. PC tails are .020 inch diameter. Specify nickel-plated shells or cadmium plated shells for best availability.

Solder-Dipped – Terminals are coated with Sn60/Pb40 tin-lead solder for best solderability. Optional gold-plated terminals are available for RoHS compliance.

Rear Mountable – Can be installed through panels up to .125 inch thick. Specify rear panel mount jackposts.

How To Order CBS Style PCB Micro-D Connectors

| Sample Part Number | MWDM | 1 | L- | 31 | P | CBS | NN | -.110 | 513 |
|-------------------------------|--|---|----|--|---|-----|--|-------|-----|
| Series | MWDM - Micro-D Metal Shell | | | | | | | | |
| Shell Material and Finish | Aluminum Shell 1 - Cadmium 2 - Nickel 4 - Black Anodize 5 - Gold 6 - Chem Film Stainless Steel Shell 3 - Passivated | | | | | | | | |
| Insulator Material | L - LCP or PPS LCP - 30% Glass-filled liquid crystal polymer PPS - 40% Glass-filled polyphenylene sulfide | | | | | | | | |
| Contact Layout | 9, 15, 21, 25, 31, 37, 51, 69, 75, 100, 130 (See Table I) | | | | | | | | |
| Contact Type | P - Pin S - Socket | | | | | | | | |
| Termination Type | CBS - Condensed Board Straight | | | | | | | | |
| Hardware Option | NN – No Jackpost, No Threaded Insert PN – Extended Jackpost for .062" (1.6) PCB, No Threaded Insert RN – Extended Jackpost for .196" (5.0) PCB, No Threaded Insert NU – Threaded Insert Only, No Jackposts PU – Short Jackpost and Threaded Insert | | | Rear Panel Jackposts With Threaded Inserts R7U – .080" (2.0) Panel R6U – .125" (3.2) Panel R5U – .094" (2.4) Panel R4U – .062" (1.6) Panel R3U – .047" (1.2) Panel R2U – .031" (0.8) Panel | | | Jackscrew Options M – Hex Head Jackscrews S – Slot Head Jackscrews | | |
| PC Tail Length | .080, .110, .140, .172, .190, .250 Length in Inches ± .015 (0.38) | | | | | | | | |
| Gold-Plated Terminal Mod Code | These connectors are solder-dipped in 60/40 tin-lead solder. To delete the solder dip and change to gold-plated terminals, add code 513 | | | | | | | | |

HARDWARE OPTIONS

See Pages C-22 and C-23

Micro-D MWDM-CBS
Vertical Board Mount
Printed Circuit Board Connector



Table I: Dimensions



| Layout | A Max. | | B | | C Max. | | D Max. | | E Max. | | F | | G Max. | |
|--------|--------|-------|---------------|---------------|--------|-------|--------|------|--------|-------|---------------|---------------|--------|-------|
| | In. | mm. | In. ± .005 | mm. ± 0.13 | In. | mm. | In. | mm. | In. | mm. | In. ± .003 | mm. ± 0.08 | In. | mm. |
| 9P | .785 | 19.94 | .565 | 14.35 | .333 | 8.46 | .184 | 4.67 | .310 | 7.87 | .183 | 4.65 | .355 | 9.02 |
| 9S | .785 | 19.94 | .565 | 14.35 | .400 | 10.16 | .250 | 6.35 | .310 | 7.87 | .195 | 4.95 | .355 | 9.02 |
| 15P | .935 | 23.75 | .715 | 18.16 | .483 | 12.27 | .184 | 4.67 | .310 | 7.87 | .183 | 4.65 | .355 | 9.02 |
| 15S | .935 | 23.75 | .715 | 18.16 | .551 | 14.00 | .250 | 6.35 | .310 | 7.87 | .195 | 4.95 | .355 | 9.02 |
| 21P | 1.085 | 27.56 | .865 | 21.97 | .633 | 16.08 | .184 | 4.67 | .310 | 7.87 | .183 | 4.65 | .355 | 9.02 |
| 21S | 1.085 | 27.56 | .865 | 21.97 | .701 | 17.81 | .250 | 6.35 | .310 | 7.87 | .195 | 4.95 | .355 | 9.02 |
| 25P | 1.185 | 30.01 | .965 | 24.51 | .733 | 18.62 | .184 | 4.67 | .310 | 7.87 | .183 | 4.65 | .355 | 9.02 |
| 25S | 1.185 | 30.01 | .965 | 24.51 | .801 | 20.35 | .250 | 6.35 | .310 | 7.87 | .195 | 4.95 | .355 | 9.02 |
| 31P | 1.335 | 33.91 | 1.115 | 28.32 | .883 | 22.43 | .184 | 4.67 | .310 | 7.87 | .183 | 4.65 | .355 | 9.02 |
| 31S | 1.335 | 33.91 | 1.115 | 28.32 | .951 | 24.16 | .250 | 6.35 | .310 | 7.87 | .195 | 4.95 | .355 | 9.02 |
| 37P | 1.485 | 37.72 | 1.265 | 32.13 | 1.033 | 26.24 | .184 | 4.67 | .310 | 7.87 | .183 | 4.65 | .355 | 9.02 |
| 37S | 1.485 | 37.72 | 1.265 | 32.13 | 1.101 | 27.96 | .250 | 6.35 | .310 | 7.87 | .195 | 4.95 | .355 | 9.02 |
| 51P | 1.435 | 36.45 | 1.215 | 30.86 | .983 | 24.97 | .228 | 5.79 | .400 | 10.16 | .183 | 4.65 | .355 | 9.02 |
| 51S | 1.435 | 36.45 | 1.215 | 30.86 | 1.051 | 26.70 | .296 | 7.52 | .400 | 10.16 | .195 | 4.95 | .355 | 9.02 |
| 69P | 1.735 | 44.07 | 1.515 | 38.48 | 1.284 | 32.61 | .224 | 5.69 | .400 | 10.16 | .183 | 4.65 | .355 | 9.02 |
| 69S | 1.735 | 44.07 | 1.515 | 38.48 | 1.50 | 34.29 | .293 | 7.44 | .400 | 10.16 | .195 | 4.95 | .355 | 9.02 |
| 75P | 2.080 | 52.83 | 1.705 | 43.31 | 1.384 | 35.15 | .228 | 5.79 | .400 | 10.16 | .183 | 4.65 | .355 | 9.02 |
| 75S | 2.080 | 52.83 | 1.705 | 43.31 | 1.450 | 36.83 | .296 | 7.52 | .400 | 10.16 | .195 | 4.95 | .355 | 9.02 |
| 100P | 2.170 | 55.12 | 1.800 | 45.72 | 1.383 | 35.13 | .270 | 6.86 | .510 | 12.95 | .183 | 4.65 | .430 | 10.92 |
| 100S | 2.170 | 55.12 | 1.800 | 45.72 | 1.451 | 36.86 | .333 | 8.46 | .510 | 12.95 | .195 | 4.95 | .430 | 10.92 |
| 130P | 2.520 | 64.00 | 2.150 | 54.61 | 1.735 | 44.07 | .270 | 6.86 | .510 | 12.95 | .183 | 4.65 | .430 | 10.92 |
| 130S | 2.520 | 64.00 | 2.150 | 54.61 | 1.795 | 45.59 | .333 | 8.46 | .510 | 12.95 | .195 | 4.95 | .430 | 10.92 |

| Performance Specifications | |
|----------------------------|-------------------------------|
| Current Rating | 3 AMP |
| DWV | 600 VAC Sea level |
| Insulation Resistance | 5000 Megohms Minimum |
| Contact Resistance | 8 Milliohms Maximum |
| Low Level Contact Resist. | 32 Milliohms Maximum |
| Magnetic Permeability | 2 μ Maximum |
| Operating Temperature | -55° C. to +150° C. |
| Shock, Vibration | 50 g., 20g. |
| Mating Force | (10 Ounces) X (# of Contacts) |

| Materials and Finishes | |
|------------------------|---|
| Connector Shell | Aluminum Alloy 6061 or Stainless Steel, 300 Series, passivated. See Ordering Info for Plating Options |
| Insulator, Tray | Liquid Crystal Polymer (LCP) Polyphenylene Sulfide (PPS) |
| Interfacial Seal | Fluorosilicone Rubber, Blue |
| Pin Contact | Copper Alloy, Gold over Nickel Plating |
| Socket Contact | Copper Alloy, Gold Over Nickel Plating |
| PCB Terminals | Gold Plated Copper Alloy, Solder Dipped |
| Hardware | 300 Series Stainless Steel |
| Encapsulant | Epoxy Resin Hysol EE4215 |



Micro-D MWDM-CBS Vertical Board Mount Hardware

MICRO-D CBS Board Mount Connector Hardware Options



NN Style
Thru-Hole, No Hardware

A DIAMETER
9-69 CONTACTS
.096/.088 (2.44/2.24)
75, 100, 130 CONTACTS
.150/.145 (3.81/3.68)



NU Style
Threaded Insert

9-69 CONTACTS
NO. 2-56 UNC-2B
75-130 CONTACTS
NO. 4-40 UNC-2B



.160 (4.1) MIN. (9-69 PINS)
.225 (5.7) MIN. (75 - 130 PIN)

PU Style

Jackpost with Threaded Insert

9 – 69 Contacts



Kit Part Number **500-063-1**
Kit Consists of Two Jackposts

75 – 130 Contacts



Kit Part Number **500-063-2**
Kit Consists of Two Jackposts

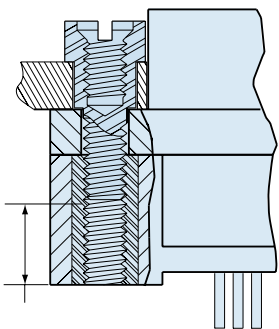

.160 (4.1) MIN. (9-69 PINS)
.225 (5.7) MIN. (75 - 130 PINS)

RU Style

Jackpost For Rear Panel Mounting,
with Threaded Insert

9 – 69 Contacts



75 – 130 Contacts



| Hardware Option | Panel Thickness | Part Number | A ± .003 (0.08) | Hardware Option | Panel Thickness | Part Number | A ± .003 (0.08) |
|-----------------|-----------------|---------------|--------------------|-----------------|-----------------|---------------|--------------------|
| R2U | 1/32 (0.8) | 177-505-A-2-2 | .024 (0.6) | R2U | 1/32 (0.8) | 177-505-D-4-2 | .024 (0.6) |
| R3U | 3/64 (1.2) | 177-505-A-2-3 | .041 (1.0) | R3U | 3/64 (1.2) | 177-505-D-4-3 | .041 (1.0) |
| R4U | 1/16 (1.6) | 177-505-A-2-4 | .055 (1.4) | R4U | 1/16 (1.6) | 177-505-D-4-4 | .055 (1.4) |
| R5U | 3/32 (2.4) | 177-505-A-2-5 | .086 (2.2) | R5U | 3/32 (2.4) | 177-505-D-4-5 | .086 (2.2) |
| R6U | 1/8 (3.2) | 177-505-A-2-6 | .118 (3.0) | R6U | 1/8 (3.2) | 177-505-D-4-6 | .118 (3.0) |
| R7U | 5/64 (2.0) | 177-505-A-2-7 | .073 (1.9) | R7U | 5/64 (2.0) | 177-505-D-4-7 | .073 (1.9) |

MICRO-D CBS Board Mount Connector Hardware Options



PN Style

for .062" PCB

RN Style for .196" PCB

Jackpost Kit

9 - 69 Contacts



PN Kit Part Number **500-069-2-6**

RN Kit Part Number **500-069-2-7**

Kit Consists of 2 Jackposts, 2 Nuts, 2 Washers

75 - 130 Contacts



PN Kit Part Number **500-069-4-7**

RN Kit Part Number **500-069-4-8**

Kit Consists of 2 Jackposts, 2 Nuts, 2 Washers

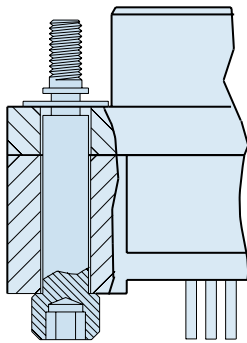

M Style

Hex Head Jackscrew with
E-Ring

9 - 69 Contacts

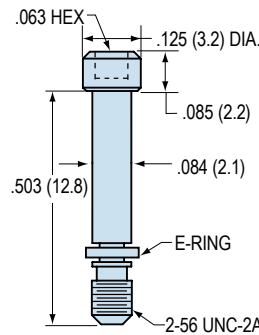

Kit Part Number **500-080-2**

Kit Consists of 2 Jackscrews and 2 E-Rings

75 - 130 Contacts

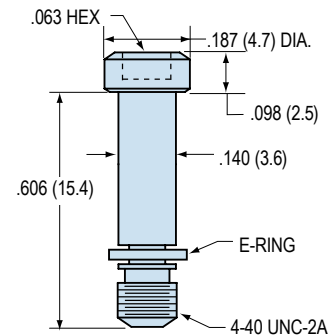

Kit Part Number **500-080-4**

Kit Consists of 2 Jackscrews and 2 E-Rings

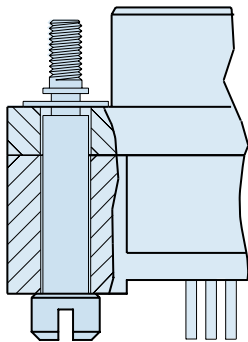

S Style

Slot Head Jackscrew with
E-Ring

9 - 69 Contacts

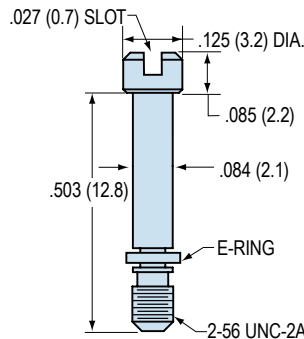

Kit Part Number **500-081-2**

Kit Consists of 2 Jackscrews and 2 E-Rings

75 - 130 Contacts

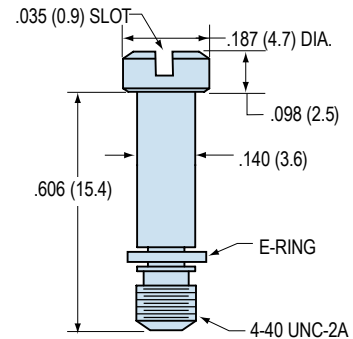

Kit Part Number **500-081-4**

Kit Consists of 2 Jackscrews and 2 E-Rings



MICRO-D CBS Board Mount Connector PCB Layouts – Pin Connectors

Patterns shown are for connector mounting side of PC board.



9 PIN



15 PIN

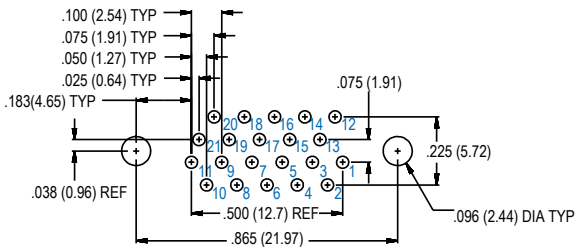

21 PIN

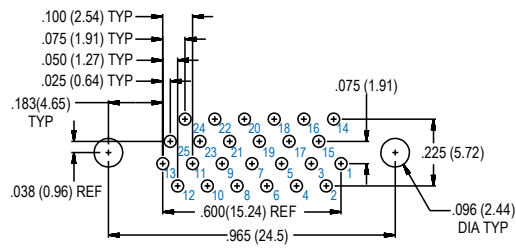

25 PIN

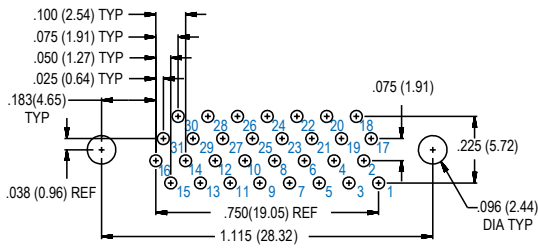

31 PIN

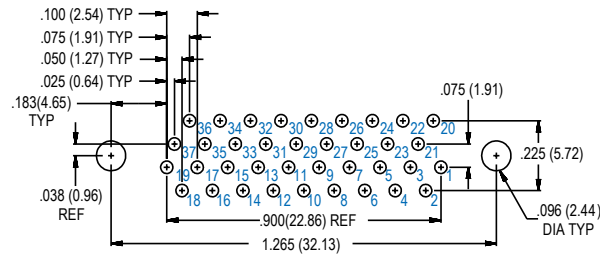

37 PIN

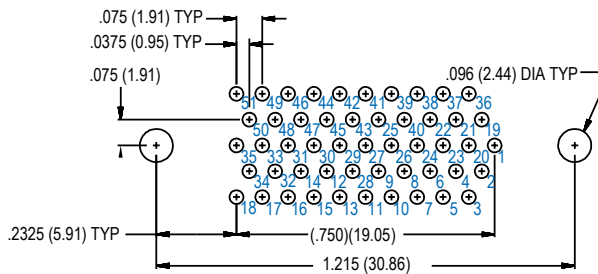

51 PIN

MICRO-D CBS Board Mount Connector PCB Layouts – Pin Connectors

Patterns shown are for connector mounting side of PC board.



69 PIN



75 PIN



100 PIN



130 PIN



Micro-D MWDM-CBS
Vertical Board Mount
PCB Layouts

MICRO-D CBS Board Mount Connector PCB Layouts – Socket Connectors

Patterns shown are for connector mounting side of PC board.



9 SOCKET



15 SOCKET



21 SOCKET



25 SOCKET



31 SOCKET



37 SOCKET



51 SOCKET

MICRO-D CBS Board Mount Connector PCB Layouts – Socket Connectors

Patterns shown are for connector mounting side of PC board.



69 SOCKET



75 SOCKET



100 SOCKET



130 SOCKET



Micro-D MWDM-CBR Right Angle Thru-Hole Printed Circuit Board Connectors



High Performance – These connectors feature gold-plated TwistPin contacts for best performance. PC tails are .020 inch diameter. Specify nickel-plated shells or cadmium plated shells for best availability.

Solder-Dipped – Terminals are coated with Sn60/Pb40 tin-lead solder for best solderability. Optional gold-plated terminals are available for RoHS compliance.

Rear Mountable – Can be installed through panels up to .125 inch thick. Specify rear panel mount jackposts.

How To Order CBR Style PCB Micro-D Connectors

| Sample Part Number | MWDM | 2 | L | -15 | P | CBR | R3 | T | -.110 | 513 |
|--------------------------------------|--|---|---|-----|---------------|-----|----|---|-------|-----|
| Series | MWDM Glenair Micro-D | | | | | | | | | |
| Shell Material and Finish | Aluminum Shell 1 - Cadmium 2 - Nickel 4 - Black Anodize 5 - Gold 6 - Chem Film | | Stainless Steel Shell 3 - Passivated | | | | | | | |
| Insulator Material | L - LCP or PPS LCP - 30% Glass-filled liquid crystal polymer PPS - 40% Glass-filled polyphenylene sulfide | | | | | | | | | |
| Contact Layout | 9, 15, 21, 25, 31, 37, 51, 69, 75, 100, 130 (See Table II) | | | | | | | | | |
| Contact Type | P – Pin S – Socket | | | | | | | | | |
| Termination Type | CBR - Condensed Board Right Angle | | | | | | | | | |
| Jackpost Option | (Omit for None) P – Jackpost | | Jackposts for Rear Panel Mounting R1 – .032" Panel R2 – .047" Panel R3 – .062" Panel R4 – .093" Panel R5 – .125" Panel R6 – .080" Panel | | (See Table I) | | | | | |
| Threaded Insert Option | T - Threaded Insert In Board Mount Hole Omit for Thru-Hole | | | | | | | | | |
| Terminal Length in Inches | .080, .110, .125, .140, .150, .172, .190, .250 Length in Inches ± .015 (0.38) | | | | | | | | | |
| Gold-Plated Terminal Mod Code | These connectors are solder-dipped in 60/40 tin-lead solder. To delete the solder dip and change to gold-plated terminals, add code 513 | | | | | | | | | |

Table I: Jackpost Options

| No Designator | P | R1 Thru R6 |
|---|---|---|
| <p>THREADED INSERT</p> | | <p>Panel</p> |
| <p>Thru-Hole For use with Glenair jackposts only. Order hardware separately. Install with threadlocking compound.</p> | <p>Standard Jackpost Factory installed, not intended for removal.</p> | <p>Jackpost for Rear Panel Mounting Shipped loosely installed. Install with permanent threadlocking compound.</p> |

Micro-D MWDM-CBR Right Angle Thru-Hole Printed Circuit Board Connectors



Micro-D PCB

Table II: Dimensions



C

| Layout | A Max. | | B | | C Max. | | D Max. | | E Max. | | F | | G Max. | | H | | J | | K Max. | | L Max. | |
|--------|--------|-------|-------|-------|--------|-------|--------|------|--------|-------|------|------|--------|-------|------|------|------|-------|--------|-------|--------|-------|
| | In. | mm. | In. | mm. | In. | mm. | In. | mm. | In. | mm. | In. | mm. | In. | mm. | In. | mm. | In. | mm. | In. | mm. | In. | mm. |
| 9P | .787 | 19.94 | .565 | 14.35 | .333 | 8.46 | .184 | 4.67 | .310 | 7.87 | .183 | 4.65 | .425 | 10.80 | .230 | 5.84 | .250 | 6.35 | --- | --- | --- | --- |
| 9S | .787 | 19.94 | .565 | 14.35 | .400 | 10.16 | .250 | 6.35 | .310 | 7.87 | .195 | 4.95 | .425 | 10.80 | .230 | 5.84 | .250 | 6.35 | --- | --- | --- | --- |
| 15P | .937 | 23.75 | .715 | 18.16 | .483 | 12.27 | .184 | 4.67 | .310 | 7.87 | .183 | 4.65 | .425 | 10.80 | .130 | 3.30 | .250 | 6.35 | --- | --- | --- | --- |
| 15S | .937 | 23.75 | .715 | 18.16 | .551 | 14.00 | .250 | 6.35 | .310 | 7.87 | .195 | 4.95 | .425 | 10.80 | .130 | 3.30 | .250 | 6.35 | --- | --- | --- | --- |
| 21P | 1.087 | 27.56 | .865 | 21.97 | .633 | 16.08 | .184 | 4.67 | .310 | 7.87 | .183 | 4.65 | .425 | 10.80 | .130 | 3.30 | .250 | 6.35 | --- | --- | --- | --- |
| 21S | 1.087 | 27.56 | .865 | 21.97 | .701 | 17.81 | .250 | 6.35 | .310 | 7.87 | .195 | 4.95 | .425 | 10.80 | .130 | 3.30 | .250 | 6.35 | --- | --- | --- | --- |
| 25P | 1.187 | 30.01 | .965 | 24.51 | .733 | 18.62 | .184 | 4.67 | .310 | 7.87 | .183 | 4.65 | .425 | 10.80 | .130 | 3.30 | .250 | 6.35 | --- | --- | --- | --- |
| 25S | 1.187 | 30.01 | .965 | 24.51 | .801 | 20.35 | .250 | 6.35 | .310 | 7.87 | .195 | 4.95 | .425 | 10.80 | .130 | 3.30 | .250 | 6.35 | --- | --- | --- | --- |
| 31P | 1.337 | 33.91 | 1.115 | 28.32 | .883 | 22.43 | .184 | 4.67 | .310 | 7.87 | .183 | 4.65 | .525 | 13.34 | .130 | 3.30 | .250 | 6.35 | .450 | 11.43 | 1.085 | 27.56 |
| 31S | 1.337 | 33.91 | 1.115 | 28.32 | .951 | 24.16 | .250 | 6.35 | .310 | 7.87 | .195 | 4.95 | .525 | 13.34 | .130 | 3.30 | .250 | 6.35 | .450 | 11.43 | 1.085 | 27.56 |
| 37P | 1.487 | 37.72 | 1.265 | 32.13 | 1.033 | 26.24 | .184 | 4.67 | .310 | 7.87 | .183 | 4.65 | .525 | 13.34 | .130 | 3.30 | .250 | 6.35 | .450 | 11.43 | 1.185 | 30.10 |
| 37S | 1.487 | 37.72 | 1.265 | 32.13 | 1.101 | 27.96 | .250 | 6.35 | .310 | 7.87 | .195 | 4.95 | .525 | 13.34 | .130 | 3.30 | .250 | 6.35 | .450 | 11.43 | 1.185 | 30.10 |
| 51P | 1.435 | 36.45 | 1.215 | 30.86 | .983 | 24.97 | .228 | 5.79 | .351 | 8.92 | .183 | 4.65 | .660 | 16.76 | .150 | 3.81 | .300 | 7.62 | .450 | 11.43 | 1.225 | 31.12 |
| 51S | 1.435 | 36.45 | 1.215 | 30.86 | 1.051 | 26.70 | .296 | 7.52 | .351 | 8.92 | .195 | 4.95 | .660 | 16.76 | .150 | 3.81 | .300 | 7.62 | .450 | 11.43 | 1.225 | 31.12 |
| 69P | 1.740 | 44.20 | 1.515 | 38.48 | 1.283 | 32.59 | .228 | 5.79 | .351 | 8.92 | .183 | 4.65 | .750 | 19.05 | .150 | 3.81 | .300 | 7.62 | .450 | 11.43 | 1.530 | 38.86 |
| 69S | 1.740 | 44.20 | 1.515 | 38.48 | 1.351 | 34.32 | .296 | 7.52 | .351 | 8.92 | .195 | 4.95 | .750 | 19.05 | .150 | 3.81 | .300 | 7.62 | .450 | 11.43 | 1.530 | 38.86 |
| 75P | 2.080 | 52.83 | 1.705 | 43.31 | 1.384 | 35.15 | .228 | 5.79 | .351 | 8.92 | .183 | 4.65 | .800 | 20.32 | .200 | 5.08 | .400 | 10.16 | .590 | 14.99 | 1.650 | 41.91 |
| 75S | 2.080 | 52.83 | 1.705 | 43.31 | 1.450 | 36.83 | .296 | 7.52 | .351 | 8.92 | .195 | 4.95 | .800 | 20.32 | .200 | 5.08 | .400 | 10.16 | .590 | 14.99 | 1.650 | 41.91 |
| 100P | 2.175 | 55.12 | 1.800 | 45.72 | 1.383 | 35.13 | .270 | 6.86 | .394 | 10.01 | .183 | 4.65 | 1.010 | 25.65 | .200 | 5.08 | .400 | 10.16 | .590 | 14.99 | 1.820 | 46.23 |
| 100S | 2.175 | 55.12 | 1.800 | 45.72 | 1.451 | 36.86 | .333 | 8.46 | .394 | 10.01 | .195 | 4.95 | 1.010 | 25.65 | .200 | 5.08 | .400 | 10.16 | .590 | 14.99 | 1.820 | 46.23 |
| 130P | 2.520 | 64.01 | 2.150 | 54.61 | 1.735 | 44.07 | .270 | 6.86 | .394 | 10.01 | .183 | 4.65 | 1.010 | 25.65 | .200 | 5.08 | .400 | 10.16 | .620 | 15.75 | 2.160 | 54.86 |
| 130S | 2.520 | 64.01 | 2.150 | 54.61 | 1.735 | 44.07 | .333 | 8.46 | .394 | 10.01 | .195 | 4.95 | 1.010 | 25.65 | .200 | 5.08 | .400 | 10.16 | .620 | 15.75 | 2.160 | 54.86 |

| Performance Specifications | |
|----------------------------|-------------------------------|
| Current Rating | 3 AMP |
| DWV | 600 VAC Sea level |
| Insulation Resistance | 5000 Megohms Minimum |
| Contact Resistance | 8 Milliohms Maximum |
| Low Level Contact Resist. | 32 Milliohms Maximum |
| Magnetic Permeability | 2 μ Maximum |
| Operating Temperature | -55° C. to +150° C. |
| Shock, Vibration | 50 g., 20g. |
| Mating Force | (10 Ounces) X (# of Contacts) |

| Materials and Finishes | |
|------------------------|---|
| Connector Shell | Aluminum Alloy 6061 or Stainless Steel, 300 Series, passivated. See Ordering Info for Plating Options |
| Insulator, Tray | Liquid Crystal Polymer (LCP)/ Polyphenylene Sulfide (PPS) |
| Interfacial Seal | Fluorosilicone Rubber, Blue |
| Pin Contact | Copper Alloy, Gold over Nickel Plating |
| Socket Contact | Copper Alloy, Gold Over Nickel Plating |
| PCB Terminals | Gold Plated Copper Alloy, Solder Dipped |
| Hardware | 300 Series Stainless Steel |
| Encapsulant | Epoxy Resin Hysol EE4215 |

© 2013 Glenair, Inc. High Performance Micro-D Connectors and Cables U.S. CAGE Code 06324 Printed in U.S.A.

GLENAIR, INC. • 1211 AIR WAY • GLENDALE, CA 91201-2497 • 818-247-6000 • FAX 818-500-9912

www.glenair.com

C-23

E-Mail: sales@glenair.com



Micro-D MWDM-CBR Right Angle Thru-Hole Printed Circuit Board Connectors

MICRO-D CBR Board Mount Connector PCB Layouts – Pin Connectors

Patterns shown are for connector mounting side of PC board. 9 Thru 69 Contacts .096 (2.44) Diameter Mounting Holes, 75-130 Pin .125 (3.18) Diameter



9 PIN



15 PIN



21 PIN



25 PIN



31 PIN



37 PIN



51 PIN



69 PIN

MICRO-D CBR Board Mount Connector PCB Layouts – Pin Connectors

Patterns shown are for connector mounting side of PC board. 9 Thru 69 Contacts .096 (2.44) Diameter Mounting Holes, 75-130 Pin .125 (3.18) Diameter



75 PIN



100 PIN



130 PIN



Micro-D MWDM-CBR Right Angle Thru-Hole Printed Circuit Board Connectors

MICRO-D CBR Board Mount Connector PCB Layouts – Socket Connectors

Patterns shown are for connector mounting side of PC board. 9 Thru 69 Contacts .096 (2.44) Diameter Mounting Holes, 75-130 Pin .125 (3.18) Diameter



9 SOCKET



15 SOCKET



21 SOCKET



25 SOCKET



31 SOCKET



37 SOCKET



51 SOCKET



69 SOCKET

Micro-D MWDM-CBR
Right Angle Thru-Hole
Printed Circuit Board Connectors



MICRO-D CBR Board Mount Connector PCB Layouts – Socket Connectors

Patterns shown are for connector mounting side of PC board. 9 Thru 69 Contacts .096 (2.44) Diameter Mounting Holes, 75-130 Pin .125 (3.18) Diameter



75 SOCKET



100 SOCKET



130 SOCKET



Micro-D MWDM-SMR Surface Mount Right Angle Printed Circuit Board Connectors



Surface Mount Micro-D – These connectors feature .025 inch terminal spacing and an alignment strip for accurate registration. The integral mounting legs provide a ground path.

9 To 51 Contacts – These compact connectors are lighter and smaller than comparable thru-hole versions.

Mil Spec Reliability – Suitable for mission-critical requirements, These high performance connectors meet the requirements of MIL-DTL-83513.



Pin Connector



Socket Connector

How To Order Surface Mount PCB Micro-D Connectors

| Sample Part Number | MWDM | 2 | L | 51-2 | P | SMR | P | N |
|---------------------------------------|--|---|---|------|---|-----|---|---|
| Series | MWDM Glenair Micro-D | | | | | | | |
| Shell Material and Finish | Aluminum-Shell 1 - Cadmium 4 - Black Anodize 6 - Chem Film | | 2 - Nickel 5 - Gold | | Stainless Steel Shell 3 - Passivated | | | |
| Insulator Material | L - LCP or PPS LCP - 30% Glass-Filled Liquid Crystal Polymer/ PPS - 40% Glass Filled Polyphenylene Sulfide | | | | | | | |
| Contact Layout | 9, 15, 21, 25, 31, 37, 51-2 (See Table I) | | | | | | | |
| Contact Type | P - Pin S - Socket | | | | | | | |
| Termination Type | SMR - Surface Mount Right Angle | | | | | | | |
| Jackpost or Jackscrew Option | N - Thru-Hole P - Jackpost M - Jackscrew, Hex Head T - Threaded Insert | | Jackposts for Rear Panel Mounting R1 - .032" Panel R4 - .093" Panel R2 - .047" Panel R5 - .125" Panel R3 - .062" Panel R6 - .080" Panel | | | | | |
| Board Mounting Threaded Insert Option | N - Thru-Hole, No Insert T - Threaded Inserts | |   | | | | | |

Micro-D MWDM-SMR Surface Mount Right Angle Dimensions



Table I: Dimensions



| Layout | A Max. | | B | | C Max. | | D Max. | | F | |
|--------|--------|-------|-------------------|-------------------|--------|-------|--------|------|-------------------|-------------------|
| | In. | mm. | In. $\pm .005$ | mm. ± 0.13 | In. | mm. | In. | mm. | In. $\pm .003$ | mm. ± 0.08 |
| 9P | .785 | 19.94 | .565 | 14.35 | .333 | 8.46 | .184 | 4.67 | .183 | 4.65 |
| 9S | .785 | 19.94 | .565 | 14.35 | .400 | 10.16 | .250 | 6.35 | .195 | 4.95 |
| 15P | .935 | 23.75 | .715 | 18.16 | .483 | 12.27 | .184 | 4.67 | .183 | 4.65 |
| 15S | .935 | 23.75 | .715 | 18.16 | .551 | 14.00 | .250 | 6.35 | .195 | 4.95 |
| 21P | 1.085 | 27.56 | .865 | 21.97 | .633 | 16.08 | .184 | 4.67 | .183 | 4.65 |
| 21S | 1.085 | 27.56 | .865 | 21.97 | .701 | 17.81 | .250 | 6.35 | .195 | 4.95 |
| 25P | 1.185 | 30.01 | .965 | 24.51 | .733 | 18.62 | .184 | 4.67 | .183 | 4.65 |
| 25S | 1.185 | 30.01 | .965 | 24.51 | .801 | 20.35 | .250 | 6.35 | .195 | 4.95 |
| 31P | 1.335 | 33.91 | 1.115 | 28.32 | .883 | 22.43 | .184 | 4.67 | .183 | 4.65 |
| 31S | 1.335 | 33.91 | 1.115 | 28.32 | .951 | 24.16 | .250 | 6.35 | .195 | 4.95 |
| 37P | 1.485 | 37.72 | 1.265 | 32.13 | 1.033 | 26.24 | .184 | 4.67 | .183 | 4.65 |
| 37S | 1.485 | 37.72 | 1.265 | 32.13 | 1.101 | 27.96 | .250 | 6.35 | .195 | 4.95 |
| 51-2P | 1.840 | 46.74 | 1.615 | 41.02 | 1.375 | 34.93 | .184 | 4.67 | .183 | 4.65 |
| 51-2S | 1.840 | 46.74 | 1.615 | 41.02 | 1.444 | 36.68 | .250 | 6.35 | .195 | 4.95 |

Surface Mount MICRO-D Hardware Options

N



Thru-Hole
No jackpost supplied

P



Standard Jackpost
Factory installed with nut and lockwasher

R1 Thru R6



Jackpost for Rear Panel Mounting
Shipped loosely installed. Install with permanent threadlocking compound.

M



Jackscrew, Hex Drive
Attached with e-ring

T



Threaded Insert
#2-56 Thread

T



Board Mount Threaded Insert

Performance Specifications

| | |
|---------------------------|-------------------------------|
| Current Rating | 1 AMP |
| DWV | 600 VAC Sea level |
| Insulation Resistance | 5000 Megohms Minimum |
| Contact Resistance | 8 Milliohms Maximum |
| Low Level Contact Resist. | 32 Milliohms Maximum |
| Magnetic Permeability | 2 μ Maximum |
| Operating Temperature | -55° C. to +150° C. |
| Shock, Vibration | 50 g., 20g. |
| Mating Force | (10 Ounces) X (# of Contacts) |

Materials And Finishes

| | |
|------------------|--|
| Connector Shell | Aluminum Alloy 6061. See Ordering Info for Plating Options |
| Insulators | Liquid Crystal Polymer (LCP)/Polyphenylene Sulfide (PPS) |
| Interfacial Seal | Fluorosilicone Rubber, Blue |
| Pin Contact | Beryllium Copper Gold over Nickel Plating |
| Socket Contact | Copper Alloy Gold Over Nickel Plating |
| PCB Terminals | Gold Plated Copper Alloy, Solder Dipped |
| Hardware | 300 Series Stainless Steel |
| Encapsulant | Epoxy Resin Hysol EE4215 |

SMR Surface Mount Connector PCB Layouts

Suggested Printed Circuit Board Layout



9 Contacts



15 Contacts



21 Contacts



25 Contacts



31 Contacts



37 Contacts



51 Contacts

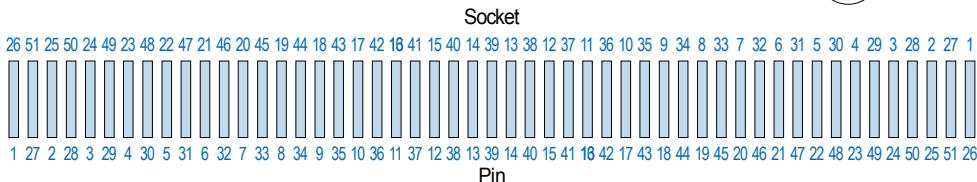

| Layout | A | | B | |
|--------|-------|-------|-------|-------|
| | In. | mm. | In. | mm. |
| 9 | .565 | 14.35 | .200 | 5.08 |
| 15 | .715 | 18.16 | .350 | 8.89 |
| 21 | .865 | 21.97 | .500 | 12.70 |
| 25 | .965 | 24.51 | .600 | 15.24 |
| 31 | 1.115 | 28.32 | .750 | 19.05 |
| 37 | 1.265 | 32.13 | .900 | 22.86 |
| 51-2 | 1.615 | 41.02 | 1.250 | 31.75 |



Micro-D GMR7580 Vertical Mount Printed Circuit Board Connectors



Save Space On Your Circuit Board – These Micro-D connectors feature .075 X .075 inch terminal spacing. Glenair's GMR7580 offers significant size and weight savings compared to traditional .100" pitch connectors.

High Performance – GMR7580 connectors meet the performance requirements of MIL-DTL-83513. Gold-plated TwistPin contacts assure best performance.

How To Order GMR7580 Vertical Mount Connectors

| Sample Part Number | GMR7580 | -31 | S | 2 | B | NN | 513 | | | | | | | | | | | | | | | | | | |
|-------------------------------|---|-----------------|---|---|---|----|-----|------------|----------------|-----------------|----|----|-------------|----|----|-------------|----|----|-------------|----|----|-------------|----|----|-------------|
| Series | GMR7580 - Micro-D Vertical Mount Connector | | | | | | | | | | | | | | | | | | | | | | | | |
| Contact Layout | 9, 15, 21, 25, 31, 37, 51, 100 (See Table II) | | | | | | | | | | | | | | | | | | | | | | | | |
| Contact Type | P - Pin S - Socket | | | | | | | | | | | | | | | | | | | | | | | | |
| Tail Length Inches (mm) | 1 - .109" (2.76) 2 - .150" (3.81) 3 - .190" (4.83) 4 - .250" (6.35) 5 - Staggered Tail Length Length in Inches ± .015 (0.38) | | | | | | | | | | | | | | | | | | | | | | | | |
| Shell Plating Finish | Aluminum Shell A - Cadmium B - Nickel C - Alchrome D - Black Anodize | | Stainless Steel Shell F - Passivated E - Gold | | | | | | | | | | | | | | | | | | | | | | |
| Hardware Option | NN - No Jackpost, No Threaded Insert PN - Extended Jackpost For .062" (1.6) PCB, No Threaded Insert RN - Extended Jackpost For .196" (5.0) PCB, No Threaded Insert NU - Threaded insert only, no jackposts NM - Metric Threaded Insert Only, No Jackposts SU - Short Jackpost and Threaded Insert SM - Short Jackpost and Metric Threaded Insert (See Table I) | | Rear Panel Mount Jackposts and Threaded Inserts <table border="1"> <thead> <tr> <th>UN Threads</th> <th>Metric Threads</th> <th>Panel Thickness</th> </tr> </thead> <tbody> <tr> <td>TU</td> <td>TM</td> <td>.094" (2.4)</td> </tr> <tr> <td>VU</td> <td>VM</td> <td>.062" (1.6)</td> </tr> <tr> <td>WU</td> <td>WM</td> <td>.047" (1.2)</td> </tr> <tr> <td>XU</td> <td>XM</td> <td>.031" (0.8)</td> </tr> <tr> <td>YU</td> <td>YM</td> <td>.023" (0.6)</td> </tr> </tbody> </table> | | | | | UN Threads | Metric Threads | Panel Thickness | TU | TM | .094" (2.4) | VU | VM | .062" (1.6) | WU | WM | .047" (1.2) | XU | XM | .031" (0.8) | YU | YM | .023" (0.6) |
| UN Threads | Metric Threads | Panel Thickness | | | | | | | | | | | | | | | | | | | | | | | |
| TU | TM | .094" (2.4) | | | | | | | | | | | | | | | | | | | | | | | |
| VU | VM | .062" (1.6) | | | | | | | | | | | | | | | | | | | | | | | |
| WU | WM | .047" (1.2) | | | | | | | | | | | | | | | | | | | | | | | |
| XU | XM | .031" (0.8) | | | | | | | | | | | | | | | | | | | | | | | |
| YU | YM | .023" (0.6) | | | | | | | | | | | | | | | | | | | | | | | |
| Gold-Plated Terminal Mod Code | These connectors are solder-dipped in 60/40 tin-lead solder. To delete the solder-dip and change to gold-plated terminals, add code 513 | | | | | | | | | | | | | | | | | | | | | | | | |

Table I: Jackpost Options

| NN | PN and RN | NU, NM | SU, SM | TU, VU, WU, XU, YU TM, VM, WM, XM, YM |
|-----------|--|------------------|-------------------------------|--|
| | | | | |
| Thru-Hole | Jackpost Kit PN - .062 (1.6) PCB RN - .196 (5.0) PCB | Threaded Inserts | Jackpost With Threaded Insert | Jackpost for Rear Panel Mounting |

Micro-D GMR7580 Vertical Mount Printed Circuit Board Connectors



Micro-D PCB

GMR7580 Connector Dimensions



C

| Layout | A Max. | | B | | C Max. | | D Max. | | E Max. | | F | | G Max. | | H Max. | |
|--------|--------|-------|-------------------|-------------------|--------|-------|--------|------|--------|-------|-------------------|-------------------|--------|-------|--------|-------|
| | In. | mm. | In. $\pm .005$ | mm. ± 0.13 | In. | mm. | In. | mm. | In. | mm. | In. $\pm .003$ | mm. ± 0.08 | In. | mm. | In. | mm. |
| 9P | .785 | 19.94 | .565 | 14.35 | .335 | 8.51 | .185 | 4.70 | .310 | 7.87 | .183 | 4.65 | .355 | 9.02 | .310 | 7.87 |
| 9S | .785 | 19.94 | .565 | 14.35 | .400 | 10.16 | .251 | 6.38 | .310 | 7.87 | .195 | 4.95 | .355 | 9.02 | .310 | 7.87 |
| 15P | .935 | 23.75 | .715 | 18.16 | .485 | 12.32 | .185 | 4.70 | .310 | 7.87 | .183 | 4.65 | .355 | 9.02 | .310 | 7.87 |
| 15S | .935 | 23.75 | .715 | 18.16 | .550 | 13.97 | .251 | 6.38 | .310 | 7.87 | .195 | 4.95 | .355 | 9.02 | .310 | 7.87 |
| 21P | 1.085 | 27.56 | .865 | 21.97 | .635 | 16.13 | .185 | 4.70 | .310 | 7.87 | .183 | 4.65 | .355 | 9.02 | .310 | 7.87 |
| 21S | 1.085 | 27.56 | .865 | 21.97 | .700 | 17.78 | .251 | 6.38 | .310 | 7.87 | .195 | 4.95 | .355 | 9.02 | .310 | 7.87 |
| 25P | 1.185 | 30.01 | .965 | 24.51 | .735 | 18.67 | .185 | 4.70 | .310 | 7.87 | .183 | 4.65 | .355 | 9.02 | .310 | 7.87 |
| 25S | 1.185 | 30.01 | .965 | 24.51 | .800 | 20.32 | .251 | 6.38 | .310 | 7.87 | .195 | 4.95 | .355 | 9.02 | .310 | 7.87 |
| 31P | 1.335 | 33.91 | 1.115 | 28.32 | .885 | 22.48 | .185 | 4.70 | .310 | 7.87 | .183 | 4.65 | .355 | 9.02 | .310 | 7.87 |
| 31S | 1.335 | 33.91 | 1.115 | 28.32 | .950 | 24.13 | .251 | 6.38 | .310 | 7.87 | .195 | 4.95 | .355 | 9.02 | .310 | 7.87 |
| 37P | 1.485 | 37.72 | 1.265 | 32.13 | 1.035 | 26.29 | .185 | 4.70 | .310 | 7.87 | .183 | 4.65 | .355 | 9.02 | .310 | 7.87 |
| 37S | 1.485 | 37.72 | 1.265 | 32.13 | 1.100 | 27.94 | .251 | 6.38 | .310 | 7.87 | .195 | 4.95 | .355 | 9.02 | .310 | 7.87 |
| 51P | 1.435 | 36.45 | 1.215 | 30.86 | .985 | 25.02 | .228 | 5.79 | .351 | 8.92 | .183 | 4.65 | .355 | 9.02 | .351 | 8.92 |
| 51S | 1.435 | 36.45 | 1.215 | 30.86 | 1.050 | 26.67 | .296 | 7.52 | .351 | 8.92 | .195 | 4.95 | .355 | 9.02 | .351 | 8.92 |
| 100P | 2.170 | 55.12 | 1.800 | 45.72 | 1.384 | 35.15 | .271 | 6.88 | .470 | 11.94 | .183 | 4.65 | .430 | 10.92 | .470 | 11.94 |
| 100S | 2.170 | 55.12 | 1.800 | 45.72 | 1.451 | 36.86 | .333 | 8.46 | .470 | 11.94 | .195 | 4.95 | .430 | 10.92 | .470 | 11.94 |

| Performance Specifications | |
|----------------------------|-------------------------------|
| Current Rating | 3 AMP |
| DWV | 600 VAC Sea level |
| Insulation Resistance | 5000 Megohms Minimum |
| Contact Resistance | 8 Milliohms Maximum |
| Low Level Contact Resist. | 32 Milliohms Maximum |
| Magnetic Permeability | 2 μ Maximum |
| Operating Temperature | -55° C. to +150° C. |
| Shock, Vibration | 50 g., 20g. |
| Mating Force | (10 Ounces) X (# of Contacts) |

| Materials and Finishes | |
|------------------------|---|
| Connector Shell | Aluminum Alloy 6061 or Stainless Steel, 300 Series, passivated. See Ordering Info for Plating Options |
| Insulator, Tray | Liquid Crystal Polymer (LCP) Polyphenylene Sulfide (PPS) |
| Interfacial Seal | Fluorosilicone Rubber, Blue |
| Pin Contact | Copper Alloy, Gold over Nickel Plating |
| Socket Contact | Copper Alloy, Gold Over Nickel Plating |
| PCB Terminals | Tin Plated Copper Alloy (100% Tin) |
| Hardware | 300 Series Stainless Steel |
| Encapsulant | Epoxy Resin Hysol EE4215 |



**Micro-D GMR7580
Vertical Mount
Printed Circuit Board Connectors**

GMR7580 Connector PCB Layouts – Pin Connectors

Patterns shown are for connector mounting side of PC board.



9 PIN



15 PIN



21 PIN



25 PIN



31 PIN



37 PIN



51 PIN



100 PIN

GMR7580 Connector PCB Layouts – Socket Connectors

Patterns shown are for connector mounting side of PC board.



9 SOCKET



15 SOCKET



21 SOCKET



25 SOCKET



31 SOCKET



37 SOCKET



51 SOCKET



100 SOCKET



Micro-D GMR7590 Right Angle Mount Printed Circuit Board Connectors



Save Space On Your Circuit Board – These Micro-D connectors feature .075 X .075 inch terminal spacing. Glenair's GMR7590 offers size and weight savings compared to traditional .100" pitch connectors.

High Performance – GMR7590 connectors meet the performance requirements of MIL-DTL-83513. Gold plated TwistPin contacts assure best electrical and mechanical performance.

How To Order GMR7590 Connectors

| | GMR7590 | -31 | S | 2 | B | SU | 513 | | | | | | | | | | | | | | | | | | |
|--------------------------------------|--|-----------------|----------|---|----------|-----------|------------|------------|----------------|-----------------|----|----|-------------|----|----|-------------|----|----|-------------|----|----|-------------|----|----|-------------|
| Series | GMR7590 Right Angle Mount Connector | | | | | | | | | | | | | | | | | | | | | | | | |
| Contact Layout | 9, 15, 21, 25, 31, 37, 51, 100, | | | | | | | | | | | | | | | | | | | | | | | | |
| Contact Type | P - Pin S - Socket | | | | | | | | | | | | | | | | | | | | | | | | |
| Tail Length in Inches (mm.) | 1 - .109" (2.76) 2 - .150" (3.81) 3 - .190" (4.83) 4 - .250" (6.35) 5 - Staggered Tail Length Length in Inches ± .015 (0.38) | | | | | | | | | | | | | | | | | | | | | | | | |
| Shell Plating Finish | Aluminum Shell A - Cadmium B - Nickel C - Allochrome D - Black Anodize E - Gold | | | Stainless Steel Shell F - Passivated | | | | | | | | | | | | | | | | | | | | | |
| Jackpost Options | NN - No Jackpost, No Threaded Insert NU - Threaded Insert Only, No Jackposts NM - Metric Threaded Insert Only, No Jackposts SU - Short Jackpost and threaded Insert SM - Short Jackpost and Metric Threaded Insert SN - Short Jackpost, No Threaded Insert (See Table I) | | | Rear Panel Mount Jackposts and Threaded Inserts <table border="1"> <thead> <tr> <th>UN Threads</th> <th>Metric Threads</th> <th>Panel Thickness</th> </tr> </thead> <tbody> <tr> <td>TU</td> <td>TM</td> <td>.094" (2.4)</td> </tr> <tr> <td>VU</td> <td>VM</td> <td>.062" (1.6)</td> </tr> <tr> <td>WU</td> <td>WM</td> <td>.047" (1.2)</td> </tr> <tr> <td>XU</td> <td>XM</td> <td>.031" (0.8)</td> </tr> <tr> <td>YU</td> <td>YM</td> <td>.023" (0.6)</td> </tr> </tbody> </table> | | | | UN Threads | Metric Threads | Panel Thickness | TU | TM | .094" (2.4) | VU | VM | .062" (1.6) | WU | WM | .047" (1.2) | XU | XM | .031" (0.8) | YU | YM | .023" (0.6) |
| UN Threads | Metric Threads | Panel Thickness | | | | | | | | | | | | | | | | | | | | | | | |
| TU | TM | .094" (2.4) | | | | | | | | | | | | | | | | | | | | | | | |
| VU | VM | .062" (1.6) | | | | | | | | | | | | | | | | | | | | | | | |
| WU | WM | .047" (1.2) | | | | | | | | | | | | | | | | | | | | | | | |
| XU | XM | .031" (0.8) | | | | | | | | | | | | | | | | | | | | | | | |
| YU | YM | .023" (0.6) | | | | | | | | | | | | | | | | | | | | | | | |
| Gold-Plated Terminal Mod Code | These connectors are solder-dipped in 60/40 tin-lead solder. To delete the solder dip and change to gold-plated terminals, add code 513 | | | | | | | | | | | | | | | | | | | | | | | | |

Table I: Jackpost Options

| NN | NU, NM | SN | SU, SM | TU, VU, WU, XU, YU TM, VM, WM, XM, YM |
|--|---|---|-------------------------------|--|
| | | | | |
| No Jackpost, No Threaded Insert In PCB Mtng Hole | No Jackpost, Threaded Insert In PCB Mounting Hole | Jackpost Installed, No Threaded Insert in PCB Mounting Hole | Jackpost With Threaded Insert | Jackpost for Rear Panel Mounting |

Micro-D GMR7590 Right Angle Mount Printed Circuit Board Connectors



Table II: Dimensions



SIZES 9 THRU 51 MOUNTING HOLE IS .088/.096 (2.24/2.39)
SIZE 100 MOUNTING HOLE IS .145/.151 (3.68/3.81)

SIZES 9 THRU 51 THREAD SIZE IS #2-56 UNC OR M2.
SIZE 100 THREAD SIZE IS #4-40 OR M3.

| Layout | A Max. | | B | | C Max. | | D Max. | | E Max. | | F | | G Max. | | H | |
|--------|--------|-------|---------------|---------------|--------|-------|--------|------|--------|-------|---------------|---------------|--------|-------|---------------|---------------|
| | In. | mm. | In. ± .005 | mm. ± 0.13 | In. | mm. | In. | mm. | In. | mm. | In. ± .003 | mm. ± 0.08 | In. | mm. | In. ± .010 | mm. ± 0.25 |
| 9P | .785 | 19.94 | .565 | 14.35 | .335 | 8.51 | .185 | 4.70 | .310 | 7.87 | .183 | 4.65 | .400 | 10.16 | .250 | 6.35 |
| 9S | .785 | 19.94 | .565 | 14.35 | .400 | 10.16 | .251 | 6.38 | .310 | 7.87 | .195 | 4.95 | .400 | 10.16 | .250 | 6.35 |
| 15P | .935 | 23.75 | .715 | 18.16 | .485 | 12.32 | .185 | 4.70 | .310 | 7.87 | .183 | 4.65 | .400 | 10.16 | .250 | 6.35 |
| 15S | .935 | 23.75 | .715 | 18.16 | .550 | 13.97 | .251 | 6.38 | .310 | 7.87 | .195 | 4.95 | .400 | 10.16 | .250 | 6.35 |
| 21P | 1.085 | 27.56 | .865 | 21.97 | .635 | 16.13 | .185 | 4.70 | .310 | 7.87 | .183 | 4.65 | .400 | 10.16 | .250 | 6.35 |
| 21S | 1.085 | 27.56 | .865 | 21.97 | .700 | 17.78 | .251 | 6.38 | .310 | 7.87 | .195 | 4.95 | .400 | 10.16 | .250 | 6.35 |
| 25P | 1.185 | 30.01 | .965 | 24.51 | .735 | 18.67 | .185 | 4.70 | .310 | 7.87 | .183 | 4.65 | .400 | 10.16 | .250 | 6.35 |
| 25S | 1.185 | 30.01 | .965 | 24.51 | .800 | 20.32 | .251 | 6.38 | .310 | 7.87 | .195 | 4.95 | .400 | 10.16 | .250 | 6.35 |
| 31P | 1.335 | 33.91 | 1.115 | 28.32 | .885 | 22.48 | .185 | 4.70 | .310 | 7.87 | .183 | 4.65 | .400 | 10.16 | .250 | 6.35 |
| 31S | 1.335 | 33.91 | 1.115 | 28.32 | .950 | 24.13 | .251 | 6.38 | .310 | 7.87 | .195 | 4.95 | .400 | 10.16 | .250 | 6.35 |
| 37P | 1.485 | 37.72 | 1.265 | 32.13 | 1.035 | 26.29 | .185 | 4.70 | .310 | 7.87 | .183 | 4.65 | .400 | 10.16 | .250 | 6.35 |
| 37S | 1.485 | 37.72 | 1.265 | 32.13 | 1.100 | 27.94 | .251 | 6.38 | .310 | 7.87 | .195 | 4.95 | .400 | 10.16 | .250 | 6.35 |
| 51P | 1.435 | 36.45 | 1.215 | 30.86 | .985 | 25.02 | .228 | 5.79 | .351 | 8.92 | .183 | 4.65 | .490 | 12.45 | .300 | 7.62 |
| 51S | 1.435 | 36.45 | 1.215 | 30.86 | 1.050 | 26.67 | .296 | 7.52 | .351 | 8.92 | .195 | 4.95 | .490 | 12.45 | .300 | 7.62 |
| 100P | 2.170 | 55.12 | 1.800 | 45.72 | 1.384 | 35.15 | .271 | 6.88 | .394 | 10.00 | .183 | 4.65 | .660 | 16.76 | .400 | 10.16 |
| 100S | 2.170 | 55.12 | 1.800 | 45.72 | 1.451 | 36.86 | .333 | 8.46 | .394 | 10.00 | .195 | 4.95 | .660 | 16.76 | .400 | 10.16 |

| Performance Specifications | |
|----------------------------|-------------------------------|
| Current Rating | 3 AMP |
| DWV | 600 VAC Sea level |
| Insulation Resistance | 5000 Megohms Minimum |
| Contact Resistance | 8 Milliohms Maximum |
| Low Level Contact Resist. | 32 Milliohms Maximum |
| Magnetic Permeability | 2 μ Maximum |
| Operating Temperature | -55° C. to +150° C. |
| Shock, Vibration | 50 g., 20g. |
| Mating Force | (10 Ounces) X (# of Contacts) |

| Materials and Finishes | |
|------------------------|---|
| Connector Shell | Aluminum Alloy 6061 or Stainless Steel, 300 Series, passivated. See Ordering Info for Plating Options |
| Insulator, Tray | Liquid Crystal Polymer (LCP) Polyphenylene Sulfide (PPS) |
| Interfacial Seal | Fluorosilicone Rubber, Blue |
| Pin Contact | Copper Alloy, Gold over Nickel Plating |
| Socket Contact | Copper Alloy, Gold Over Nickel Plating |
| PCB Terminals | Tin Plated Copper Alloy Sn60/Pb40 |
| Hardware | 300 Series Stainless Steel |
| Encapsulant | Epoxy Resin Hysol EE4215 |



Micro-D GMR7590 Right Angle Mount Printed Circuit Board Connectors

GMR7590 Connector PCB Layouts – Pin Connectors

Patterns shown are for connector mounting side of PC board.



9 PIN



15 PIN



21 PIN



25 PIN



31 PIN



37 PIN



51 PIN



100 PIN

GMR7590 Connector PCB Layouts – Socket Connectors

Patterns shown are for connector mounting side of PC board.



9 SOCKET



15 SOCKET



21 SOCKET



25 SOCKET



31 SOCKET



37 SOCKET



51 SOCKET



100 SOCKET



Micro-D GMR7580C Compact Flange Vertical Mount Printed Circuit Board Connector



Innovative Design for Flex Circuits – These Micro-D connectors answer the need for a compact flex circuit connector. Featuring .075 X .075 inch row spacing. Glenair's GMR7580C accepts standard jackscrews and jackposts, making it ideal for flex-to-board applications.

High Performance – GMR7580C connectors meet the performance requirements of MIL-DTL-83513. Gold-plated TwistPin contacts assure best electrical and mechanical performance.

How To Order GMR7580 Vertical .075" Pitch Connectors

| Sample Part Number | GMR7580C | -31 | S | 2 | B | S1 | 513 |
|-------------------------------|--|-----|---|---|---|----|-----|
| Series | GMR7580C Micro-D Metal Shell, Vertical Mount PCB, Compact | | | | | | |
| Contact Layout | 9, 15, 21, 25, 31, 37, 51, 100 (Table II) | | | | | | |
| Contact Type | P - Pin S - Socket | | | | | | |
| Tail Length in Inches (mm.) | 1 - .109" (2.76) 2 - .150" (3.81) 3 - .190" (4.83) 4 - .250" (6.35) 5 - Staggered Tail Length Length in Inches \pm .015 (0.38) | | | | | | |
| Shell Plating Finish | Aluminum Shell A - Cadmium B - Nickel C - Allochrome | | | Stainless Steel Shell F - Passivated D - Black Anodize E - Gold | | | |
| Mounting Hardware | B, P, M, M1, S, S1, L, K, F, R (See Table I) | | | | | | |
| Gold-Plated Terminal Mod Code | These connectors are solder-dipped in 60/40 tin-lead solder. To delete the solder dip and change to gold-plated terminals, add code 513 | | | | | | |

Table I: Mounting Hardware

| B | P | M | M1 | S | S1 | L | K | F | R |
|--|---|--|--|---|---|--|---|---|--|
| | | | | | | | | | |
| Thru-Hole Order Hardware Separately | Jackpost Removable Includes Nut and Washer | Jackscrew Hex Head Removable E-ring | Jackscrew Hex Head Removable E-ring Extended | Jackscrew Slot Head Removable E-ring | Jackscrew Slot Head Removable E-ring Extended | Jackscrew Hex Head Non- Removable | Jackscrew Slot Head Non- Removable Extended | Float Mount For Front Panel Mounting | Float Mount For Rear Panel Mounting |

Micro-D GMR7580C Compact Flange Vertical Mount Printed Circuit Board Connector



Table II: Dimensions



SIZES 9 THRU 51 MOUNTING HOLE IS .088/096 (2.24/2.39)
SIZE 100 MOUNTING HOLE IS .145/.151 (3.68/3.81)

SIZES 9 THRU 51 THREAD SIZE IS #2-56 UNC
SIZE 100 THREAD SIZE IS #4-40

| Layout | A Max. | | B | | C Max. | | D Max. | | E Max. | | F | | G Max. | | H Max. | |
|--------|--------|-------|------------|------------|--------|-------|--------|------|--------|-------|------------|------------|--------|-------|--------|-------|
| | In. | mm. | In. ± .005 | mm. ± 0.13 | In. | mm. | In. | mm. | In. | mm. | In. ± .003 | mm. ± 0.08 | In. | mm. | In. | mm. |
| 9P | .785 | 19.94 | .565 | 14.35 | .335 | 8.51 | .185 | 4.70 | .310 | 7.87 | .183 | 4.65 | .355 | 9.02 | .310 | 7.87 |
| 9S | .785 | 19.94 | .565 | 14.35 | .400 | 10.16 | .251 | 6.38 | .310 | 7.87 | .195 | 4.95 | .355 | 9.02 | .310 | 7.87 |
| 15P | .935 | 23.75 | .715 | 18.16 | .485 | 12.32 | .185 | 4.70 | .310 | 7.87 | .183 | 4.65 | .355 | 9.02 | .310 | 7.87 |
| 15S | .935 | 23.75 | .715 | 18.16 | .550 | 13.97 | .251 | 6.38 | .310 | 7.87 | .195 | 4.95 | .355 | 9.02 | .310 | 7.87 |
| 21P | 1.085 | 27.56 | .865 | 21.97 | .635 | 16.13 | .185 | 4.70 | .310 | 7.87 | .183 | 4.65 | .355 | 9.02 | .310 | 7.87 |
| 21S | 1.085 | 27.56 | .865 | 21.97 | .700 | 17.78 | .251 | 6.38 | .310 | 7.87 | .195 | 4.95 | .355 | 9.02 | .310 | 7.87 |
| 25P | 1.185 | 30.01 | .965 | 24.51 | .735 | 18.67 | .185 | 4.70 | .310 | 7.87 | .183 | 4.65 | .355 | 9.02 | .310 | 7.87 |
| 25S | 1.185 | 30.01 | .965 | 24.51 | .800 | 20.32 | .251 | 6.38 | .310 | 7.87 | .195 | 4.95 | .355 | 9.02 | .310 | 7.87 |
| 31P | 1.335 | 33.91 | 1.115 | 28.32 | .885 | 22.48 | .185 | 4.70 | .310 | 7.87 | .183 | 4.65 | .355 | 9.02 | .310 | 7.87 |
| 31S | 1.335 | 33.91 | 1.115 | 28.32 | .950 | 24.13 | .251 | 6.38 | .310 | 7.87 | .195 | 4.95 | .355 | 9.02 | .310 | 7.87 |
| 37P | 1.485 | 37.72 | 1.265 | 32.13 | 1.035 | 26.29 | .185 | 4.70 | .310 | 7.87 | .183 | 4.65 | .355 | 9.02 | .310 | 7.87 |
| 37S | 1.485 | 37.72 | 1.265 | 32.13 | 1.100 | 27.94 | .251 | 6.38 | .310 | 7.87 | .195 | 4.95 | .355 | 9.02 | .310 | 7.87 |
| 51P | 1.435 | 36.45 | 1.215 | 30.86 | .985 | 25.02 | .228 | 5.79 | .351 | 8.92 | .183 | 4.65 | .355 | 9.02 | .351 | 8.92 |
| 51S | 1.435 | 36.45 | 1.215 | 30.86 | 1.050 | 26.67 | .296 | 7.52 | .351 | 8.92 | .195 | 4.95 | .355 | 9.02 | .351 | 8.92 |
| 100P | 2.170 | 55.12 | 1.800 | 45.72 | 1.384 | 35.15 | .271 | 6.88 | .394 | 10.00 | .183 | 4.65 | .430 | 10.92 | .470 | 11.94 |
| 100S | 2.170 | 55.12 | 1.800 | 45.72 | 1.451 | 36.86 | .333 | 8.46 | .394 | 10.00 | .195 | 4.95 | .430 | 10.92 | .470 | 11.94 |

| Performance Specifications | |
|----------------------------|-------------------------------|
| Current Rating | 3 AMP |
| DWV | 600 VAC Sea level |
| Insulation Resistance | 5000 Megohms Minimum |
| Contact Resistance | 8 Milliohms Maximum |
| Low Level Contact Resist. | 32v Milliohms Maximum |
| Magnetic Permeability | 2 μ Maximum |
| Operating Temperature | -55° C. to +150° C. |
| Shock, Vibration | 50 g., 20g. |
| Mating Force | (10 Ounces) X (# of Contacts) |

| Materials and Finishes | |
|------------------------|---|
| Connector Shell | Aluminum Alloy 6061 or Stainless Steel, 300 Series, passivated. See Ordering Info for Plating Options |
| Insulator, Tray | Liquid Crystal Polymer (LCP) Polyphenylene Sulfide (PPS) |
| Interfacial Seal | Fluorosilicone Rubber, Blue |
| Pin Contact | Copper Alloy, Gold over Nickel Plating |
| Socket Contact | Copper Alloy, Gold Over Nickel Plating |
| PCB Terminals | Tin Plated Copper Alloy (100% Tin) |
| Hardware | 300 Series Stainless Steel |
| Encapsulant | Epoxy Resin Hysol EE4215 |



Micro-D GMR7580C Compact Flange Vertical Mount Printed Circuit Board Connector

GMR7580C Connector PCB Layouts – Pin Connectors

Patterns shown are for connector mounting side of PC board.



9 PIN



15 PIN



21 PIN



25 PIN



31 PIN



37 PIN



51 PIN



100 PIN

Micro-D GMR7580C Compact Flange
Vertical Mount
Printed Circuit Board Connector



GMR7580C Connector PCB Layouts – Socket Connectors

Patterns shown are for connector mounting side of PC board.



9 SOCKET



15 SOCKET



21 SOCKET



25 SOCKET



31 SOCKET



37 SOCKET



51 SOCKET



100 SOCKET





Micro-D GMR7590C Compact Flange Right Angle Mount Printed Circuit Board Connector



Innovative Design for Flex Circuits – These Micro-D connectors answer the need for a compact flex circuit connector. Featuring .075 X .075 inch row spacing. Glenair's GMR7590C accepts standard jackscrews and jackposts, making it ideal for flex-to-board applications.

High Performance – GMR7590C connectors meet the performance requirements of MIL-DTL-83513. Gold plated TwistPin contacts assure best electrical and mechanical performance.

How To Order GMR7590 Connectors

| Sample Part Number | GMR7590C | -31 | S | 2 | B | S1 | 513 |
|-------------------------------|--|-----|---|---|---|----|-----|
| Series | GMR7590C Micro-D Right Angle Mount Connector | | | | | | |
| Contact Layout | 9, 15, 21, 25, 31, 37, 51, 100 (See Table I) | | | | | | |
| Contact Type | P - Pin S - Socket | | | | | | |
| Tail Length in Inches (mm.) | 1 - .109" (2.76) 2 - .150" (3.81) 3 - .190" (4.83) 4 - .250" (6.35) 5 - Staggered Tail Length Length in Inches \pm .015 (0.38) | | | | | | |
| Shell Plating Finish | Aluminum Shell A - Cadmium B - Nickel C - Allochrome D - Black Anodize E - Gold | | | Stainless Steel Shell F - Passivated | | | |
| Hardware | B, P, M, M1, S, S1, L, K, F, R (See Table I) | | | | | | |
| Gold-Plated Terminal Mod Code | These connectors are solder-dipped in 60/40 tin-lead solder. To delete the solder dip and change to gold-plated terminals, add code 513 | | | | | | |

Table I: Mounting Hardware

| B | P | M | M1 | S | S1 | L | K | F | R |
|--|---|--|--|---|---|--|---|---|--|
| | | | | | | | | | |
| Thru-Hole Order Hardware Separately | Jackpost Removable Includes Nut and Washer | Jackscrew Hex Head Removable E-ring | Jackscrew Hex Head Removable E-ring Extended | Jackscrew Slot Head Removable E-ring | Jackscrew Slot Head Removable E-ring Extended | Jackscrew Hex Head Non- Removable | Jackscrew Slot Head Non- Removable Extended | Float Mount For Front Panel Mounting | Float Mount For Rear Panel Mounting |

Micro-D GMR7590C Compact Flange Right Angle Mount Printed Circuit Board Connector



Table II: Dimensions



STAGGERED LEADS

SIZES 9 THRU 51 MOUNTING HOLE IS .088/.096 (2.24/2.39)
SIZE 100 MOUNTING HOLE IS .145/.151 (3.68/3.81)

SIZES 9 THRU 51 THREAD SIZE IS #2-56 UNC
SIZE 100 THREAD SIZE IS #4-40

| Layout | A Max. | | B | | C Max. | | D Max. | | E Max. | | F | | G Max. | | H | |
|--------|--------|-------|------------|------------|--------|-------|--------|------|--------|-------|------------|------------|--------|-------|------------|------------|
| | In. | mm. | In. ± .005 | mm. ± 0.13 | In. | mm. | In. | mm. | In. | mm. | In. ± .003 | mm. ± 0.08 | In. | mm. | In. ± .010 | mm. ± 0.25 |
| 9P | .785 | 19.94 | .565 | 14.35 | .335 | 8.51 | .185 | 4.70 | .310 | 7.87 | .183 | 4.65 | .400 | 10.16 | .400 | 10.16 |
| 9S | .785 | 19.94 | .565 | 14.35 | .400 | 10.16 | .251 | 6.38 | .310 | 7.87 | .195 | 4.95 | .400 | 10.16 | .400 | 10.16 |
| 15P | .935 | 23.75 | .715 | 18.16 | .485 | 12.32 | .185 | 4.70 | .310 | 7.87 | .183 | 4.65 | .400 | 10.16 | .530 | 13.46 |
| 15S | .935 | 23.75 | .715 | 18.16 | .550 | 13.97 | .251 | 6.38 | .310 | 7.87 | .195 | 4.95 | .400 | 10.16 | .530 | 13.46 |
| 21P | 1.085 | 27.56 | .865 | 21.97 | .635 | 16.13 | .185 | 4.70 | .310 | 7.87 | .183 | 4.65 | .400 | 10.16 | .700 | 17.78 |
| 21S | 1.085 | 27.56 | .865 | 21.97 | .700 | 17.78 | .251 | 6.38 | .310 | 7.87 | .195 | 4.95 | .400 | 10.16 | .700 | 17.78 |
| 25P | 1.185 | 30.01 | .965 | 24.51 | .735 | 18.67 | .185 | 4.70 | .310 | 7.87 | .183 | 4.65 | .400 | 10.16 | .800 | 20.32 |
| 25S | 1.185 | 30.01 | .965 | 24.51 | .800 | 20.32 | .251 | 6.38 | .310 | 7.87 | .195 | 4.95 | .400 | 10.16 | .800 | 20.32 |
| 31P | 1.335 | 33.91 | 1.115 | 28.32 | .885 | 22.48 | .185 | 4.70 | .310 | 7.87 | .183 | 4.65 | .400 | 10.16 | .950 | 24.13 |
| 31S | 1.335 | 33.91 | 1.115 | 28.32 | .950 | 24.13 | .251 | 6.38 | .310 | 7.87 | .195 | 4.95 | .400 | 10.16 | .950 | 24.13 |
| 37P | 1.485 | 37.72 | 1.265 | 32.13 | 1.035 | 26.29 | .185 | 4.70 | .310 | 7.87 | .183 | 4.65 | .400 | 10.16 | 1.100 | 27.94 |
| 37S | 1.485 | 37.72 | 1.265 | 32.13 | 1.100 | 27.94 | .251 | 6.38 | .310 | 7.87 | .195 | 4.95 | .400 | 10.16 | 1.100 | 27.94 |
| 51P | 1.435 | 36.45 | 1.215 | 30.86 | .985 | 25.02 | .228 | 5.79 | .351 | 8.92 | .183 | 4.65 | .490 | 12.45 | 1.050 | 26.67 |
| 51S | 1.435 | 36.45 | 1.215 | 30.86 | 1.050 | 26.67 | .296 | 7.52 | .351 | 8.92 | .195 | 4.95 | .490 | 12.45 | 1.050 | 26.67 |
| 100P | 2.170 | 55.12 | 1.800 | 45.72 | 1.384 | 35.15 | .271 | 6.88 | .394 | 10.00 | .183 | 4.65 | .660 | 16.76 | 1.500 | 38.13 |
| 100S | 2.170 | 55.12 | 1.800 | 45.72 | 1.451 | 36.86 | .333 | 8.46 | .394 | 10.00 | .195 | 4.95 | .660 | 16.76 | 1.500 | 38.13 |

| Performance Specifications | |
|----------------------------|-------------------------------|
| Current Rating | 3 AMP |
| DWV | 600 VAC Sea level |
| Insulation Resistance | 5000 Megohms Minimum |
| Contact Resistance | 8 Milliohms Maximum |
| Low Level Contact Resist. | 32 Milliohms Maximum |
| Magnetic Permeability | 2 μ Maximum |
| Operating Temperature | -55° C. to +150° C. |
| Shock, Vibration | 50 g., 20g. |
| Mating Force | (10 Ounces) X (# of Contacts) |

| Materials and Finishes | |
|------------------------|---|
| Connector Shell | Aluminum Alloy 6061 or Stainless Steel, 300 Series, passivated. See Ordering Info for Plating Options |
| Insulator, Tray | Liquid Crystal Polymer (LCP) Polyphenylene Sulfide (PPS) |
| Interfacial Seal | Fluorosilicone Rubber, Blue |
| Pin Contact | Copper Alloy, Gold over Nickel Plating |
| Socket Contact | Copper Alloy, Gold Over Nickel Plating |
| PCB Terminals | Tin Plated Copper Alloy (100% Tin) |
| Hardware | 300 Series Stainless Steel |
| Encapsulant | Epoxy Resin Hysol EE4215 |



Micro-D GMR7590C Compact Flange Right Angle Mount Printed Circuit Board Connector

GMR7590C Connector PCB Layouts – Pin Connectors

Patterns shown are for connector mounting side of PC board.



Micro-D GMR7590C Compact Flange Right Angle Mount Printed Circuit Board Connector



GMR7590C Connector PCB Layouts – Socket Connectors

Patterns shown are for connector mounting side of PC board.



9 SOCKET



15 SOCKET



21 SOCKET



25 SOCKET



31 SOCKET



37 SOCKET



51 SOCKET



100 SOCKET



Micro-D GMLM MasterLatch® Rear Panel Mount, Condensed Board Straight, Vertical Printed Circuit Board Receptacle

Master Latch Rear Panel Mount Receptacle – These Micro-D's provide excellent shock and vibration performance thanks to our innovative MasterLatch® design. Once mated the latching mechanism prevents unwanted separation of mated GMLM connectors.

High Performance – GMLMR connectors meet the performance requirements of MIL-DTL-83513. Gold plated TwistPin contacts assure best electrical and mechanical performance.

How To Order GMLMR Connectors

| Sample Part Number | GMLMR | 2 | L | -25 | S | CBS | R3 | N | T | -.125 |
|----------------------------------|--|---|---|-----|---|-----|----|---|---|-------|
| Series | GMLMR Micro-D MasterLatch® | | | | | | | | | |
| Shell Material and Finish | 1 = Cadmium 2 = Nickel 4 = Black Anodize 5 = Gold 6 = Chem Film | | | | | | | | | |
| Insulator Material | L = LCP or PPS | | | | | | | | | |
| Contact Layout | 9 thru 37 See Table II | | | | | | | | | |
| Contact Type | S = Socket | | | | | | | | | |
| Termination Type | CBS = Condensed Board Straight | | | | | | | | | |
| Rear Panel Mount Hardware Option | B = No Hardware R1 = .032 panel R2 = .047 panel, R3 = .062 panel R4 = .093 panel R5 = .125 panel R6 = .080 panel | | | | | | | | | |
| O-Ring Type | C = Conductive N = Nitrile | | | | | | | | | |
| Threaded Insert | T = Threaded Insert | | | | | | | | | |
| Lead Length | .080, .110, .125, .140, .150, .172, .190, .250 | | | | | | | | | |

Table I: Jackpost Options

R1 Thru R6



Jackpost for Rear Panel Mounting
Shipped loosely installed. Install with permanent threadlocking compound.

Performance Specifications

| | |
|---------------------------|-------------------------------|
| Current Rating | 3 AMP |
| DWV | 600 VAC Sea level |
| Insulation Resistance | 5000 Megohms Minimum |
| Contact Resistance | 8 Milliohms Maximum |
| Low Level Contact Resist. | 32 Milliohms Maximum |
| Magnetic Permeability | 2 μ Maximum |
| Operating Temperature | -55° C. to +150° C. |
| Shock, Vibration | 50 g., 20g. |
| Mating Force | (10 Ounces) X (# of Contacts) |

Materials and Finishes

| | |
|------------------|---|
| Connector Shell | Aluminum alloy, see ordering info for plating options |
| Insulator | Liquid Crystal Polymer (LCP) Polyphenylene Sulfide (PPS) |
| Interfacial Seal | Fluorosilicone Rubber, Blue |
| Socket Contact | Phos Bronze/Gold Plate |
| Hardware | Stainless Steel/Passivate |
| Encapsulant | Epoxy Resin Hysol EE4215 |

Micro-D GMLM MasterLatch® Rear Panel Mount, Condensed Board Straight, Vertical Printed Circuit Board Receptacle

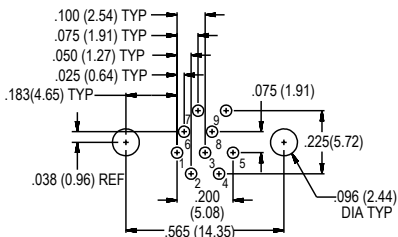

Table II: Dimensions

| Shell Size | A | ±.003 (.08) | B | C | D | E |
|------------|---------------|-------------|---------------|---------------|---------------|---------------|
| 9 | 1.410 (35.81) | | 0.965 (24.51) | 0.745 (18.92) | 0.565 (14.35) | 0.785 (19.94) |
| 15 | 1.560 (39.62) | | 1.115 (28.32) | 0.895 (22.73) | 0.715 (18.16) | 0.935 (23.75) |
| 21 | 1.710 (43.43) | | 1.265 (32.13) | 1.045 (26.54) | 0.865 (21.97) | 1.085 (27.56) |
| 25 | 1.810 (45.97) | | 1.365 (34.67) | 1.145 (29.08) | 0.965 (24.51) | 1.185 (30.10) |
| 31 | 1.960 (49.78) | | 1.515 (38.48) | 1.295 (32.89) | 1.115 (28.32) | 1.335 (33.91) |
| 37 | 2.110 (53.59) | | 1.665 (42.29) | 1.445 (36.70) | 1.265 (32.13) | 1.485 (37.72) |



Patterns shown are for connector mounting side of PC board.



9 SOCKET



15 SOCKET



21 SOCKET



25 SOCKET



31 SOCKET



37 SOCKET



Micro-D GMLM MasterLatch® Rear Panel Mount, Condensed Board Right Angle Printed Circuit Board Receptacle



Master Latch Rear Panel Mount Receptacle – These Micro-D's provide excellent shock and vibration performance thanks to our innovative MasterLatch® design. Once mated the latching mechanism prevents unwanted separation of mated GMLM connectors.

High Performance – GMLM connectors meet the performance requirements of MIL-DTL-83513. Gold plated TwistPin contacts assure best electrical and mechanical performance.

How To Order GMLMR Connectors

| Sample Part Number | GMLMR | 2 | L | -37 | S | CBR | B | T | N | -.150 |
|---------------------------|---|---|---|-----|---|-----|---|---|---|-------|
| Series | GMLMR Micro-D MasterLatch® | | | | | | | | | |
| Shell Material and Finish | 1 = Cadmium 2 = Nickel 4 = Black Anodize 5 = Gold 6 = Chem Film | | | | | | | | | |
| Insulator Material | L = LCP or PPS | | | | | | | | | |
| Contact Layout | 9 thru 37 See Table II | | | | | | | | | |
| Contact Type | S = Socket | | | | | | | | | |
| Termination Type | CBS = Condensed Board Right Angle | | | | | | | | | |
| RPM Hardware Option | B = No Hardware R1 = .032 panel R4 = .093 panel R5 = .125 panel | | R2 = .047 panel R3 = .062 panel R6 = .080 panel | | | | | | | |
| Threaded Insert Option | T = Threaded Insert in Board Mount Hardware Option | | | | | | | | | |
| O-Ring Type | C = Conductive N = Nonconductive (Nitrile) | | | | | | | | | |
| Lead Length | .080, .110, .125, .140, .150, .172, .190, .250 | | | | | | | | | |

Table I: Jackpost Options

| No Designator | R1 Thru R6 |
|---|--|
|  <p>THREADED INSERT</p> |  <p>Panel</p> |
| <p>Threaded Hole For use with Glennair jackposts only. Order hardware separately. Install with threadlocking compound.</p> | <p>Jackpost for Rear Panel Mounting Shipped loosely installed. Install with permanent threadlocking compound.</p> |

Micro-D GMLM MasterLatch® Rear Panel Mount, Condensed Board Right Angle Printed Circuit Board Receptacle



| Table II: Dimensions | | | | | | |
|----------------------|------------------|------------------|------------------|------------------|------------------|------------------|
| Shell Size | A | B Ref. | C | D | E | F |
| 9 | 1.410 (35.81) | .965 (24.51) | .745 (18.92) | .565 (14.35) | .785 (19.94) | 1.180 (29.97) |
| 15 | 1.560 (39.62) | 1.115 (28.32) | .895 (22.73) | .715 (18.16) | .935 (23.75) | 1.330 (33.78) |
| 21 | 1.710 (43.43) | 1.265 (32.13) | 1.045 (26.54) | .865 (21.97) | 1.085 (27.56) | 1.480 (37.59) |
| 25 | 1.810 (45.97) | 1.365 (34.67) | 1.145 (29.08) | .965 (24.51) | 1.185 (30.10) | 1.580 (40.13) |
| 31 | 1.960 (49.78) | 1.515 (38.48) | 1.295 (32.89) | 1.115 (28.32) | 1.335 (33.91) | 1.730 (43.94) |
| 37 | 2.110 (53.59) | 1.665 (42.29) | 1.445 (36.70) | 1.265 (32.13) | 1.485 (37.72) | 1.880 (47.75) |

| Performance Specifications | |
|----------------------------|-------------------------------|
| Current Rating | 3 AMP |
| DWV | 600 VAC Sea level |
| Insulation Resistance | 5000 Megohms Minimum |
| Contact Resistance | 8 Milliohms Maximum |
| Low Level Contact Resist. | 32 Milliohms Maximum |
| Magnetic Permeability | 2 μ Maximum |
| Operating Temperature | -55° C. to +150° C. |
| Shock, Vibration | 50 g., 20g. |
| Mating Force | (10 Ounces) X (# of Contacts) |

| Materials and Finishes | |
|------------------------|---|
| Connector Shell | Aluminum alloy, see ordering info for plating options |
| Insulator, Tray | Liquid Crystal Polymer (LCP) Polyphenylene Sulfide (PPS) |
| Interfacial Seal | Fluorosilicone Rubber, Blue |
| Socket Contact | Phos Bronze/Gold Plate |
| Hardware | Stainless Steel/Passivate |
| Encapsulant | Epoxy Resin Hysol EE4215 |

GMLM PCB Footprints



SERIES GMSM

LOW PROFILE MICRO-D



For compact applications



Turn to Glenair when board space is at a premium. Our Low Profile single Row Metal Shell Microminiature connectors feature machined aluminum or stainless steel shells with gold plated TwistPin contacts for superior performance and a reduced footprint. Our low profile connectors are available with solder cups, insulated or solid wire pigtailed in straight and right angle orientations. All of our low profile Micro-D rectangular connectors are available with flex circuit terminations, as well as turnkey point-to-point cordsets.



Glenair, Inc.

1211 Air Way
Glendale, CA
91201-2497

818-247-6000
sales@glenair.com
www.glenair.com

Section D Low Profile Single Row Metal Shell Microminiature



Product Selection Guide



Connector height is a priority for miniaturized electronics modules. These GMSM connectors are shorter and occupy less board real estate than comparable two row Micro-D connectors.

Solder Cup, Pre-wired and PCB Versions feature gold-plated TwistPin contacts, machined aluminum shells, and are fully potted with epoxy. The glass-filled thermoplastic LCP trays will withstand soldering heat without damage.

Eight Contact Arrangements – Choose from 4 to 35 contacts. Available in a variety of finishes, the socket connectors are fitted with Fluorosilicone interfacial seals.

GMSM Solder Cup
Connectors
Page D-2



GMSM Solder Cup Connectors

Nonremovable solder cup contacts for termination to #26 AWG or smaller wire, .050" contact spacing, eight layouts from 4 to 35 contacts.

GMSM Insulated
Wire Pigtails
Page D-2



GMSM Pre-Wired Pigtails

Crimp contacts are terminated to insulated Teflon® wire. Connectors are backpotted with epoxy, providing strain relief and environmental protection.

GMSM Solid Wire
Pigtails
Page D-3



GMSM with Solid Uninsulated Wire

Gold-plated or solder-dipped solid copper wire, crimp termination, backpotted with epoxy. Can be terminated to flexible circuits.

GMSM Right Angle
PCB
Page D-5



GMSM Right Angle Printed Circuit Board

.075 inch by .100 inch terminal spacing, for thru-hole rigid or flexible circuits. One piece threaded inserts provide a ground path from the jackpost to the board.



GMSM Solder Cup, Pre-Wired and Solid Wire Single Row Connector Low Profile Metal Shell Microminiature



GMSM Connectors offer mil spec design and performance in a smaller form factor. These GMSM single row connectors are reduced in height compared to two-row Micro-D connectors.

GMSM Connectors feature gold plated TwistPin contacts, machined aluminum shells, and are fully potted with epoxy. Choose from 4 to 35 contacts. Available in a variety of finishes, socket connectors are fitted with Fluorosilicone interfacial seals.

D

How To Order Solder Cup Connectors

| | | |
|---|---------------------------|---|
|  Solder Cup | Sample Part Number | GMSM 1- 15 P S B |
| | Series | GMSM Glenair Metal Shell Microminiature |
| | Shell Finish | Aluminum Shell Stainless Steel Shell 1 - Cadmium 2 - Nickel 3 - Passivated 4 - Black Anodize 5 - Gold 6 - Chem Film |
| | Contact Layout | 04, 06, 10, 15, 20, 25, 30, 35 (See Table II) |
| | Contact Type | P - Pin S - Socket |
| | Termination Type | S - Solder Cup |
| | Hardware | B, P, M, M1, S, S1, L, K, F, R (See Table I) |

How To Order Insulated Wire Connector

| | | |
|--|---------------------------|---|
|  Insulated Wire Pigtails | Sample Part Number | GMSM 2- 10 P- 6 K 1- 18 B |
| | Series | GMSM Glenair Metal Shell Microminiature |
| | Shell Finish | Aluminum Shell Stainless Steel Shell 1 - Cadmium 3 - Passivated 2 - Nickel 4 - Black Anodized 5 - Gold 6 - Chem Film |
| | Number of Contacts | 04, 06, 10, 15, 20, 25, 30, 35 (See Table II) |
| | Contact Type | P - Pin, S - Socket |
| | Wire Gage (AWG) | 4 - #24 6 - #26 8 - #28 AWG |
| | Wire Type | K - M22759/11 600 Vrms Teflon (TFE) [®] J - M22759/33600 Vrms Modified Cross-Linked Tefzel (ETFE) [®] E - NEMA HP3-EB 600 Vrms Type E M16878/4 (TFE) |
| | Wire Color Code | 1 - White 2 - Yellow 5 - Color-Coded Stripes Per MIL-STD-681 7 - 10 Color Repeating |
| | Wire Length Inches | 18 - Wire Length In Inches. "18" Specifies 18 Inches. |
| | Hardware | B, P, M, M1, S, S1, L, K, F, R (See Table I) |

GMSM Solder Cup, Pre-Wired and Solid Wire Single Row Connector Low Profile Metal Shell Microminiature



Micro-D
Single Row

How To Order Uninsulated Wire Connector

| | | | | | | | | | | | |
|---|---------------------------|---|--|------------------------|-----------|----------|----------|-----------|-------------|----------|--|
|  <p>Gold Plated or Solder Dipped Solid Leads</p> | Sample Part Number | GMSM | 2- | 10 | P- | 5 | C | 4- | .250 | P | |
| | Series | GMSM Glenair Metal Shell Microminiature | | | | | | | | | |
| | Shell Finish | Aluminum Shell 1 - Cadmium 2 - Nickel 4 - Black Anodized 5 - Gold 6 - Chem Film | Stainless Steel Shell 3 - Passivated | | | | | | | | |
| | Number of Contacts | 04, 06, 10, 15, 20, 25, 30, 35 (See Table II) | | | | | | | | | |
| | Contact Type | P - Pin, S - Socket | | | | | | | | | |
| | Wire Gage (AWG) | 4 - #24 5 - #26 6 - #26 | | | | | | | | | |
| | Wire Type | C - Copper Wire | | | | | | | | | |
| | Wire Finish | 3 - Solder Dipped (60/40/Tin/lead) | | 4 - Gold Plated | | | | | | | |
| | Wire Length Inches | .125, .250, .375, .500, .750, 1.000, 2.000 Wire Length In Inches. ".500" Specifies Half Inch. | | | | | | | | | |
| | Hardware | B, P, M, M1, S, S1, L, K, F, R (See Table I) | | | | | | | | | |

D

Table I: Mounting Hardware

| B | P | M | M1 | S | S1 | L | K | F | R |
|---|--|--|--|--|--|---|--|--|--|
|  |  |  |  |  |  |  |  |  |  |
| Thru-Hole Order Hardware Separately | Jackpost Removable Includes Nut and Washer | Jackscrew Hex Head Removable E-ring | Jackscrew Hex Head Removable E-ring Extended | Jackscrew Slot Head Removable E-ring | Jackscrew Slot Head Removable E-ring Extended | Jackscrew Hex Head Non-Removable | Jackscrew Slot Head Non-Removable Extended | Float Mount For Front Panel Mounting | Float Mount For Rear Panel Mounting |



GMSM Solder Cup, Pre-Wired and Solid Wire Single Row Connector Dimensions

Table II: Dimensions



Face View of Pin (Plug) Connector



Face View of Socket (Receptacle) Connector

| Layout | A Max. | | B | | C Max. | | D Max. | | E Max. | | F Max. | | G Max. | | H Max. | | J Max. | |
|--------|--------|-------|--------------|---------------|--------|-------|--------|------|--------|------|--------|------|--------|------|--------|-------|--------|------|
| | In. | mm. | In. ±.003 | mm. ± 0.08 | In. | mm. | In. | mm. | In. | mm. | In. | mm. | In. | mm. | In. | mm. | In. | mm. |
| 04P | .648 | 16.45 | .478 | 12.11 | .250 | 6.37 | .135 | 3.42 | .218 | 5.54 | .041 | 1.03 | .358 | 9.10 | .309 | 7.85 | .184 | 4.67 |
| 04S | .648 | 16.45 | .478 | 12.11 | .309 | 7.85 | .194 | 4.94 | .218 | 5.54 | .012 | 0.30 | .370 | 9.40 | .309 | 7.85 | .197 | 5.00 |
| 06P | .748 | 19.00 | .578 | 14.65 | .350 | 8.91 | .135 | 3.42 | .218 | 5.54 | .041 | 1.03 | .358 | 9.10 | .409 | 10.40 | .184 | 4.67 |
| 06S | .748 | 19.00 | .578 | 14.65 | .409 | 10.40 | .194 | 4.94 | .218 | 5.54 | .012 | 0.30 | .370 | 9.40 | .409 | 10.40 | .197 | 5.00 |
| 10P | .948 | 24.07 | .777 | 19.73 | .550 | 13.99 | .135 | 3.42 | .218 | 5.54 | .041 | 1.03 | .358 | 9.10 | .609 | 15.47 | .184 | 4.67 |
| 10S | .948 | 24.07 | .777 | 19.73 | .609 | 15.47 | .194 | 4.94 | .218 | 5.54 | .012 | 0.30 | .370 | 9.40 | .609 | 15.47 | .197 | 5.00 |
| 15P | 1.198 | 30.42 | 1.027 | 26.08 | .800 | 20.34 | .135 | 3.42 | .218 | 5.54 | .041 | 1.03 | .358 | 9.10 | .859 | 21.82 | .184 | 4.67 |
| 15S | 1.198 | 30.42 | 1.027 | 26.08 | .859 | 21.82 | .194 | 4.94 | .218 | 5.54 | .012 | 0.30 | .370 | 9.40 | .859 | 21.82 | .197 | 5.00 |
| 20P | 1.448 | 36.77 | 1.277 | 32.43 | 1.050 | 26.69 | .135 | 3.42 | .218 | 5.54 | .041 | 1.03 | .358 | 9.10 | 1.109 | 28.17 | .184 | 4.67 |
| 20S | 1.448 | 36.77 | 1.277 | 32.43 | 1.109 | 28.17 | .194 | 4.94 | .218 | 5.54 | .012 | 0.30 | .370 | 9.40 | 1.109 | 28.17 | .197 | 5.00 |
| 25P | 1.698 | 43.12 | 1.527 | 38.78 | 1.300 | 33.04 | .135 | 3.42 | .218 | 5.54 | .041 | 1.03 | .358 | 9.10 | 1.359 | 34.52 | .184 | 4.67 |
| 25S | 1.698 | 43.12 | 1.527 | 38.78 | 1.359 | 34.52 | .194 | 4.94 | .218 | 5.54 | .012 | 0.30 | .370 | 9.40 | 1.359 | 34.52 | .197 | 5.00 |
| 30P | 1.948 | 49.47 | 1.777 | 45.13 | 1.550 | 39.39 | .135 | 3.42 | .218 | 5.54 | .041 | 1.03 | .358 | 9.10 | 1.609 | 40.87 | .184 | 4.67 |
| 30S | 1.948 | 49.47 | 1.777 | 45.13 | 1.609 | 40.87 | .194 | 4.94 | .218 | 5.54 | .012 | 0.30 | .370 | 9.40 | 1.609 | 40.87 | .197 | 5.00 |
| 35P | 2.198 | 55.82 | 2.027 | 51.48 | 1.800 | 45.74 | .135 | 3.42 | .218 | 5.54 | .041 | 1.03 | .358 | 9.10 | 1.859 | 47.22 | .184 | 4.67 |
| 35S | 2.198 | 55.82 | 2.027 | 51.48 | 1.859 | 47.22 | .194 | 4.94 | .218 | 5.54 | .012 | 0.30 | .370 | 9.40 | 1.859 | 47.22 | .197 | 5.00 |

GMSM Right Angle Single Row PCB Connector Low Profile Metal Shell Microminiature



Micro-D
Single Row



Low Profile GMSM Single Row Micro Connectors offer mil spec design and performance in a smaller form factor for space savings. These GMSM connectors are shorter and occupy less board real estate than comparable two row Micro-D connectors.

GMSM Connectors feature gold-plated TwistPin contacts, machined aluminum shells, and are fully potted with epoxy. Choose from 4 to 35 contacts. Available in a variety of finishes, socket connectors are fitted with Fluorosilicone interfacial seals.

D

How To Order GMSM Right Angle PCB Connector

| | | | | | | | |
|---------------------------|---|---|---|----------------|--|--|--|
| Sample Part Number | GMSM 2- 10 P CBR SU 1 | | | | | | |
| Series | GMSM | | | | | | |
| Shell Finish | Aluminum Shell 1 - Cadmium 2 - Nickel 4 - Black Anodize 5 - Gold 6 - Chem Film | Stainless Steel Shell 3 - Passivated | | | | | |
| Contact Layout | 04, 06, 10, 15, 20, 25, 30, 35 (See Table II) | | | | | | |
| Contact Type | P - Pin S - Socket | | | | | | |
| Termination Style | CBR - Right Angle PCB | | | | | | |
| Hardware Option | NU - Threaded Insert Only, No Jackposts SU - Jackpost and Threaded Insert (See Table I) | | Rear Panel Jackposts with Threaded Inserts TU - 0.093" (2.4) Panel VU - 0.062" (1.6) Panel WU - 0.047" (1.2) Panel XU - 0.031" (0.8) Panel YU - 0.023" (0.6) Panel | | | | |
| Tail Length | 1 - .109 (2.8) | 2 - .150 (3.8) | 3 - .190 (4.8) | 4 - .250 (6.3) | | | |

Table I: Mounting Hardware

| NU | SU | TU, VU, WU, XU, YU |
|--|----------------------------------|-------------------------------------|
| | | |
| No Jackpost, Threaded Insert In PCB Mounting Hole | Jackpost With Threaded Insert | Jackpost for Rear Panel Mounting |



GMSM Right Angle Single Row PCB Connector Low Profile Metal Shell Microminiature

Table II: Dimensions



Face View of Pin (Plug) Connector



Face View of Socket (Receptacle) Connector

| Layout | A Max. | | B | | C Max. | | D Max. | | E Max. | | G Max. | | J Max. | | K | | L | |
|--------|--------|-------|--------------|---------------|--------|-------|--------|------|--------|------|--------|------|--------|------|--------------|---------------|--------------|---------------|
| | In. | mm. | In. ±.003 | mm. ± 0.08 | In. | mm. | In. | mm. | In. | mm. | In. | mm. | In. | mm. | In. ±.004 | mm. ± 0.10 | In. ±.010 | mm. ± 0.25 |
| 4P | .648 | 16.45 | .478 | 12.11 | .250 | 6.37 | .135 | 3.42 | .241 | 6.13 | .364 | 9.25 | .184 | 4.67 | .250 | 6.35 | .213 | 5.41 |
| 4S | .648 | 16.45 | .478 | 12.11 | .309 | 7.85 | .194 | 4.94 | .241 | 6.13 | .364 | 9.25 | .197 | 5.00 | .250 | 6.35 | .213 | 5.41 |
| 6P | .748 | 19.00 | .578 | 14.65 | .350 | 8.91 | .135 | 3.42 | .241 | 6.13 | .364 | 9.25 | .184 | 4.67 | .250 | 6.35 | .213 | 5.41 |
| 6S | .748 | 19.00 | .578 | 14.65 | .409 | 10.40 | .194 | 4.94 | .241 | 6.13 | .364 | 9.25 | .197 | 5.00 | .250 | 6.35 | .213 | 5.41 |
| 10P | .948 | 24.07 | .777 | 19.73 | .550 | 13.99 | .135 | 3.42 | .241 | 6.13 | .364 | 9.25 | .184 | 4.67 | .250 | 6.35 | .213 | 5.41 |
| 10S | .948 | 24.07 | .777 | 19.73 | .609 | 15.47 | .194 | 4.94 | .241 | 6.13 | .364 | 9.25 | .197 | 5.00 | .250 | 6.35 | .213 | 5.41 |
| 15P | 1.198 | 30.42 | 1.027 | 26.08 | .800 | 20.34 | .135 | 3.42 | .241 | 6.13 | .364 | 9.25 | .184 | 4.67 | .250 | 6.35 | .213 | 5.41 |
| 15S | 1.198 | 30.42 | 1.027 | 26.08 | .859 | 21.82 | .194 | 4.94 | .241 | 6.13 | .364 | 9.25 | .197 | 5.00 | .250 | 6.35 | .213 | 5.41 |
| 20P | 1.448 | 36.77 | 1.277 | 32.43 | 1.050 | 26.69 | .135 | 3.42 | .241 | 6.13 | .364 | 9.25 | .184 | 4.67 | .250 | 6.35 | .213 | 5.41 |
| 20S | 1.448 | 36.77 | 1.277 | 32.43 | 1.109 | 28.17 | .194 | 4.94 | .241 | 6.13 | .364 | 9.25 | .197 | 5.00 | .250 | 6.35 | .213 | 5.41 |
| 25P | 1.698 | 43.12 | 1.527 | 38.78 | 1.300 | 33.04 | .135 | 3.42 | .241 | 6.13 | .364 | 9.25 | .184 | 4.67 | .250 | 6.35 | .213 | 5.41 |
| 25S | 1.698 | 43.12 | 1.527 | 38.78 | 1.359 | 34.52 | .194 | 4.94 | .241 | 6.13 | .364 | 9.25 | .197 | 5.00 | .250 | 6.35 | .213 | 5.41 |
| 30P | 1.948 | 49.47 | 1.777 | 45.13 | 1.550 | 39.39 | .135 | 3.42 | .241 | 6.13 | .364 | 9.25 | .184 | 4.67 | .250 | 6.35 | .213 | 5.41 |
| 30S | 1.948 | 49.47 | 1.777 | 45.13 | 1.609 | 40.87 | .194 | 4.94 | .241 | 6.13 | .364 | 9.25 | .197 | 5.00 | .250 | 6.35 | .213 | 5.41 |
| 35P | 2.198 | 55.82 | 2.027 | 51.48 | 1.800 | 45.74 | .135 | 3.42 | .241 | 6.13 | .364 | 9.25 | .184 | 4.67 | .250 | 6.35 | .213 | 5.41 |
| 35S | 2.198 | 55.82 | 2.027 | 51.48 | 1.859 | 47.22 | .194 | 4.94 | .241 | 6.13 | .364 | 9.25 | .197 | 5.00 | .250 | 6.35 | .213 | 5.41 |

**GMSM Right Angle
Single Row PCB Connector
Low Profile Metal Shell Microminiature**



Micro-D
Single Row

GMSM PCB Layouts – Pin Connectors



4 PIN



6 PIN



10 PIN



15 PIN



20 PIN



25 PIN



30 PIN



35 PIN

D



GMSM Right Angle Single Row PCB Connector Low Profile Metal Shell Microminiature

GMSM PCB Layouts – Socket Connectors



D

Section E Low Profile Metal and Plastic Shell Micro-D



Product Selection Guide

MLDM Metal Shell
Solder Cup
Page E-3



MLDM Metal Shell, Solder Cup

Solder cup gold plated contacts accept #24-30 AWG solid or stranded wire. Available in 9 to 51 positions. High performance M83513 TwistPin contact system. Contacts are factory-installed, non-removable and epoxy encapsulated. 3 Amp, 600 Vac, -55°C to +150°C.

MLDM Metal Shell
Stranded Wire
Page E-5



MLDM Metal Shell, Stranded Wired

Pre-wired with #24 to #30 stranded wire. Available in 9 to 51 positions. High performance M83513 TwistPin contact system. 3 Amp, 600 Vac, -55°C to +150°C.

MLDM Metal Shell
Solid Wired
Page E-7



MLDM Metal Shell, Solid Wire

Pre-wired with #24 to #30 solid wire. Available in 9 to 51 positions. High performance M83513 TwistPin contact system. 3 Amp, 600 Vac, -55°C to +150°C.

MLDM Metal Shell
Back-to-Back
Page E-9



MLDM Back-To-Back Unshielded Cables

If a simple jumper cable is required, these cable assemblies simplify ordering. No special part numbers are necessary. Available in all sizes. Wiring is #1 to #1, etc. Back-to-backs are built to order in any length

MLDM Metal Shell
Right Angle PCB
Page E-11



MLDM Metal Shell, Right Angle PCB

9 to 51 positions. High performance M83513 TwistPin contact system. Factory-installed contacts, non-removable and are encapsulated with epoxy. PCB terminal spacing is .100" x .100" for easy board fabrication. 3 Amp, 600 Vac, -55°C to +150°C.

MWDL Plastic
Shell Solder Cup
Page E-15



MWDL All-Plastic, Solder Cup

Available in 9 to 51 contacts. High performance M83513 TwistPin contact system, the MWDL all-plastic connector is an economical alternative to metal shell connectors. Gold-plated solder cups accept #24 – #30 AWG wire. 3 Amp, 600 Vac, -55°C to +150°C.

MWDL Plastic
Shell Pre-Wired
Page E-17



MWDL All-Plastic, Stranded Wire

These crimp-terminated pre-wired assemblies offer an alternative to the time-consuming job of soldering wires. #24 – #30 AWG wire size. 3 Amp, 600 Vac, -55°C to +150°C.

MWDL Plastic
Shell Solid Wire
Page E-19



MLDM All Plastic, Solid Wire

Pre-wired with #24 to #30 solid wire. Available in 9 to 51 positions. High performance M83513 TwistPin contact system. 3 Amp, 600 Vac, -55°C to +150°C.

MWDL Plastic
Low Profile
Back-to-Back
Page E-21



MWDL All-Plastic Low Profile Back-to-Back Jumper Cables

Factory-terminated, contacts crimped to wire and potted with epoxy. High performance gold-plated TwistPin contacts recessed into insulator top prevent damage. 9 to 51 contacts, 3 A., 600 Vac, -55°C to +150°C. IAW MIL-DTL-83513.

MWDL Plastic
Shell Right Angle
PCB
Page E-23

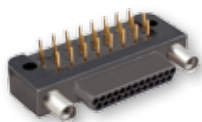

MWDL All-Plastic, Right Angle PCB

9 to 51 positions. High performance M83513 TwistPin contact system. Factory-installed gold-plated PC tails, non-removable and epoxy encapsulated. PCB terminal spacing is .100" x .100" for easy board fabrication. 3 Amp, 600 Vac, -55°C to +150°C.



Low Profile Metal and Plastic Shell Micro-D Product Information

MLDM

Low Profile Metal Shell Connector



MWDL

Low Profile All-Plastic Connector



- Metal Shell or One-Piece Plastic
- High Reliability TwistPin Contact System
- .050" Pitch Contact Spacing
- Solder Cup, Pre-Wired or PCB
- 3 Amps, +150°C, 600 Vac

E

Low Profile Metal Shell and Plastic Shell Micro-D's Save Space Compared to MWDM Metal Shell Connectors

Low profile MLDM metal shell and MWDL plastic shell connectors are intended for high reliability board-to-wire I/O and wire-to-wire applications. Gold-plated TwistPin contacts provide excellent performance when subjected to high levels of shock and vibration. Plastic and metal versions are interchangeable. Flange height is reduced by 33% compared to MWDM standard Micro-D connectors.

NOTE: Not interchangeable with Standard MWDM Interface

SIZE COMPARISON



MLDM 51 Pin Low Profile



MWDM 51 Pin Standard Height

Low Profile MLDM and MWDL Contact Arrangements

| | | | | |
|--|--|--|--|---|
| 1 2 3 4 5 6 7 8 9 | 1 2 3 4 5 6 7 8 9 10 11 12 13 14 15 | 1 2 3 4 5 6 7 8 9 10 11 12 13 14 15 16 17 18 19 20 21 | 1 2 3 4 5 6 7 8 9 10 11 12 13 14 15 16 17 18 19 20 21 22 23 24 25 | 1 2 3 4 5 6 7 8 9 10 11 12 13 14 15 16 17 18 19 20 21 22 23 24 25 26 27 28 29 30 31 |
| 9 | 15 | 21 | 25 | 31 |
| 1 2 3 4 5 6 7 8 9 10 11 12 13 14 15 16 17 18 19 20 21 22 23 24 25 26 27 28 29 30 31 32 33 34 35 36 37 | | 1 2 3 4 5 6 7 8 9 10 11 12 13 14 15 16 17 18 19 20 21 22 23 24 25 26 27 28 29 30 31 32 33 34 35 36 37 38 39 40 41 42 43 44 45 46 47 48 49 50 51 | | 1 2 3 4 5 6 7 8 9 10 11 12 13 14 15 16 17 18 19 20 21 22 23 24 25 26 27 28 29 30 31 32 33 34 35 36 37 38 39 40 41 42 43 44 45 46 47 48 49 50 51 |
| 37 | | 51-2 | | 51 |

Mating face of pin connector. Socket connector contact numbers are reversed.

| Materials and Finishes | |
|------------------------|--|
| Contacts | Copper alloy, 50 μm thick gold over nickel |
| Insulator, MWDL Body | Liquid crystal polymer (LCP) |
| MLDM Shell | Aluminum alloy |
| Mounting Hardware | Stainless Steel |
| Potting Compound | Epoxy |
| Insulated Wire | Per MIL-W-22759/11 and /33 |
| Solid Wire, PC Tails | Per A-A-59551, gold plated or tinned |

| Specifications | |
|---------------------------------|----------------------|
| Current Rating | 3 Amps |
| Contact Resistance | 8 milliohms maximum |
| Dielectric Withstanding Voltage | 600 Vac sea level |
| Insulation Resistance | 5000 megohms minimum |
| Operating Temperature | -55°C. to +150°C. |
| Shock | 50 g. |
| Vibration | 20 g. |

MLDM Low Profile Metal Shell Micro-D Solder Cup Contact Termination



Micro-D Double and Triple Row



Low profile MLDM connectors have reduced flange height compared to standard MWDM Micro-D connectors. These .050" pitch solder cup Micro-D connectors accept #26 to #30 gage wire with standard contacts and up to size #24 wire with "large bore" contacts. Contacts are factory-installed and potted with epoxy. Pin contacts are gold-plated high performance TwistPin type and are recessed into insulator to prevent damage. Socket contacts are gold plated, machined copper alloy. Machined aluminum shell. Glass-filled high temperature LCP thermoplastic insulators withstand soldering heat. Meets performance requirements of MIL-DTL-83513. Available with 9 to 51 contacts. 3 A., 600 Vac, -55°C to +150°C.

| How To Order Solder Cup Connector | | | | | |
|-----------------------------------|---|---|------------|-----------|----------|
| Sample Part Number | | MLDM2L | -25 | PS | B |
| Series | <p>MLDM1L Low Profile Metal Shell Micro-D with Yellow Chromate over Cadmium Shell Finish (Good corrosion protection, not RoHS compliant)</p> <p>MLDM2L Low Profile Metal Shell Micro-D with Electroless Nickel Shell Finish (RoHS compliant, preferred for space vehicles and protected environments)</p> | <p>MLDM32L Low Profile Metal Shell Micro-D with Black Zinc Nickel Shell Finish (RoHS compliant, preferred for tactical equipment where a black finish and good corrosion protection are required)</p> <p>MLDM33L Low Profile Metal Shell Micro-D with Nickel-Fluorocarbon Shell Finish (RoHS compliant, excellent corrosion protection, grey color)</p> | | | |
| Contact Layout | 9, 15, 21, 25, 31, 37, 51, 51-2 (See Table II) | | | | |
| Contact Type | Size #26 Solder Cup Contacts (Standard) PS, - Pin SS, - Socket Size #24 Solder Cup Contacts TS, - Socket NS, - Pin | | | | |
| Mounting Hardware | B, P, M, M1, S, S1, L, K, F, R, H (See Table I) | | | | |

| Table I: Mounting Hardware | | | | | | | | | | |
|----------------------------|----------|--------------------|------------------------------|---------------------|-------------------------------|----------------------------------|--|--------------------------------------|-------------------------------------|-----------------|
| B | P | M | M1 | S | S1 | L | K | F | R | H |
| | | | | | | | | | | |
| Thru-Hole | Jackpost | Hex Head Jackscrew | Hex Head Jackscrew, Extended | Slot Head Jackscrew | Slot Head Jackscrew, Extended | Hex Head Jackscrew Non-Removable | Slot Head Jackscrew Non-Removable Extended | Float Mount For Front Panel Mounting | Float Mount For Rear Panel Mounting | Threaded Insert |



MLDM Low Profile Metal Shell Micro-D Solder Cup Contact Termination

Table II: Dimensions



| Layout | A Max. | | B | | C Max. | | D Max. | | E Max. | | F | | G Max. | | H Max. | | J Max. | |
|--------------|--------|-------|--------------|--------------|--------|-------|--------|------|--------|------|--------------|--------------|--------|------|--------|------|--------|-------|
| | In. | mm. | In. ±.003 | mm. ±0.08 | In. | mm. | In. | mm. | In. | mm. | In. ±.003 | mm. ±0.08 | In. | mm. | In. | mm. | In. | mm. |
| 9P | .788 | 20.02 | .565 | 14.35 | .292 | 7.42 | .134 | 3.40 | .218 | 5.54 | .199 | 5.05 | .390 | 9.91 | .175 | 4.45 | .405 | 10.29 |
| 9S | .788 | 20.02 | .565 | 14.35 | .380 | 9.65 | .218 | 5.54 | .218 | 5.54 | .180 | 4.57 | .377 | 9.58 | .175 | 4.45 | .405 | 10.29 |
| 15P | .938 | 23.83 | .715 | 18.16 | .442 | 11.23 | .134 | 3.40 | .218 | 5.54 | .199 | 5.05 | .390 | 9.91 | .175 | 4.45 | .555 | 14.10 |
| 15S | .938 | 23.83 | .715 | 18.16 | .530 | 13.46 | .218 | 5.54 | .218 | 5.54 | .180 | 4.57 | .377 | 9.58 | .175 | 4.45 | .555 | 14.10 |
| 21P | 1.088 | 27.64 | .865 | 21.97 | .592 | 15.04 | .134 | 3.40 | .218 | 5.54 | .199 | 5.05 | .390 | 9.91 | .175 | 4.45 | .705 | 17.91 |
| 21S | 1.080 | 27.64 | .865 | 21.97 | .680 | 17.27 | .218 | 5.54 | .218 | 5.54 | .180 | 4.57 | .377 | 9.58 | .175 | 4.45 | .705 | 17.91 |
| 25P | 1.188 | 30.18 | .965 | 24.51 | .692 | 17.58 | .134 | 3.40 | .218 | 5.54 | .199 | 5.05 | .390 | 9.91 | .175 | 4.45 | .805 | 20.45 |
| 25S | 1.185 | 30.18 | .965 | 24.51 | .780 | 19.81 | .218 | 5.54 | .218 | 5.54 | .180 | 4.57 | .377 | 9.58 | .175 | 4.45 | .805 | 20.45 |
| 31P | 1.338 | 33.99 | 1.115 | 28.32 | .842 | 21.39 | .134 | 3.40 | .218 | 5.54 | .199 | 5.05 | .390 | 9.91 | .175 | 4.45 | .955 | 24.26 |
| 31S | 1.338 | 33.99 | 1.115 | 28.32 | .930 | 23.62 | .218 | 5.54 | .218 | 5.54 | .180 | 4.57 | .377 | 9.58 | .175 | 4.45 | .955 | 24.26 |
| 37P | 1.488 | 37.80 | 1.265 | 32.13 | .992 | 25.20 | .134 | 3.40 | .218 | 5.54 | .199 | 5.05 | .390 | 9.91 | .175 | 4.45 | 1.105 | 28.07 |
| 37S | 1.488 | 37.80 | 1.265 | 32.13 | 1.080 | 27.43 | .218 | 5.54 | .218 | 5.54 | .180 | 4.57 | .377 | 9.58 | .175 | 4.45 | 1.105 | 28.07 |
| 51P | 1.438 | 36.53 | 1.215 | 30.86 | .942 | 23.93 | .177 | 4.50 | .260 | 6.60 | .199 | 5.05 | .390 | 9.91 | .220 | 5.59 | 1.058 | 26.87 |
| 51S | 1.438 | 36.53 | 1.215 | 30.86 | 1.030 | 26.16 | .260 | 6.60 | .260 | 6.60 | .180 | 4.57 | .377 | 9.58 | .220 | 5.59 | 1.058 | 26.87 |
| 51-2P | 1.835 | 46.61 | 1.615 | 41.02 | 1.340 | 34.04 | .134 | 3.40 | .218 | 5.54 | .199 | 5.05 | .390 | 9.91 | .175 | 4.45 | 1.455 | 36.96 |
| 51-2S | 1.835 | 46.61 | 1.615 | 41.02 | 1.425 | 36.20 | .218 | 5.54 | .218 | 5.54 | .180 | 4.57 | .377 | 9.58 | .175 | 4.45 | 1.455 | 36.96 |

E

MLDM Low Profile Metal Shell Micro-D Insulated Wire Termination



Micro-D Double and Triple Row



Low profile MLDM connectors have reduced flange height compared to standard MWDM Micro-D connectors. These .050" pitch Micro-D connectors are supplied with stranded mil spec hookup wire. Contacts are crimped to wire and potted with epoxy. Pin contacts are gold-plated high performance TwistPin type and are recessed into insulator to prevent damage. Socket contacts are gold plated, machined copper alloy. Machined aluminum shell. Glass-filled high temperature LCP thermoplastic insulators. M22759/11 standard wire, or M22959/33 lightweight, high strength space grade wire. Meets performance requirements of MIL-DTL-83513. Available with 9 to 51 contacts. 3 A., 600 Vac, -55°C to +150°C.

| How To Order Insulated Wire Connector | |
|---------------------------------------|---|
| Sample Part Number | MLDM2L -31 P -6 K 5 -18 M |
| Series | <p>MLDM1L Low Profile Metal Shell Micro-D With Yellow Chromate Over Cadmium Finish</p> <p>MLDM2L Low Profile Metal Shell Micro-D With Electroless Nickel Shell Finish</p> <p>MLDM32L Low Profile Metal Shell Micro-D With Black Zinc Nickel Shell Finish</p> <p>MLDM33L Low Profile Metal Shell Micro-D With Nickel-Fluorocarbon Shell Finish</p> |
| Contact Layout | 9, 15, 21, 25, 31, 37, 51, 51-2 (See Table II) |
| Contact Type | P - Pin S - Socket |
| Wire Gage (AWG) | 4 - #24 6 - #26 8 - #28 0 - #30 (J wire type only) |
| Wire Type | <p>K Standard Wire Extruded PTFE per M22759/11, Silver-Plated Conductors</p> <p>J Space Grade Wire High Strength, Lightweight, Crosslinked Modified ETFE per M22759/33, Silver-Plated Conductors</p> |
| Wire color Code | 1 - White 5 - Color-Coded per MIL-STD-681 7 - 10 Color Repeat (Wires are solid color per MIL-STD-681 color code system.) |
| Wire Length | Wire Length In Inches Example: 18 = 18 inches; |
| Mounting Hardware | B, M, M1, S, S1, L, F, H, P, K, R |

| Table I: Mounting Hardware | | | | | | | | | | |
|----------------------------|----------------|--------------------------|------------------------------------|---------------------------|-------------------------------------|--|--|--------------------------------------|-------------------------------------|-----------------------|
| B | P | M | M1 | S | S1 | L | K | F | R | H |
| | | | | | | | | | | |
| Thru-Hole | Jackpost #2-56 | Hex Head Jackscrew #2-56 | Hex Head Jackscrew, Extended #2-56 | Slot Head Jackscrew #2-56 | Slot Head Jackscrew, Extended #2-56 | Hex Head Jackscrew Non-Removable #2-56 | Slot Head Jackscrew Non-Removable Extended #2-56 | Float Mount For Front Panel Mounting | Float Mount For Rear Panel Mounting | Threaded Insert #2-56 |



MLDM Low Profile Metal Shell Micro-D Insulated Wire Termination

Table II: Dimensions



E

| Layout | A Max. | | B | | C Max. | | D Max. | | E Max. | | F | | G Max. | | H Max. | | J Max. | |
|--------------|--------|-------|--------------|--------------|--------|-------|--------|------|--------|------|--------------|--------------|--------|------|--------|------|--------|-------|
| | In. | mm. | In. ±.003 | mm. ±0.08 | In. | mm. | In. | mm. | In. | mm. | In. ±.003 | mm. ±0.08 | In. | mm. | In. | mm. | In. | mm. |
| 9P | .788 | 20.02 | .565 | 14.35 | .292 | 7.42 | .134 | 3.40 | .218 | 5.54 | .199 | 5.05 | .390 | 9.91 | .175 | 4.45 | .405 | 10.29 |
| 9S | .788 | 20.02 | .565 | 14.35 | .380 | 9.65 | .218 | 5.54 | .218 | 5.54 | .180 | 4.57 | .377 | 9.58 | .175 | 4.45 | .405 | 10.29 |
| 15P | .938 | 23.83 | .715 | 18.16 | .442 | 11.23 | .134 | 3.40 | .218 | 5.54 | .199 | 5.05 | .390 | 9.91 | .175 | 4.45 | .555 | 14.10 |
| 15S | .938 | 23.83 | .715 | 18.16 | .530 | 13.46 | .218 | 5.54 | .218 | 5.54 | .180 | 4.57 | .377 | 9.58 | .175 | 4.45 | .555 | 14.10 |
| 21P | 1.088 | 27.64 | .865 | 21.97 | .592 | 15.04 | .134 | 3.40 | .218 | 5.54 | .199 | 5.05 | .390 | 9.91 | .175 | 4.45 | .705 | 17.91 |
| 21S | 1.080 | 27.64 | .865 | 21.97 | .680 | 17.27 | .218 | 5.54 | .218 | 5.54 | .180 | 4.57 | .377 | 9.58 | .175 | 4.45 | .705 | 17.91 |
| 25P | 1.188 | 30.18 | .965 | 24.51 | .692 | 17.58 | .134 | 3.40 | .218 | 5.54 | .199 | 5.05 | .390 | 9.91 | .175 | 4.45 | .805 | 20.45 |
| 25S | 1.185 | 30.18 | .965 | 24.51 | .780 | 19.81 | .218 | 5.54 | .218 | 5.54 | .180 | 4.57 | .377 | 9.58 | .175 | 4.45 | .805 | 20.45 |
| 31P | 1.338 | 33.99 | 1.115 | 28.32 | .842 | 21.39 | .134 | 3.40 | .218 | 5.54 | .199 | 5.05 | .390 | 9.91 | .175 | 4.45 | .955 | 24.26 |
| 31S | 1.338 | 33.99 | 1.115 | 28.32 | .930 | 23.62 | .218 | 5.54 | .218 | 5.54 | .180 | 4.57 | .377 | 9.58 | .175 | 4.45 | .955 | 24.26 |
| 37P | 1.488 | 37.80 | 1.265 | 32.13 | .992 | 25.20 | .134 | 3.40 | .218 | 5.54 | .199 | 5.05 | .390 | 9.91 | .175 | 4.45 | 1.105 | 28.07 |
| 37S | 1.488 | 37.80 | 1.265 | 32.13 | 1.080 | 27.43 | .218 | 5.54 | .218 | 5.54 | .180 | 4.57 | .377 | 9.58 | .175 | 4.45 | 1.105 | 28.07 |
| 51P | 1.438 | 36.53 | 1.215 | 30.86 | .942 | 23.93 | .177 | 4.50 | .260 | 6.60 | .199 | 5.05 | .390 | 9.91 | .220 | 5.59 | 1.058 | 26.87 |
| 51S | 1.438 | 36.53 | 1.215 | 30.86 | 1.030 | 26.16 | .260 | 6.60 | .260 | 6.60 | .180 | 4.57 | .377 | 9.58 | .220 | 5.59 | 1.058 | 26.87 |
| 51-2P | 1.835 | 46.61 | 1.615 | 41.02 | 1.340 | 34.04 | .134 | 3.40 | .218 | 5.54 | .199 | 5.05 | .390 | 9.91 | .175 | 4.45 | 1.455 | 36.96 |
| 51-2S | 1.835 | 46.61 | 1.615 | 41.02 | 1.425 | 36.20 | .218 | 5.54 | .218 | 5.54 | .180 | 4.57 | .377 | 9.58 | .175 | 4.45 | 1.455 | 36.96 |

MLDM Low Profile Metal Shell Micro-D Solid Wire Termination



Micro-D Double and Triple Row



Low profile MLDM connectors have reduced flange height compared to standard MWDM Micro-D connectors. These .050" pitch Micro-D connectors are supplied with solid copper wire. Contacts are crimped to wire and potted with epoxy. Pin contacts are gold-plated high performance TwistPin type and are recessed into insulator to prevent damage. Socket contacts are gold plated, machined copper alloy. Machined aluminum shell. Glass-filled high temperature LCP thermoplastic insulators. Meets performance requirements of MIL-DTL-83513. Available with 9 to 51 contacts. 3 A., 600 Vac, -55°C to +150°C.

How To Order Solid Wire Connector

| Sample Part Number | MLDM2L | -31 | S | -4 | C | 4 | -.250 | B |
|--------------------|--|--|---|----|---|---|-------|---|
| Series | MLDM1L Low Profile Metal Shell Micro-D With Yellow Chromate Over Cadmium Finish MLDM32L Low Profile Metal Shell Micro-D With Black Zinc Nickel Shell Finish | MLDM2L Low Profile Metal Shell Micro-D With Electroless Nickel Shell Finish MLDM33L Low Profile Metal Shell Micro-D With Nickel-Fluorocarbon Shell Finish | | | | | | |
| Contact Layout | 9, 15, 21, 25, 31, 37, 51, 51-2, | | | | | | | |
| Contact Type | P - Pin S - Socket | | | | | | | |
| Wire Gage (AWG) | 4 - #24 5 - #25 6 - #26 | | | | | | | |
| Wire Type | C - Solid Copper | | | | | | | |
| Wire Finish | 3 - Solder Dipped (Sn60/Pb40) 4 - Gold-plated | | | | | | | |
| Wire Length | Wire Length In Inches .125, .250, .500, 1.000, 1.500, 2.000 | | | | | | | |
| Mounting Hardware | B, M, M1, S, S1, L, F, H, P, K, R, | | | | | | | |

E

Table I: Mounting Hardware

| B | P | M | M1 | S | S1 | L | K | F | R | H |
|-----------|----------------|--------------------------|------------------------------------|---------------------------|-------------------------------------|--|--|--------------------------------------|-------------------------------------|-----------------------|
| | | | | | | | | | | |
| Thru-Hole | Jackpost #2-56 | Hex Head Jackscrew #2-56 | Hex Head Jackscrew, Extended #2-56 | Slot Head Jackscrew #2-56 | Slot Head Jackscrew, Extended #2-56 | Hex Head Jackscrew Non-Removable #2-56 | Slot Head Jackscrew Non-Removable Extended #2-56 | Float Mount For Front Panel Mounting | Float Mount For Rear Panel Mounting | Threaded Insert #2-56 |



MLDM Low Profile Metal Shell Micro-D Solid Wire Termination

Table II: Dimensions



E

| Layout | A Max. | | B | | C Max. | | D Max. | | E Max. | | F | | G Max. | | H Max. | | J Max. | |
|--------|--------|-------|--------------|---------------|--------|-------|--------|------|--------|------|--------------|---------------|--------|------|--------|------|--------|-------|
| | In. | mm. | In. ±.003 | mm. ± 0.08 | In. | mm. | In. | mm. | In. | mm. | In. ±.003 | mm. ± 0.08 | In. | mm. | In. | mm. | In. | mm. |
| 9P | .788 | 20.02 | .565 | 14.35 | .292 | 7.42 | .134 | 3.40 | .218 | 5.54 | .199 | 5.05 | .390 | 9.91 | .175 | 4.45 | .405 | 10.29 |
| 9S | .788 | 20.02 | .565 | 14.35 | .380 | 9.65 | .218 | 5.54 | .218 | 5.54 | .180 | 4.57 | .377 | 9.58 | .175 | 4.45 | .405 | 10.29 |
| 15P | .938 | 23.83 | .715 | 18.16 | .442 | 11.23 | .134 | 3.40 | .218 | 5.54 | .199 | 5.05 | .390 | 9.91 | .175 | 4.45 | .555 | 14.10 |
| 15S | .938 | 23.83 | .715 | 18.16 | .530 | 13.46 | .218 | 5.54 | .218 | 5.54 | .180 | 4.57 | .377 | 9.58 | .175 | 4.45 | .555 | 14.10 |
| 21P | 1.088 | 27.64 | .865 | 21.97 | .592 | 15.04 | .134 | 3.40 | .218 | 5.54 | .199 | 5.05 | .390 | 9.91 | .175 | 4.45 | .705 | 17.91 |
| 21S | 1.080 | 27.64 | .865 | 21.97 | .680 | 17.27 | .218 | 5.54 | .218 | 5.54 | .180 | 4.57 | .377 | 9.58 | .175 | 4.45 | .705 | 17.91 |
| 25P | 1.188 | 30.18 | .965 | 24.51 | .692 | 17.58 | .134 | 3.40 | .218 | 5.54 | .199 | 5.05 | .390 | 9.91 | .175 | 4.45 | .805 | 20.45 |
| 25S | 1.185 | 30.18 | .965 | 24.51 | .780 | 19.81 | .218 | 5.54 | .218 | 5.54 | .180 | 4.57 | .377 | 9.58 | .175 | 4.45 | .805 | 20.45 |
| 31P | 1.338 | 33.99 | 1.115 | 28.32 | .842 | 21.39 | .134 | 3.40 | .218 | 5.54 | .199 | 5.05 | .390 | 9.91 | .175 | 4.45 | .955 | 24.26 |
| 31S | 1.338 | 33.99 | 1.115 | 28.32 | .930 | 23.62 | .218 | 5.54 | .218 | 5.54 | .180 | 4.57 | .377 | 9.58 | .175 | 4.45 | .955 | 24.26 |
| 37P | 1.488 | 37.80 | 1.265 | 32.13 | .992 | 25.20 | .134 | 3.40 | .218 | 5.54 | .199 | 5.05 | .390 | 9.91 | .175 | 4.45 | 1.105 | 28.07 |
| 37S | 1.488 | 37.80 | 1.265 | 32.13 | 1.080 | 27.43 | .218 | 5.54 | .218 | 5.54 | .180 | 4.57 | .377 | 9.58 | .175 | 4.45 | 1.105 | 28.07 |
| 51P | 1.438 | 36.53 | 1.215 | 30.86 | .942 | 23.93 | .177 | 4.50 | .260 | 6.60 | .199 | 5.05 | .390 | 9.91 | .220 | 5.59 | 1.058 | 26.87 |
| 51S | 1.438 | 36.53 | 1.215 | 30.86 | 1.030 | 26.16 | .260 | 6.60 | .260 | 6.60 | .180 | 4.57 | .377 | 9.58 | .220 | 5.59 | 1.058 | 26.87 |
| 51-2P | 1.835 | 46.61 | 1.615 | 41.02 | 1.340 | 34.04 | .134 | 3.40 | .218 | 5.54 | .199 | 5.05 | .390 | 9.91 | .175 | 4.45 | 1.455 | 36.96 |
| 51-2S | 1.835 | 46.61 | 1.615 | 41.02 | 1.425 | 36.20 | .218 | 5.54 | .218 | 5.54 | .180 | 4.57 | .377 | 9.58 | .175 | 4.45 | 1.455 | 36.96 |

MLDM Low Profile Metal Shell Micro-D Back-To-Back Cables



Micro-D Double and Triple Row



Factory terminated MLDM "back-to-back" jumper cables simplify ordering and reduce assembly labor. Contacts are crimped to wire and potted with epoxy. Pin contacts are gold-plated high performance TwistPin type and are recessed into insulator to prevent damage. Socket contacts are gold plated, machined copper alloy. Aluminum alloy shell. Glass-filled high temperature LCP thermoplastic insulator. M22759/11 standard wire, or M22959/33 lightweight, high strength space grade wire. Meets performance requirements of MIL-DTL-83513. Available with 9 to 51 contacts. 3 A., 600 VAC, -55°C to +150°C.

How To Order Back-to-Back Connector

| Sample Part Number | MLDM32L -37 GP -6 K 1 -18 P | | | | | | | | | |
|----------------------|---|--|--|--|--|--|--|--|--|--|
| Series | MLDM1L Low Profile Metal Shell Micro-D With Yellow Chromate Over Cadmium Finish MLDM32L Low Profile Metal Shell Micro-D With Black Zinc Nickel Shell Finish | | MLDM2L Low Profile Metal Shell Micro-D With Electroless Nickel Shell Finish MLDM33L Low Profile Metal Shell Micro-D With Nickel-Fluorocarbon Shell Finish | | | | | | | |
| Contact Layout | 9, 15, 21, 25, 31, 37, 51, 51-2 (See Table II) | | | | | | | | | |
| Contact Type | GP - Pin Connector Both Ends GS - Socket Contacts Both Ends CS - Pin Connector to Socket Connector | | | | | | | | | |
| Wire Gage (AWG) | 4 - #24 6 - #26 8 - #28 0 - #30 (J wire only) | | | | | | | | | |
| Wire Type | K - Standard Wire Extruded PTFE per M22759/11, Silver-Plated Conductors J - Space Grade Wire High Strength, Lightweight, Crosslinked Modified ETFE per M22759/33, Silver-Plated Conductors | | | | | | | | | |
| Wire Color Code | 1 - White 5 - Color-Coded per MIL-STD-681 7 - 10 color repeat wires are solid color per MIL-STD-681 color code system. | | | | | | | | | |
| Wire Length (inches) | 18 - 18 inches (2" minimum for 2 rows, 3" minimum for 3 rows). | | | | | | | | | |
| Mounting Hardware | B, M, M1, S, S1, L, F, H, P, K, R (See Table I) | | | | | | | | | |

E

Table I: Mounting Hardware

| B | P | M | M1 | S | S1 | L | K | F | R | H |
|-----------|----------------|--------------------------|------------------------------------|---------------------------|-------------------------------------|--|--|--------------------------------------|-------------------------------------|-----------------------|
| | | | | | | | | | | |
| Thru-Hole | Jackpost #2-56 | Hex Head Jackscrew #2-56 | Hex Head Jackscrew, Extended #2-56 | Slot Head Jackscrew #2-56 | Slot Head Jackscrew, Extended #2-56 | Hex Head Jackscrew Non-Removable #2-56 | Slot Head Jackscrew Non-Removable Extended #2-56 | Float Mount For Front Panel Mounting | Float Mount For Rear Panel Mounting | Threaded Insert #2-56 |



MLDM Low Profile Metal Shell Micro-D Back-To-Back Cables

Table II: Dimensions



| Layout | A Max. | | B | | C Max. | | D Max. | | E Max. | | F Max. | | G Max. | | H Max. | | J Max. | |
|--------|--------|-------|-------------------|-------------------|--------|-------|--------|------|--------|------|--------|-------|--------|-------|--------|------|--------|------|
| | In. | mm. | In. $\pm .003$ | mm. ± 0.08 | In. | mm. | In. | mm. | In. | mm. | In. | mm. | In. | mm. | In. | mm. | In. | mm. |
| 9P | .788 | 20.02 | .565 | 14.35 | .292 | 7.42 | .218 | 5.54 | .202 | 5.13 | .395 | 10.03 | .408 | 10.36 | .173 | 4.39 | .134 | 3.40 |
| 9S | .788 | 20.02 | .565 | 14.35 | .380 | 9.65 | .218 | 5.54 | .185 | 4.70 | .375 | 9.53 | .408 | 10.36 | .173 | 4.39 | .218 | 5.54 |
| 15P | .938 | 23.83 | .715 | 18.16 | .442 | 11.23 | .218 | 5.54 | .202 | 5.13 | .395 | 10.03 | .558 | 14.17 | .173 | 4.39 | .134 | 3.40 |
| 15S | .938 | 23.83 | .715 | 18.16 | .530 | 13.46 | .218 | 5.54 | .185 | 4.70 | .375 | 9.53 | .558 | 14.17 | .173 | 4.39 | .218 | 5.64 |
| 21P | 1.088 | 27.64 | .865 | 21.97 | .592 | 15.04 | .218 | 5.54 | .202 | 5.13 | .395 | 10.03 | .708 | 17.98 | .173 | 4.39 | .134 | 3.40 |
| 21S | 1.080 | 27.64 | .865 | 21.97 | .680 | 17.27 | .218 | 5.54 | .185 | 4.70 | .375 | 9.53 | .708 | 17.98 | .173 | 4.39 | .218 | 5.64 |
| 25P | 1.188 | 30.18 | .965 | 24.51 | .692 | 17.58 | .218 | 5.54 | .202 | 5.13 | .395 | 10.03 | .808 | 20.52 | .173 | 4.39 | .134 | 3.40 |
| 25S | 1.185 | 30.18 | .965 | 24.51 | .780 | 19.81 | .218 | 5.54 | .185 | 4.70 | .375 | 9.53 | .808 | 20.52 | .173 | 4.39 | .218 | 5.64 |
| 31P | 1.338 | 33.99 | 1.115 | 28.32 | .842 | 21.39 | .218 | 5.54 | .202 | 5.13 | .395 | 10.03 | .958 | 24.33 | .173 | 4.39 | .134 | 3.40 |
| 31S | 1.338 | 33.99 | 1.115 | 28.32 | .930 | 23.62 | .218 | 5.54 | .185 | 4.70 | .375 | 9.53 | .958 | 24.33 | .173 | 4.39 | .218 | 5.64 |
| 37P | 1.488 | 37.80 | 1.265 | 32.13 | .992 | 25.20 | .218 | 5.54 | .202 | 5.13 | .395 | 10.03 | 1.108 | 28.14 | .173 | 4.39 | .134 | 3.40 |
| 37S | 1.488 | 37.80 | 1.265 | 32.13 | 1.080 | 27.43 | .218 | 5.54 | .185 | 4.70 | .375 | 9.53 | 1.108 | 28.14 | .173 | 4.39 | .218 | 5.64 |
| 51P | 1.438 | 36.53 | 1.215 | 30.86 | .942 | 23.93 | .260 | 6.60 | .202 | 5.13 | .395 | 10.03 | 1.058 | 26.87 | .220 | 5.59 | .177 | 4.50 |
| 51S | 1.438 | 36.53 | 1.215 | 30.86 | 1.030 | 26.16 | .260 | 6.60 | .185 | 4.70 | .375 | 9.53 | 1.058 | 26.87 | .220 | 5.59 | .260 | 6.60 |
| 51-2P | 1.835 | 46.61 | 1.615 | 41.02 | 1.340 | 34.04 | .218 | 5.54 | .214 | 5.44 | .199 | 5.05 | .390 | 9.91 | .175 | 4.45 | .134 | 3.40 |
| 51-2S | 1.835 | 46.61 | 1.615 | 41.02 | 1.425 | 36.20 | .218 | 5.54 | .214 | 5.44 | .180 | 4.57 | .377 | 9.58 | .175 | 4.45 | .218 | 5.54 |

MLDM Low Profile Metal Shell Micro-D Right Angle PCB Termination



Micro-D Double
and Triple Row



MLDM2L-25SCBRPT-110

Low profile MLDM connectors have reduced flange height compared to standard MWDM Micro-D connectors. These thru-hole "CBR" style Micro-D connectors have gold-plated PC tails on .100" centers. Connectors are backfilled with epoxy. Pin contacts are gold-plated high performance TwistPin type and are recessed into insulator to prevent damage. Socket contacts are gold plated, machined copper alloy. Gold-plated PC tails. Machined aluminum shell, stainless steel hardware. Optional #2-56 threaded inserts in board mounting holes. Glass-filled LCP thermoplastic insulators and tray withstand immersion in +260°C solder for 10 seconds. Meets performance requirements of MIL-DTL-83513. Available with 9 to 51 contacts. 3 A., 600 Vac, -55°C to +150°C.

How To Order Right Angle PCB Connector

| Sample Part Number | MLDM2L | -21 | S | CBR | P | T | -110 | -513 |
|-------------------------------|--|-----|---|-----|---|---|------|------|
| Series | MLDM1L Low Profile Metal Shell Micro-D With Yellow Chromate Over Cadmium Finish MLDM32L Low Profile Metal Shell Micro-D With Black Zinc Nickel Shell Finish MLDM2L Low Profile Metal Shell Micro-D With Electroless Nickel Shell Finish MLDM33L Low Profile Metal Shell Micro-D With Nickel-Fluorocarbon Shell Finish | | | | | | | |
| Contact Layout | 9, 15, 21, 25, 31, 37, 51 (See Table II) | | | | | | | |
| Contact Type | P - Pin Contacts S - Socket Contacts | | | | | | | |
| Termination Type | CBR - Condensed Board Right Angle | | | | | | | |
| Hardware Option | (Omit for None) Jackposts for Rear Panel Mounting P - Jackpost R1 - .032" Panel R2 - .047" Panel R3 - .062" Panel (See Table I) R4 - .093" Panel R5 - .125" Panel R6 - .125" Panel | | | | | | | |
| Threaded Insert Option | Omit - For Thru-Holes T - Threaded Inserts in Board Mounting Holes. #2-56 Female Thread. M - Threaded Inserts in Board Mounting Holes. M2 Metric Thread. | | | | | | | |
| PC Tail Length | -110, -125, -150, -190, -250 | | | | | | | |
| Gold-Plated Terminal Mod Code | Omit - These connectors are solder-dipped in 60/40 tin lead solder. To delete the solder dip and change to gold-plated terminal add code 513 | | | | | | | |

E

Table I: Jackpost Options

| No Designator | P | R1 Thru R6 |
|---|---|---|
| <p>THREADED INSERT</p> | | <p>Panel</p> |
| Thru-Hole For use with Glenair jackposts only. Order hardware separately. Install with threadlocking compound. | Standard Jackpost Factory installed, not intended for removal. | Jackpost for Rear Panel Mounting Shipped loosely installed. Install with permanent threadlocking compound. |



MLDM Low Profile Metal Shell Micro-D Right Angle PCB Termination

Table II: Dimensions



| Layout | A Max. | | B | | C Max. | | D Max. | | E | | F Max. | | G Max. | | H | | J Max. | |
|--------|--------|-------|--------------|--------------|--------|-------|--------|------|------|------|--------|-------|--------|------|--------------|--------------|--------|------|
| | In. | mm. | In. ±.003 | mm. ±0.08 | In. | mm. | In. | mm. | In. | mm. | In. | mm. | In. | mm. | In. ±.010 | mm. ±0.25 | In. | mm. |
| 9P | .788 | 20.02 | .565 | 14.35 | .292 | 7.42 | .218 | 5.54 | .250 | 6.35 | .425 | 10.80 | .202 | 5.13 | .230 | 5.84 | .134 | 3.40 |
| 9S | .788 | 20.02 | .565 | 14.35 | .380 | 9.65 | .218 | 5.54 | .250 | 6.35 | .425 | 10.80 | .185 | 4.70 | .230 | 5.84 | .218 | 5.54 |
| 15P | .938 | 23.83 | .715 | 18.16 | .442 | 11.23 | .218 | 5.54 | .250 | 6.35 | .425 | 10.80 | .202 | 5.13 | .130 | 3.30 | .134 | 3.40 |
| 15S | .938 | 23.83 | .715 | 18.16 | .530 | 13.46 | .218 | 5.54 | .250 | 6.35 | .425 | 10.80 | .185 | 4.70 | .130 | 3.30 | .218 | 5.64 |
| 21P | 1.088 | 27.64 | .865 | 21.97 | .592 | 15.04 | .218 | 5.54 | .250 | 6.35 | .425 | 10.80 | .202 | 5.13 | .130 | 3.30 | .134 | 3.40 |
| 21S | 1.080 | 27.64 | .865 | 21.97 | .680 | 17.27 | .218 | 5.54 | .250 | 6.35 | .425 | 10.80 | .185 | 4.70 | .130 | 3.30 | .218 | 5.64 |
| 25P | 1.188 | 30.18 | .965 | 24.51 | .692 | 17.58 | .218 | 5.54 | .250 | 6.35 | .425 | 10.80 | .202 | 5.13 | .130 | 3.30 | .134 | 3.40 |
| 25S | 1.185 | 30.18 | .965 | 24.51 | .780 | 19.81 | .218 | 5.54 | .250 | 6.35 | .425 | 10.80 | .185 | 4.70 | .130 | 3.30 | .218 | 5.64 |
| 31P | 1.338 | 33.99 | 1.115 | 28.32 | .842 | 21.39 | .218 | 5.54 | .250 | 6.35 | .525 | 13.34 | .202 | 5.13 | .130 | 3.30 | .134 | 3.40 |
| 31S | 1.338 | 33.99 | 1.115 | 28.32 | .930 | 23.62 | .218 | 5.54 | .250 | 6.35 | .525 | 13.34 | .185 | 4.70 | .130 | 3.30 | .218 | 5.64 |
| 37P | 1.488 | 37.80 | 1.265 | 32.13 | .992 | 25.20 | .218 | 5.54 | .250 | 6.35 | .525 | 13.34 | .202 | 5.13 | .130 | 3.30 | .134 | 3.40 |
| 37S | 1.488 | 37.80 | 1.265 | 32.13 | 1.080 | 27.43 | .218 | 5.54 | .250 | 6.35 | .525 | 13.34 | .185 | 4.70 | .130 | 3.30 | .218 | 5.64 |
| 51P | 1.438 | 36.53 | 1.215 | 30.86 | .942 | 23.93 | .260 | 6.60 | .300 | 7.62 | .660 | 16.76 | .202 | 5.13 | .150 | 3.81 | .177 | 4.50 |
| 51S | 1.438 | 36.53 | 1.215 | 30.86 | 1.030 | 26.16 | .260 | 6.60 | .300 | 7.62 | .660 | 16.76 | .185 | 4.70 | .150 | 3.81 | .260 | 6.60 |

MLDM Low Profile Metal Shell Micro-D Right Angle PCB Termination



Micro-D Double
and Triple Row

MLDM CBR PCB Layouts — Pin Connectors



9 PIN



25 PIN



15 PIN



31 PIN



21 PIN



37 PIN

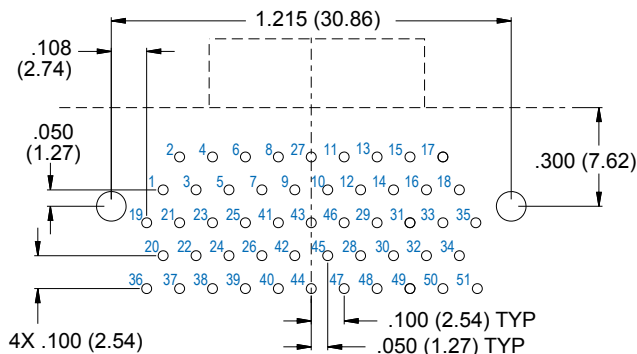

51 PIN

Notes

1. Patterns shown are for connector mounting side of PCB board.
2. Board mounting holes are .094" (2.39) diameter.
3. PC tails are .022" (0.56) maximum diameter.

E



MLDM Low Profile Metal Shell Micro-D Right Angle PCB Termination

MLDM CBR PCB Layouts — Socket Connectors



9 Socket



25 Socket



15 Socket



31 Socket



21 Socket



37 Socket



51 Socket

Notes

1. Patterns shown are for connector mounting side of PC board.
2. Board mounting holes are .094" (2.39) diameter.
3. PC tails are .022" (0.56) maximum diameter.

E

MWDL Low Profile Plastic Shell Micro-D Solder Cup Termination



Micro-D Double
and Triple Row



These .050" pitch all-plastic solder cup Micro-D connectors accept #26 to #30 gage wire with standard contacts and up to size #24 wire with "large bore" contacts. Contacts are factory-installed and potted with epoxy. Pin contacts are gold-plated high performance TwistPin type and are recessed into insulator to prevent damage. Socket contacts are gold plated, machined copper alloy. Glass-filled high temperature thermoplastic insulators withstand soldering heat. Meets performance requirements of MIL-DTL-83513, Class P. Available with 9 to 51 contacts. 3 A., 600 Vac, -55°C to +150°C.

How To Order Solder Cup Connector

| | | | | |
|---------------------------|--|---|-----------|----------|
| Sample Part Number | MWDL | -25 | SS | B |
| Series | MWDL - Low Profile Plastic Shell Micro-D | | | |
| Contact Layout | 9, 15, 21, 25, 31, 37, 51 (See Table II) | | | |
| Contact Type | Size #26 Solder Cup Contacts (Standard) PS - Pin SS - Socket | Size #24 Solder Cup Contacts NS - Pin TS - Socket | | |
| Mounting Hardware | B, P, M, M1, S, S1 (See Table I) | | | |

E

Table I: Mounting Hardware

| B | P | M | M1 | S | S1 |
|-----------|-------------------|-----------------------------|---------------------------------------|------------------------------|--|
| | | | | | |
| Thru-Hole | Jackpost #2-56 | Hex Head Jackscrew #2-56 | Hex Head Jackscrew, Extended #2-56 | Slot Head Jackscrew #2-56 | Slot Head Jackscrew, Extended #2-56 |



MWDL Low Profile Plastic Shell Micro-D Solder Cup Termination

Table II: Dimensions



| Layout | A Max. | | B | | C Max. | | D Max. | | E Max. | | F Max. | | G Max. | | H Max. | | J Max. | |
|------------|--------|-------|---------------|---------------|--------|-------|--------|------|--------|------|--------|-------|--------|-------|--------|------|--------|------|
| | In. | mm. | In. ± .003 | mm. ± 0.08 | In. | mm. | In. | mm. | In. | mm. | In. | mm. | In. | mm. | In. | mm. | In. | mm. |
| 9P | .788 | 20.02 | .565 | 14.35 | .292 | 7.42 | .218 | 5.54 | .202 | 5.13 | .395 | 10.03 | .408 | 10.36 | .173 | 4.39 | .134 | 3.40 |
| 9S | .788 | 20.02 | .565 | 14.35 | .380 | 9.65 | .218 | 5.54 | .185 | 4.70 | .375 | 9.53 | .408 | 10.36 | .173 | 4.39 | .218 | 5.54 |
| 15P | .938 | 23.83 | .715 | 18.16 | .442 | 11.23 | .218 | 5.54 | .202 | 5.13 | .395 | 10.03 | .558 | 14.17 | .173 | 4.39 | .134 | 3.40 |
| 15S | .938 | 23.83 | .715 | 18.16 | .530 | 13.46 | .218 | 5.54 | .185 | 4.70 | .375 | 9.53 | .558 | 14.17 | .173 | 4.39 | .218 | 5.64 |
| 21P | 1.088 | 27.64 | .865 | 21.97 | .592 | 15.04 | .218 | 5.54 | .202 | 5.13 | .395 | 10.03 | .708 | 17.98 | .173 | 4.39 | .134 | 3.40 |
| 21S | 1.080 | 27.64 | .865 | 21.97 | .680 | 17.27 | .218 | 5.54 | .185 | 4.70 | .375 | 9.53 | .708 | 17.98 | .173 | 4.39 | .218 | 5.64 |
| 25P | 1.188 | 30.18 | .965 | 24.51 | .692 | 17.58 | .218 | 5.54 | .202 | 5.13 | .395 | 10.03 | .808 | 20.52 | .173 | 4.39 | .134 | 3.40 |
| 25S | 1.185 | 30.18 | .965 | 24.51 | .780 | 19.81 | .218 | 5.54 | .185 | 4.70 | .375 | 9.53 | .808 | 20.52 | .173 | 4.39 | .218 | 5.64 |
| 31P | 1.338 | 33.99 | 1.115 | 28.32 | .842 | 21.39 | .218 | 5.54 | .202 | 5.13 | .395 | 10.03 | .958 | 24.33 | .173 | 4.39 | .134 | 3.40 |
| 31S | 1.338 | 33.99 | 1.115 | 28.32 | .930 | 23.62 | .218 | 5.54 | .185 | 4.70 | .375 | 9.53 | .958 | 24.33 | .173 | 4.39 | .218 | 5.64 |
| 37P | 1.488 | 37.80 | 1.265 | 32.13 | .992 | 25.20 | .218 | 5.54 | .202 | 5.13 | .395 | 10.03 | 1.108 | 28.14 | .173 | 4.39 | .134 | 3.40 |
| 37S | 1.488 | 37.80 | 1.265 | 32.13 | 1.080 | 27.43 | .218 | 5.54 | .185 | 4.70 | .375 | 9.53 | 1.108 | 28.14 | .173 | 4.39 | .218 | 5.64 |
| 51P | 1.438 | 36.53 | 1.215 | 30.86 | .942 | 23.93 | .260 | 6.60 | .202 | 5.13 | .395 | 10.03 | 1.058 | 26.87 | .220 | 5.59 | .177 | 4.50 |
| 51S | 1.438 | 36.53 | 1.215 | 30.86 | 1.030 | 26.16 | .260 | 6.60 | .185 | 4.70 | .375 | 9.53 | 1.058 | 26.87 | .220 | 5.59 | .260 | 6.60 |

| Performance Specifications | |
|----------------------------|-------------------------------|
| Current Rating | 3 AMP |
| DWV | 600 VAC Sea level |
| Insulation Resistance | 5000 Megohms Minimum |
| Contact Resistance | 8 Milliohms Maximum |
| Operating Temperature | -55° C. to +150° C. |
| Shock, Vibration | 50 g., 20g. |
| Mating Force | (10 Ounces) X (# of Contacts) |

| Materials and Finishes | |
|------------------------|--|
| Insulator | Liquid Crystal Polymer (LCP)/ Polyphenylene Sulfide(PPS) |
| Pin Contact | Beryllium Copper, Gold over Nickel Plating |
| Socket Contact | Copper Alloy, Gold Over Nickel Plating |
| Hardware | 300 Series Stainless Steel |
| Encapsulant | Epoxy |

MWDL Low Profile Plastic Shell Micro-D Insulated Wire Termination



Micro-D Double and Triple Row



MWDL connectors are supplied with stranded mil spec hookup wire. Contacts are crimped to wire and potted with epoxy. Pin contacts are gold-plated high performance TwistPin type and are recessed into insulator to prevent damage. Socket contacts are gold plated, machined copper alloy. Glass-filled high temperature thermoplastic connector body. M22759/11 standard wire, or M22959/33 lightweight, high strength space grade wire. Meets performance requirements of MIL-DTL-83513, Class P. Available with 9 to 51 contacts. 3 A., 600 Vac, -55°C to +150°C.

How To Order Stranded Wire Connector

| Sample Part Number | MWDL | -37 | P | -6 | K | 5 | -18 | M |
|----------------------|---|-----|---|----|---|---|-----|---|
| Series | MWDL - Low Profile Plastic Shell Micro-D | | | | | | | |
| Contact Layout | 9, 15, 21, 25, 31, 37, 51 (See Table II) | | | | | | | |
| Contact Type | P - Pin Contacts S - Socket Contacts | | | | | | | |
| Wire Gage (AWG) | 4 - #24 6 - #26 8 - #28 0 - #30 (See Table II) | | | | | | | |
| Wire Type | K - Standard Wire Extruded PTFE per M22759/11, Silver-Plated Conductors (#30 AWG not available) J - Space Grade Wire High Strength, Lightweight, Crosslinked Modified ETFE per M22759/33, Silver-Plated Conductors | | | | | | | |
| Wire Color Code | 1 - White 5 - Color-Coded per MIL-STD-681. 7 - 10 Color Repeat Wires are solid color per MIL-STD-681 color code system. | | | | | | | |
| Wire Length (Inches) | 18 = 18 inches | | | | | | | |
| Mounting Hardware | B, M, M1, S, S1, P (See Table I) | | | | | | | |

E

Table I: Mounting Hardware

| B | P | M | M1 | S | S1 |
|-----------|----------------|--------------------------|------------------------------------|---------------------------|-------------------------------------|
| | | | | | |
| Thru-Hole | Jackpost #2-56 | Hex Head Jackscrew #2-56 | Hex Head Jackscrew, Extended #2-56 | Slot Head Jackscrew #2-56 | Slot Head Jackscrew, Extended #2-56 |



MWDL Low Profile Plastic Shell Micro-D Insulated Wire Termination

Table II: Dimensions



| Layout | A Max. | | B | | C Max. | | D Max. | | E Max. | | F Max. | | G Max. | | H Max. | | J Max. | |
|------------|--------|-------|---------------|---------------|--------|-------|--------|------|--------|------|--------|-------|--------|-------|--------|------|--------|------|
| | In. | mm. | In. ± .003 | mm. ± 0.08 | In. | mm. | In. | mm. | In. | mm. | In. | mm. | In. | mm. | In. | mm. | In. | mm. |
| 9P | .788 | 20.02 | .565 | 14.35 | .292 | 7.42 | .218 | 5.54 | .202 | 5.13 | .395 | 10.03 | .408 | 10.36 | .173 | 4.39 | .134 | 3.40 |
| 9S | .788 | 20.02 | .565 | 14.35 | .380 | 9.65 | .218 | 5.54 | .185 | 4.70 | .375 | 9.53 | .408 | 10.36 | .173 | 4.39 | .218 | 5.54 |
| 15P | .938 | 23.83 | .715 | 18.16 | .442 | 11.23 | .218 | 5.54 | .202 | 5.13 | .395 | 10.03 | .558 | 14.17 | .173 | 4.39 | .134 | 3.40 |
| 15S | .938 | 23.83 | .715 | 18.16 | .530 | 13.46 | .218 | 5.54 | .185 | 4.70 | .375 | 9.53 | .558 | 14.17 | .173 | 4.39 | .218 | 5.64 |
| 21P | 1.088 | 27.64 | .865 | 21.97 | .592 | 15.04 | .218 | 5.54 | .202 | 5.13 | .395 | 10.03 | .708 | 17.98 | .173 | 4.39 | .134 | 3.40 |
| 21S | 1.080 | 27.64 | .865 | 21.97 | .680 | 17.27 | .218 | 5.54 | .185 | 4.70 | .375 | 9.53 | .708 | 17.98 | .173 | 4.39 | .218 | 5.64 |
| 25P | 1.188 | 30.18 | .965 | 24.51 | .692 | 17.58 | .218 | 5.54 | .202 | 5.13 | .395 | 10.03 | .808 | 20.52 | .173 | 4.39 | .134 | 3.40 |
| 25S | 1.185 | 30.18 | .965 | 24.51 | .780 | 19.81 | .218 | 5.54 | .185 | 4.70 | .375 | 9.53 | .808 | 20.52 | .173 | 4.39 | .218 | 5.64 |
| 31P | 1.338 | 33.99 | 1.115 | 28.32 | .842 | 21.39 | .218 | 5.54 | .202 | 5.13 | .395 | 10.03 | .958 | 24.33 | .173 | 4.39 | .134 | 3.40 |
| 31S | 1.338 | 33.99 | 1.115 | 28.32 | .930 | 23.62 | .218 | 5.54 | .185 | 4.70 | .375 | 9.53 | .958 | 24.33 | .173 | 4.39 | .218 | 5.64 |
| 37P | 1.488 | 37.80 | 1.265 | 32.13 | .992 | 25.20 | .218 | 5.54 | .202 | 5.13 | .395 | 10.03 | 1.108 | 28.14 | .173 | 4.39 | .134 | 3.40 |
| 37S | 1.488 | 37.80 | 1.265 | 32.13 | 1.080 | 27.43 | .218 | 5.54 | .185 | 4.70 | .375 | 9.53 | 1.108 | 28.14 | .173 | 4.39 | .218 | 5.64 |
| 51P | 1.438 | 36.53 | 1.215 | 30.86 | .942 | 23.93 | .260 | 6.60 | .202 | 5.13 | .395 | 10.03 | 1.058 | 26.87 | .220 | 5.59 | .177 | 4.50 |
| 51S | 1.438 | 36.53 | 1.215 | 30.86 | 1.030 | 26.16 | .260 | 6.60 | .185 | 4.70 | .375 | 9.53 | 1.058 | 26.87 | .220 | 5.59 | .260 | 6.60 |

| Performance Specifications | |
|----------------------------|-------------------------------|
| Current Rating | 3 AMP |
| DWV | 600 VAC Sea level |
| Insulation Resistance | 5000 Megohms Minimum |
| Contact Resistance | 8 Milliohms Maximum |
| Operating Temperature | -55° C. to +150° C. |
| Shock, Vibration | 50 g., 20g. |
| Mating Force | (10 Ounces) X (# of Contacts) |

| Materials and Finishes | |
|------------------------|--|
| Insulator | Liquid Crystal Polymer (LCP)/ Polyphenylene Sulfide(PPS) |
| Pin Contact | Beryllium Copper, Gold Over Nickel Plating |
| Socket Contact | Copper Alloy, Gold Over Nickel Plating |
| Hardware | 300 Series Stainless Steel |
| Encapsulant | Epoxy |

MWDL Low Profile Plastic Shell Micro-D Solid Wire Termination



Micro-D Double
and Triple Row



MWDL connectors are supplied with solid copper wire. Contacts are crimped to wire and potted with epoxy. Pin contacts are gold-plated high performance TwistPin type and are recessed into insulator to prevent damage. Socket contacts are gold plated, machined copper alloy. Glass-filled high temperature thermoplastic connector body. Choose gold-plated wire or pre-tinned with Sn60/Pb40 tin-lead solder. Meets performance requirements of MIL-DTL-83513, Class P. Available with 9 to 51 contacts. 3 A., 600 Vac, -55°C to +150°C.

How To Order Solid Wire Connector

| Sample Part Number | MWDL | -31 | S | -4 | C | 4 | -.250 | B |
|----------------------|--|-----|---|----|---|---|-------|---|
| Series | MWDL - Low Profile Plastic Shell Micro-D | | | | | | | |
| Contact Layout | 9, 15, 21, 25, 31, 37, 51, | | | | | | | |
| Contact Type | P - Pin Contacts S - Socket Contacts | | | | | | | |
| Wire Gage (AWG) | 4 - #24 5 - #25 6 - #26 | | | | | | | |
| Wire Type | C - Solid Copper | | | | | | | |
| Wire Finish | 3 - Solder Dipped (Sn60/Pb40) 4 - Gold-plated | | | | | | | |
| Wire Length (Inches) | .125, .250, .500, 1.000, 1.500, 2.000 Wire Length In Inches | | | | | | | |
| Mounting Hardware | B, M, M1, S, S1, P, See Table I | | | | | | | |

E

Table I: Mounting Hardware

| B | P | M | M1 | S | S1 |
|-----------|----------------|--------------------------|------------------------------------|---------------------------|-------------------------------------|
| | | | | | |
| Thru-Hole | Jackpost #2-56 | Hex Head Jackscrew #2-56 | Hex Head Jackscrew, Extended #2-56 | Slot Head Jackscrew #2-56 | Slot Head Jackscrew, Extended #2-56 |



MWDL Low Profile Plastic Shell Micro-D Solid Wire Termination

Table II: Dimensions



| Layout | A Max. | | B | | C Max. | | D Max. | | E Max. | | F Max. | | G Max. | | H Max. | | J Max. | |
|--------|--------|-------|-----------|------------|--------|-------|--------|------|--------|------|--------|-------|--------|-------|--------|------|--------|------|
| | In. | mm. | In. ±.003 | mm. ± 0.08 | In. | mm. | In. | mm. | In. | mm. | In. | mm. | In. | mm. | In. | mm. | In. | mm. |
| 9P | .788 | 20.02 | .565 | 14.35 | .292 | 7.42 | .218 | 5.54 | .202 | 5.13 | .395 | 10.03 | .408 | 10.36 | .173 | 4.39 | .134 | 3.40 |
| 9S | .788 | 20.02 | .565 | 14.35 | .380 | 9.65 | .218 | 5.54 | .185 | 4.70 | .375 | 9.53 | .408 | 10.36 | .173 | 4.39 | .218 | 5.54 |
| 15P | .938 | 23.83 | .715 | 18.16 | .442 | 11.23 | .218 | 5.54 | .202 | 5.13 | .395 | 10.03 | .558 | 14.17 | .173 | 4.39 | .134 | 3.40 |
| 15S | .938 | 23.83 | .715 | 18.16 | .530 | 13.46 | .218 | 5.54 | .185 | 4.70 | .375 | 9.53 | .558 | 14.17 | .173 | 4.39 | .218 | 5.64 |
| 21P | 1.088 | 27.64 | .865 | 21.97 | .592 | 15.04 | .218 | 5.54 | .202 | 5.13 | .395 | 10.03 | .708 | 17.98 | .173 | 4.39 | .134 | 3.40 |
| 21S | 1.080 | 27.64 | .865 | 21.97 | .680 | 17.27 | .218 | 5.54 | .185 | 4.70 | .375 | 9.53 | .708 | 17.98 | .173 | 4.39 | .218 | 5.64 |
| 25P | 1.188 | 30.18 | .965 | 24.51 | .692 | 17.58 | .218 | 5.54 | .202 | 5.13 | .395 | 10.03 | .808 | 20.52 | .173 | 4.39 | .134 | 3.40 |
| 25S | 1.185 | 30.18 | .965 | 24.51 | .780 | 19.81 | .218 | 5.54 | .185 | 4.70 | .375 | 9.53 | .808 | 20.52 | .173 | 4.39 | .218 | 5.64 |
| 31P | 1.338 | 33.99 | 1.115 | 28.32 | .842 | 21.39 | .218 | 5.54 | .202 | 5.13 | .395 | 10.03 | .958 | 24.33 | .173 | 4.39 | .134 | 3.40 |
| 31S | 1.338 | 33.99 | 1.115 | 28.32 | .930 | 23.62 | .218 | 5.54 | .185 | 4.70 | .375 | 9.53 | .958 | 24.33 | .173 | 4.39 | .218 | 5.64 |
| 37P | 1.488 | 37.80 | 1.265 | 32.13 | .992 | 25.20 | .218 | 5.54 | .202 | 5.13 | .395 | 10.03 | 1.108 | 28.14 | .173 | 4.39 | .134 | 3.40 |
| 37S | 1.488 | 37.80 | 1.265 | 32.13 | 1.080 | 27.43 | .218 | 5.54 | .185 | 4.70 | .375 | 9.53 | 1.108 | 28.14 | .173 | 4.39 | .218 | 5.64 |
| 51P | 1.438 | 36.53 | 1.215 | 30.86 | .942 | 23.93 | .260 | 6.60 | .202 | 5.13 | .395 | 10.03 | 1.058 | 26.87 | .220 | 5.59 | .177 | 4.50 |
| 51S | 1.438 | 36.53 | 1.215 | 30.86 | 1.030 | 26.16 | .260 | 6.60 | .185 | 4.70 | .375 | 9.53 | 1.058 | 26.87 | .220 | 5.59 | .260 | 6.60 |

| Performance Specifications | |
|----------------------------|-------------------------------|
| Current Rating | 3 AMP |
| DWV | 600 VAC Sea level |
| Insulation Resistance | 5000 Megohms Minimum |
| Contact Resistance | 8 Milliohms Maximum |
| Operating Temperature | -55° C. to +150° C. |
| Shock, Vibration | 50 g., 20g. |
| Mating Force | (10 Ounces) X (# of Contacts) |

| Materials and Finishes | |
|------------------------|--|
| Insulator | Liquid Crystal Polymer (LCP)/ Polyphenylene Sulfide(PPS) |
| Pin Contact | Beryllium Copper, Gold over Nickel Plating |
| Socket Contact | Copper Alloy, Gold Over Nickel Plating |
| Hardware | 300 Series Stainless Steel |
| Encapsulant | Epoxy |

MWDL Low Profile Plastic Shell Micro-D Back-To-Back Cables



Micro-D Double and Triple Row

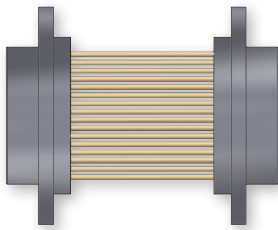

Factory terminated "back-to-back" jumper cables simplify ordering and reduce assembly labor. Contacts are crimped to wire and potted with epoxy. Pin contacts are gold-plated high performance TwistPin type and are recessed into insulator to prevent damage. Socket contacts are gold plated, machined copper alloy. Glass-filled high temperature thermoplastic connector body. M22759/11 standard wire, or M22959/33 lightweight, high strength space grade wire. Meets performance requirements of MIL-DTL-83513, Class P. Available with 9 to 51 contacts. 3 A., 600 Vac, -55°C to +150°C.

| How To Order | |
|-----------------------------|---|
| Sample Part Number | MWDL -37 GP -6 K 1 -18 P |
| Series | MWDL - Low Profile Plastic Shell Micro-D |
| Contact Layout | 9, 15, 21, 25, 31, 37, 51 (See Table II) |
| Connector Type | GP - Pin Connector Both Ends GS - Socket Contacts Both Ends CS - Pin Connector to Socket Connector |
| Wire Gage (AWG) | 4 - #24 6 - #26 8 - #28 0 - #30 (J Wire Only) |
| Wire Type | K Standard Wire Extruded PTFE per M22759/11, Silver-Plated Conductors (#30 AWG not available) J - Space Grade Wire High Strength, Lightweight, Crosslinked Modified ETFE per M22759/33 Silver-Plated Conductors |
| Wire Color Code | 1 - White 5 - Color-Coded per MIL-STD-681. Wires 1-10 are solid color, 11 and up are striped 7 - 10 Color Repeat, wires are solid color per MIL-STD-681 color code system. |
| Wire Length (Inches) | 18 - 18 inches (2" minimum for 2 rows, 3" minimum for 3 rows). |
| Mounting Hardware | B, M, M1, S, S1, P (See Table I) |

| Table I: Mounting Hardware | | | | | |
|----------------------------|----------------|--------------------------|------------------------------------|---------------------------|-------------------------------------|
| B | P | M | M1 | S | S1 |
| | | | | | |
| Thru-Hole | Jackpost #2-56 | Hex Head Jackscrew #2-56 | Hex Head Jackscrew, Extended #2-56 | Slot Head Jackscrew #2-56 | Slot Head Jackscrew, Extended #2-56 |



MWDL Low Profile Plastic Shell Micro-D Back-To-Back Cables

Table II: Dimensions



| Layout | A Max. | | B | | C Max. | | D Max. | | E Max. | | F Max. | | G Max. | | H Max. | | J Max. | |
|------------|--------|-------|---------------|---------------|--------|-------|--------|------|--------|------|--------|-------|--------|-------|--------|------|--------|------|
| | In. | mm. | In. ± .003 | mm. ± 0.08 | In. | mm. | In. | mm. | In. | mm. | In. | mm. | In. | mm. | In. | mm. | In. | mm. |
| 9P | .788 | 20.02 | .565 | 14.35 | .292 | 7.42 | .218 | 5.54 | .202 | 5.13 | .395 | 10.03 | .408 | 10.36 | .173 | 4.39 | .134 | 3.40 |
| 9S | .788 | 20.02 | .565 | 14.35 | .380 | 9.65 | .218 | 5.54 | .185 | 4.70 | .375 | 9.53 | .408 | 10.36 | .173 | 4.39 | .218 | 5.54 |
| 15P | .938 | 23.83 | .715 | 18.16 | .442 | 11.23 | .218 | 5.54 | .202 | 5.13 | .395 | 10.03 | .558 | 14.17 | .173 | 4.39 | .134 | 3.40 |
| 15S | .938 | 23.83 | .715 | 18.16 | .530 | 13.46 | .218 | 5.54 | .185 | 4.70 | .375 | 9.53 | .558 | 14.17 | .173 | 4.39 | .218 | 5.54 |
| 21P | 1.088 | 27.64 | .865 | 21.97 | .592 | 15.04 | .218 | 5.54 | .202 | 5.13 | .395 | 10.03 | .708 | 17.98 | .173 | 4.39 | .134 | 3.40 |
| 21S | 1.080 | 27.64 | .865 | 21.97 | .680 | 17.27 | .218 | 5.54 | .185 | 4.70 | .375 | 9.53 | .708 | 17.98 | .173 | 4.39 | .218 | 5.54 |
| 25P | 1.188 | 30.18 | .965 | 24.51 | .692 | 17.58 | .218 | 5.54 | .202 | 5.13 | .395 | 10.03 | .808 | 20.52 | .173 | 4.39 | .134 | 3.40 |
| 25S | 1.185 | 30.18 | .965 | 24.51 | .780 | 19.81 | .218 | 5.54 | .185 | 4.70 | .375 | 9.53 | .808 | 20.52 | .173 | 4.39 | .218 | 5.54 |
| 31P | 1.338 | 33.99 | 1.115 | 28.32 | .842 | 21.39 | .218 | 5.54 | .202 | 5.13 | .395 | 10.03 | .958 | 24.33 | .173 | 4.39 | .134 | 3.40 |
| 31S | 1.338 | 33.99 | 1.115 | 28.32 | .930 | 23.62 | .218 | 5.54 | .185 | 4.70 | .375 | 9.53 | .958 | 24.33 | .173 | 4.39 | .218 | 5.54 |
| 37P | 1.488 | 37.80 | 1.265 | 32.13 | .992 | 25.20 | .218 | 5.54 | .202 | 5.13 | .395 | 10.03 | 1.108 | 28.14 | .173 | 4.39 | .134 | 3.40 |
| 37S | 1.488 | 37.80 | 1.265 | 32.13 | 1.080 | 27.43 | .218 | 5.54 | .185 | 4.70 | .375 | 9.53 | 1.108 | 28.14 | .173 | 4.39 | .218 | 5.54 |
| 51P | 1.438 | 36.53 | 1.215 | 30.86 | .942 | 23.93 | .260 | 6.60 | .202 | 5.13 | .395 | 10.03 | 1.058 | 26.87 | .220 | 5.59 | .177 | 4.50 |
| 51S | 1.438 | 36.53 | 1.215 | 30.86 | 1.030 | 26.16 | .260 | 6.60 | .185 | 4.70 | .375 | 9.53 | 1.058 | 26.87 | .220 | 5.59 | .260 | 6.60 |

| Performance Specifications | |
|----------------------------|-------------------------------|
| Current Rating | 3 AMP |
| DWV | 600 VAC Sea level |
| Insulation Resistance | 5000 Megohms Minimum |
| Contact Resistance | 8 Milliohms Maximum |
| Operating Temperature | -55° C. to +150° C. |
| Shock, Vibration | 50 g., 20g. |
| Mating Force | (10 Ounces) X (# of Contacts) |

| Materials and Finishes | |
|------------------------|--|
| Insulator | Liquid Crystal Polymer (LCP)/ Polyphenylene Sulfide(PPS) |
| Pin Contact | Beryllium Copper, Gold over Nickel Plating |
| Socket Contact | Copper Alloy, Gold Over Nickel Plating |
| Hardware | 300 Series Stainless Steel |
| Encapsulant | Epoxy |

MWDL Low Profile Plastic Shell Micro-D Right Angle PCB Termination



Micro-D Double
and Triple Row



Low profile MWDL connectors have reduced flange height compared to standard MWDM Micro-D connectors. These thru-hole "CBR" style Micro-D connectors have solder dipped leads, gold-plated leads optional on .100" centers. Connectors are backfilled with epoxy. Pin contacts are gold-plated high performance TwistPin type and are recessed into insulator to prevent damage. Socket contacts are gold plated, machined copper alloy. Stainless steel hardware. Optional #2-56 threaded inserts in board mounting holes. Glass-filled LCP thermoplastic insulators and tray withstand immersion in +260C solder for 10 seconds. Meets performance requirements of MIL-DTL-83513, Class P. Available with 9 to 51 contacts. 3 A., 600 Vac, -55°C to +150°C.

E

| How To Order Right Angle PCB Connector | |
|--|--|
| Sample Part Number | MWDL -21 S CBR P T .110 -513 |
| Series | MWDL - Low Profile Plastic Shell Micro-D |
| Contact Layout | 9, 15, 21, 25, 31, 37, 51 |
| Contact Type | P - Pin Contacts S - Socket Contacts |
| Termination Type | CBR - Condensed Board Right Angle |
| Hardware Option | (Omit for None) P - Jackpost Jackposts for Rear Panel Mounting R1 - .032" Panel R2 - .047" Panel R3 - .062" Panel R4 - .093" Panel R5 - .125" Panel R6 - .125" Panel (See Table I) |
| Threaded Insert Option | Omit - For Thru-Holes T - Threaded Inserts in Board Mounting Holes. #2-56 Female Thread. M - Threaded Inserts in Board Mounting Holes. M2 Metric Thread. |
| PC Tail Length | .110, .125, .150, .190, .250 |
| Gold-Plated Terminal Mod Code | Omit - These connectors are solder-dipped in 60/40 tin lead solder. To delete the solder dip and change to gold-plated terminal add code 513 |

| Table I: Jackpost Options | | |
|---|---|---|
| No Designator | P | R1 Thru R5 |
| <p>THREADED INSERT</p> | | <p>Panel</p> |
| <p>Thru-Hole For use with Glenair jackposts only. Order hardware separately. Install with threadlocking compound.</p> | <p>Standard Jackpost Factory installed, not intended for removal.</p> | <p>Jackpost for Rear Panel Mounting Shipped loosely installed. Install with permanent threadlocking compound.</p> |



MWDL Low Profile Plastic Shell Micro-D Right Angle PCB Termination

Table I: Dimensions



| Layout | A Max. | | B | | C Max. | | D Max. | | E | | F Max. | | G Max. | | H | | J | |
|--------|--------|-------|-----------|-----------|--------|-------|--------|------|------|------|--------|-------|--------|------|-----------|-----------|------|------|
| | In. | mm. | In. ±.003 | mm. ±0.08 | In. | mm. | In. | mm. | In. | mm. | In. | mm. | In. | mm. | In. ±.010 | mm. ±0.25 | In. | mm. |
| 9P | .788 | 20.02 | .565 | 14.35 | .292 | 7.42 | .218 | 5.54 | .250 | 6.35 | .425 | 10.80 | .202 | 5.13 | .230 | 5.84 | .134 | 3.40 |
| 9S | .788 | 20.02 | .565 | 14.35 | .380 | 9.65 | .218 | 5.54 | .250 | 6.35 | .425 | 10.80 | .185 | 4.70 | .230 | 5.84 | .218 | 5.54 |
| 15P | .938 | 23.83 | .715 | 18.16 | .442 | 11.23 | .218 | 5.54 | .250 | 6.35 | .425 | 10.80 | .202 | 5.13 | .130 | 3.30 | .134 | 3.40 |
| 15S | .938 | 23.83 | .715 | 18.16 | .530 | 13.46 | .218 | 5.54 | .250 | 6.35 | .425 | 10.80 | .185 | 4.70 | .130 | 3.30 | .218 | 5.54 |
| 21P | 1.088 | 27.64 | .865 | 21.97 | .592 | 15.04 | .218 | 5.54 | .250 | 6.35 | .425 | 10.80 | .202 | 5.13 | .130 | 3.30 | .134 | 3.40 |
| 21S | 1.080 | 27.64 | .865 | 21.97 | .680 | 17.27 | .218 | 5.54 | .250 | 6.35 | .425 | 10.80 | .185 | 4.70 | .130 | 3.30 | .218 | 5.54 |
| 25P | 1.188 | 30.18 | .965 | 24.51 | .692 | 17.58 | .218 | 5.54 | .250 | 6.35 | .425 | 10.80 | .202 | 5.13 | .130 | 3.30 | .134 | 3.40 |
| 25S | 1.185 | 30.18 | .965 | 24.51 | .780 | 19.81 | .218 | 5.54 | .250 | 6.35 | .425 | 10.80 | .185 | 4.70 | .130 | 3.30 | .218 | 5.54 |
| 31P | 1.338 | 33.99 | 1.115 | 28.32 | .842 | 21.39 | .218 | 5.54 | .250 | 6.35 | .525 | 13.34 | .202 | 5.13 | .130 | 3.30 | .134 | 3.40 |
| 31S | 1.338 | 33.99 | 1.115 | 28.32 | .930 | 23.62 | .218 | 5.54 | .250 | 6.35 | .525 | 13.34 | .185 | 4.70 | .130 | 3.30 | .218 | 5.54 |
| 37P | 1.488 | 37.80 | 1.265 | 32.13 | .992 | 25.20 | .218 | 5.54 | .250 | 6.35 | .525 | 13.34 | .202 | 5.13 | .130 | 3.30 | .134 | 3.40 |
| 37S | 1.488 | 37.80 | 1.265 | 32.13 | 1.080 | 27.43 | .218 | 5.54 | .250 | 6.35 | .525 | 13.34 | .185 | 4.70 | .130 | 3.30 | .218 | 5.54 |
| 51P | 1.438 | 36.53 | 1.215 | 30.86 | .942 | 23.93 | .260 | 6.60 | .300 | 7.62 | .660 | 16.76 | .202 | 5.13 | .150 | 3.81 | .177 | 4.50 |
| 51S | 1.438 | 36.53 | 1.215 | 30.86 | 1.030 | 26.16 | .260 | 6.60 | .300 | 7.62 | .660 | 16.76 | .185 | 4.70 | .150 | 3.81 | .260 | 6.60 |

| Performance Specifications | |
|----------------------------|-------------------------------|
| Current Rating | 3 AMP |
| DWV | 600 VAC Sea level |
| Insulation Resistance | 5000 Megohms Minimum |
| Contact Resistance | 8 Milliohms Maximum |
| Operating Temperature | -55° C. to +150° C. |
| Shock, Vibration | 50 g., 20g. |
| Mating Force | (10 Ounces) X (# of Contacts) |

| Materials and Finishes | |
|------------------------|--|
| Connector Body | Liquid Crystal Polymer (LCP), Glass-filled |
| Pin Contact | Beryllium Copper, Gold over Nickel Plating |
| Socket Contact | Copper Alloy, Gold Over Nickel Plating |
| Hardware | 300 Series Stainless Steel |
| Encapsulant | Epoxy |

MWDL Low Profile Plastic Shell Micro-D Right Angle PCB Termination



Micro-D Double
and Triple Row

MWDL CBR PCB Layouts — Pin Connectors



9 PIN



31 PIN



15 PIN



37 PIN



21 PIN



51 PIN



25 PIN

Notes

1. Patterns shown are for connector mounting side of PC board.
2. Board mounting holes are .094" (2.39) diameter.
3. PC tails are .022" (0.56) maximum diameter.

E



MWDL Low Profile Plastic Shell Micro-D Right Angle PCB Termination

MWDL CBR PCB Layouts — Socket Connectors



9 Socket



31 Socket



15 Socket



37 Socket



21 Socket



51 Socket



25 Socket

Notes

1. Patterns shown are for connector mounting side of PCB board.
2. Board mounting holes are .094" (2.39) diameter.
3. PC tails are .022" (0.56) maximum diameter.

Section F Combo Micro-D for High Power Applications



Product Selection Guide

New and now available:

Right angle GMPM combo power and signal PCB Micro-D connectors.

Consult factory for ordering information.



Glenair's Combo Micro-D's combine the size and weight advantages of a Micro -D connector with the added ability to handle higher power needs. These connectors feature combinations of .079 inch (2mm) power contacts and TwistPin signal contacts.

13 Amp Current Rating – Available in three styles: solder cup, pre-wired pigtailed or printed circuit board, these Micro-D connectors handle up to #16 AWG wire.

Introducing The GMPM Right Angle Combo Micro-D – our newest addition adds right angle mount PCB board mount capability to our combo high power and signal offerings. Consult the factory for ordering information.

GMPM Combo
Solder Cup
Page F-4



Combo Micro-D Solder Cup Connectors

Nonremovable solder cup #16 power contacts for termination to #16 AWG or smaller wire. Micro pins accept #26 AWG or smaller wire. Gold plated contacts are backfilled with rigid epoxy.

GMPM Combo
Pre-Wired
Page F-7



Combo Micro-D Pre-Wired Pigtailed

Crimp contacts are terminated to insulated Teflon® wire. Connectors are backpotted with epoxy, providing strain relief and environmental protection.

GMPM Combo
Vertical Mount
PCB
Page F-10



Combo Micro-D Printed Circuit Board

Ideal for flexible or rigid circuits, these vertical mount connectors feature high temperature materials to withstand soldering heat. A full range of hardware options is available.

GMPM Combo
90° mount
PCB
Page F-13



Combo Micro-D Printed Circuit Board

Ideal for flexible or rigid circuits, these 90° mount plug and receptacle connectors feature high temperature materials to withstand soldering heat. A full range of hardware options is available.

PLUG

RECEPTACLE



B112
 2 POWER CONTACTS

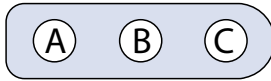

D112
 3 POWER CONTACTS

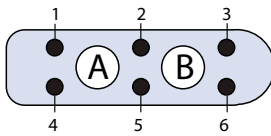

D113
 2 POWER CONTACTS
 6 MICRO CONTACTS

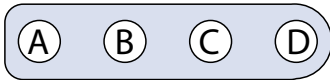
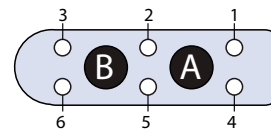

E112
 4 POWER CONTACTS

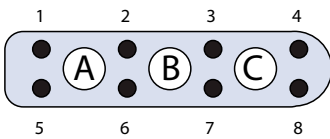
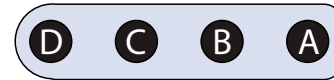

E113
 3 POWER CONTACTS
 8 MICRO CONTACTS

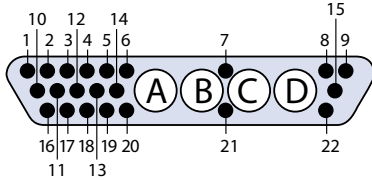
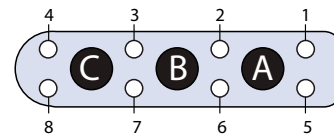

G101
 4 POWER CONTACTS
 22 MICRO CONTACTS

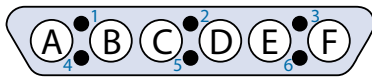
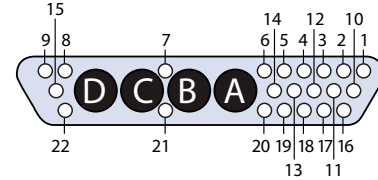

G103
 6 POWER CONTACTS
 6 MICRO CONTACTS



G111
 4 POWER CONTACTS
 20 MICRO CONTACTS



J112
 6 POWER CONTACTS



GMPM Combo Micro-D for High Power Applications Panel Mount Cutouts



Recommended Panel Cutout for Shell Sizes B, D, E, and J



| Dimensions | | | | |
|------------|---------------|---------------|-------------------------|-----------------------|
| Shell Size | B | | R | |
| | In. ± .003 | mm. ± 0.08 | In. + .004 - .000 | mm. +0.06 -0.00 |
| B | .715 | 18.16 | .550 | 13.95 |
| D | .965 | 24.51 | .800 | 20.30 |
| E | 1.115 | 28.32 | .949 | 24.11 |
| J | 1.615 | 41.02 | 1.449 | 36.81 |

Recommended Panel Cutout for Shell Size G





GMPM Combo Micro-D for High Power Applications Solder Cup



13 Amp Current Rating – Combo Micro-D's combine the size and weight advantages of a Micro -D connector with the added ability to handle higher power needs.

Solder Cup Contacts – Gold plated beryllium copper power contacts accommodate up to #16 AWG stranded wire. Signal contacts accept up to #26 AWG wire.

Mil Spec Performance – Glenair combo Micro-D connectors comply with the requirements of MIL-DTL-83513 and feature excellent resistance to high temperatures, shock and vibration.

F

| How To Order Combo Solder Cup Micro-D | |
|---------------------------------------|--|
| Sample Part Number | GMPM 2 -G111 P S B |
| Series | GMPM |
| Shell Finish | Aluminum Shell 1 - Cadmium 2 - Nickel 4 - Black Anodize 5 - Gold 6 - Chem Film Stainless Steel Shell 3 - Passivated |
| Shell Size and Insert Arrangement | B112, D112, D113, E112, E113, G101, G103, G111, J112 See Insert Arrangements on Page F-2 |
| Shell Style | P - Plug R - Receptacle |
| Termination Type | S - Solder Cup |
| Hardware | B, P, M, M1, S, S1, L, K, F, R, H |



G103P

Plug Connector
with TwistPin signal contacts and socket 2mm power contacts



G103R

Receptacle Connector
with socket TwistPin signal contacts and male 2mm power contacts

Table I: Mounting Hardware

| B | P | M | M1 | S | S1 | L | K | F | R | H |
|-----------|----------------|--------------------------|------------------------------------|---------------------------|-------------------------------------|--|--|--------------------------------------|-------------------------------------|-----------------------|
| | | | | | | | | | | |
| Thru-Hole | Jackpost #2-56 | Hex Head Jackscrew #2-56 | Hex Head Jackscrew, Extended #2-56 | Slot Head Jackscrew #2-56 | Slot Head Jackscrew, Extended #2-56 | Hex Head Jackscrew Non-Removable #2-56 | Slot Head Jackscrew Non-Removable Extended | Float Mount For Front Panel Mounting | Float Mount For Rear Panel Mounting | Threaded Insert #2-56 |

GMPM Combo Micro-D for High Power Applications Solder Cup



Table II: Dimensions for Shell Size G Connectors



F

| Layout | C Max | | D Max | | E ±0.10 | |
|--------------|-------|-------|-------|------|---------|------|
| | In. | mm. | In. | mm. | In. | mm. |
| G101P | 0.983 | 24.97 | 0.228 | 5.79 | 0.183 | 4.65 |
| G101R | 1.051 | 26.70 | 0.296 | 7.52 | 0.195 | 4.95 |
| G103P | 0.983 | 24.97 | 0.228 | 5.79 | 0.183 | 4.65 |
| G103R | 1.051 | 26.70 | 0.296 | 7.52 | 0.195 | 4.95 |
| G111P | 0.983 | 24.97 | 0.228 | 5.79 | 0.183 | 4.65 |
| G111R | 1.051 | 26.70 | .296 | 7.52 | 0.195 | 4.95 |

| Performance Specifications | |
|---------------------------------|--|
| Current Rating | 3 AMP Signal Contacts 13 AMP .079" (2mm) Power Contacts |
| Dielectric Withstanding Voltage | 600 VAC Sea Level 150 VAC 70,000 Feet |
| Insulation Resistance | 5000 Megohms Minimum |
| Contact Resistance | 8 Milliohms Maximum Signal Contacts |
| Low Level Contact Resistance | 32 Milliohms Maximum Signal Contacts |
| Magnetic Permeability | 2 μ Maximum |
| Operating Temperature | -55° C. to +150° C. |
| Shock | 50 g. |
| Vibration | 20 g. |
| Mating Force | (10 Ounces) X (# of Contacts) |
| Power Contacts | (28 oz) x (# of contacts) |

| Materials and Finishes | |
|--------------------------|---|
| Connector Shell | Aluminum Alloy 6061. See Ordering Info for Plating Options. |
| Insulator | Liquid Crystal Polymer (LCP) |
| Interfacial Seal | Fluorosilicone Rubber, Blue |
| Pin Contact, TwistPin | Copper Alloy with 50 Microinches Gold over Nickel Plating |
| Socket Contact | Copper Alloy with 50 Microinches Gold Over Nickel Plating |
| Pin Contact, 2mm. Power | Brass With 50 Microinches Gold Over Nickel Plating |
| Skt. Contact, 2mm. Power | Beryllium Copper With 50 Microinches Gold Over Nickel Plating |
| Hardware | 300 Series Stainless Steel |
| PCB Terminals | Gold-Plated Copper Alloy, Solder Dipped |
| Encapsulant | Epoxy |

Table III: Dimensions for Shell Size B, D, E and J Connectors



F

| Layout | A Max. | | B | | C Max. | | D Max. | | G Max. | | J Max. | |
|--------------|--------|-------|---------------|---------------|--------|-------|--------|------|--------|-------|--------|------|
| | In. | mm. | In. ± .003 | mm. ± 0.08 | In. | mm. | In. | mm. | In. | mm. | In. | mm. |
| B112P | .935 | 23.75 | .715 | 18.16 | .481 | 12.21 | .242 | 6.15 | .416 | 10.57 | .184 | 4.68 |
| B112R | .935 | 23.75 | .715 | 18.16 | .547 | 13.92 | .315 | 8.00 | .429 | 10.90 | .197 | 5.01 |
| D112P | 1.185 | 30.10 | .965 | 24.51 | .731 | 18.56 | .242 | 6.15 | .416 | 10.57 | .184 | 4.68 |
| D112R | 1.185 | 30.10 | .965 | 24.51 | .798 | 20.27 | .315 | 8.00 | .429 | 10.90 | .197 | 5.01 |
| D113P | 1.185 | 30.10 | .965 | 24.51 | .731 | 18.56 | .242 | 6.15 | .416 | 10.57 | .184 | 4.68 |
| D113R | 1.185 | 30.10 | .965 | 24.51 | .798 | 20.27 | .315 | 8.00 | .429 | 10.90 | .197 | 5.01 |
| E112P | 1.335 | 33.91 | 1.115 | 28.32 | .881 | 22.37 | .242 | 6.15 | .416 | 10.57 | .184 | 4.68 |
| E112R | 1.335 | 39.91 | 1.115 | 28.32 | .948 | 24.08 | .315 | 8.00 | .429 | 10.90 | .197 | 5.01 |
| E113P | 1.335 | 33.91 | 1.115 | 28.32 | .881 | 22.37 | .242 | 6.15 | .416 | 10.57 | .184 | 4.68 |
| E113R | 1.335 | 33.91 | 1.115 | 28.32 | .948 | 24.08 | .315 | 8.00 | .429 | 10.90 | .197 | 5.01 |
| J112P | 1.835 | 46.61 | 1.615 | 41.02 | 1.381 | 35.07 | .242 | 6.15 | .416 | 10.57 | .184 | 4.68 |
| J112R | 1.835 | 46.61 | 1.615 | 41.02 | 1.448 | 36.78 | .315 | 8.00 | .429 | 10.90 | .197 | 5.01 |

GMPM Combo Micro-D for High Power Applications Pre-Wired



13 Amp Current Rating – Combo Micro-D's combine the size and weight advantages of a Micro -D connector with the added ability to handle higher power needs.

Pre-Wired And Potted with Epoxy – Gold plated power contacts accommodate up to #16 AWG stranded wire. Signal contacts accept up to #24 AWG wire.

Mil Spec Performance – Glenair combo Micro-D connectors comply with the requirements of MIL-DTL-83513 and feature excellent resistance to high temperatures, shock and vibration.

How To Order Pre-wired Micro-D Power Connectors

| Sample Part Number | GMPM | 2- | B112 | P | T | 4 | -18 | K | 7- | 460 | B |
|---|---|----|---|---|--|---|-----|--|--|-----|---|
| Series | GMPM | | | | | | | | | | |
| Shell Finish | Stainless Steel Shell 1 - Cadmium 4 - Black Anodize 6 - Chem Film | | 2 - Nickel 5 - Gold | | Stainless Steel Shell 3 - Passivated | | | | | | |
| Shell Size and Insert Layout | B112, D112, D113, E112, E113, J112 | | | | | | | | | | |
| Shell Style | P = Plug R = Receptacle | | | | | | | | | | |
| Cable Entry Style | T - Top Entry | | | | | | | | | | |
| Wire Gage for #24 Contacts (AWG) | 4 - #24 6 - #26 8 - #28 0 - #30 Omit for D112 and B112 layouts containing power contacts only. | | | | | | | | | | |
| Wire Gage for #16 Contacts (AWG) | 16, 18, 20 | | | | | | | | | | |
| Wire Type | K - M22759/11 600 Vrms Teflon® (TFE) | | J - M22759/33 600 Vrms Modified Cross-Linked Tefzel® (ETFE) | | E - NEMA HP3-EB 600 Vrms Type E M16878/4 (TFE) | | | F - NEMA HP3-ETB Type ET M16878/6 250 Vrms | | | |
| Wire Color | 1 - White 2 - Yellow 5 - Color-Coded per MIL-STD-681 | | | | 7 - 10 Color Repeat Wires are solid color per MIL-STD-681 color code system. Note: #16 and #18 wire is always white. Wire colors apply to signal wire only. | | | | Note: power contacts supplied white only | | |
| Wire Length (mm) | 460 - Wire length in millimeters, rounded up to the nearest 10 mm. | | | | | | | | | | |
| Hardware | B, P, M, M1, S, S1, L, K, F, R, H | | | | | | | | | | |

F

Table I: Mounting Hardware

| B | P | M | M1 | S | S1 | L | K | F | R | H |
|-----------|----------|--------------------|------------------------------|---------------------|-------------------------------|----------------------------------|--|--------------------------------------|-------------------------------------|-----------------|
| | | | | | | | | | | |
| Thru-Hole | Jackpost | Hex Head Jackscrew | Hex Head Jackscrew, Extended | Slot Head Jackscrew | Slot Head Jackscrew, Extended | Hex Head Jackscrew Non-Removable | Slot Head Jackscrew Non-Removable Extended | Float Mount For Front Panel Mounting | Float Mount For Rear Panel Mounting | Threaded Insert |

Table II: Dimensions for Shell Size G Connectors



| Layout | C Max | | D Max | |
|--------------|-------|-------|-------|------|
| | In. | mm. | In. | mm. |
| G101P | 0.983 | 24.97 | 0.228 | 5.79 |
| G101R | 1.051 | 26.70 | 0.296 | 7.52 |
| G103P | 0.983 | 24.97 | 0.228 | 5.79 |
| G103R | 1.051 | 26.70 | 0.296 | 7.52 |
| G111P | 0.983 | 24.97 | 0.228 | 5.79 |
| G111R | 1.051 | 26.70 | .296 | 7.52 |

| Performance Specifications | |
|---------------------------------|--|
| Current Rating | 3 AMP Signal Contacts 13 AMP .079" (2mm) Power Contacts |
| Dielectric Withstanding Voltage | 600 VAC Sea Level 150 VAC 70,000 Feet |
| Insulation Resistance | 5000 Megohms Minimum |
| Contact Resistance | 8 Milliohms Maximum Signal Contacts |
| Low Level Contact Resistance | 32 Milliohms Maximum Signal Contacts |
| Magnetic Permeability | 2 μ Maximum |
| Operating Temperature | -55° C. to +150° C. |
| Shock | 50 g. |
| Vibration | 20 g. |
| Mating Force | (10 ounces) x (number of contacts) |
| Power Contacts | (28 ounces) x (number of contacts) |

| Materials and Finishes | |
|--------------------------|---|
| Connector Shell | Aluminum Alloy 6061. See Ordering Info for Plating Options. |
| Insulator | Liquid Crystal Polymer (LCP) |
| Interfacial Seal | Fluorosilicone Rubber, Blue |
| Pin Contact, TwistPin | Copper Alloy with 50 Microinches Gold over Nickel Plating |
| Socket Contact, | Copper Alloy with 50 Microinches Gold Over Nickel Plating |
| Pin Contact, 2mm. Power | Brass With 50 Microinches Gold Over Nickel Plating |
| Skt. Contact. 2mm. Power | Beryllium Copper With 50 Microinches Gold Over Nickel Plating |
| Hardware | 300 Series Stainless Steel |
| PCB Terminals | Gold-Plated Copper Alloy, Solder Dipped |
| Encapsulant | Epoxy Resin |

GMPM Combo Micro-D for High Power Applications Pre-Wired



Table III: Dimensions for Shell Size B, D, E and J



F

| Layout | A Max. | | B | | C Max. | | D Max. | | G Max. | | H Max. | | J Max. | |
|--------------|--------|-------|--------------|--------------|--------|-------|--------|------|--------|-------|--------|-------|--------|------|
| | In. | mm. | In. ±.003 | mm. ±0.08 | In. | mm. | In. | mm. | In. | mm. | In. | mm. | In. | mm. |
| B112P | .935 | 23.75 | .715 | 18.16 | .481 | 12.21 | .242 | 6.15 | .416 | 10.57 | .550 | 13.97 | .184 | 4.68 |
| B112R | .935 | 23.75 | .715 | 18.16 | .547 | 13.92 | .315 | 8.00 | .429 | 10.90 | .550 | 13.97 | .197 | 5.01 |
| D112P | 1.185 | 30.01 | .965 | 24.51 | .731 | 18.56 | .242 | 6.15 | .416 | 10.57 | .800 | 20.32 | .184 | 4.68 |
| D112R | 1.185 | 30.01 | .965 | 24.51 | .798 | 20.27 | .315 | 8.00 | .429 | 10.90 | .800 | 20.32 | .197 | 5.01 |
| D113P | 1.185 | 30.01 | .965 | 24.51 | .731 | 18.56 | .242 | 6.15 | .416 | 10.57 | .800 | 20.32 | .184 | 4.68 |
| D113R | 1.185 | 30.01 | .965 | 24.51 | .798 | 20.27 | .315 | 8.00 | .429 | 10.90 | .800 | 20.32 | .197 | 5.01 |
| E112P | 1.335 | 33.91 | 1.115 | 28.32 | .881 | 22.37 | .242 | 6.15 | .416 | 10.57 | .950 | 24.13 | .184 | 4.68 |
| E112R | 1.335 | 39.91 | 1.115 | 28.32 | .948 | 24.08 | .315 | 8.00 | .429 | 10.90 | .950 | 24.13 | .197 | 5.01 |
| E113P | 1.335 | 33.91 | 1.115 | 28.32 | .881 | 22.37 | .242 | 6.15 | .416 | 10.57 | .950 | 24.13 | .184 | 4.68 |
| E113R | 1.335 | 33.91 | 1.115 | 28.32 | .948 | 24.08 | .315 | 8.00 | .429 | 10.90 | .950 | 24.13 | .197 | 5.01 |
| J112P | 1.835 | 46.61 | 1.615 | 41.02 | 1.381 | 35.07 | .242 | 6.15 | .416 | 10.57 | 1.450 | 36.83 | .184 | 4.68 |
| J112R | 1.835 | 46.61 | 1.615 | 41.02 | 1.448 | 36.78 | .315 | 8.00 | .429 | 10.90 | 1.450 | 36.83 | .197 | 5.01 |



GMPM Combo Micro-D for High Power Applications Vertical Mount Printed Circuit Board



13 Amp Current Rating – Combo Micro-D's combine the size and weight advantages of a Micro-D connector with the added ability to handle higher power needs.

Printed Circuit Board Terminals – Ideal for flexible circuits or rigid boards, these gold plated PC tail contacts are sealed with epoxy encapsulant and are non-removable.

How To Order Vertical Mount PCB Combo Micro-D Connectors

| Sample Part Number | GMPM | 2 | B112 | R | CBS | PN | -.109 |
|--|---|---|--|---|-----|----|-------|
| Series | GMPM | | | | | | |
| Shell Finish | Aluminum Shell 1 - Cadmium 2 - Nickel 4 - Black Anodize 5 - Gold 6 - Chem Film | | Stainless Steel Shell 3 - Passivated | | | | |
| Shell Size and Insert Arrangement | B112, D112, D113, E113, G103 | | | | | | |
| Shell Style | P – Plug  | | R – Receptacle  | | | | |
| Termination Style | CBS - Compact Vertical Mount | | | | | | |
| Hardware | NN – No Jackpost, No Threaded Insert PN – Extended Jackpost for .062" (1.6) PCB, No Threaded Insert RN – Extended Jackpost for .196" (5.0) PCB, No Threaded Insert NU – 2-56 UNC Threaded Insert, No Jackposts NM – Metric M2 Threaded Insert, No Jackposts SU – Short Jackpost, 2-56 UNC Threaded Insert SM – Short Jackpost, M2 Metric Threaded Insert | | Rear Panel Jackposts Supplied either with U style 2-56 UNC or M style M2 Threaded Inserts TU or TM – 0.094" (2.4) Panel VU or VM – 0.062" (1.6) Panel WU or WM – 0.047" (1.2) Panel XU or XM – 0.031" (0.8) Panel XU or XM – 0.023" (0.6) Panel | | | | |
| PC Tail Length | .109, .150, .172, .190, .250 Length in Inches ± .015 (0.38) | | | | | | |

Table I: Jackpost Options

| NN | PN and RN | NU, NM | SU, SM | TU, VU, WU, XU, YU TM, VM, WM, XM, YM |
|---|---|---|--|---|
|  |  |  |  |  |
| Thru-Hole | Jackpost Kit PN – .062 (1.6) PCB RN – .196 (5.0) PCB | Threaded Inserts | Jackpost With Threaded Insert | Jackpost for Rear Panel Mounting |

GMPM Combo Micro-D for High Power Applications Vertical Mount Printed Circuit Board



Table II: Dimensions For Shell Size B, D, E and G



F

| Layout | A Max. | | B | | C Max. | | D Max. | | E Max. | | G Max. | | J Max. | |
|--------------|--------|-------|---------------|---------------|--------|-------|--------|------|--------|------|--------|------|--------|------|
| | In. | mm. | In. ± .003 | mm. ± 0.08 | In. | mm. | In. | mm. | In. | mm. | In. | mm. | In. | mm. |
| B112P | .935 | 23.75 | .715 | 18.16 | .481 | 12.21 | .242 | 6.15 | .315 | 8.00 | .355 | 9.02 | .184 | 4.68 |
| B112R | .935 | 23.75 | .715 | 18.16 | .547 | 13.92 | .315 | 8.00 | .315 | 8.00 | .355 | 9.02 | .197 | 5.01 |
| D112P | 1.185 | 30.01 | .965 | 24.51 | .731 | 18.56 | .242 | 6.15 | .315 | 8.00 | .355 | 9.02 | .184 | 4.68 |
| D112R | 1.185 | 30.01 | .965 | 24.51 | .798 | 20.27 | .315 | 8.00 | .315 | 8.00 | .355 | 9.02 | .197 | 5.01 |
| D113P | 1.185 | 30.01 | .965 | 24.51 | .731 | 18.56 | .242 | 6.15 | .315 | 8.00 | .355 | 9.02 | .184 | 4.68 |
| D113R | 1.185 | 30.01 | .965 | 24.51 | .798 | 20.27 | .315 | 8.00 | .315 | 8.00 | .355 | 9.02 | .197 | 5.01 |
| E113P | 1.335 | 33.91 | 1.115 | 28.32 | .881 | 22.37 | .242 | 6.15 | .315 | 8.00 | .355 | 9.02 | .184 | 4.68 |
| E113R | 1.335 | 33.91 | 1.115 | 28.32 | .949 | 24.11 | .315 | 8.00 | .315 | 8.00 | .355 | 9.02 | .197 | 5.01 |
| G103P | 1.435 | 36.45 | 1.215 | 30.86 | .983 | 24.97 | .228 | 5.79 | .351 | 8.92 | .355 | 9.02 | .184 | 4.68 |
| G103R | 1.435 | 36.45 | 1.215 | 30.86 | 1.051 | 26.70 | .296 | 7.52 | .351 | 8.92 | .355 | 9.02 | .195 | 4.95 |

Power and Combo Micro-D PCB Layouts

Patterns shown are for connector mounting side of PC board.

Plated thru-holes to accept .081 (2.06) maximum diameter power pins marked A - C, and .022(.56) maximum diameter signal pins marked 1 - 8.

Plug Connectors

Receptacle Connectors

B112



D112

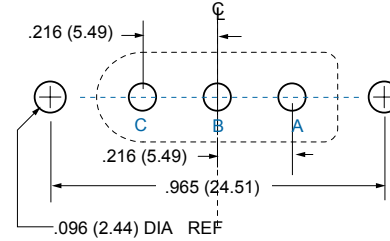
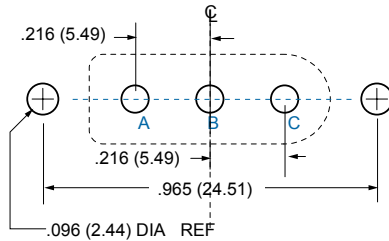

D113

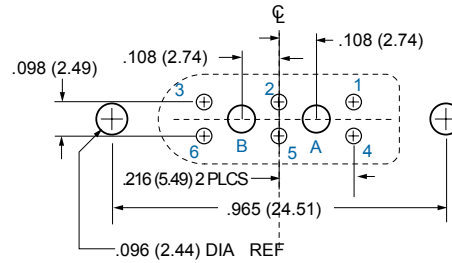
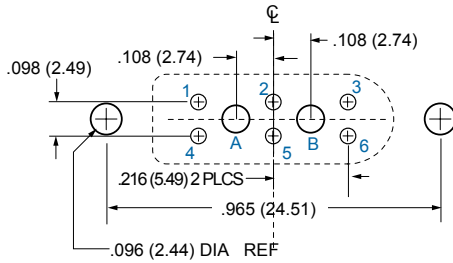

E113

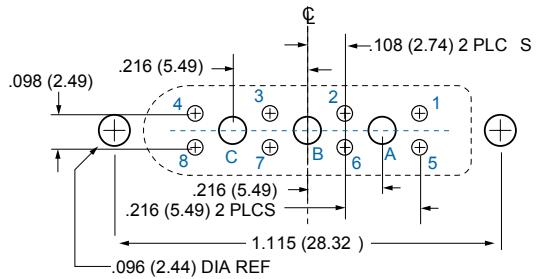

G103



F

GMPM Combo Micro-D for High Power Applications 90° Mount Printed Circuit Board



13 Amp Current Rating – Combo Micro-D's combine the size and weight advantages of a Micro-D connector with the added ability to handle higher power needs.

Printed Circuit Board Terminals – Ideal for flexible circuits or rigid boards, these gold plated PC tail contacts are sealed with epoxy encapsulant and are non-removable.

How To Order 90° Mount PCB Combo Micro-D Connectors

| Sample Part Number | GMPM | 2 | D112 | R | CBRT | TU | .109 |
|------------------------------------|---|---|---|---|------|----|------|
| Series | GMPM | | | | | | |
| Shell Finish | Aluminum Shell 1 - Cadmium 2 - Nickel 4 - Black Anodize 5 - Gold 6 - Chem Film | | Stainless Steel Shell 3 - Passivated | | | | |
| Shell Size and Insert Arrangement | B112, D112, D113, E112, E113, J112 | | | | | | |
| Shell Style | P – Plug R – Receptacle | | | | | | |
| Termination Style | CBRT – 90° with Encapsulating Tray Note all combo (power/signal connectors are supplied as CBRT Style) | | | | | | |
| Hardware | NU – 2-56 UNC Mounting Threads, No Jackposts NM – M2 Metric Mounting Threads, No Jackposts SU – Hex Jackpost, 2-56 UNC Mounting Threads SM – Hex Jackpost, M2 Mounting Threads | | Rear Panel Mount Supplied either with U style 2-56 UNC Mount or M style metric mount, M2 Threaded Inserts TU or TM – 0.094" (2.4) Panel VU or VM – 0.063" (1.6) Panel WU or WM – 0.047" (1.2) Panel XU or XM – 0.031" (0.8) Panel YU or YM – 0.025" (0.65) Panel ZU or ZM – 0.079" (2.0) Panel RU or RM – 0.059" (1.5) Panel | | | | |
| PCB Thickness Power Contacts (Pin) | .109(2.77), .150(3.81), .190(4.83), .250(6.35) Length in Inches(mm) ± .015 (0.38) | | | | | | |

F

Table I: Jackpost Options

| NU, NM | SU, SM | TU, VU, WU, XU, YU, ZU, RU TM, VM, WM, XM, YM, ZM, RM |
|------------------|-------------------------------|---|
| | | |
| Threaded Inserts | Jackpost With Threaded Insert | Jackpost for Rear Panel Mounting with PCB Mounting Thread |

Table II: Dimensions For Shell Size B, D, E and J



| Layout | A Max. | | B | | C Max. | |
|--------------------------|--------|-------|---------------|---------------|--------|-------|
| | In. | mm. | In. ± .003 | mm. ± 0.08 | In. | mm. |
| B112P | .935 | 23.75 | .715 | 18.16 | .481 | 12.21 |
| B112R | .935 | 23.75 | .715 | 18.16 | .550 | 13.92 |
| D112P & D113P | 1.185 | 30.10 | .965 | 24.51 | .731 | 18.56 |
| D112R & D113R | 1.185 | 30.10 | .965 | 24.51 | .800 | 20.27 |
| E112P & E113P | 1.335 | 33.91 | 1.115 | 28.32 | .881 | 22.37 |
| E112R & E113R | 1.335 | 33.91 | 1.115 | 28.32 | .950 | 24.08 |
| J112P | 1.835 | 46.61 | 1.615 | 41.02 | 1.381 | 35.07 |
| J112R | 1.835 | 46.61 | 1.615 | 41.02 | 1.450 | 36.81 |

Power Micro-D 90° PCB Layouts

Patterns shown are for connector mounting side of PC board.

Plated thru-holes to accept .081 (2.06) maximum diameter power pins marked A - F

Plug Connectors

Receptacle Connectors



F

Combo Micro-D 90° PCB Layouts

Patterns shown are for connector mounting side of PC board.

Plated thru-holes to accept .081(2.06) maximum diameter power pins marked A - F and .022 maximum diameter signal pins marked 1 - 10.

Plug Connectors



Receptacle Connectors



C AND PI FILTER
CONNECTORS

MICRO-D FILTERED CONNECTORS



For improved signal quality



Our Micro-D filter connectors serve double duty by also eliminating unwanted high-frequency noise. These connectors feature a precision milled aluminum shell and thermally conductive epoxy potting to prevent damage to filters during soldering. Configuration options include vertical and 90° printed circuit board orientations as well as time and cost saving solutions such as prewired pigtail filter connectors and in-line filter adapters. Glenair Micro-D connectors are in stock and available for immediate shipment.



Glenair®

Glenair, Inc.

1211 Air Way
Glendale, CA
91201-2497

818-247-6000
sales@glenair.com
www.glenair.com

Section G
Micro-D MIL-DTL-83513 Type Filter Connectors



Product Selection Guide

| | | |
|------------------------------|---|---|
| 240-030 Page G-7 |  | Solder Cup Filter Connector |
| 240-031 Page G-9 |  | Vertical PCB Micro-D Filter Connector |
| 240-032 Page G-14 |  | Insulated Wire Filter Connector |
| 240-033 Page G-16 |  | In-Line Filter Adapter |
| 240-034 Page G-18 |  | Right Angle PCB Micro-D Filter Connector |
| 240-075 Page G-22 |  | Rear Panel Mount Solder Cup Filter Connector |
| 240-076 Page G-24 |  | Rear Panel Mount Vertical PCB Filter Connector |
| 240-077 Page G-26 |  | Rear Panel Mount Insulated Wire Filter Connector |
| 240-078 Page G-28 |  | Rear Panel Mount Condensed Board Right Angle Filter Connector |
| 247-379 Page G-30 |  | Edge Board Micro-D Filter Connector |
| 2470-1048 Page G-34 |  | Combo Micro-D Filter connector |
| 249-EMITS-MICRO Page G-35 |  | EMI Troubleshooter Kit for Micro-D Connectors |

G



Micro-D Filter Connectors General Information

ABOUT MICRO-D FILTER CONNECTORS

Glenair Filter Micro-D connectors are low-pass filters, transmitting DC and low frequency signals while attenuating unwanted high frequency noise. These connectors are available with C filter elements or Pi filters. The filter substrates are constructed with a ceramic planar capacitor array.

Glenair Filter Micro-D's meet the demanding performance requirements of MIL-DTL-83513, except for a reduction in the dielectric withstanding voltage rating to 250 volts DC (higher voltages available on request). The TwistPin contact system assures superior performance in the most demanding applications.

C Filter

Single capacitor with low self inductance. This configuration is generally used to attenuate high frequency signals. The simple design allows high-frequency EMI to discharge to ground via the surrounding electromagnetic field. C filters occupy the least amount of space and offer lower cost compared to other filter types.

Pi Filter

Dual capacitors with a ferrite inductor positioned between them. The Pi filter provides excellent high-frequency performance due to its sharper rolloff.

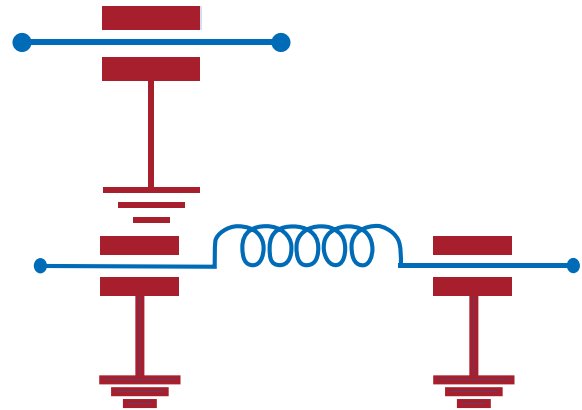

Micro-D C Filter Attenuation and Capacitance Values

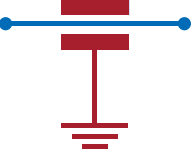
| C Filter | Filter Class | Capacitance pF | No Load Insertion Loss (dB Minimum) | | | |
|---|--------------|-------------------|-------------------------------------|--------|---------|--------------|
| | | | 1 MHz | 10 MHz | 100 MHz | 500-1000 MHz |
|  | A | 19,000 — 28,000 | 6 | 24 | 41 | 50 |
| | B | 16,000 — 22,500 | 5 | 23 | 39 | 49 |
| | C | 9,000 — 16,500 | 3 | 16 | 35 | 46 |
| | D | 4,000 — 6,000 | — | 8 | 28 | 41 |
| | E | 1,650 — 2,500 | — | 4 | 21 | 34 |
| | F | 400 — 650 | — | — | 10 | 23 |
| | G | 200 — 300 | — | — | 5 | 17 |
| | J | 35 — 60 | — | — | 1 | 8 |

Micro-D Pi Filter Attenuation and Capacitance Values

| Pi Filter | Filter Class | Capacitance pF | No Load Insertion Loss (dB Minimum) | | | |
|---|--------------|-------------------|-------------------------------------|--------|---------|--------------|
| | | | 1 MHz | 10 MHz | 100 MHz | 500-1000 MHz |
|  | A | 38,000 — 56,000 | 10 | 40 | 62 | 66 |
| | B | 32,000 — 45,000 | 8 | 35 | 60 | 62 |
| | C | 18,000 — 33,000 | 5 | 25 | 57 | 60 |
| | D | 8,000 — 12,000 | 1 | 14 | 50 | 58 |
| | E | 3,300 — 5,000 | — | 8 | 40 | 52 |
| | F | 800 — 1,300 | — | 2 | 15 | 32 |
| | G | 400 — 600 | — | 0.8 | 13 | 22 |
| | J | 70 — 120 | — | — | 4 | 15 |

Micro-D Filter Connector Contact Arrangements (Face View Pin Connector)



* Consult factory for filtered Micro-D connectors in other arrangements

| Performance Specifications | |
|---------------------------------|-------------------------------|
| Current Rating | 3 AMP |
| Dielectric Withstanding Voltage | 250 VDC |
| Working Voltage | 100 VDC |
| Insulation Resistance | 5000 Megohms Minimum |
| Contact Resistance | 8 milliohms Maximum |
| Low Level Contact Resistance | 32 milliohms Maximum |
| Magnetic Permeability | 2 μ Maximum |
| Operating Temperature | -55° C to +125° C |
| Shock | 50 g. |
| Vibration | 20 g. |
| Mating Force | (10 oz) x (# of Contacts) |
| Capacitance and Attenuation | (See Table on Preceding Page) |

| Materials and Finishes | |
|------------------------|--|
| Connector Shell | Aluminum Alloy 6061 or Stainless Steel, 300 Series, Passivated. See Ordering Info for Aluminum Plating Options. |
| Insulator | Liquid Crystal Polymer (LCP) |
| Seals | Fluorosilicone Rubber, Blue |
| Pin Contact | Beryllium Copper With 50 microinches Gold over Nickel Plating |
| Socket Contact | Copper Alloy With 50 microinches Gold Over Nickel Plating |
| Hardware | 300 Series Stainless Steel |
| PCB Terminals | Gold-Plated Copper Alloy, Solder Dipped |
| Capacitors | Planar Ceramic Array |
| Inductors | Ferrite |
| EMI Ground Spring | Beryllium Copper, Gold Plated |
| Encapsulant | Thermally Conductive Epoxy |



Micro-D Filter Connectors Recommended Panel Cutouts



Front Panel Mounting



Rear Panel Mounting

Metal Shell MWDM Connectors

| Layout | A | | B | | C | | D | | E | | F | |
|--------|---------------|---------------|---------------|---------------|---------------|---------------|---------------|---------------|---------------|---------------|---------------|---------------|
| | In. ± .003 | mm. ± 0.08 | In. ± .002 | mm. ± 0.05 | In. ± .002 | mm. ± 0.05 | In. ± .002 | mm. ± 0.05 | In. ± .005 | mm. ± 0.13 | In. ± .002 | mm. ± 0.05 |
| 9 | .565 | 14.35 | .410 | 10.41 | .091 | 2.31 | .290 | 7.37 | .256 | 6.50 | .126 | 3.20 |
| 15 | .715 | 18.16 | .560 | 14.22 | .091 | 2.31 | .290 | 7.37 | .256 | 6.50 | .126 | 3.20 |
| 21 | .865 | 21.97 | .710 | 18.03 | .091 | 2.31 | .290 | 7.37 | .256 | 6.50 | .126 | 3.20 |
| 25 | .965 | 24.51 | .810 | 20.57 | .091 | 2.31 | .290 | 7.37 | .256 | 6.50 | .126 | 3.20 |
| 31 | 1.115 | 28.32 | .960 | 24.38 | .091 | 2.31 | .290 | 7.37 | .256 | 6.50 | .126 | 3.20 |
| 37 | 1.265 | 32.13 | 1.110 | 28.19 | .091 | 2.31 | .290 | 7.37 | .256 | 6.50 | .126 | 3.20 |

Note: For front panel mounting, filtered connectors require a larger cut-out than standard MIL-DTL-83513 connectors.

MIL-STD-681 Color Code Chart



MIL-STD-681 Color Code Chart For Micro-D Connectors

| PIN NO. | MIL-STD-681 NUMBER | Base Color | First Stripe | Second Stripe | PIN NO. | MIL-STD-681 NO. | Base Color | First Stripe | Second Stripe | Third Stripe |
|---------|--------------------|------------|--------------|---------------|---------|-----------------|------------|--------------|---------------|--------------|
| 1 | 0 | BLK | | | 51 | 957 | WHT | GRN | VIO | |
| 2 | 1 | BRN | | | 52 | 958 | WHT | GRN | GRY | |
| 3 | 2 | RED | | | 53 | 967 | WHT | BLU | VIO | |
| 4 | 3 | ORN | | | 54 | 968 | WHT | BLU | GRY | |
| 5 | 4 | YEL | | | 55 | 978 | WHT | VIO | GRY | |
| 6 | 5 | GRN | | | 56 | 9012 | WHT | BLK | BRN | RED |
| 7 | 6 | BLU | | | 57 | 9013 | WHT | BLK | BRN | ORN |
| 8 | 7 | VIO | | | 58 | 9014 | WHT | BLK | BRN | YEL |
| 9 | 8 | GRY | | | 59 | 9015 | WHT | BLK | BRN | GRN |
| 10 | 9 | WHT | | | 60 | 9016 | WHT | BLK | BRN | BLU |
| 11 | 90 | WHT | BLK | | 61 | 9017 | WHT | BLK | BRN | VIO |
| 12 | 91 | WHT | BRN | | 62 | 9018 | WHT | BLK | BRN | GRY |
| 13 | 92 | WHT | RED | | 63 | 9023 | WHT | BLK | RED | ORN |
| 14 | 93 | WHT | ORN | | 64 | 9024 | WHT | BLK | RED | YEL |
| 15 | 94 | WHT | YEL | | 65 | 9025 | WHT | BLK | RED | GRN |
| 16 | 95 | WHT | GRN | | 66 | 9026 | WHT | BLK | RED | BLU |
| 17 | 96 | WHT | BLU | | 67 | 9027 | WHT | BLK | RED | VIO |
| 18 | 97 | WHT | VIO | | 68 | 9028 | WHT | BLK | RED | GRY |
| 19 | 98 | WHT | GRY | | 69 | 9034 | WHT | BLK | ORN | YEL |
| 20 | 901 | WHT | BLK | BRN | 70 | 9035 | WHT | BLK | ORN | GRN |
| 21 | 902 | WHT | BLK | RED | 71 | 9036 | WHT | BLK | ORN | BLU |
| 22 | 903 | WHT | BLK | ORN | 72 | 9037 | WHT | BLK | ORN | VIO |
| 23 | 904 | WHT | BLK | YEL | 73 | 9038 | WHT | BLK | ORN | GRY |
| 24 | 905 | WHT | BLK | GRN | 74 | 9045 | WHT | BLK | YEL | GRN |
| 25 | 906 | WHT | BLK | BLU | 75 | 9046 | WHT | BLK | YEL | BLU |
| 26 | 907 | WHT | BLK | VIO | 76 | 9047 | WHT | BLK | YEL | VIO |
| 27 | 908 | WHT | BLK | GRY | 77 | 9048 | WHT | BLK | YEL | GRY |
| 28 | 912 | WHT | BRN | RED | 78 | 9056 | WHT | BLK | GRN | BLU |
| 29 | 913 | WHT | BRN | ORN | 79 | 9057 | WHT | BLK | GRN | VIO |
| 30 | 914 | WHT | BRN | YEL | 80 | 9058 | WHT | BLK | GRN | GRY |
| 31 | 915 | WHT | BRN | GRN | 81 | 9067 | WHT | BLK | BLU | VIO |
| 32 | 916 | WHT | BRN | BLU | 82 | 9068 | WHT | BLK | BLU | GRY |
| 33 | 917 | WHT | BRN | VIO | 83 | 9078 | WHT | BLK | VIO | GRY |
| 34 | 918 | WHT | BRN | GRY | 84 | 9123 | WHT | BRN | RED | ORN |
| 35 | 923 | WHT | RED | ORN | 85 | 9124 | WHT | BRN | RED | YEL |
| 36 | 924 | WHT | RED | YEL | 86 | 9125 | WHT | BRN | RED | GRN |
| 37 | 925 | WHT | RED | GRN | 87 | 9126 | WHT | BRN | RED | BLU |
| 38 | 926 | WHT | RED | BLU | 88 | 9127 | WHT | BRN | RED | VIO |
| 39 | 927 | WHT | RED | VIO | 89 | 9128 | WHT | BRN | RED | GRY |
| 40 | 928 | WHT | RED | GRY | 90 | 9134 | WHT | BRN | ORN | YEL |
| 41 | 934 | WHT | ORN | YEL | 91 | 9135 | WHT | BRN | ORN | GRN |
| 42 | 935 | WHT | ORN | GRN | 92 | 9136 | WHT | BRN | ORN | BLU |
| 43 | 936 | WHT | ORN | BLU | 93 | 9137 | WHT | BRN | ORN | VIO |
| 44 | 937 | WHT | ORN | VIO | 94 | 9138 | WHT | BRN | ORN | GRY |
| 45 | 938 | WHT | ORN | GRY | 95 | 9145 | WHT | BRN | YEL | GRN |
| 46 | 945 | WHT | YEL | GRN | 96 | 9146 | WHT | BRN | YEL | BLU |
| 47 | 946 | WHT | YEL | BLU | 97 | 9147 | WHT | BRN | YEL | VIO |
| 48 | 947 | WHT | YEL | VIO | 98 | 9148 | WHT | BRN | YEL | GRY |
| 49 | 948 | WHT | YEL | GRY | 99 | 9156 | WHT | BRN | GRN | BLU |
| 50 | 956 | WHT | GRN | BLU | 100 | 9157 | WHT | BRN | GRN | VIO |



Micro-D Filter Connectors Special Products

FILTER CONNECTORS FOR SPACE FLIGHT

Connector Material and Finish Options for Space Applications

- **Cadmium and silver plating are prohibited in space.**
- **Specify electroless nickel or gold for connector finish**

Some types of metals are prohibited for space flight. "Cadmium, zinc, chemically coated cadmium or zinc, or silver shall not be used as a connector or contact finish" (NASA EEE-INST-002: Instructions for EEE Parts Selection, Screening, Qualification, and Derating). NASA recommends electroless nickel or gold plating on connector shells and gold plating for contacts.

Outgassing

- **Standard filter connectors require thermal vacuum bakeout to meet outgassing requirements**
- **NASA screened filter connectors meet outgassing requirements**

Some flight equipment requires low-outgassing components in order to prevent degradation to optics and other sensitive instruments. The space industry has adopted a standardized test procedure, ASTM E595, to evaluate outgassing properties. In order to be considered outgassing compatible, a material must exhibit a total mass loss (TML) of less than 1.0% and a collected volatile condensable material (CVCM) of less than 0.1%. Some of the materials used in filter connectors, like fluorosilicone interfacial seals, must go through special processing to meet TML and CVCM requirements. Per EEE-INST-002, filter connectors subjected to +125° C as part of voltage conditioning do not require additional processing to meet the outgassing requirements. If processing is required, Glenair offers a 24 hour thermal vacuum outgassing at 125° C for filter connectors.

NASA Screening

- **"Mission critical" connectors for space flight should undergo rigorous 100% final inspection.**
- **Modification codes are available to invoke special screening.**

NASA recommends that connectors for space flight be specially screened. EEE-INST-002 contains three levels of screening: Level 1 for highest reliability with the lowest level of risk, Level 2 for high reliability with low to moderate risk, and Level 3 for standard reliability.

NASA Screening Levels and Modification Codes

| NASA Screening Level | Screening | Screening & X-Ray Inspection |
|-------------------------------|-----------|------------------------------|
| Level 1: Highest Reliability | Mod 429B | Mod 429R |
| Level 2: High Reliability | Mod 429 | Mod 429S |
| Level 3: Standard Reliability | Mod 429L | Mod 429T |

X-Ray Inspection



Real-Time X-Ray Machine

To reduce risk even further for mission critical applications, x-ray inspection on a real-time x-ray system is available. Samples subject to x-ray inspection per Mod code 844 will be screened for foreign object debris (FOD) and if applicable, broken strands. A minimum of two views for each sample will be stored and are available upon request.

Add the MOD codes listed in the table below to the end of a part number to invoke special test or processing requirements.

| | |
|---------------------------|----------|
| Thermal Vacuum Outgassing | Mod 186M |
| X-Ray Inspection | Mod 844 |

240-030
Micro-D Filter Connectors
Solder Cup



Glenair Filtered Solder Cup Micro-D's provide EMI solutions in a miniaturized M83513 type connector. These connectors feature ceramic capacitor planar arrays and ferrite inductors. Solder cups accept #26 thru #30 AWG wire, or specify oversize contacts for #24 gage wire.

Choose Pi or C Filter Arrays in eight filter classes and six layouts. Glenair filtered Micro-D connectors comply with applicable MIL-DTL-83513 requirements and are 100% intermateable with standard connectors.

Choose 9 to 37 Contacts, with standard cadmium or nickel plating on the connector housing or choose optional finishes such as gold or chem film.

| How To Order Filter Micro-D Connectors with Solder Cups | | | | | | | |
|---|---|-----------|---|----------|----------|----------|----------|
| Sample Part Number | 240-030 | -2 | -25 | P | P | B | B |
| Series | 240-030 | | | | | | |
| Shell Finish | Aluminum Shell 1 - Cadmium 4 - Black Anodize 6 - Chem Film | | Stainless Steel Shell 3 - Passivated | | | | |
| Contact Layout | 9, 15, 21, 25, 31, 37 (See Table III) | | | | | | |
| Contact Type | Solder Cup Contacts for #24 AWG or Smaller Wire P - Pin S - Socket | | | | | | |
| Filter Type | C - C Filter P - Pi Filter (See Table II) | | | | | | |
| Filter Class | A, B, C, D, E, F, G, J (See Table II) | | | | | | |
| Hardware | B, P, M, M1, S, S1, L, K, H (See Table I) | | | | | | |

| Table I: Micro-D Mounting Hardware | | | | | | | | |
|-------------------------------------|--|-------------------------------------|--|--------------------------------------|---|----------------------------------|--|-----------------|
| B | P | M | M1 | S | S1 | L | K | H |
| | | | | | | | | |
| Thru-Hole Order Hardware Separately | Jackpost Removable Includes Nut and Washer | Jackscrew Hex Head Removable E-ring | Jackscrew Hex Head Removable E-ring Extended | Jackscrew Slot Head Removable E-ring | Jackscrew Slot Head Removable E-ring Extended | Jackscrew Hex Head Non-Removable | Jackscrew Slot Head Non-Removable Extended | Threaded Insert |



240-030 Micro-D Filter Connectors Solder Cup

Table II: Micro-D Filter Classes and Performance

| Filter Class | A | B | C | D | E | F | G | J |
|------------------|-------------|-------------|-------------|------------|-----------|----------|---------|--------|
| Capacitance (pF) | | | | | | | | |
| C Filter | 19000-28000 | 16000-22500 | 9000-16500 | 4000-6000 | 1650-2500 | 400-650 | 200-300 | 35-60 |
| Pi Filter | 38000-56000 | 32000-45000 | 18000-33000 | 8000-12000 | 3300-5000 | 800-1300 | 400-600 | 70-120 |

Table III: Dimensions



| Layout | A Max | | B | | C Max. | | D Max. | | E Max. | | F | | H Max. | |
|------------|-------|-------|---------------|---------------|--------|-------|--------|------|--------|------|---------------|---------------|--------|-------|
| | In. | mm. | In. ± .003 | mm. ± 0.08 | In. | mm. | In. | mm. | In. | mm. | In. ± .003 | mm. ± 0.08 | In. | mm. |
| 9P | .785 | 19.94 | .565 | 14.35 | .333 | 8.46 | .184 | 4.67 | .322 | 8.18 | .183 | 4.65 | .400 | 10.16 |
| 9S | .785 | 19.94 | .565 | 14.35 | .400 | 10.16 | .250 | 6.35 | .322 | 8.18 | .195 | 4.95 | .400 | 10.16 |
| 15P | .935 | 23.75 | .715 | 18.16 | .483 | 12.27 | .184 | 4.67 | .322 | 8.18 | .183 | 4.65 | .550 | 13.97 |
| 15S | .935 | 23.75 | .715 | 18.16 | .551 | 14.00 | .250 | 6.35 | .322 | 8.18 | .195 | 4.95 | .550 | 13.97 |
| 21P | 1.085 | 27.56 | .865 | 21.97 | .633 | 16.08 | .184 | 4.67 | .322 | 8.18 | .183 | 4.65 | .700 | 17.78 |
| 21S | 1.085 | 27.56 | .865 | 21.97 | .701 | 17.81 | .250 | 6.35 | .322 | 8.18 | .195 | 4.95 | .700 | 17.78 |
| 25P | 1.185 | 30.10 | .965 | 24.51 | .733 | 18.62 | .184 | 4.67 | .322 | 8.18 | .183 | 4.65 | .800 | 20.32 |
| 25S | 1.185 | 30.10 | .965 | 24.51 | .801 | 20.35 | .250 | 6.35 | .322 | 8.18 | .195 | 4.95 | .800 | 20.32 |
| 31P | 1.335 | 33.91 | 1.115 | 28.32 | .883 | 22.43 | .184 | 4.67 | .322 | 8.18 | .183 | 4.65 | .950 | 24.13 |
| 31S | 1.335 | 33.91 | 1.115 | 28.32 | .951 | 24.16 | .250 | 6.35 | .322 | 8.18 | .195 | 4.95 | .950 | 24.13 |
| 37P | 1.485 | 37.72 | 1.265 | 32.13 | 1.033 | 26.24 | .184 | 4.67 | .322 | 8.18 | .183 | 4.65 | 1.100 | 27.94 |
| 37S | 1.485 | 37.72 | 1.265 | 32.13 | 1.101 | 27.96 | .250 | 6.35 | .322 | 8.18 | .195 | 4.95 | 1.100 | 27.94 |

240-031
PCB Micro-D Filter Connectors
Vertical Mount



Vertical Mount Printed Circuit Board Micro-D Filter Connectors. These vertical mount PCB connectors are ideal for flexible circuit or motherboard applications.

Key Features include gold plated TwistPin contacts, machined aluminum shells, and either Pi or C filter elements. These environmentally sealed connectors are designed to meet the requirements of MIL-DTL-83513.

Integral Board Standoffs and Pre-Tinned Tails—These connectors are solder dipped (63/37 SnPb) and feature a full complement of mounting hardware options.

How To Order Micro-D Filter Vertical Mount PCB Connectors

| Sample Part Number | 240-031 | -2 | -25 | P | C | D | 1 | PN | |
|------------------------|--|----|--|---|--|---|---|----|--|
| Series | 240-031 | | | | | | | | |
| Shell Finish | Aluminum Shell 1 - Cadmium 4 - Black Anodize 6 - Chem Film | | Stainless Steel Shell 2 - Nickel 3 - Passivated 5 - Gold | | | | | | |
| Contact Layout | 9, 15, 21, 25, 31, 37 (See Table II) | | | | | | | | |
| Contact Type | P - Pin S - Socket | | | | | | | | |
| Filter Type | C - C Filter P - Pi Filter (See Table I) | | | | | | | | |
| Filter Class | A, B, C, D, E, F, G, J (See Table I) | | | | | | | | |
| PC Tail Length | 1 - .110 Inches (2.79) 2 - .250 Inches (6.35) Length in Inches ± .015 (0.38) | | | | | | | | |
| Hardware Option | PCB Hardware Options NN - No Jackpost, No Threaded Insert PN - Extended Jackpost for .062" (1.6) PCB, No Threaded Insert RN - Extended Jackpost for .196" (5.0) PCB, No Threaded Insert NU - Threaded Insert Only, No Jackposts PU - Short Jackpost and Threaded Insert | | Rear Panel Jackposts with Threaded Inserts R6U - 0.125" (3.2) Panel R5U - 0.094" (2.4) Panel R4U - 0.062" (1.6) Panel R3U - 0.047" (1.2) Panel R2U - 0.031" (0.8) Panel | | Jackscrew Options M - Hex Head Jackscrews S - Slot Head Jackscrews | | | | |

Table I: Micro-D Filter Classes and Performance

| Filter Class | A | B | C | D | E | F | G | J |
|------------------|-------------|-------------|-------------|------------|-----------|----------|---------|--------|
| Capacitance (pF) | | | | | | | | |
| C Filter | 19000-28000 | 16000-22500 | 9000-16500 | 4000-6000 | 1650-2500 | 400-650 | 200-300 | 35-60 |
| Pi Filter | 38000-56000 | 32000-45000 | 18000-33000 | 8000-12000 | 3300-5000 | 800-1300 | 400-600 | 70-120 |



240-031 PCB Micro-D Filter Connectors Vertical Mount

Table II: Dimensions



| Layout | A Max. | | B | | C Max. | | D Max. | | E Max. | | F | |
|------------|--------|-------|---------------|---------------|--------|-------|--------|------|--------|------|---------------|---------------|
| | In. | mm. | In. ± .003 | mm. ± 0.08 | In. | mm. | In. | mm. | In. | mm. | In. ± .004 | mm. ± 0.10 |
| 9P | .785 | 19.94 | .565 | 14.35 | .333 | 8.46 | .184 | 4.67 | .310 | 7.87 | .183 | 4.65 |
| 9S | .785 | 19.94 | .565 | 14.35 | .400 | 10.16 | .250 | 6.35 | .310 | 7.87 | .195 | 4.95 |
| 15P | .935 | 23.75 | .715 | 18.16 | .483 | 12.27 | .184 | 4.67 | .310 | 7.87 | .183 | 4.65 |
| 15S | .935 | 23.75 | .715 | 18.16 | .551 | 14.00 | .250 | 6.35 | .310 | 7.87 | .195 | 4.95 |
| 21P | 1.085 | 27.56 | .865 | 21.97 | .633 | 16.08 | .184 | 4.67 | .310 | 7.87 | .183 | 4.65 |
| 21S | 1.085 | 27.56 | .865 | 21.97 | .701 | 17.81 | .250 | 6.35 | .310 | 7.87 | .195 | 4.95 |
| 25P | 1.185 | 30.10 | .965 | 24.51 | .733 | 18.62 | .184 | 4.67 | .310 | 7.87 | .183 | 4.65 |
| 25S | 1.185 | 30.10 | .965 | 24.51 | .801 | 20.35 | .250 | 6.35 | .310 | 7.87 | .195 | 4.95 |
| 31P | 1.335 | 33.91 | 1.115 | 28.32 | .883 | 22.43 | .184 | 4.67 | .310 | 7.87 | .183 | 4.65 |
| 31S | 1.335 | 33.91 | 1.115 | 28.32 | .951 | 24.16 | .250 | 6.35 | .310 | 7.87 | .195 | 4.95 |
| 37P | 1.485 | 37.72 | 1.265 | 32.13 | 1.033 | 26.24 | .184 | 4.67 | .310 | 7.87 | .183 | 4.65 |
| 37S | 1.485 | 37.72 | 1.265 | 32.13 | 1.101 | 27.96 | .250 | 6.35 | .310 | 7.87 | .195 | 4.95 |

240-031
Vertical Mount PCB Micro-D Filter Connectors
Hardware Options



Micro-D Filter

Micro-D Filter Vertical PCB Hardware Options



NN Style
 Connector Supplied Without Hardware
 Thru-Hole, No Hardware



NU Style
 Connector Supplied With Threaded Inserts



PU Style
 Jackpost with Threaded Insert



RU Style
 Rear Panel Jackpost with Threaded Insert



Extended Jackpost
PN Style
 for .062" PCB

RN Style
 for .196" PCB



M Style
 Hex Head Jackscrew with E-Ring



S Style
 Slot Head Jackscrew with E-Ring

G



240-031 Vertical Mount PCB Micro-D Filter Connectors PCB Layouts

Micro-D Filter Vertical PCB Layouts — Pin Connector Shown

PC Tail Diameter $.018 \pm .002$ (0.46 ± 0.05)
Contact numbers shown are for pin connectors.



9 CONTACTS



15 CONTACTS



21 CONTACTS



25 CONTACTS



31 CONTACTS



37 CONTACTS

240-031
Vertical Mount PCB Micro-D Filter Connectors
PCB Layouts



Micro-D Filter

Micro-D Filter Vertical PCB Layouts — Socket Connector Shown

PC Tail Diameter $.018 \pm .002$ (0.46 ± 0.05)
 Contact numbers shown are for socket connectors.



9 CONTACTS



15 CONTACTS



21 CONTACTS



25 CONTACTS



31 CONTACTS



37 CONTACTS





240-032

Pre-Wired Micro-D Filter Connectors Insulated Wire



Glenair Filtered Pigtail Micro-D's provide EMI solutions in a miniaturized M83513 Micro-D connector. These connectors feature ceramic capacitor planar arrays and ferrite inductors. Insulated wire is factory precision-crimped to TwistPin contacts for superior reliability in the most demanding environments.

Choose Pi or C Filter Arrays in eight filter classes and six layouts. Glenair filtered Micro-D connectors comply with applicable MIL-DTL-83513 requirements and are 100% intermateable with standard connectors.

Choose 9 to 37 Contacts, with standard cadmium or nickel plating on the connector housing or choose optional finishes such as gold or chem film.

How To Order Filter Micro-D Connectors with Insulated Wire Pigtailed

| Sample Part Number | 240-032 | -2 | -25 | P | P | B | 6 | K | 1 | -18 | B |
|---------------------------|---|----|---|---|---|---|---|---|---|-----|---|
| Series | 240-032 | | | | | | | | | | |
| Shell Finish | Aluminum Shell 1 - Cadmium 2 - Nickel 4 - Black Anodize 5 - Gold 6 - Chem Film | | Stainless Steel Shell 3 - Passivated | | | | | | | | |
| Contact Layout | 9, 15, 21, 25, 31, 37 (See Table III) | | | | | | | | | | |
| Contact Type | Solder Cup Contacts for #24 AWG or Smaller Wire P - Pin S - Socket | | | | | | | | | | |
| Filter Type | C - C Filter P - Pi Filter (See Table II) | | | | | | | | | | |
| Filter Class | A, B, C, D, E, F, G, J (See Table I) | | | | | | | | | | |
| Wire Gage (AWG) | 4 - #24 6 - #26 | | | | | | | | | | |
| Wire Type | K - M22759/11 600 Vrms Teflon® (TFE) J - M22759/33 600 Vrms Modified Cross-Linked Tefzel® (ETFE) | | | | | | | | | | |
| Wire Color | 1 - White 2 - Yellow 5 - Color-Coded Stripes Per MIL-STD-681(#24 and #26 gage only) 7 - Ten Color Repeat | | | | | | | | | | |
| Wire Length Inches | 18 wire Length In Inches. "18" Specifies 18 Inches. | | | | | | | | | | |
| Hardware | B, P, M, M1, S, S1, L, K, H (See Table I) | | | | | | | | | | |

Table I: Micro-D Mounting Hardware

| B | P | M | M1 | S | S1 | L | K | H |
|--|---|--|--|---|---|--|---|--------------------|
| | | | | | | | | |
| Thru-Hole Order Hardware Separately | Jackpost Removable Includes Nut and Washer | Jackscrew Hex Head Removable E-ring | Jackscrew Hex Head Removable E-ring Extended | Jackscrew Slot Head Removable E-ring | Jackscrew Slot Head Removable E-ring Extended | Jackscrew Hex Head Non- Removable | Jackscrew Slot Head Non- Removable Extended | Threaded Insert |

240-032 Pre-Wired Micro-D Filter Connectors Insulated Wire



Table II: Micro-D Filter Classes and Performance

| Filter Class | A | B | C | D | E | F | G | J |
|------------------|-------------|-------------|-------------|------------|-----------|----------|---------|--------|
| Capacitance (pF) | | | | | | | | |
| C Filter | 19000-28000 | 16000-22500 | 9000-16500 | 4000-6000 | 1650-2500 | 400-650 | 200-300 | 35-60 |
| Pi Filter | 38000-56000 | 32000-45000 | 18000-33000 | 8000-12000 | 3300-5000 | 800-1300 | 400-600 | 70-120 |

Table III: Dimensions



| Layout | A Max | | B | | C Max. | | D Max. | | E Max. | | F | | H Max. | |
|------------|-------|-------|---------------|---------------|--------|-------|--------|------|--------|------|---------------|---------------|--------|-------|
| | In. | mm. | In. ± .003 | mm. ± 0.08 | In. | mm. | In. | mm. | In. | mm. | In. ± .004 | mm. ± 0.10 | In. | mm. |
| 9P | .785 | 19.94 | .565 | 14.35 | .333 | 8.46 | .184 | 4.67 | .322 | 8.18 | .183 | 4.65 | .400 | 10.16 |
| 9S | .785 | 19.94 | .565 | 14.35 | .400 | 10.16 | .250 | 6.35 | .322 | 8.18 | .195 | 4.95 | .400 | 10.16 |
| 15P | .935 | 23.75 | .715 | 18.16 | .483 | 12.27 | .184 | 4.67 | .322 | 8.18 | .183 | 4.65 | .550 | 13.97 |
| 15S | .935 | 23.75 | .715 | 18.16 | .551 | 14.00 | .250 | 6.35 | .322 | 8.18 | .195 | 4.95 | .550 | 13.97 |
| 21P | 1.085 | 27.56 | .865 | 21.97 | .633 | 16.08 | .184 | 4.67 | .322 | 8.18 | .183 | 4.65 | .700 | 17.78 |
| 21S | 1.085 | 27.56 | .865 | 21.97 | .701 | 17.81 | .250 | 6.35 | .322 | 8.18 | .195 | 4.95 | .700 | 17.78 |
| 25P | 1.185 | 30.10 | .965 | 24.51 | .733 | 18.62 | .184 | 4.67 | .322 | 8.18 | .183 | 4.65 | .800 | 20.32 |
| 25S | 1.185 | 30.10 | .965 | 24.51 | .801 | 20.35 | .250 | 6.35 | .322 | 8.18 | .195 | 4.95 | .800 | 20.32 |
| 31P | 1.335 | 33.91 | 1.115 | 28.32 | .883 | 22.43 | .184 | 4.67 | .322 | 8.18 | .183 | 4.65 | .950 | 24.13 |
| 31S | 1.335 | 33.91 | 1.115 | 28.32 | .951 | 24.16 | .250 | 6.35 | .322 | 8.18 | .195 | 4.95 | .950 | 24.13 |
| 37P | 1.485 | 37.72 | 1.265 | 32.13 | 1.033 | 26.24 | .184 | 4.67 | .322 | 8.18 | .183 | 4.65 | 1.100 | 27.94 |
| 37S | 1.485 | 37.72 | 1.265 | 32.13 | 1.101 | 27.96 | .250 | 6.35 | .322 | 8.18 | .195 | 4.95 | 1.100 | 27.94 |



240-033 Micro-D Pin-Socket In-Line Filter Adapters



Avoid Costly Redesign with Micro-D Filter Adapters. Upgrade your existing cables and boxes to meet EMI requirements. These pin-socket adapters can be plugged into any standard M83513 connectors. Simply unplug your existing cable, install the filter adapter, and plug the cable into the adapter.

In-Line Filter Adapters feature gold plated TwistPin contacts, machined aluminum shells, and either Pi or C filter elements. These environmentally sealed adapters are designed to meet the requirements of MIL-DTL-83513.

How To Order Micro-D In-Line Filter Adapters

| | | | | | | | |
|---------------------------|---|------------------------|---|-----------|----------|----------|----------|
| Sample Part Number | 240-033 | -2 | -21 | PS | C | D | P |
| Series | 240-033 | | | | | | |
| Shell Finish | Aluminum Shell 1 - Cadmium 4 - Black Anodize 6 - Chem Film | 2 - Nickel 5 - Gold | Stainless Steel Shell 3 - Passivated | | | | |
| Contact Layout | 9, 15, 21, 25, 31, 37 (See Table II) | | | | | | |
| Contact Type | PS - Pin/Socket | | | | | | |
| Filter Type | C - C Filter P - Pi Filter (See Table I) | | | | | | |
| Filter Class | A, B, C, D, E, F, G, J (See Table I) | | | | | | |
| Hardware | N - No Hardware P - Combination Jackscrew and Jackpost | | | | | | |

Micro-D In-Line Filter Adapter Contact Arrangements



Table I: Micro-D Filter Classes and Performance

| Filter Class | A | B | C | D | E | F | G | J |
|------------------|-------------|-------------|-------------|------------|-----------|----------|---------|--------|
| Capacitance (pF) | | | | | | | | |
| C Filter | 19000-28000 | 16000-22500 | 9000-16500 | 4000-6000 | 1650-2500 | 400-650 | 200-300 | 35-60 |
| Pi Filter | 38000-56000 | 32000-45000 | 18000-33000 | 8000-12000 | 3300-5000 | 800-1300 | 400-600 | 70-120 |

240-033 Micro-D Pin-Socket In-Line Filter Adapters



Table II: Dimensions



| Layout | A Max. | | B | | C Max. | | D Max. | | E Max. | | F | | G Max. | | H | | J Max. | | K Max. | |
|-------------|--------|-------|--------------|--------------|--------|-------|--------|------|--------|------|--------------|--------------|--------|-------|--------------|--------------|--------|-------|--------|------|
| | In. | mm. | In. ±.003 | mm. ±0.08 | In. | mm. | In. | mm. | In. | mm. | In. ±.004 | mm. ±0.10 | In. | mm. | In. ±.004 | mm. ±0.10 | In. | mm. | In. | mm. |
| 9PS | .785 | 19.94 | .565 | 14.35 | .400 | 10.16 | .250 | 6.35 | .310 | 7.87 | .195 | 4.95 | 1.400 | 35.56 | .183 | 4.65 | .333 | 8.46 | .184 | 4.67 |
| 15PS | .935 | 23.75 | .715 | 18.16 | .531 | 14.00 | .250 | 6.35 | .310 | 7.87 | .195 | 4.95 | 1.400 | 35.56 | .183 | 4.65 | .483 | 12.27 | .184 | 4.67 |
| 21PS | 1.085 | 27.56 | .865 | 21.97 | .701 | 17.81 | .250 | 6.35 | .310 | 7.87 | .195 | 4.95 | 1.400 | 35.56 | .183 | 4.65 | .633 | 16.08 | .184 | 4.67 |
| 25PS | 1.185 | 30.10 | .965 | 24.51 | .801 | 20.35 | .250 | 6.35 | .310 | 7.87 | .195 | 4.95 | 1.400 | 35.56 | .183 | 4.65 | .733 | 18.62 | .184 | 4.67 |
| 31PS | 1.335 | 33.91 | 1.115 | 28.32 | .951 | 24.16 | .250 | 6.35 | .310 | 7.87 | .195 | 4.95 | 1.400 | 35.56 | .183 | 4.65 | .883 | 22.43 | .184 | 4.67 |
| 37PS | 1.485 | 37.72 | 1.265 | 32.13 | 1.101 | 27.96 | .250 | 6.35 | .310 | 7.87 | .195 | 4.95 | 1.400 | 35.56 | .183 | 4.65 | 1.033 | 26.24 | .184 | 4.67 |



240-034 PCB Micro-D Filter Connectors Right Angle



Right Angle Board Mount Filtered Micro-D's. These connectors feature low-pass EMI filtering in a right angle header for PCB termination.

Key Features include gold plated TwistPin contacts, machined aluminum shells, and either Pi or C filter elements. These environmentally sealed connectors are designed to meet the requirements of MIL-DTL-83513.

.100" x .100" Board Spacing - These connectors are similar to "CBR" style Micro-D's and share the same board footprint, allowing retrofit to existing boards.

How To Order Micro-D Filtered Right Angle PCB Connectors

| Sample Part Number | 240-034 | -2 | -37 | S | P | E | PU | -.080 |
|-----------------------|---|----|---|---|--|---|----|-------|
| Series | 240-034 | | | | | | | |
| Shell Finish | Aluminum Shell 1 - Cadmium 4 - Black Anodize 6 - Chem Film | | Stainless Steel Shell 2 - Nickel 5 - Gold | | 3 - Passivated | | | |
| Contact Layout | 9, 15, 21, 25, 31, 37 (See Table II) | | | | | | | |
| Contact Type | P - Pin S - Socket | | | | | | | |
| Filter Type | C - C Filter P - Pi Filter (See Table I) | | | | | | | |
| Filter Class | A, B, C, D, E, F, G, J (See Table I) | | | | | | | |
| Hardware | PCB Hardware Options NN - No Jackpost, No Threaded Insert PN - Jackpost, No Threaded Insert NU - Threaded Insert Only, No Jackposts PU - Jackpost and Threaded Insert | | | | Rear Panel Jackposts with Threaded Inserts R6U - 0.125" (3.2) Panel R5U - 0.094" (2.4) Panel R4U - 0.062" (1.6) Panel R3U - 0.047" (1.2) Panel R2U - 0.031" (0.8) Panel | | | |
| PC Tail Length | .080 .110 .125 .150 .190 .250 Length in Inches ± .015(0.38) | | | | | | | |

Micro-D Jackpost options

| NN/NU | PN/PU | R2U Thru R6U |
|--|--|--|
| <p>HEX NUT EPOXY FILL</p> | | <p>Panel</p> |
| Thru-Hole: For use with Glenair jackposts only. Order hardware separately. Install w/ threadlocking compound. | Standard Jackpost: Factory installed, not intended for removal. | Jackpost for Rear Panel Mounting: Shipped loosely installed. Install w/ permanent threadlocking compound. |

Table I: Micro-D Filter Classes and Performance

| Filter Class | A | B | C | D | E | F | G | J |
|------------------|-------------|-------------|-------------|------------|-----------|----------|---------|--------|
| Capacitance (pF) | | | | | | | | |
| C Filter | 19000-28000 | 16000-22500 | 9000-16500 | 4000-6000 | 1650-2500 | 400-650 | 200-300 | 35-60 |
| Pi Filter | 38000-56000 | 32000-45000 | 18000-33000 | 8000-12000 | 3300-5000 | 800-1300 | 400-600 | 70-120 |

240-034
PCB Micro-D Filter Connectors
Right Angle



Table II: Dimensions



| Layout | A Max. | | B | | C Max. | | D Max. | | E Max. | | F | | K Max. | | C Filter | | | | Pi Filter | | | |
|------------|--------|-------|-------|--------|--------|-------|--------|------|--------|------|-------|--------|--------|-------|----------|-------|-------|-------|-----------|-------|-------|-------|
| | In. | mm. | In. | mm. | In. | mm. | In. | mm. | In. | mm. | In. | mm. | In. | mm. | In. | mm. | In. | mm. | In. | mm. | In. | mm. |
| | | | ±.003 | ± 0.08 | | | | | | | ±.004 | ± 0.10 | | | ±.010 | ±0.25 | ±.010 | ±0.25 | ±.010 | ±0.25 | ±.010 | ±0.25 |
| 9P | .785 | 19.94 | .565 | 14.35 | .333 | 8.46 | .184 | 4.67 | .310 | 7.87 | .183 | 4.65 | .335 | 8.51 | .440 | 11.18 | .460 | 11.68 | .740 | 18.80 | .760 | 19.30 |
| 9S | .785 | 19.94 | .565 | 14.35 | .400 | 10.16 | .250 | 6.35 | .310 | 7.87 | .195 | 4.95 | .335 | 8.51 | .440 | 11.18 | .460 | 11.68 | .740 | 18.80 | .760 | 19.30 |
| 15P | .935 | 23.75 | .715 | 18.16 | .483 | 12.27 | .184 | 4.67 | .310 | 7.87 | .183 | 4.65 | .335 | 8.51 | .340 | 8.64 | .460 | 11.68 | .640 | 16.26 | .760 | 19.30 |
| 15S | .935 | 23.75 | .715 | 18.16 | .551 | 14.00 | .250 | 6.35 | .310 | 7.87 | .195 | 4.95 | .335 | 8.51 | .340 | 8.64 | .460 | 11.68 | .640 | 16.26 | .760 | 19.30 |
| 21P | 1.085 | 27.56 | .865 | 21.97 | .633 | 16.08 | .184 | 4.67 | .310 | 7.87 | .183 | 4.65 | .335 | 8.51 | .340 | 8.64 | .460 | 11.68 | .640 | 16.26 | .760 | 19.30 |
| 21S | 1.085 | 27.56 | .865 | 21.97 | .701 | 17.81 | .250 | 6.35 | .310 | 7.87 | .195 | 4.95 | .335 | 8.51 | .340 | 8.64 | .460 | 11.68 | .640 | 16.26 | .760 | 19.30 |
| 25P | 1.185 | 30.10 | .965 | 24.51 | .733 | 18.62 | .184 | 4.67 | .310 | 7.87 | .183 | 4.65 | .335 | 8.51 | .340 | 8.64 | .460 | 11.68 | .640 | 16.26 | .760 | 19.30 |
| 25S | 1.185 | 30.10 | .965 | 24.51 | .801 | 20.35 | .250 | 6.35 | .310 | 7.87 | .195 | 4.95 | .335 | 8.51 | .340 | 8.64 | .460 | 11.68 | .640 | 16.26 | .760 | 19.30 |
| 31P | 1.335 | 33.91 | 1.115 | 28.32 | .883 | 22.43 | .184 | 4.67 | .310 | 7.87 | .183 | 4.65 | .430 | 10.92 | .340 | 8.64 | .460 | 11.68 | .640 | 16.26 | .760 | 19.30 |
| 31S | 1.335 | 33.91 | 1.115 | 28.32 | .951 | 24.16 | .250 | 6.35 | .310 | 7.87 | .195 | 4.95 | .430 | 10.92 | .340 | 8.64 | .460 | 11.68 | .640 | 16.26 | .760 | 19.30 |
| 37P | 1.485 | 37.72 | 1.265 | 32.13 | 1.033 | 26.24 | .184 | 4.67 | .310 | 7.87 | .183 | 4.65 | .430 | 10.92 | .340 | 8.64 | .460 | 11.68 | .640 | 16.26 | .760 | 19.30 |
| 37S | 1.485 | 37.72 | 1.265 | 32.13 | 1.101 | 27.96 | .250 | 6.35 | .310 | 7.87 | .195 | 4.95 | .430 | 10.92 | .340 | 8.64 | .460 | 11.68 | .640 | 16.26 | .760 | 19.30 |



240-034 PCB Micro-D Filter Connectors Right Angle

Micro-D Filter Right Angle PCB Layouts — Pin Connector

PC Tail Diameter $.018 \pm .002$ (0.46 ± 0.05)
 Contact numbers shown are for pin connectors.
 Patterns shown are for connector mounting side of PC board.



9 CONTACTS



15 CONTACTS



21 CONTACTS



25 CONTACTS



31 CONTACTS



37 CONTACTS

240-034 PCB Micro-D Filter Connectors Right Angle



Micro-D Filter

Micro-D Filter Right Angle PCB Layouts — Socket Connector

PC Tail Diameter $.018 \pm .002$ (0.46 ± 0.05)
 Contact numbers shown are for socket connectors.
 Patterns shown are for connector mounting side of PC board.



9 CONTACTS



15 CONTACTS



21 CONTACTS



25 CONTACTS



31 CONTACTS



37 CONTACTS





240-075 Rear Panel Mount Micro-D Filter Connectors Solder Cup



Glenair Rear Panel Mount Solder Cup Filter Micro-D's provide EMI solutions in a miniaturized M83513 type connector. These connectors feature ceramic capacitor planar arrays and ferrite inductors. Solder cups accept #26 thru #30 AWG wire, or specify oversize contacts for #24 gage wire.

Choose Pi or C Filter Arrays in eight filter classes and six layouts. Glenair filtered Micro-D connectors comply with applicable MIL-DTL-83513 requirements and are 100% intermateable with standard connectors.

Choose 9 to 37 Contacts, with standard cadmium or nickel plating on the connector housing or choose optional finishes such as gold or chem film.

How To Order Rear Panel Mount Micro-D Filter connectors with Solder Cups

| Sample Part Number | 240-075 | -2 | -25 | S | C | F | -R1 | -N | N |
|--------------------------------------|--|----|-----|---|---|---|-----|----|---|
| Series | 240-075 | | | | | | | | |
| Shell Finish | Aluminum Shell 1 - Cadmium 2 - Nickel 5 - Gold 6 - Chem Film 33 - Nickel/PTFE | | | | | | | | |
| Contact Layout | 9, 15, 21, 25, 31, 37 (See Table II) | | | | | | | | |
| Contact Type | P - Pin S - Socket | | | | | | | | |
| Filter Type | C - C Filter P - Pi Filter | | | | | | | | |
| Filter Class | A, B, C, D, E, F, G, J (See Table I) | | | | | | | | |
| Hardware Option See Note 1 | Rear Panel Mount Hardware Option R1 - 0.032" (.08) Panel R2 - 0.047" (.12) Panel R3 - 0.062" (.16) Panel R4 - 0.093" (.12) Panel R5 - 0.125" (.32) Panel R6 - 0.080" (.20) Panel | | | | | | | | |
| Plug EMI Ground Spring See Note 2 | G - Ground spring installed N - No ground spring (N applies to all receptacle assemblies) | | | | | | | | |
| O-Ring | C - Conductive N - Non-Conductive (Nitrile) | | | | | | | | |

Table I: Micro-D Filter Classes and Performance

| Filter Class | A | B | C | D | E | F | G | J |
|------------------|-------------|-------------|-------------|------------|-----------|----------|---------|--------|
| Capacitance (pF) | | | | | | | | |
| C Filter | 19000-28000 | 16000-22500 | 9000-16500 | 4000-6000 | 1650-2500 | 400-650 | 200-300 | 35-60 |
| Pi Filter | 38000-56000 | 32000-45000 | 18000-33000 | 8000-12000 | 3300-5000 | 800-1300 | 400-600 | 70-120 |

240-075
Rear Panel Mount Micro-D Filter Connectors
Solder Cup



Table II: Dimensions



| Shell Size | A ±.005 | | B ±.003 | | C Max | | D ±.005 | | E Max | | F±.003 | | G±.005 | | H Max | |
|------------|---------|-------|---------|-------|-------|-------|---------|-------|-------|------|--------|------|--------|-------|-------|------|
| | in. | mm | in. | mm | in. | mm | in. | mm | in. | mm | in. | mm | in. | mm | in. | mm |
| 9P | 0.960 | 0.960 | 0.565 | 14.35 | 0.334 | 8.48 | 0.480 | 12.19 | 0.184 | 4.67 | 0.183 | 4.65 | .790 | 20.07 | 0.310 | 7.87 |
| 9S | 0.960 | 0.960 | 0.565 | 14.35 | 0.400 | 10.16 | 0.480 | 12.19 | 0.250 | 6.35 | 0.195 | 4.95 | .790 | 20.07 | 0.310 | 7.87 |
| 15P | 1.110 | 1.110 | 0.715 | 18.16 | 0.484 | 12.29 | 0.480 | 12.19 | 0.184 | 4.67 | 0.183 | 4.65 | .940 | 23.88 | 0.310 | 7.87 |
| 15S | 1.110 | 1.110 | 0.715 | 18.16 | 0.550 | 13.97 | 0.480 | 12.19 | 0.250 | 6.35 | 0.195 | 4.95 | .940 | 23.88 | 0.310 | 7.87 |
| 21P | 1.260 | 1.260 | 0.865 | 21.97 | 0.634 | 16.10 | 0.480 | 12.19 | 0.184 | 4.67 | 0.183 | 4.65 | 1.090 | 27.69 | 0.310 | 7.87 |
| 21S | 1.260 | 1.260 | 0.865 | 21.97 | 0.700 | 17.78 | 0.480 | 12.19 | 0.250 | 6.35 | 0.195 | 4.95 | 1.090 | 27.69 | 0.310 | 7.87 |
| 25P | 1.360 | 1.360 | 0.965 | 24.51 | 0.734 | 18.64 | 0.480 | 12.19 | 0.184 | 4.67 | 0.183 | 4.65 | 1.190 | 30.23 | 0.310 | 7.87 |
| 25S | 1.360 | 1.360 | 0.965 | 24.51 | 0.800 | 20.32 | 0.480 | 12.19 | 0.250 | 6.35 | 0.195 | 4.95 | 1.190 | 30.23 | 0.310 | 7.87 |
| 31P | 1.510 | 1.510 | 1.115 | 28.32 | 0.884 | 22.45 | 0.480 | 12.19 | 0.184 | 4.67 | 0.183 | 4.65 | 1.340 | 34.04 | 0.310 | 7.87 |
| 31S | 1.510 | 1.510 | 1.115 | 28.32 | 0.950 | 24.13 | 0.480 | 12.19 | 0.250 | 6.35 | 0.195 | 4.95 | 1.340 | 34.04 | 0.310 | 7.87 |
| 37P | 1.660 | 1.660 | 1.265 | 32.13 | 1.034 | 26.26 | 0.480 | 12.19 | 0.184 | 4.67 | 0.183 | 4.65 | 1.490 | 37.85 | 0.310 | 7.87 |
| 37S | 1.660 | 1.660 | 1.265 | 32.13 | 1.100 | 27.94 | 0.480 | 12.19 | 0.250 | 6.35 | 0.195 | 4.95 | 1.490 | 37.85 | 0.310 | 7.87 |



Notes

- Mounting holes fitted with 2x .086-56 threaded insert, .15 min thread. (T3585-02CPF129).
- Ground spring not available on cadmium plated assemblies.
- Interface dimensions per MIL-DTL-83513.
- Electrical performance:
I.R.: 5000 Megohms min at 100 VDC
D.W.V.: 200 VDC
- Assembly to be identified with Glenair's name, part number, date code, and pin 1 identification.

Materials / Finishes

- Shell - Aluminum Alloy/See Chart
- Insulator - LCP/NA
- Contacts - Copper Alloy/Gold Plated
- Ground Spring - Stainless Steel/Gold Plated
- Socket Interfacial Seal: Fluorosilicone



240-076

Rear Panel Mount PCB Micro-D Filter Connectors Vertical Mount Style



Glenair Rear Panel Mount Micro-D, PCB Filter Connector

These vertical mount PCB connectors are ideal for flexible circuit or motherboard applications.

Key Features include gold plated TwistPin contacts, machined aluminum shells, and either Pi or C filter elements. These environmentally sealed connectors are designed to meet the requirements of MIL-DTL-83513.

Integral Board Standoffs and Pre-Tinned Tails These connectors are solder dipped (63/37 SnPb) and feature a full complement of mounting hardware options.

How To Order Rear Panel Mount Micro-D Filtered Vertical Mount PCB

| Sample Part Number | 240-076 | -2 | -25 | S | C | F | R1 | .110 | N | N |
|--------------------------------------|--|----|-----|---|---|---|----|------|---|---|
| Series | 240-076 | | | | | | | | | |
| Shell Finish | Aluminum Shell 1 - Cadmium 2 - Nickel 5 - Gold 6 - Chem Film 33 - Nickel/PTFE | | | | | | | | | |
| Contact Layout | 9, 15, 21, 25, 31, 37 (See Table II) | | | | | | | | | |
| Contact Type | P - Plug/Pin S - Receptacle/Socket | | | | | | | | | |
| Filter Type | C - C Filter P - Pi Filter | | | | | | | | | |
| Filter Class | A, B, C, D, E, F, G, J (See Table I) | | | | | | | | | |
| Hardware Option See Note 1 | Rear Panel Mount Hardware Option R1 - 0.032" (.08) Panel R2 - 0.047" (.12) Panel R3 - 0.062" (.16) Panel R4 - 0.093" (.12) Panel R5 - 0.125" (.32) Panel R6 - 0.080" (.20) Panel | | | | | | | | | |
| Lead Length | .080, .110, .125, .140, .150, .190, .250 | | | | | | | | | |
| Plug EMI Ground Spring See Note 2 | G - Ground Spring Installed N - No Ground Spring (N applies to all receptacle assemblies) | | | | | | | | | |
| O-Ring | C - Conductive N - Non-Conductive (Nitrile) | | | | | | | | | |

Table I: Micro-D Filter Classes and Performance

| Filter Class | A | B | C | D | E | F | G | J |
|------------------|-------------|-------------|-------------|------------|-----------|----------|---------|--------|
| Capacitance (pF) | | | | | | | | |
| C Filter | 19000-28000 | 16000-22500 | 9000-16500 | 4000-6000 | 1650-2500 | 400-650 | 200-300 | 35-60 |
| Pi Filter | 38000-56000 | 32000-45000 | 18000-33000 | 8000-12000 | 3300-5000 | 800-1300 | 400-600 | 70-120 |

240-076 PCB Rear Panel Mount Micro-D Filter Connectors Vertical Mount Style



Table II: Dimensions



| Shell Size | A ±.005 | | B ±.003 | | C Max | | D ±.005 | | E Max | | F ±.003 | | G ±.005 | | H Max | |
|------------|---------|-------|---------|-------|-------|--------|---------|-------|-------|------|---------|------|---------|-------|-------|------|
| | in. | mm | in. | mm | in. | mm | in. | mm | in. | mm | in. | mm | in. | mm | in. | mm |
| 9P | 0.960 | 24.38 | 0.565 | 14.35 | 0.334 | 364.52 | 0.480 | 12.19 | 0.184 | 4.67 | 0.183 | 4.65 | .790 | 20.07 | 0.310 | 7.87 |
| 9S | 0.960 | 24.38 | 0.565 | 14.35 | 0.400 | 364.52 | 0.480 | 12.19 | 0.250 | 6.35 | 0.195 | 4.95 | .790 | 20.07 | 0.310 | 7.87 |
| 15P | 1.110 | 28.19 | 0.715 | 18.16 | 0.484 | 461.29 | 0.480 | 12.19 | 0.184 | 4.67 | 0.183 | 4.65 | .940 | 23.88 | 0.310 | 7.87 |
| 15S | 1.110 | 28.19 | 0.715 | 18.16 | 0.550 | 461.29 | 0.480 | 12.19 | 0.250 | 6.35 | 0.195 | 4.95 | .940 | 23.88 | 0.310 | 7.87 |
| 21P | 1.260 | 32.00 | 0.865 | 21.97 | 0.634 | 558.06 | 0.480 | 12.19 | 0.184 | 4.67 | 0.183 | 4.65 | 1.090 | 27.69 | 0.310 | 7.87 |
| 21S | 1.260 | 32.00 | 0.865 | 21.97 | 0.700 | 558.06 | 0.480 | 12.19 | 0.250 | 6.35 | 0.195 | 4.95 | 1.090 | 27.69 | 0.310 | 7.87 |
| 25P | 1.360 | 34.54 | 0.965 | 24.51 | 0.734 | 622.58 | 0.480 | 12.19 | 0.184 | 4.67 | 0.183 | 4.65 | 1.190 | 30.23 | 0.310 | 7.87 |
| 25S | 1.360 | 34.54 | 0.965 | 24.51 | 0.800 | 622.58 | 0.480 | 12.19 | 0.250 | 6.35 | 0.195 | 4.95 | 1.190 | 30.23 | 0.310 | 7.87 |
| 31P | 1.510 | 38.35 | 1.115 | 28.32 | 0.884 | 719.35 | 0.480 | 12.19 | 0.184 | 4.67 | 0.183 | 4.65 | 1.340 | 34.04 | 0.310 | 7.87 |
| 31S | 1.510 | 38.35 | 1.115 | 28.32 | 0.950 | 719.35 | 0.480 | 12.19 | 0.250 | 6.35 | 0.195 | 4.95 | 1.340 | 34.04 | 0.310 | 7.87 |
| 37P | 1.660 | 42.16 | 1.265 | 32.13 | 1.034 | 816.13 | 0.480 | 12.19 | 0.184 | 4.67 | 0.183 | 4.65 | 1.490 | 37.85 | 0.310 | 7.87 |
| 37S | 1.660 | 42.16 | 1.265 | 32.13 | 1.100 | 816.13 | 0.480 | 12.19 | 0.250 | 6.35 | 0.195 | 4.95 | 1.490 | 37.85 | 0.310 | 7.87 |

Notes

- Mounting holes fitted with 2x .086-56 threaded insert, .15 min thread. (T3585-02CPF129).
- Ground spring not available on cadmium plated assemblies.
- Interface dimensions per MIL-DTL-83513.
- Electrical performance:
I.R.: 5000 Megohms min at 100 VDC
D.W.V.: 200 VDC
- Assembly to be identified with Glenair's name, part number, date code, and pin 1 identification.
- See 240-031 for PCB layout

Materials / Finishes

- Shell - Aluminum Alloy/See Chart
- Insulator - LCP/NA
- Contacts - Copper Alloy/Gold Plated
- Ground Spring - Stainless Steel/Gold Plated
- Socket Interfacial Seal: Fluorosilicone



240-077

Rear Panel Mount Micro-D Filter Connectors Insulated Wire



Glenair Filtered Insulated Wire Micro-D's provide EMI solutions in a miniaturized M83513 Micro-D connector. These connectors feature ceramic capacitor planar arrays and ferrite inductors. Insulated wire is factory precision-crimped to TwistPin contacts for superior reliability in the most demanding environments.

Choose Pi or C Filter Arrays in eight filter classes and six layouts. Glenair filtered Micro-D connectors comply with applicable MIL-DTL-83513 requirements and are 100% interchangeable with standard connectors.

Choose 9 to 37 Contacts, with standard cadmium or nickel plating on the connector housing or choose optional finishes such as gold or chem film.

How To Order Rear Panel Mount Filter Connectors with Insulated Wire

| Sample Part Number | 240-077 | -2 | -25 | S | C | F | -6 | K | 7 | -18 | R1 | N | N |
|------------------------|--|----|-----|---|---|---|----|---|---|-----|----|---|---|
| Series | 240-077 | | | | | | | | | | | | |
| Shell Finish | Aluminum Shell 1 - Cadmium 2 - Nickel 5 - Gold 6 - Chem Film 33 - Nickel/PTFE | | | | | | | | | | | | |
| Contact Layout | 9, 15, 21, 25, 31, 37 (See Table II) | | | | | | | | | | | | |
| Contact Type | P - Pin S - Socket | | | | | | | | | | | | |
| Filter Type | C - C Filter P - Pi Filter | | | | | | | | | | | | |
| Filter Class | A, B, C, D, E, F, G, J (See Table I) | | | | | | | | | | | | |
| Wire Gauge | 4 - 24 6 - 26 8 - 28 0 - 30 | | | | | | | | | | | | |
| Wire Type | K - M22759/11 J - M22759/33 E - NEMA HP3-EB (M16878/4) | | | | | | | | | | | | |
| Wire Color/Type | 1 - White 2 - Yellow 5 - Full Color 7 - 10 Color Repeat | | | | | | | | | | | | |
| Wire Length | 18 - 18 Inches | | | | | | | | | | | | |
| Hardware Option | Rear Panel Mount Hardware Option (See Note 1) B - No Hardware R1 - 0.032" (.08) Panel R2 - 0.047" (.12) Panel R3 - 0.062" (.16) Panel R4 - 0.093" (.12) Panel R5 - 0.125" (.32) Panel R6 - 0.080" (.20) Panel | | | | | | | | | | | | |
| Plug EMI Ground Spring | G - Ground spring installed N - No ground spring (N applies to all receptacle assemblies) (See Note 2) | | | | | | | | | | | | |
| O-Ring | C - Conductive N - Non-Conductive (Nitrile) | | | | | | | | | | | | |

Table I: Micro-D Filter Classes and Performance

| Filter Class | A | B | C | D | E | F | G | J |
|------------------|-------------|-------------|-------------|------------|-----------|----------|---------|--------|
| Capacitance (pF) | | | | | | | | |
| C Filter | 19000-28000 | 16000-22500 | 9000-16500 | 4000-6000 | 1650-2500 | 400-650 | 200-300 | 35-60 |
| Pi Filter | 38000-56000 | 32000-45000 | 18000-33000 | 8000-12000 | 3300-5000 | 800-1300 | 400-600 | 70-120 |

240-077
Rear Panel Mount Micro-D Filter Connectors
Insulated Wire



Table II: Dimensions



| Shell Size | A $\pm .005$ | | B $\pm .003$ | | C Max | | D $\pm .005$ | | E Max | | F $\pm .003$ | | G $\pm .005$ | | H Max | |
|------------|--------------|-------|--------------|-------|-------|-------|--------------|-------|-------|------|--------------|------|--------------|-------|-------|------|
| | in. | mm | in. | mm | in. | mm | in. | mm | in. | mm | in. | mm | in. | mm | in. | mm |
| 9P | 0.960 | 24.38 | 0.565 | 14.35 | 0.334 | 8.48 | 0.480 | 12.19 | 0.184 | 4.67 | 0.183 | 4.65 | .790 | 20.07 | 0.310 | 7.87 |
| 9S | 0.960 | 24.38 | 0.565 | 14.35 | 0.400 | 10.16 | 0.480 | 12.19 | 0.250 | 6.35 | 0.195 | 4.95 | .790 | 20.07 | 0.310 | 7.87 |
| 15P | 1.110 | 28.19 | 0.715 | 18.16 | 0.484 | 12.29 | 0.480 | 12.19 | 0.184 | 4.67 | 0.183 | 4.65 | .940 | 23.88 | 0.310 | 7.87 |
| 15S | 1.110 | 28.19 | 0.715 | 18.16 | 0.550 | 13.97 | 0.480 | 12.19 | 0.250 | 6.35 | 0.195 | 4.95 | .940 | 23.88 | 0.310 | 7.87 |
| 21P | 1.260 | 32.00 | 0.865 | 21.97 | 0.634 | 16.10 | 0.480 | 12.19 | 0.184 | 4.67 | 0.183 | 4.65 | 1.090 | 27.69 | 0.310 | 7.87 |
| 21S | 1.260 | 32.00 | 0.865 | 21.97 | 0.700 | 17.78 | 0.480 | 12.19 | 0.250 | 6.35 | 0.195 | 4.95 | 1.090 | 27.69 | 0.310 | 7.87 |
| 25P | 1.360 | 34.54 | 0.965 | 24.51 | 0.734 | 18.64 | 0.480 | 12.19 | 0.184 | 4.67 | 0.183 | 4.65 | 1.190 | 30.23 | 0.310 | 7.87 |
| 25S | 1.360 | 34.54 | 0.965 | 24.51 | 0.800 | 20.32 | 0.480 | 12.19 | 0.250 | 6.35 | 0.195 | 4.95 | 1.190 | 30.23 | 0.310 | 7.87 |
| 31P | 1.510 | 38.35 | 1.115 | 28.32 | 0.884 | 22.45 | 0.480 | 12.19 | 0.184 | 4.67 | 0.183 | 4.65 | 1.340 | 34.04 | 0.310 | 7.87 |
| 31S | 1.510 | 38.35 | 1.115 | 28.32 | 0.950 | 24.13 | 0.480 | 12.19 | 0.250 | 6.35 | 0.195 | 4.95 | 1.340 | 34.04 | 0.310 | 7.87 |
| 37P | 1.660 | 42.16 | 1.265 | 32.13 | 1.034 | 26.26 | 0.480 | 12.19 | 0.184 | 4.67 | 0.183 | 4.65 | 1.490 | 37.85 | 0.310 | 7.87 |
| 37S | 1.660 | 42.16 | 1.265 | 32.13 | 1.100 | 27.94 | 0.480 | 12.19 | 0.250 | 6.35 | 0.195 | 4.95 | 1.490 | 37.85 | 0.310 | 7.87 |

Notes

1. Mounting holes fitted with 2x .086-56 threaded insert, .15 min thread. (T3585-02CPF129).
2. Ground spring not available on cadmium plated assemblies.
3. Interface dimensions per MIL-DTL-83513.
4. Electrical performance:
I.R.: 5000 Megohms min at 100 VDC
D.W.V.: 200 VDC
5. Assembly to be identified with Glenair's name, part number, date code, and pin 1 identification.

Materials / Finishes

- Shell - Aluminum Alloy/See Chart
- Insulator - LCP/NA
- Contacts - Copper Alloy/Gold Plated
- Ground Spring - Stainless Steel/Gold Plated
- Socket Interfacial Seal: Fluorosilicone



240-078

Rear Panel Mount Micro-D Filter Connectors Condensed Board Right Angle Type



Glenair Filtered Right Angle Micro-D's provide EMI solutions in a miniaturized M83513 Micro-D connector. These connectors feature ceramic capacitor planar arrays and ferrite inductors.

Choose Pi or C Filter Arrays in eight filter classes and six layouts. Glenair filtered Micro-D connectors comply with applicable MIL-DTL-83513 requirements and are 100% intermateable with standard connectors.

.100" x .100" Board Spacing - These connectors are similar to "CBR" style Micro-D's and share the same board footprint, allowing retrofit to existing boards.

How To Order Micro-D Filtered Right Angle PCB

| Sample Part Number | 240-078 | -2 | -25 | S | C | F | -R1 | T | -.110 | N | N |
|------------------------|---|----|-----|---|---|---|-----|---|-------|---|---|
| Series | 240-078 | | | | | | | | | | |
| Shell Finish | Aluminum Shell 1 - Cadmium 2 - Nickel 5 - Gold 6 - Chem Film 33 - Nickel/PTFE | | | | | | | | | | |
| Contact Layout | 9, 15, 21, 25, 31, 37 (See Table II) | | | | | | | | | | |
| Contact Type | P - Pin S - Socket | | | | | | | | | | |
| Filter Type | C - C Filter P - Pi Filter | | | | | | | | | | |
| Filter Class | A, B, C, D, E, F, G, J (See Table I) | | | | | | | | | | |
| Hardware Option | Rear Panel Mount Hardware Option (See Note 1) R1 - 0.032" (0.8) Panel R2 - 0.047" (1.2) Panel R3 - 0.062" (1.6) Panel R4 - 0.093" (2.4) Panel R5 - 0.125" (3.2) Panel R6 - 0.080" (2.0) Panel | | | | | | | | | | |
| Insert | T - Threaded insert in board mount hole N - No threaded insert | | | | | | | | | | |
| Lead Length | .080 .110 .125 .140 .150 .172 .190 .250 | | | | | | | | | | |
| Plug EMI Ground Spring | G - Ground spring installed N - No ground spring (N applies to all receptacle assemblies) (See Note 2) | | | | | | | | | | |
| O-Ring | C - Conductive N - Non-Conductive (Nitrile) | | | | | | | | | | |

Specific Dimensions per Filter Type

| Shell Size | C FILTER | | | | | | PI FILTER | | | | | |
|------------|----------|-------|----------|-------|----------|-------|-----------|-------|----------|-------|----------|-------|
| | G MAX | | H ± .010 | | J ± .010 | | G MAX | | H ± .010 | | J ± .010 | |
| | in. | mm. | in. | mm. | in. | mm. | in. | mm. | in. | mm. | in. | mm. |
| 9P | 0.865 | 21.97 | 0.440 | 11.18 | 0.460 | 11.68 | 1.205 | 30.61 | 0.740 | 18.80 | 0.760 | 19.30 |
| 9S | 0.865 | 21.97 | 0.440 | 11.18 | 0.460 | 11.68 | 1.205 | 30.61 | 0.740 | 18.80 | 0.760 | 19.30 |
| 15P | 0.865 | 21.97 | 0.340 | 8.64 | 0.460 | 11.68 | 1.205 | 30.61 | 0.640 | 16.26 | 0.760 | 19.30 |
| 15S | 0.865 | 21.97 | 0.340 | 8.64 | 0.460 | 11.68 | 1.205 | 30.61 | 0.640 | 16.26 | 0.760 | 19.30 |
| 21P | 0.865 | 21.97 | 0.340 | 8.64 | 0.460 | 11.68 | 1.205 | 30.61 | 0.640 | 16.26 | 0.760 | 19.30 |
| 21S | 0.865 | 21.97 | 0.340 | 8.64 | 0.460 | 11.68 | 1.205 | 30.61 | 0.640 | 16.26 | 0.760 | 19.30 |
| 25P | 0.865 | 21.97 | 0.340 | 8.64 | 0.460 | 11.68 | 1.205 | 30.61 | 0.640 | 16.26 | 0.760 | 19.30 |
| 25S | 0.865 | 21.97 | 0.340 | 8.64 | 0.460 | 11.68 | 1.205 | 30.61 | 0.640 | 16.26 | 0.760 | 19.30 |
| 31P | 0.960 | 24.38 | 0.340 | 8.64 | 0.460 | 11.68 | 1.300 | 33.02 | 0.640 | 16.26 | 0.760 | 19.30 |
| 31S | 0.960 | 24.38 | 0.340 | 8.64 | 0.460 | 11.68 | 1.300 | 33.02 | 0.640 | 16.26 | 0.760 | 19.30 |
| 37P | 0.960 | 24.38 | 0.340 | 8.64 | 0.460 | 11.68 | 1.300 | 33.02 | 0.640 | 16.26 | 0.760 | 19.30 |
| 37S | 0.960 | 24.38 | 0.340 | 8.64 | 0.460 | 11.68 | 1.300 | 33.02 | 0.640 | 16.26 | 0.760 | 19.30 |
| 51P | 1.090 | 27.69 | 0.360 | 9.14 | 0.510 | 12.95 | 1.440 | 36.58 | 0.660 | 16.76 | 0.810 | 20.57 |
| 51S | 1.090 | 27.69 | 0.360 | 9.14 | 0.510 | 12.95 | 1.440 | 36.58 | 0.660 | 16.76 | 0.810 | 20.57 |

Rev. Oct. 14 2015

© 2013 Glenair, Inc.

High Performance Micro-D Connectors and Cables

U.S. CAGE Code 06324

Printed in U.S.A.

GLENAIR, INC. • 1211 AIR WAY • GLENDALE, CA 91201-2497 • 818-247-6000 • FAX 818-500-9912

www.glenair.com

G-28

E-Mail: sales@glenair.com

240-078

Rear Panel Mount Micro-D Filter Connectors
Condensed Board Right Angle Type



Micro-D Filter

Table II: Dimensional Table Dimensional Table



| Shell Size | A MAX | | B ± .003 | | C MAX | | D MAX | | E MAX | | F ± .004 | | K MAX | | L MAX | | M MAX | |
|------------|-------|-------|----------|-------|-------|-------|-------|------|-------|-------|----------|------|-------|-------|-------|-------|-------|-------|
| | in. | mm. | in. | mm. | in. | mm. | in. | mm. | in. | mm. | in. | mm. | in. | mm. | in. | mm. | in. | mm. |
| 9P | 0.965 | 24.51 | 0.565 | 14.35 | 0.333 | 8.46 | 0.184 | 4.67 | 0.485 | 12.32 | 0.183 | 4.65 | 0.335 | 8.51 | 0.310 | 7.87 | .790 | 20.07 |
| 9S | 0.965 | 24.51 | 0.565 | 14.35 | 0.400 | 10.16 | 0.250 | 6.35 | 0.485 | 12.32 | 0.195 | 4.95 | 0.335 | 8.51 | 0.310 | 7.87 | .790 | 20.07 |
| 15P | 1.115 | 28.32 | 0.715 | 18.16 | 0.483 | 12.27 | 0.184 | 4.67 | 0.485 | 12.32 | 0.183 | 4.65 | 0.335 | 8.51 | 0.310 | 7.87 | .940 | 23.88 |
| 15S | 1.115 | 28.32 | 0.715 | 18.16 | 0.551 | 14.00 | 0.250 | 6.35 | 0.485 | 12.32 | 0.195 | 4.95 | 0.335 | 8.51 | 0.310 | 7.87 | .940 | 23.88 |
| 21P | 1.265 | 32.13 | 0.865 | 21.97 | 0.633 | 16.08 | 0.184 | 4.67 | 0.485 | 12.32 | 0.183 | 4.65 | 0.335 | 8.51 | 0.310 | 7.87 | 1.090 | 27.69 |
| 21S | 1.265 | 32.13 | 0.865 | 21.97 | 0.701 | 17.81 | 0.250 | 6.35 | 0.485 | 12.32 | 0.195 | 4.95 | 0.335 | 8.51 | 0.310 | 7.87 | 1.090 | 27.69 |
| 25P | 1.365 | 34.67 | 0.965 | 24.51 | 0.733 | 18.62 | 0.184 | 4.67 | 0.485 | 12.32 | 0.183 | 4.65 | 0.335 | 8.51 | 0.310 | 7.87 | 1.190 | 30.23 |
| 25S | 1.365 | 34.67 | 0.965 | 24.51 | 0.801 | 20.35 | 0.250 | 6.35 | 0.485 | 12.32 | 0.195 | 4.95 | 0.335 | 8.51 | 0.310 | 7.87 | 1.190 | 30.23 |
| 31P | 1.515 | 38.48 | 1.115 | 28.32 | 0.883 | 22.43 | 0.184 | 4.67 | 0.485 | 12.32 | 0.183 | 4.65 | 0.430 | 10.92 | 0.310 | 7.87 | 1.340 | 34.04 |
| 31S | 1.515 | 38.48 | 1.115 | 28.32 | 0.951 | 24.16 | 0.250 | 6.35 | 0.485 | 12.32 | 0.195 | 4.95 | 0.430 | 10.92 | 0.310 | 7.87 | 1.340 | 34.04 |
| 37P | 1.665 | 42.29 | 1.265 | 32.13 | 1.033 | 26.24 | 0.184 | 4.67 | 0.485 | 12.32 | 0.183 | 4.65 | 0.430 | 10.92 | 0.310 | 7.87 | 1.490 | 37.85 |
| 37S | 1.665 | 42.29 | 1.265 | 32.13 | 1.101 | 27.97 | 0.250 | 6.35 | 0.485 | 12.32 | 0.195 | 4.95 | 0.430 | 10.92 | 0.310 | 7.87 | 1.490 | 37.85 |
| 51P | 1.665 | 42.29 | 1.215 | 30.86 | 1.033 | 26.24 | 0.224 | 5.69 | 0.530 | 13.46 | 0.183 | 4.65 | 0.560 | 14.22 | 0.394 | 10.01 | 1.440 | 36.58 |
| 51S | 1.665 | 42.29 | 1.215 | 30.86 | 1.101 | 27.97 | 0.293 | 7.44 | 0.530 | 13.46 | 0.195 | 4.95 | 0.560 | 14.22 | 0.394 | 10.01 | 1.440 | 36.58 |

Table I: Micro-D Filter Classes and Performance

| Filter Class | A | B | C | D | E | F | G | J |
|------------------|-------------|-------------|-------------|------------|-----------|----------|---------|--------|
| Capacitance (pF) | | | | | | | | |
| C Filter | 19000-28000 | 16000-22500 | 9000-16500 | 4000-6000 | 1650-2500 | 400-650 | 200-300 | 35-60 |
| Pi Filter | 38000-56000 | 32000-45000 | 18000-33000 | 8000-12000 | 3300-5000 | 800-1300 | 400-600 | 70-120 |

Notes

- Mounting holes fitted with 2x .086-56 threaded insert, .15 min thread. (T3585-02CPF129).
- Ground spring not available on cadmium plated assemblies.
- Interface dimensions per MIL-DTL-83513.
- Electrical performance:
I.R.: 5000 Megohms min at 100 VDC
D.W.V.: 200 VDC
- Assembly to be identified with Glenair's name, part number, date code, and pin 1 identification.
- See 240-034 for PCB layout

Materials / Finishes:

- Shell - Aluminum Alloy/See Chart
- Insulator - LCP/NA
- Contacts - Copper Alloy/Gold Plated
- Ground Spring - Stainless Steel/Gold Plated
- Socket Interfacial Seal: Fluorosilicone

G



247-379

Edge Board Micro-D Filter Connector



Glenair Edge Board Micro-D Filter Connectors provide EMI solutions in a miniaturized M83513 Micro-D connector. These connectors feature ceramic capacitor planar arrays and ferrite inductors.

Choose Pi or C Filter Arrays in eight filter classes and six layouts. Glenair filtered Micro-D connectors comply with applicable MIL-DTL-83513 requirements and are 100% intermateable with standard connectors.

Choose 9 to 37 Contacts, with standard cadmium or nickel plating on the connector housing or choose optional finishes such as gold or chem film.

How To Order Edge Board Micro-D Filter Connector

| Sample Part Number | 247-379 | -2 | -21 | P | C | A | PN |
|---------------------------------|--|----|---|---|---|--|----|
| Series | 247-379 | | | | | | |
| Shell Finish | Aluminum Shell 1 - Cadmium 2 - Electroless Nickel 5 - Gold | | | | | | |
| Contact Layout | 9, 15, 21, 25, 31, 37 (See Table II) | | | | | | |
| Contact Type | P - Pin S - Socket | | | | | | |
| Filter Type | C - C Filter P - Pi Filter N - No Filter | | | | | | |
| Filter Class | A, B, C, D, E, F, G, N, J (See Table I) | | | | | | |
| Hardware Option (See Note 1) | NN - No Jackpost, No Threaded Insert PN - Jackpost, No Threaded Insert NU - Threaded Insert Only, No Jackpost (see Table III) | | Rear Panel Mount Jackpost: R2U - 0.031" (0.6) Panel R3U - 0.047" (1.2) Panel R4U - 0.062" (1.6) Panel R5U - 0.094 (2.4) Panel R6U - 0.125" (3.2) Panel | | | Jackscrew Option: M - Hex Head Jackscrews S - Slot Head Jackscrews (See Table IV) | |

Table I: Micro-D Filter Classes and Performance

| Filter Class | A | B | C | D | E | F | G | J |
|------------------|-------------|-------------|-------------|------------|-----------|----------|---------|--------|
| Capacitance (pF) | | | | | | | | |
| C Filter | 19000-28000 | 16000-22500 | 9000-16500 | 4000-6000 | 1650-2500 | 400-650 | 200-300 | 35-60 |
| Pi Filter | 38000-56000 | 32000-45000 | 18000-33000 | 8000-12000 | 3300-5000 | 800-1300 | 400-600 | 70-120 |

Notes

- PC tail configuration intended for use with .062 board thickness
- Electrical Performance:
 - Insulation Resistance: 5000 megohms Min at 100 VDC
 - Dielectric Withstanding Voltage: 200 VDC

Materials / Finishes

- Shell - Aluminum Alloy/See Chart
- Insulator - LCP/NA
- Contacts - Copper Alloy/Gold Plated
- Ground Spring - Stainless Steel/Gold Plated
- Socket Interfacial Seal: Fluorosilicone

247-379 Edge Board Micro-D Filter Connector



Micro-D Filter

Table II: Dimensions



| Shell Size | A $\pm.010$ | | B Max | | C $\pm.003$ | | D Max | | F $\pm.004$ | | H Max | |
|------------|-------------|-------|-------|-------|-------------|-------|-------|------|-------------|------|-------|-------|
| | in. | mm | in. | mm | in. | mm | in. | mm | in. | mm | in. | mm |
| 9P | 0.785 | 19.94 | 0.333 | 8.46 | 0.565 | 14.35 | 0.184 | 4.67 | 0.183 | 4.65 | 0.400 | 10.16 |
| 9S | 0.785 | 19.94 | 0.400 | 10.16 | 0.565 | 14.35 | 0.250 | 6.35 | 0.195 | 4.95 | 0.400 | 10.16 |
| 15P | 0.935 | 23.75 | 0.483 | 12.27 | 0.715 | 18.16 | 0.184 | 4.67 | 0.183 | 4.65 | 0.550 | 13.97 |
| 15S | 0.935 | 23.75 | 0.551 | 14.00 | 0.715 | 18.16 | 0.250 | 6.35 | 0.195 | 4.95 | 0.550 | 13.97 |
| 21P | 1.085 | 27.56 | 0.633 | 16.08 | 0.865 | 21.97 | 0.184 | 4.67 | 0.183 | 4.65 | 0.700 | 17.78 |
| 21S | 1.085 | 27.56 | 0.701 | 17.81 | 0.865 | 21.97 | 0.250 | 6.35 | 0.195 | 4.95 | 0.700 | 17.78 |
| 25P | 1.185 | 30.10 | 0.733 | 18.62 | 0.965 | 24.51 | 0.184 | 4.67 | 0.183 | 4.65 | 0.800 | 20.32 |
| 25S | 1.185 | 30.10 | 0.801 | 20.35 | 0.965 | 24.51 | 0.250 | 6.35 | 0.195 | 4.95 | 0.800 | 20.32 |
| 31P | 1.335 | 33.91 | 0.883 | 22.43 | 1.115 | 28.32 | 0.184 | 4.67 | 0.183 | 4.65 | 0.950 | 24.13 |
| 31S | 1.335 | 33.91 | 0.951 | 24.16 | 1.115 | 28.32 | 0.250 | 6.35 | 0.195 | 4.95 | 0.950 | 24.13 |
| 37P | 1.485 | 37.72 | 1.033 | 26.24 | 1.265 | 32.13 | 0.184 | 4.67 | 0.183 | 4.65 | 1.100 | 27.94 |
| 37S | 1.485 | 37.72 | 1.101 | 27.97 | 1.265 | 32.13 | 0.250 | 6.35 | 0.195 | 4.95 | 1.100 | 27.94 |



247-379 Edge Board Micro-D Filter Connector

Micro-D Filtered Edge Board Connector - Plug



Pad Height and Width



Size 25P



Size 9P



Size 31P



Size 15P



Size 37P



Size 21P

247-379 Edge Board Micro-D Filter Connector



Micro-D Filtered Edge Board Connector - Socket



Pad Height and Width



Size 25S



Size 9S



Size 31S



Size 15S

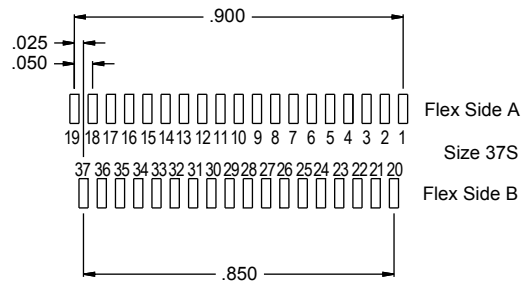

Size 37PS



Size 21S





2470-1048 Combo Micro-D Filter Connector for Power Applications

2470-1048 Combo Micro-D Filter Connectors combine the size and weight advantages of a Micro-D connector with the added ability to handle higher power needs. Available in C filter configurations, with solder cup contact termination, PC tails or pre-wired.



Notes

- Electrical Performance:
 - Insulation Resistance: 5000 megohms Min at 100 VDC
 - Dielectric Withstand Voltage: 250 VDC
 - Capacitance: pins A, B, C, D, 3, 5, 9 and 12 to be 38–56 nF Pi filter (filter class A). All remaining signal lines are fitted with dummy contacts with no termination.
 - Signal current rating: 3 Amps Max
 - Power current rating: 7.5 Amps Max
- Assembly to be identified with Glenair's name, part number and date code space permitting.

Materials / Finishes

- Shell - Aluminum Alloy/See Chart
- Insulator - LCP/NA
- Contacts - Copper Alloy/Gold Plated
- Ground Spring - Stainless Steel/Gold Plated
- Socket Interfacial Seal: Fluorosilicone

249-EMITS-MICRO EMITS EMI Troubleshooter Micro-D Edition



EMITS is designed for fast troubleshooting of EMI issues. Reduce time and money spent at test labs debugging EMI problems with this portable kit. Lightweight, high-strength anodized aluminum case comes supplied with low, medium, and high capacitance filters in size 9 through 37 position Micro-Ds, and a hand-held LCR meter.



| How To Order EMITS | | |
|--------------------|--|----|
| Sample Part Number | 249-EMITS-MICRO | -2 |
| Series | 249-EMITS-MICRO | |
| Plating | 2 - Aluminum / Electroless Nickel 5 - Aluminum / Gold | |



| Item | Part Number* | Qty |
|------|------------------------------|-----|
| 1 | 240-033-X-9PSCEN | 1 |
| 2 | 240-033-X-9PSCAN | 1 |
| 3 | 240-033-X-9PSPAN | 1 |
| 4 | 240-033-X-15PSCEN | 1 |
| 5 | 240-033-X-15PSCAN | 1 |
| 6 | 240-033-X-15PSPAN | 1 |
| 7 | 240-033-X-21PSCEN | 1 |
| 8 | 240-033-X-21PSCAN | 1 |
| 9 | 240-033-X-21PSPAN | 1 |
| 10 | 240-033-X-25PSCEN | 1 |
| 11 | 240-033-X-25PSCAN | 1 |
| 12 | 240-033-X-25PSPAN | 1 |
| 13 | 240-033-X-31PSCEN | 1 |
| 14 | 240-033-X-31PSCAN | 1 |
| 15 | 240-033-X-31PSPAN | 1 |
| 16 | 240-033-X-37PSCEN | 1 |
| 17 | 240-033-X-37PSCAN | 1 |
| 18 | 240-033-X-37PSPAN | 1 |
| 19 | 738X CASE | 1 |
| 20 | U1733C LCR METER | 1 |
| 21 | 7278A35 TOOL | 1 |
| 22 | 5274T62 VIAL | 2 |
| 23 | 249-033 JACK SCREW/JACK POST | 18 |

* See 240-033 for filter connector details



GLASS-TO-METAL
SEAL

MIL-DTL-83513

GLASS-SEALED
Hermetic
CONNECTORS

Micro-D hermetic connectors for high pressure/low leakage applications



MIL-DTL-83513 type Micro-D hermetic connectors feature machined Kovar® shells and contacts with moisture resistant plating and paired with high performance contacts that make these connectors an excellent solution for high pressure and low leakage applications where vibration and shock are a concern. Hermetic Micro-D Connectors are rated at 1×10^{-7} cc/helium per second and are available in solder cup, PC tail and prewired pigtail termination options. Choose from 9 shell sizes to accommodate 9 to 100 sockets. Glenair Micro-D hermetic connectors are in stock and available for immediate shipment.



Glenair®

Glenair, Inc.

1211 Air Way
Glendale, CA
91201-2497

818-247-6000
sales@glenair.com
www.glenair.com

Section H Micro-D Glass-Sealed Hermetic Connectors



Product Selection Guide



Glenair's Hermetic Micro-D Connectors feature fused glass insulators to provide an airtight seal. These connectors are 100% tested to meet a maximum leak rate of 1×10^{-7} cc's per second of helium.

Matched Kovar® Seal – The shells and contacts are machined from Kovar®, an iron-nickel-cobalt alloy which forms a chemical bond with the vitreous glass insulator. The contacts are gold-plated and the shell is nickel-plated.

Choose Solder Cup, PC Tails or Pre-Wired in two styles: panel mount for soldering or o-ring mount.

Solder Mount
Hermetic
Solder Cup Contacts
Page H-6



Solder Mount Hermetic

These Kovar® alloy connectors are available in three styles: solder cup contacts, PC tail contacts or pre-wired and epoxy-sealed. Socket contacts are Kovar® alloy with gold plating. These connectors can be front- or rear-panel mounted. Installation requires soldering, brazing or welding to the bulkhead. Helium leak rate is 1×10^{-7} cc's per second.

Solder Mount
Hermetic
PC Tail Contacts
Page H-6



Front Panel
Mount
Shell Size 9-21
Hermetic
Page H-9



Front Panel Mount Hermetic

These Kovar® alloy connectors are available with 2 or 3 row solder cup or PC tail, and socket termination options

Front Panel
Mount
Shell Size 37
Hermetic
Page H-8



RPM Hermetic
Page H-10



Hermetic for Rear-Panel Mounting

Avoid the expense of soldering with this o-ring version. Blind tapped mounting holes and integral jackposts provide easy installation. Three termination options are available: solder cup, PC tails, or pre-wired to protect and insulate the solder joints.



A Full Range of MIL-DTL-83513 Type Micro-D Hermetic Connectors

Product Applications

Glenair MIL-DTL-83513 type Micro-D hermetic connectors are ideal for high-pressure/ low-leakage applications where size, weight and vibration resistance are a critical concern. Sophisticated electronics enclosures, vacuum chambers and cryogenic equipment all benefit from the airtight seal and moisture resistant plating found on Glenair hermetic Micro-D connectors. Solder mount, and rear panel O-ring shell styles are available to meet a variety of design requirements.

Materials

Kovar®—an iron nickel alloy—is used in both the shells and contacts, and provides a chemical bond with the glass insulator for maximum hermeticity. Shells are then plated with nickel after the glass insulator is fired to enhance corrosion resistance. Contacts are plated with gold to ensure superior electrical conductivity.

Connectors are offered with a minimum of 9 sockets, up to a maximum of 100 sockets—in two, three and four row solder cup and pigtail configurations. Fluorosilicone rubber interfacial seals and O-rings ensure positive sealing with plug connectors and panels. Gold plated Kovar® socket contacts boast superior vibration resistance when used in conjunction with Glenair's innovative TwistPin contact system in the plug.

Same-Day Inventory

Because Glenair makes all its hermetic connectors in-house, including the machining of shells, molding of interfacial seals and firing of hermetic components, we can offer you outstanding availability on stock products and fast turnaround on special orders.

Catalog contents—including part numbers, materials and dimensions—are accurate to the best of our ability when we go to print. Even so, customers are advised to consult the factory for the latest specifications, particularly to confirm critical dimensions such as connector lengths, threads, and so on. Corrected content is posted immediately to www.glenair.com



**Solder Mount and Rear
Panel Sealing Options**

**9 to 100 Sockets in 9 Shell
Sizes**

**Space Grade Special
Screening Available**

**1×10^{-7} cc/Helium per
Second Leakage Rate**

**Solder Cup, PC Tail and Pre-
Wired Pigtail Termination
Options**

**Machined Kovar® Shells
and Contacts with Moisture
Resistant Plating**

Micro-D Hermetic Connectors

Hermeticity is defined as "the state or condition of being airtight". Sophisticated military electronics enclosures can experience electrical failure from ingress of moisture. System engineers can design the enclosure to withstand exposure to moisture and condensation by using "moisture-hardened" components and conformal coatings, but often the most practical approach is to install hermetically sealed electrical I/O connectors. Glass-to-metal seals provide assurance that, over the life of the enclosure, the accumulated amount of water vapor inside the box will not exceed the amount necessary to form condensation. Other applications for Micro-D hermetic connectors include vacuum chambers, cryogenics, and enclosures filled with inert gas.

Kovar® Alloy

Glenair's hermetic Micro-D shells and contacts are made from a special alloy called Kovar®, an iron-nickel-cobalt alloy consisting of 54% Fe, 29% Ni, and 17% Co. This alloy is covered by SAE specification AMS-I-23011. Kovar has a relatively low coefficient of thermal expansion.

Matched Glass-To-Metal Seals

Matched seals rely on a chemical bond between the metal and the glass. Kovar contacts and shells are first exposed to high temperatures in order to develop an oxide coating. Then, the borosilicate glass and metal components are assembled with fixtures and are fused in a firing furnace at 900° C. A strong chemical bond is created between the metal and glass. Unlike compression seals which rely on different thermal coefficients of expansion between the glass and metal, a matched seal offers better resistance to stress from thermal extremes.

Hermetic Testing

All Micro-D hermetic connectors are 100% tested prior to shipment. A helium leak test is performed to certify the hermetic seal. This test is conducted by inducing a 1 ATM vacuum on one side of the connector. Helium gas is released on the other side, and a mass spectrometer "counts" the number of helium molecules that penetrate the connector seal. Helium leak testing takes advantage of the small size of a helium molecule compared to air or water vapor. Helium is inert, rare in our atmosphere, and is easy to detect with a mass spectrometer.

Micro-D Hermetic Plating Options

Unlike regular connectors which are plated as components prior to assembly, hermetic connectors are electroplated after the parts are fired and cleaned of oxides. Typically the contacts are gold-plated and the connector shell is nickel-plated.

Connector Installation

Hermetic connectors are typically soldered or welded into panels or bulkheads. Laser welding is a good option if the connector is mounted onto a Kovar or stainless steel panel. If the panel is aluminum alloy, then soldering is recommended. Micro-D's with o-ring seals offer another alternative. O-rings, when installed properly, will provide a very low permeability seal. The seating surface must be free from scratches or imperfections. A 32 finish is acceptable, but a 16 finish is preferred. The o-ring can be coated with a light coat of vacuum grease.





Micro-D Hermetic Connectors General Information

Micro-D Hermetic Connector Design Notes

“Why can't I get a hermetic Micro-D with pin contacts instead of sockets?”

The Micro-D TwistPin contact cannot be made from the materials that are required for hermetic contacts. Hermetic contacts are made from ferrous alloys such as Kovar® or Alloy 52. These alloys do not have spring properties. The Micro-D TwistPin contact is made from spring-temper

beryllium copper. The Micro-D socket contact is a cylinder and does not provide any spring force, so Micro-D hermetic connectors are always receptacle connectors with socket contacts.

“What about high pressure?”

“What is the maximum recommended pressure rating for a hermetic Micro-D?”

Glenair hermetic Micro-D's are built to safely withstand 1000 PSI of hydrostatic pressure in an open face (unmated) condition.

MICRO-D CONTACT ARRANGEMENTS (FACE VIEW SOCKET CONNECTOR)



Performance Specifications

| | |
|--|---|
| Current Rating | 1.5 AMP |
| DWV | 150 VAC |
| Working Voltage | 100 VDC |
| IR | 5000 Megohms Minimum |
| Contact Resistance | 40-50 Milliohms Maximum |
| Hermeticity | Maximum Helium Leak Rate 1 X 10 ⁻⁷ cc's per Second at One Atmosphere |
| Operating Temp. | -55° C. to +125° C. |
| Shock | 50 g. |
| Vibration | 20 g. |
| Outgassing | Meets NASA Outgassing Requirements (mod code 429) |
| Mating Force | (10 Ounces) X (# of Contacts) |
| For additional performance requirements, please refer to MIL-DTL-83513 | |

Materials and Finishes

| | |
|------------------|---|
| Connector Shell | Kovar® Alloy in Accordance With SAE AMS-I-23011 Class 1, Plated with Electrodeposited Nickel In Accordance With SAE-AMS-QQ-N-290 Class 2, 0.0002-0.0003 Inches Thick. |
| Insulator | Borosilicate Glass |
| Interfacial Seal | Fluorosilicone Rubber, Blue |
| Socket Contact | Kovar® Alloy in Accordance With SAE AMS-I-23011 Class 1, Gold Plated In Accordance With ASTM B 488 Type II, Class 1.27 (50 microinches minimum) over Nickel Underplate in Accordance With SAE-AMS-QQ-N-290 Class 2. |
| O-Ring | Fluorosilicone Rubber, Blue |
| Encapsulant | Epoxy |

MICRO-D PCB FOOTPRINTS (COMPONENT SIDE OF BOARD)



9 Socket



15 Socket



21 Socket

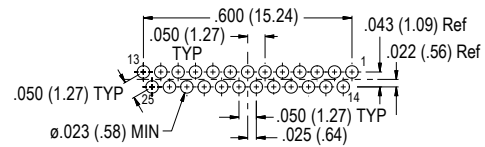

25 Socket



31 Socket



37 Socket



51 Socket (Standard 3 Row)



51 Socket (Special 2 Row)



100 Socket

| Connector Weights For 177-140H Hermetic Solder Mount | | |
|--|------------|------|
| Maximum Weight In Grams | | |
| Layout | Solder Cup | PCB |
| 9 | 4.7 | 4.5 |
| 15 | 7.1 | 6.8 |
| 21 | 8.2 | 8.0 |
| 25 | 8.7 | 8.4 |
| 31 | 9.5 | 9.2 |
| 37 | 10.8 | 10.4 |

| Hermetic Leak Rate Mod Codes | |
|------------------------------|--|
| Designator | Required Leak Rate |
| -585A | 1 x 10 ⁻¹⁰ cc Helium per second |
| -585B | 1 x 10 ⁻⁹ cc Helium per second |
| -585C | 1 x 10 ⁻⁸ cc Helium per second |



177-140H Solder Cup or PC Tail and 177-704H Insulated Wire Micro-D Hermetic Connectors Solder, Braze or Weld Mount



**MATES
WITH
All** **83513**
Pin
Connectors

Solder, Braze, or Weld these 177-140 and 704 Hermetic Micro-D connectors. Featuring a matched glass-to-metal seal, these socket receptacles are designed for panel mounting.

Kovar® Shells and Contacts comply with applicable MIL-DTL-83513 space requirements and are 100% intermateable with standard connectors.

Choose 9 to 100 Contacts, with gold-plated contacts and nickel-plated shells. These connectors feature integral female jackposts.

How To Order Hermetic Micro-D Connectors with Solder Cups

| | | | | |
|---------------------------|--|-----------------|-----------|-----------|
| Sample Part Number | | 177-140H | 31 | SS |
| Series | 177-140H Hermetic Micro-D | | | |
| Number of Contacts | 9, 15, 21, 25, 31, 37, 51-3, 51-2, 100 (Table I) | | | |
| Termination Type | SS - Solder Cup, Socket SP - PC Tail, Socket | | | |

Notes

- Use of Threaded helical coil insert manufacturers option
- Glenair's 177-140 hermetic socket connector mates with all standard MIL-DTL-83513 pin connectors (MWDM series).
- Connector may be back potted
- Use threaded helical coil insert manufactures option.

- Connector may be back potted
- Performance:
 - Hermeticity 1×10^{-6} scche/sec @ 1 atmosphere differential
 - Dielectric withstanding voltage: sea level 150 vac
 - Insulation resistance: 5000 megohms min.

- Material/finish
 - Shell: kovar alloy/electro-deposited nickel
 - Socket contacts: Kovar® alloy/ gold plate
 - Insulator: borosilicate glass
 - Interfacial seal, o-ring: fluorosilicone/n.a.
 - Potting: epoxy

How To Order Hermetic Micro-D Connectors with Insulated Wire

| | | | | | | | | |
|---------------------------|--|-----------------|-----------|----------|---|----------|----------|------------|
| Sample Part Number | | 177-704H | 25 | S | 6 | K | 1 | -18 |
| Series | 177-704H Hermetic Micro-D with Insulated Wire | | | | | | | |
| Number of Contacts | 9, 15, 21, 25, 31, 37, 51-3, 51-2, 100 (Table I) | | | | | | | |
| Contact Type | S - Socket Contacts, Pre-Wired | | | | | | | |
| Wire Gage (AWG) | 6 - 26 8 - #28 0 - #30 | | | | | | | |
| Wire Type | K - M22759/11 600 Vrms Fluoropolymer (TFE) (Not Available in #30 AWG) | | | | J - M22759/33 600 Vrms Modified Cross-Linked Tefzel® (ETFE) | | | |
| Wire Color | 1 - White 2 - Yellow 5 - Color-Coded Stripes Per MIL-STD-681 (#26 gage only) 7 - Ten Color Repeat | | | | | | | |
| Wire Length Inches | 18 - Wire Length In Inches. "18" Specifies 18 Inches. | | | | | | | |

Notes

- Glenair 177-704 hermetic socket connector mates with all standard MIL-DTL-83513 pin connectors (MWDM series).
- Performance:
 - Hermeticity 1×10^{-6} scche/sec @ 1 atmosphere differential
 - Dielectric withstanding voltage: sea level 150 vac
 - Insulation resistance: 5000 megohms min.
- Connector may be back potted.
- Use threaded helical coil insert manufactures option.

- Material/finish
 - Shell: kovar alloy/electro-deposited nickel
 - Socket contacts: Kovar® alloy/ gold plate
 - Insulator: borosilicate glass
 - Interfacial seal, o-ring: fluorosilicone/n.a.
 - Potting: epoxy

177-140H Solder Cup or PC Tail and 177-704H Insulated Wire Micro-D Hermetic Connectors Solder, Braze or Weld Mount



Micro-D
Hermetic

Table I: Dimensions



| Layout | A Max. | | B | | C MAX. | | D Max. | | E Max. | | F | | G Max. | | H | | J | |
|-----------|--------|-------|------------|------------|------------|------------|--------|------|--------|-------|------------|------------|--------|-------|------------|------------|------------|------------|
| | In. | mm. | In. ± .005 | mm. ± 0.13 | In. ± .005 | mm. ± .013 | In. | mm. | In. | mm. | In. ± .004 | mm. ± 0.10 | In. | mm. | In. ± .004 | mm. ± 0.10 | In. ± .004 | mm. ± 0.10 |
| 9S | .785 | 19.94 | .565 | 14.35 | .695 | 14.35 | .250 | 6.35 | .310 | 7.87 | .195 | 4.95 | .394 | 10.01 | .398 | 10.11 | .268 | 6.81 |
| 15S | 1.030 | 26.16 | .715 | 18.16 | .855 | 21.71 | .250 | 6.35 | .425 | 10.80 | .195 | 4.95 | .394 | 10.01 | .535 | 13.59 | .255 | 6.48 |
| 21S | 1.180 | 29.97 | .865 | 21.97 | 1.005 | 25.53 | .250 | 6.35 | .425 | 10.80 | .195 | 4.95 | .394 | 10.01 | .750 | 19.05 | .255 | 6.48 |
| 25S | 1.280 | 32.51 | .965 | 24.51 | 1.105 | 28.06 | .250 | 6.35 | .425 | 10.80 | .195 | 4.95 | .394 | 10.01 | .785 | 19.94 | .255 | 6.48 |
| 31S | 1.430 | 36.32 | 1.115 | 28.32 | 1.255 | 31.88 | .250 | 6.35 | .425 | 10.80 | .195 | 4.95 | .394 | 10.01 | .935 | 23.75 | .255 | 6.48 |
| 37S | 1.580 | 40.13 | 1.265 | 32.13 | 1.425 | 36.20 | .250 | 6.35 | .425 | 10.80 | .195 | 4.95 | .394 | 10.01 | 1.085 | 27.56 | .255 | 6.48 |
| 51S 2 Row | 1.930 | 49.02 | 1.615 | 45.08 | 1.775 | 45.09 | .250 | 6.35 | .425 | 10.80 | .199 | 5.05 | .394 | 10.01 | 1.435 | 36.45 | .250 | 6.35 |
| 51S 3 Row | 1.530 | 38.86 | 1.215 | 30.86 | 1.361 | 34.57 | .310 | 7.87 | .468 | 11.89 | .199 | 5.05 | .394 | 10.01 | 1.032 | 33.101 | .300 | 7.62 |
| 100S | 2.260 | 57.40 | 1.800 | 45.72 | 2.010 | 51.05 | .330 | 8.38 | .517 | 13.13 | .199 | 5.05 | .394 | 10.01 | 1.765 | 44.8 | .355 | 9.0 |

| TABLE II | | | | | | | | | |
|----------|-----------|-------------|-----------|-----------|------|-------------|-------------|-----------|------------|
| SIZE | F DIM | | G DIM | | SIZE | F DIM | | G DIM | |
| | in | mm | in | mm | | in | mm | in | mm |
| 9 | .410/.405 | 10.41/10.29 | .280/.275 | 7.11/6.99 | 37 | 1.100/1.095 | 27.94/27.81 | .270/.265 | 6.86/6.73 |
| 15 | .550/.545 | 13.97/13.84 | .270/.265 | 6.86/6.73 | 51 | 1.045/1.040 | 26.54/26.42 | .310/.305 | 7.87/7.75 |
| 21 | .765/.760 | 20.32/20.19 | .270/.265 | 6.86/6.73 | 51-2 | 1.450/1.445 | 36.83/36.70 | .270/.265 | 6.86/6.73 |
| 25 | .800/.795 | 20.32/20.19 | .270/.265 | 6.86/6.73 | 100 | 1.780/1.775 | 45.21/45.09 | .370/.365 | 9.40/9.271 |
| 31 | .950/.945 | 24.13/24.00 | .270/.265 | 6.86/6.73 | | | | | |





177-232 MIL-DTL-83513 Type Micro-D Hermetic Connectors Size 37 Front Mount

Conductive Elastomer O-Ring eliminates the cost of soldering the connector to a bulkhead.

Kovar® Shells and Contacts comply with applicable MIL-DTL-83513 requirements and are 100% intermateable with standard connectors.

| How To Order PC Tail Connectors |
|--|
| Series |
| 177-232 |
| Micro-D Hermetic Socket Shell, Size 37, Front Mount |
| Sample Part Number |
| 177-232 |



Notes

- Glenair's 177-232 hermetic socket connector mates with all standard MIL-DTL-83513 37 pin connectors (MWDM series).
- Performance: hermeticity: 1×10^{-8} scche/sec @ 1 atmosphere
differential dielectric withstanding voltage: sea level 150 vac
insulation resistance: 5000 megohms max.
- Assembly to be identified with Glenair's name, part number and date code space permitting.
- Assembly to be identified with Glenair's name, part number, and date code, space permitting

Material/finish

- Shell: Kovar® alloy/electro-deposited nickel
Socket contacts: Kovar® alloy/ gold plate
Interfacial seal: fluorosilicone elastomer
- O-ring: conductive elastomer, chomerics 10-00-2068-1215
- Mounting screws:
18-8 Cres, #2-56 x .187 Button-head socket head cap screw supplied with connector (2 each)

177-859
MIL-DTL-83513 Type Micro-D Hermetic Connectors
 Shell Size 9-21 Front Panel Mount



Micro-D
 Hermetic



Fluorosilicone O-Ring eliminates the cost of soldering the connector to a bulkhead.

Kovar® Shells and Contacts comply with applicable MIL-DTL-83513 requirements and are 100% intermateable with standard connectors.

| How To Order Hermetic Micro-D Connectors with Solder Cup or PC Tail | | | | | |
|---|---------------------------------|----------------------|----------------------------|----------------------|------------------------|
| Sample Part Number | | 177-859 | 15 | -1 | |
| Series | 177-859 Micro-D Hermetic | | | | |
| Number of Contacts | -9, -15, -21 (Table II) | | | | |
| O-Ring Material | -1 - Viton | -02 - Nitrile | -3 - Fluorosilicone | -4 - Silicone | -5 - Conductive |

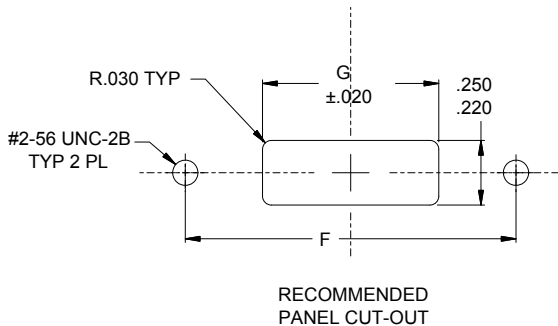

| Table II: Contact Dimensions | | | | | | | |
|------------------------------|-------|-------|-------|-------|-------|-------|-------|
| Layout. | A | B | C | D | E | F | G |
| 9 | 1.176 | 0.565 | 0.380 | 0.600 | 0.776 | 0.976 | 0.500 |
| 15 | 1.326 | 0.715 | 0.530 | 0.750 | 0.926 | 1.126 | 0.650 |
| 21 | 1.416 | 0.865 | 0.680 | 0.840 | 1.016 | 1.216 | 0.725 |

Notes

- Conductive o-ring material - chomerics 1215 or equivalent.
- Glenair's 177-859 hermetic socket connector mates with all standard MIL-DTL-83513 pin connectors (mwdm series).
- Performance:
 - Hermeticity: 1×10^{-8} Scche/sec @ 1 atmosphere differential
 - Dielectric withstanding voltage: sea level 150 vac
 - Insulation resistance: 5000 megohms max.
 - Assembly to be identified with Glenair's name, part number and date code space permitting.

Material/finish

- Shell: Kovar alloy/electro-deposited nickel socket cocontacts: Kovar® alloy/gold plate interfacial
- Seal: fluorosilicone elastomer



177-705H Solder Cup or PC Tail and 177-706H Insulated Wire Micro-D Hermetic Connectors Rear Panel Mount



**MATES
WITH
ALL** **83513**
Pin
Connectors

Fluorosilicone O-Ring eliminates the cost of soldering the connector to a bulkhead.

Kovar® Shells and Contacts comply with applicable MIL-DTL-83513 requirements and are 100% intermateable with standard connectors.

Solder Cup, PC Tail or Pre-Wired and Fully Potted Suitable for #26 gage wire or smaller, solder cup versions feature gold-plated contacts. Choose PC tails for attachment to flex circuits or rigid boards. Solder cup versions are also available pre-wired and potted.

How To Order Hermetic Micro-D Connectors with Solder Cup or PC Tail

| | | | | |
|---------------------------|--|-----------|----------------------|----------|
| Sample Part Number | 177-705 H | 15 | SS | U |
| Series | 177-705H Hermetic Micro-D | | | |
| Number of Contacts | 9, 15, 21, 25, 31, 37, 51-2, 51-3, 100 (Table I) | | | |
| Contact Type | SS - Solder Cup, Socket | | SP - PC Tail, Socket | |
| Mounting Threads | U - #4 - 40 UNC M - M3 Metric | | | |

H

How To Order Hermetic Micro-D Connectors with Insulated Wire

| | | | | | | | |
|---------------------------|---|-----------|----------|----------|----------|----------|------------|
| Sample Part Number | 177-706H | 25 | S | 6 | K | 1 | -18 |
| Series | 177-706H Hermetic Micro-D | | | | | | |
| Number of Contacts | 9, 15, 21, 25, 31, 37, 51-2, 51-3, 100 (Table I) | | | | | | |
| Contact Type | S - Socket Contacts, Pre-Wired | | | | | | |
| Wire Gage (AWG) | 6 - #26 8 - #28 0 - #30 | | | | | | |
| Wire Type | K - M22759/11 600 Vrms Fluoropolymer (TFE) (Not Available in #30 AWG) J - M22759/33 600 Vrms Modified Cross-Linked Tefzel (ETFE) | | | | | | |
| Wire Color | 1 - White, 2 - Yellow, 5 - Color-Coded Stripes Per MIL-STD-681 (#26 gage only) 7 - Ten Color Repeat | | | | | | |
| Wire Length Inches | 18 - Wire Length In Inches. "18" Specifies 18 Inches. | | | | | | |

177-705H Solder Cup or PC Tail and 177-706H Insulated Wire Micro-D Hermetic Connectors Rear Panel Mount



Micro-D
Hermetic

Table I: Dimensions



| Layout | A Max. | | B Max | | C Max. | | D | | E Max. | | F Max. | | G | | H Max. | | J | | K | | L Max. | |
|------------------|--------|-------|------------|------------|--------|-------|------------|------------|--------|------|--------|-------|------------|------------|--------|-------|-------|-------|------------|------------|--------|------|
| | In. | mm. | In. ± .005 | mm. ± 0.13 | In. | mm. | In. ± .003 | mm. ± 0.08 | In. | mm. | In. | mm. | In. ± .004 | mm. ± 0.10 | In. | mm. | In. | mm. | In. ± .004 | mm. ± 0.10 | In. | mm. |
| 9S | 1.488 | 37.80 | 1.011 | 25.67 | .728 | 18.49 | .565 | 14.35 | .250 | 6.35 | .675 | 17.14 | .195 | 4.95 | .526 | 13.36 | 1.254 | 31.85 | .257 | 6.89 | .358 | 9.09 |
| 15S | 1.638 | 41.61 | 1.161 | 29.48 | .878 | 22.30 | .715 | 18.16 | .250 | 6.35 | .675 | 17.14 | .195 | 4.95 | .526 | 13.36 | 1.414 | 36.91 | .257 | 6.89 | .358 | 9.09 |
| 21S | 1.788 | 45.42 | 1.311 | 33.29 | 1.028 | 26.12 | .865 | 21.97 | .250 | 6.35 | .675 | 17.14 | .195 | 4.95 | .526 | 13.36 | 1.564 | 39.72 | .257 | 6.89 | .358 | 9.09 |
| 25S | 1.888 | 47.96 | 1.411 | 35.83 | 1.128 | 28.65 | .965 | 24.51 | .250 | 6.35 | .675 | 17.14 | .195 | 4.95 | .526 | 13.36 | 1.664 | 42.26 | .257 | 6.89 | .358 | 9.09 |
| 31S | 2.038 | 51.76 | 1.561 | 39.64 | 1.278 | 32.46 | 1.115 | 28.32 | .250 | 6.35 | .675 | 17.14 | .195 | 4.95 | .526 | 13.36 | 1.814 | 46.07 | .257 | 6.89 | .358 | 9.09 |
| 37S | 2.188 | 55.57 | 1.711 | 43.45 | 1.428 | 36.27 | 1.265 | 32.13 | .250 | 6.35 | .675 | 17.14 | .195 | 4.95 | .526 | 13.36 | 1.984 | 50.39 | .257 | 6.89 | .358 | 9.09 |
| 51S 2 Row | 2.538 | 64.47 | 2.061 | 52.35 | 1.778 | 45.16 | 1.615 | 41.02 | .250 | 6.35 | .675 | 17.14 | .195 | 4.95 | .526 | 13.36 | 2.334 | 59.28 | .257 | 6.89 | .358 | 9.09 |
| 51S 3 Row | 2.138 | 54.30 | 1.661 | 42.19 | 1.378 | 35.00 | 1.215 | 30.86 | .310 | 7.87 | .715 | 18.16 | .195 | 4.95 | .526 | 13.36 | 1.920 | 48.77 | .257 | 6.89 | .358 | 9.09 |
| 100 S | 2.820 | 71.63 | 2.312 | 58.72 | 2.002 | 50.85 | 1.800 | 45.72 | .330 | 8.38 | .795 | 20.19 | .195 | 4.95 | .599 | 15.21 | 2.569 | 65.25 | .257 | 6.89 | .358 | 9.09 |

H



**177-705H Solder Cup or PC Tail and
177-706H Insulated Wire Micro-D Hermetic Connectors
Rear Panel Mount**

Table II: Panel Cutout Dimensions for 177-705 and 177-706



H

| Layout | A | | B | | C | |
|-----------------|------------|------------|----------------|----------------|----------------|-----------------|
| | In. ± .003 | mm. ± 0.08 | In. +.005/-0.0 | mm. +0.13/-0.0 | In. +.005/-0.0 | mm. + 0.13/-0.0 |
| 9 | 1.011 | 25.69 | .731 | 18.56 | .252 | 6.40 |
| 15 | 1.161 | 29.50 | .881 | 22.37 | .252 | 6.40 |
| 21 | 1.311 | 33.31 | 1.031 | 26.18 | .252 | 6.40 |
| 25 | 1.411 | 35.85 | 1.131 | 28.72 | .252 | 6.40 |
| 31 | 1.561 | 39.66 | 1.281 | 32.53 | .252 | 6.40 |
| 37 | 1.711 | 43.47 | 1.431 | 36.34 | .252 | 6.40 |
| 51 2 row | 2.061 | 52.35 | 1.781 | 45.24 | .252 | 6.40 |
| 51 3 row | 1.661 | 42.19 | 1.381 | 35.08 | .310 | 7.87 |
| 100 | 2.312 | 58.72 | 2.005 | 50.93 | .330 | 8.38 |

Product Selection Guide

Well-Master²⁶⁰®



GHTM Well-Master™ High Temperature Micro-D Oil, gas and geothermal wells can expose electronic equipment to temperatures in excess of 200°, exceeding the recommended operating temperature of standard Micro-D Connectors. For these demanding environments Glenair has developed the Well-Master™ to provide continuous operation in temperatures of 260° or more. With key features such as rugged Passivated Stainless steel shells and hardware, high temperature liquid crystal polymer (LCP) insulators allow these connectors to survive the most demanding high-temperature environments.

GHTM
Insulated Wire
Pigtails
Page J-3



High Temperature Micro-D with insulated Wire

GHTM PCB
Header
Page J-6



High Temperature Back-to-Back Micro-D



GHTM Well-Master™ 260 High Temperature Micro-D



+260°C PCB Header

+260°C Cable Connector

Glenair Well-Master™ 260 Micro-D Withstands Extreme High Temperature

Standard Micro-D connectors are rated for +125°C. Glenair's MWDM Micro-D can withstand +150°C continuous operating temperature and can be upgraded to +200°C if assembled with special high temperature epoxies. But oil, gas and geothermal wells can subject electronic instruments to temperatures as high as +260°C. The GHTM Series Micro-D meets the need for a high density, high performance connector capable of handling this temperature. The GHTM features contacts made from a special alloy that resists softening when exposed to temperatures up to +260°C (500° F). Rugged passivated stainless steel shells and hardware, high temperature liquid crystal polymer (LCP) insulators allow these connectors to survive the most demanding environments. Unique angled mounting ears allow the Well-Master™ 260° to fit in confined spaces.

J

GHTM High Temperature Contact Arrangements

| | | | |
|----|----|----|----|
| | | | |
| 9 | 15 | 21 | 25 |
| | | | |
| 31 | 37 | 51 | |

Mating face of pin connector. Socket connector contact numbers are reversed.

| Materials and Finishes | |
|------------------------|---|
| Contacts | Proprietary nickel alloy, gold plated |
| Insulators | Liquid crystal polymer (LCP) |
| Shell | Stainless steel, passivated |
| Mounting Hardware | Stainless Steel |
| Insulated Wire | Nickel-coated copper, PTFE insulation per M22759/87 (260°C) |

| Specifications | |
|---------------------------------|----------------------|
| Current Rating | 3 Amps |
| Contact Resistance | 8 milliohms maximum |
| Dielectric Withstanding Voltage | 600 Vac sea level |
| Insulation Resistance | 5000 megohms minimum |
| Operating Temperature | -55° C. to +260° C. |
| Shock | 50 g. |
| Vibration | 20 g. |

GHTM Well-Master™ 260 High Temperature Micro-D Insulated Wire Connectors



Micro-D
Well-Master™ 260

GHTM Pre-Wired Connectors with +260°C Mil Spec PTFE/Polyimide Wire



GHTM Well-Master™ 260 pre-wired Micro-D connectors withstand +260°C continuous operating temperature. These .050" pitch Micro-D connectors are terminated to #24 AWG insulated wire. Nickel-coated copper wire conforms to M22759/87, PTFE/polyimide insulation. Pin contacts are gold-plated high performance twistpin type and are recessed into insulator to prevent damage. Special nickel alloy contact material resists softening in high heat. Machined passivated stainless steel shell. Glass-filled high temperature LCP thermoplastic insulators. 100% hi-pot tested. Meets performance requirements of MIL-DTL-83513. Available with 9 to 51 contacts. 3 A., 600 Vac, -55°C to +260°C.

| How To Order GHTM Pre-Wired Assembly | | | | | | | | |
|--------------------------------------|--|-----|-----------------------|----|---|---|-----|---|
| Sample Part Number | GHTM | -31 | S | -4 | T | 1 | -18 | B |
| Series | GHTM Glenair High Temperature Micro | | | | | | | |
| Shell Size | 9, 15, 21, 25, 31, 37, 51 | | | | | | | |
| Contact Type | P - Pin/Plug | | S - Socket/Receptacle | | | | | |
| Wire Gage (AWG) | 4 - #24 | | | | | | | |
| Wire Type | T - PTFE/Polyimide Insulated Nickel Coated Copper | | | | | | | |
| Wire Color | 1 - White | | | | | | | |
| Wire Length (Inches) | 18 - Wire Length In Inches. "18" Specifies 18 Inches. | | | | | | | |
| Mounting Hardware | B - Std. Thru-Hole (Ø.089/.095) M - Hex Head Jackscrew S - Slot Head Jackscrew P - Integral Jackpost (See Table I) | | | | | | | |

| Table I: GHTM Mounting Hardware | | |
|---|---|---|
| B Std. Thru-Hole Mounting .096/.088 (2.43/2.23) Dia. (For dimensions see Table II) | M and S #2-56 Jackscrews Slot head (S), Hex Head (M) (For dimensions see Table II) | P Integral Jackpost #2-56 (For dimensions see Table III) |
| | | |
| Pin | Pin | Pin |
| | | |
| Socket | Socket | Socket |



GHTM Well-Master™ 260 High Temperature Micro-D Insulated Wire Connectors

Table II: QGHTM Pre-Wired Connector Dimensions for Thru-Hole and Jackscrew Versions



| Layout | A Max. | | B | | C Max. | | D | | E Max. | | F | | G Max. | | H Max. | |
|------------|--------|-------|---------------|---------------|--------|-------|------|-------|--------|------|---------------|---------------|--------|-------|--------|------|
| | In. | mm. | In. ± .003 | mm. ± 0.08 | In. | mm. | In. | mm. | In. | mm. | In. ± .003 | mm. ± 0.08 | In. | mm. | In. | mm. |
| 9P | .785 | 19.94 | .565 | 14.35 | .290 | 7.37 | .181 | 4.60 | .131 | 3.33 | .199 | 5.05 | .405 | 10.29 | .390 | 9.91 |
| 9S | .785 | 19.94 | .565 | 14.35 | .371 | 9.42 | .181 | 4.60 | .215 | 5.46 | .191 | 4.85 | .405 | 10.29 | .377 | 9.58 |
| 15P | .935 | 23.75 | .715 | 18.16 | .440 | 11.18 | .331 | 8.41 | .131 | 3.33 | .199 | 5.05 | .555 | 14.10 | .390 | 9.91 |
| 15S | .935 | 23.75 | .715 | 18.16 | .521 | 13.23 | .331 | 8.41 | .215 | 5.46 | .191 | 4.85 | .555 | 14.10 | .377 | 9.58 |
| 21P | 1.085 | 27.43 | .865 | 21.97 | .590 | 14.99 | .481 | 12.22 | .131 | 3.33 | .199 | 5.05 | .705 | 17.91 | .390 | 9.91 |
| 21S | 1.085 | 27.43 | .865 | 21.97 | .671 | 17.04 | .481 | 12.22 | .215 | 5.46 | .191 | 4.85 | .705 | 17.91 | .377 | 9.58 |
| 25P | 1.185 | 30.01 | .965 | 24.51 | .690 | 17.53 | .581 | 14.76 | .131 | 3.33 | .199 | 5.05 | .805 | 20.45 | .390 | 9.91 |
| 25S | 1.185 | 30.01 | .965 | 24.51 | .771 | 19.58 | .581 | 14.76 | .215 | 5.46 | .191 | 4.85 | .805 | 20.45 | .377 | 9.58 |
| 31P | 1.335 | 33.91 | 1.115 | 28.32 | .840 | 21.34 | .731 | 18.57 | .131 | 3.33 | .199 | 5.05 | .955 | 24.26 | .390 | 9.91 |
| 31S | 1.335 | 33.91 | 1.115 | 28.32 | .921 | 23.39 | .731 | 18.57 | .215 | 5.46 | .191 | 4.85 | .955 | 24.26 | .377 | 9.58 |
| 37P | 1.485 | 37.72 | 1.265 | 32.13 | .990 | 25.15 | .881 | 22.38 | .131 | 3.33 | .199 | 5.05 | 1.105 | 28.07 | .390 | 9.91 |
| 37S | 1.485 | 37.72 | 1.265 | 32.13 | 1.071 | 27.20 | .881 | 22.38 | .215 | 5.46 | .191 | 4.85 | 1.105 | 28.07 | .377 | 9.58 |
| 51P | 1.435 | 36.45 | 1.215 | 30.86 | .940 | 23.88 | .831 | 21.11 | .178 | 4.52 | .195 | 4.95 | 1.055 | 26.80 | .350 | 8.89 |
| 51S | 1.435 | 36.45 | 1.215 | 30.86 | .951 | 24.16 | .831 | 21.11 | .186 | 4.72 | .274 | 6.96 | 1.055 | 26.80 | .377 | 9.58 |

GHTM Well-Master™ 260 High Temperature Micro-D Insulated Wire Connectors



Micro-D
Well-Master™ 260

Table III: GHTM Pre-Wired Connector Dimensions Integral Jackpost Version



| Layout | A Max. | | B | | C Max. | | D | | E Max. | | F | | G Max. | | H Max. | | J | |
|--------|--------|-------|-----------|-----------|--------|-------|------|-------|--------|------|-----------|-----------|--------|-------|--------|------|-------|-------|
| | In. | mm. | In. ±.003 | mm. ±.008 | In. | mm. | In. | mm. | In. | mm. | In. ±.003 | mm. ±.008 | In. | mm. | In. | mm. | In. | mm. |
| 9P | .785 | 19.94 | .565 | 14.35 | .290 | 7.37 | .181 | 4.60 | .131 | 3.33 | .199 | 5.05 | .405 | 10.29 | .390 | 9.91 | .420 | 10.67 |
| 9S | .785 | 19.94 | .565 | 14.35 | .301 | 7.65 | .181 | 4.60 | .215 | 5.46 | .274 | 6.96 | .405 | 10.29 | .377 | 9.58 | N/A | N/A |
| 15P | .935 | 23.75 | .715 | 18.16 | .440 | 11.18 | .331 | 8.41 | .131 | 3.33 | .199 | 5.05 | .555 | 14.10 | .390 | 9.91 | .570 | 14.48 |
| 15S | .935 | 23.75 | .715 | 18.16 | .451 | 11.46 | .331 | 8.41 | .215 | 5.46 | .274 | 6.96 | .555 | 14.10 | .377 | 9.58 | N/A | N/A |
| 21P | 1.085 | 27.43 | .865 | 21.97 | .590 | 14.99 | .481 | 12.22 | .131 | 3.33 | .199 | 5.05 | .705 | 17.91 | .390 | 9.91 | .720 | 18.29 |
| 21S | 1.085 | 27.43 | .865 | 21.97 | .601 | 15.27 | .481 | 12.22 | .215 | 5.46 | .274 | 6.96 | .705 | 17.91 | .377 | 9.58 | N/A | N/A |
| 25P | 1.185 | 30.01 | .965 | 24.51 | .690 | 17.53 | .581 | 14.76 | .131 | 3.33 | .199 | 5.05 | .805 | 20.45 | .390 | 9.91 | .820 | 20.83 |
| 25S | 1.185 | 30.01 | .965 | 24.51 | .701 | 17.81 | .581 | 14.76 | .215 | 5.46 | .274 | 6.96 | .805 | 20.45 | .377 | 9.58 | N/A | N/A |
| 31P | 1.335 | 33.91 | 1.115 | 28.32 | .840 | 21.34 | .731 | 18.57 | .131 | 3.33 | .199 | 5.05 | .955 | 24.26 | .390 | 9.91 | .970 | 24.64 |
| 31S | 1.335 | 33.91 | 1.115 | 28.32 | .851 | 21.62 | .731 | 18.57 | .215 | 5.46 | .274 | 6.96 | .955 | 24.26 | .377 | 9.58 | N/A | N/A |
| 37P | 1.485 | 37.72 | 1.265 | 32.13 | .990 | 25.15 | .881 | 22.38 | .131 | 3.33 | .199 | 5.05 | 1.11 | 28.07 | .390 | 9.91 | 1.120 | 28.45 |
| 37S | 1.485 | 37.72 | 1.265 | 32.13 | 1.001 | 25.43 | .881 | 22.38 | .215 | 5.46 | .274 | 6.96 | 1.11 | 28.07 | .377 | 9.58 | N/A | N/A |
| 51P | 1.435 | 36.4 | 1.215 | 30.9 | .940 | 23.88 | .831 | 21.11 | .178 | 4.52 | .195 | 4.95 | 1.06 | 26.92 | .350 | 8.89 | 1.07 | 27.18 |
| 51S | 1.435 | 36.4 | 1.215 | 30.9 | .951 | 24.16 | .831 | 21.11 | .186 | 4.72 | .274 | 6.96 | 1.06 | 26.92 | .377 | 9.58 | N/A | N/A |



GHTM Well-Master™ 260 High Temperature Micro-D Right Angle Printed Circuit Board Headers

GHTM Right Angle Printed Circuit Board Headers



GHTM Well-Master™ 260 right angle PCB Micro-D connectors withstand +260°C continuous operating temperature. These .050" pitch Micro-D connectors have .020 inch diameter (0.51mm) gold-plated PC terminals. Terminal spacing is .100 inch (2.54 by 1.91mm). Pin contacts are gold-plated high performance twistpin type and are recessed into insulator to prevent damage. Special nickel alloy contact material resists softening in high heat. Machined passivated stainless steel shell with integral jackpost. Glass-filled high temperature LCP thermoplastic insulators to withstand soldering heat. Meets performance requirements of MIL-DTL-83513. Available with 9 to 51 contacts. 3 A., 600 Vac, -55°C to +260°C.



PIN (PLUG) CONNECTOR



SOCKET (RECEPTACLE) CONNECTOR

J

GHTM Right Angle PCB Connector Ordering Information

| Layout | .080 Inch (2.03mm) PC Terminal Length | .110 Inch (3.18 mm) PC Terminal Length | .150 Inch (3.81 mm) PC Terminal Length | .172 Inch (4.37 mm) PC Terminal Length | .190 Inch (4.83 mm) PC Terminal Length | .205 Inch (5.21 mm) PC Terminal Length |
|--------|--|---|---|---|---|---|
| 9P | GHTM-9PRAP-.080 | GHTM-9PRAP-.110 | GHTM-9PRAP-.150 | GHTM-9PRAP-.172 | GHTM-9PRAP-.190 | GHTM-9PRAP-.205 |
| 9S | GHTM-9SRAP-.080 | GHTM-9SRAP-.110 | GHTM-9SRAP-.150 | GHTM-9SRAP-.172 | GHTM-9SRAP-.190 | GHTM-9SRAP-.205 |
| 15P | GHTM-15PRAP-.080 | GHTM-15PRAP-.110 | GHTM-15PRAP-.150 | GHTM-15PRAP-.172 | GHTM-15PRAP-.190 | GHTM-15PRAP-.205 |
| 15S | GHTM-15SRAP-.080 | GHTM-15SRAP-.110 | GHTM-15SRAP-.150 | GHTM-15SRAP-.172 | GHTM-15SRAP-.190 | GHTM-15SRAP-.205 |
| 21P | GHTM-21PRAP-.080 | GHTM-21PRAP-.110 | GHTM-21PRAP-.150 | GHTM-21PRAP-.172 | GHTM-21PRAP-.190 | GHTM-21PRAP-.205 |
| 21S | GHTM-21SRAP-.080 | GHTM-21SRAP-.110 | GHTM-21SRAP-.150 | GHTM-21PRAP-.172 | GHTM-21SRAP-.190 | GHTM-21SRAP-.205 |
| 25P | GHTM-25PRAP-.080 | GHTM-25PRAP-.110 | GHTM-25PRAP-.150 | GHTM-25PRAP-.172 | GHTM-25PRAP-.190 | GHTM-25PRAP-.205 |
| 25S | GHTM-25SRAP-.080 | GHTM-25SRAP-.110 | GHTM-25SRAP-.150 | GHTM-25SRAP-.172 | GHTM-25SRAP-.190 | GHTM-25SRAP-.205 |
| 31P | GHTM-31PRAP-.080 | GHTM-31PRAP-.110 | GHTM-31PRAP-.150 | GHTM-31PRAP-.172 | GHTM-31PRAP-.190 | GHTM-31PRAP-.205 |
| 31S | GHTM-31SRAP-.080 | GHTM-31SRAP-.110 | GHTM-31SRAP-.150 | GHTM-31SRAP-.172 | GHTM-31SRAP-.190 | GHTM-31SRAP-.205 |
| 37P | GHTM-37PRAP-.080 | GHTM-37PRAP-.110 | GHTM-37PRAP-.150 | GHTM-37PRAP-.172 | GHTM-37PRAP-.190 | GHTM-37PRAP-.205 |
| 37S | GHTM-37SRAP-.080 | GHTM-37SRAP-.110 | GHTM-37SRAP-.150 | GHTM-37SRAP-.172 | GHTM-37SRAP-.190 | GHTM-37SRAP-.205 |
| 51P | GHTM-51PRAP-.080 | GHTM-51PRAP-.110 | GHTM-51PRAP-.150 | GHTM-51PRAP-.172 | GHTM-51PRAP-.190 | GHTM-51PRAP-.205 |
| 51S | GHTM-51SRAP-.080 | GHTM-51SRAP-.110 | GHTM-51SRAP-.150 | GHTM-51SRAP-.172 | GHTM-51SRAP-.190 | GHTM-51SRAP-.205 |

GHTM Well-Master™ 260 High Temperature Micro-D Right Angle Printed Circuit Board Headers



Micro-D
Well-Master™ 260

Table I: GHTM Right Angle PCB Dimensions for Pin (Plug) Connector



| Layout | A Max. | | B | | C Max. | | D | | E Max. | | F Max. | | G | | H Max. | |
|--------|--------|-------|---------------|---------------|--------|-------|------|-------|--------|------|--------|-------|-------|-------|--------|------|
| | In. | mm. | In. ± .003 | mm. ± 0.08 | In. | mm. | In. | mm. | In. | mm. | In. | mm. | In. | mm. | In. | mm. |
| 9P | .785 | 19.94 | .565 | 14.35 | .290 | 7.37 | .181 | 4.60 | .134 | 3.40 | .648 | 16.46 | .420 | 10.67 | .215 | 5.46 |
| 15P | .935 | 23.75 | .715 | 18.16 | .440 | 11.18 | .331 | 8.41 | .134 | 3.40 | .648 | 16.46 | .570 | 14.48 | .215 | 5.46 |
| 21P | 1.085 | 27.43 | .865 | 21.97 | .590 | 14.99 | .481 | 12.22 | .134 | 3.40 | .648 | 16.46 | .720 | 18.29 | .215 | 5.46 |
| 25P | 1.185 | 30.01 | .965 | 24.51 | .690 | 17.53 | .581 | 14.76 | .134 | 3.40 | .648 | 16.46 | .820 | 20.83 | .215 | 5.46 |
| 31P | 1.335 | 33.91 | 1.115 | 28.32 | .840 | 21.34 | .731 | 18.57 | .134 | 3.40 | .648 | 16.46 | .970 | 24.64 | .215 | 5.46 |
| 37P | 1.485 | 37.72 | 1.265 | 32.13 | .990 | 25.15 | .881 | 22.38 | .134 | 3.40 | .648 | 16.46 | 1.120 | 28.45 | .215 | 5.46 |
| 51P | 1.435 | 36.45 | 1.215 | 30.86 | .940 | 23.88 | .831 | 21.11 | .178 | 4.52 | .798 | 20.27 | 1.07 | 27.18 | .258 | 6.55 |



Well-Master™ 260 High Temperature Micro-D Right Angle Printed Circuit Board Headers

Table II: GHTM Right Angle PCB Dimensions for Socket (Receptacle) Connector



| Layout | A Max. | | B | | C Max. | | D | | E Max. | | F Max. | | G | |
|------------|--------|-------|------------|------------|--------|-------|------|-------|--------|------|--------|-------|------|------|
| | In. | mm. | In. ± .003 | mm. ± 0.08 | In. | mm. | In. | mm. | In. | mm. | In. | mm. | In. | mm. |
| 9S | .785 | 19.94 | .565 | 14.35 | .301 | 7.65 | .181 | 4.60 | .142 | 3.61 | .629 | 15.98 | .215 | 5.46 |
| 15S | .935 | 23.75 | .715 | 18.16 | .451 | 11.46 | .331 | 8.41 | .142 | 3.61 | .629 | 15.98 | .215 | 5.46 |
| 21S | 1.085 | 27.43 | .865 | 21.97 | .601 | 15.27 | .481 | 12.22 | .142 | 3.61 | .629 | 15.98 | .215 | 5.46 |
| 25S | 1.185 | 30.01 | .965 | 24.51 | .701 | 17.81 | .581 | 14.76 | .142 | 3.61 | .629 | 15.98 | .215 | 5.46 |
| 31S | 1.335 | 33.91 | 1.115 | 28.32 | .851 | 21.62 | .731 | 18.57 | .142 | 3.61 | .629 | 15.98 | .215 | 5.46 |
| 37S | 1.485 | 37.72 | 1.265 | 32.13 | 1.001 | 25.43 | .881 | 22.38 | .142 | 3.61 | .629 | 15.98 | .215 | 5.46 |
| 51S | 1.435 | 36.45 | 1.215 | 30.86 | .951 | 24.16 | .831 | 21.11 | .186 | 4.72 | .779 | 19.79 | .258 | 6.55 |

GHTM Well-Master™ 260
High Temperature Micro-D
Right Angle Printed Circuit Board Headers



Micro-D
Well-Master™ 260

GHTM Right Angle PC Board Layouts: Pin (Plug) Connector

Patterns shown are for component mounting side of PCB. Terminals are .022 (0.56) max. diameter, mounting holes are .093 (2.36) diameter. Segmented lines represent connector body envelope and integral standoff locations.



9 PIN



15 PIN



21 PIN



25 PIN





**GHTM Well-Master™ 260
High Temperature Micro-D
Right Angle Printed Circuit Board Headers**

GHTM Right Angle PC Board Layouts: Pin (Plug) Connector

Patterns shown are for component mounting side of PCB. Terminals are .022 (0.56) max. diameter, mounting holes are .093 (2.36) diameter. Segmented lines represent connector body envelope and integral standoff locations.



31 PIN



37 PIN



51 PIN

GHTM Well-Master™ 260
High Temperature Micro-D
Right Angle Printed Circuit Board Headers



Micro-D
Well-Master™ 260

GHTM Right Angle PC Board Layouts: Socket (Receptacle) Connector

Patterns shown are for component mounting side of PCB. Terminals are .022 (0.56) max. diameter, mounting holes are .093 (2.36) diameter. Segmented lines represent connector body envelope and integral standoff locations.



9 SOCKET



15 SOCKET



21 SOCKET



25 SOCKET





GHTM Well-Master™ 260 High Temperature Micro-D Right Angle Printed Circuit Board Headers

GHTM Right Angle PC Board Layouts: Socket (Receptacle) Connector

Patterns shown are for component mounting side of PCB. Terminals are .022 (0.56) max. diameter, mounting holes are .093 (2.36) diameter. Segmented lines represent connector body envelope and integral standoff locations.



31 SOCKET



37 SOCKET



51 SOCKET

SPECIAL
APPLICATIONS

GLENAIR MOD-CODES

Increase connector performance



Glenair Mod-Codes offer a variety of customizations to commercial connectors to meet your specific application requirements such as space grade outgassing. Manufacturers of satellite communications systems, geophysical exploration devices, medical diagnostics and industrial equipment face many of the same packaging requirements for reduced size, weight and shape as do their military counterparts. The ability to design-in a wide range of custom modifications which fit the unique packaging requirements of these specialized applications is a distinct advantage of the Glenair Micro-D.



Glenair®

Glenair, Inc.

1211 Air Way
Glendale, CA
91201-2497

818-247-6000
sales@glenair.com
www.glenair.com

Micro-D Mod Code List

Mod Code 474
Page K-2



Mod 474 Keying Option

Specially modified shells feature keys and keyways for up to five keying positions. Compatible with standard hardware and backshells.

Mod Code 497
Page K-4



Mod 497 Ground Spring

Improve EMI shielding with plug connector ground springs. These gold-plated springs offer lower shell-to-shell resistance and are compatible with standard mating receptacles.

Mod Code 497
Page K-5



Mod 497 Ground Spring Installation Procedure

Complete and easy to follow step-by-step installation instructions for Micro-D Ball Ground Spring. Installed in four simple steps, this gold-plated stainless steel ground spring offers substantial improvement in EMI protection.

Mod Code 428
Page K-6



Mod 428 for 200° C. Continuous Temperature

Standard Micro-D connectors are rated for 150° C. maximum continuous temperature. Mod 428 changes the potting compound to provide a 200° C. rating.

Mod Code 429
Page K-7

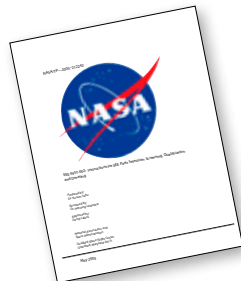

Mod 429 Space Grade Micro-D

Save time and cost with the Mod 429 solution. Specify special NASA requirements without the expense of having to create special procurement documentation. This section also contains valuable information on Micro-D's for space applications.



Micro-D Mod Code 474 Keying Options



Plug Connector With Mod 474 Keying Option

Prevent Mis-Mating with Mod Code 474 Keying Option

Keyed Micro-D connectors for "fail-safe" circuits feature specially modified shells to prevent mis-mating. The plug shell has a raised key, and the receptacle shell has a keyway.

The nine pin connector accommodates three key positions. All other sizes have five positions available. The letter code following Mod Code 474 specifies the key position. "474A" plugs mate to "474A" receptacles.

Keyed plugs will not mate to unkeyed receptacles, but keyed receptacles will plug into standard unkeyed plugs.

| How To Order Micro-D Connectors With Mod 474 | |
|--|---|
| <p>Step 1: Find a Standard Micro-D Part Number Mod 474 keying is available on all standard metal shell Micro-D connectors, including solder cup, pre-wired and printed circuit board versions. This feature is not available on plastic Micro-D or M83513 connectors.</p> | <p>Example: MWDM2L-51PCBRP-.110</p> |
| <p>Step 2: Pick a Keying Position A letter code identifies the key position. The table on the following page shows the keying options for each shell size. Mod Code 474A mates to 474A receptacles, and so on.</p> | <p>Example: 474B</p> |
| <p>Step 3: Add the Mod Code to the Part Number A letter code identifies the key position. The table on the following page shows the keying options for each shell size. Mod 474A plugs mate to 474A receptacles, and so on.</p> | <p>Example: MWDM2L-51PCBRP-.110-474B</p> |

K

| Micro-D Key Positions: Modification Code 474 | | | | |
|---|---|---|--|--|
| <p>Plug</p> <p>Fig. 1</p> | <p>Plug</p> <p>Fig. 2</p> | <p>Plug</p> <p>Fig. 3</p> | <p>Plug</p> <p>Fig. 4</p> | <p>Plug</p> <p>Fig. 5</p> |
| <p>Receptacle</p> <p>Fig. 6</p> | <p>Receptacle</p> <p>Fig. 7</p> | <p>Receptacle</p> <p>Fig. 8</p> | <p>Receptacle</p> <p>Fig. 9</p> | <p>Receptacle</p> <p>Fig. 10</p> |
| <p>Figure 1 plug connector mates to Figure 6 receptacle, figure 2 mates to figure 7, and so on. Figure 11 mates to figure 12.</p> | | <p>Plug</p> <p>Fig. 11</p> | <p>Receptacle</p> <p>Fig. 12</p> | <p>Mating face of connector shown.</p> |

Micro-D Mod Code 474 Keying Options and Rear Panel Mount Panel Cutouts



Key Position Offsets

| Layout | Key Position A | | | Key Position B | | | Key Position C | | | Key Position D | | | Key Position E | | |
|--------|----------------|--------|-------|----------------|--------|------|----------------|--------|-------|----------------|--------|-------|----------------|--------|-------|
| | Figure | Offset | | Figure | Offset | | Figure | Offset | | Figure | Offset | | Figure | Offset | |
| | | In. | mm. | | In. | mm. | | In. | mm. | | In. | mm. | | In. | mm. |
| 9P | 1 | .025 | 0.64 | 3 | .025 | 0.64 | 11 | .000 | 0.00 | NA | — | — | NA | — | — |
| 9S | 6 | .025 | 0.64 | 8 | .025 | 0.64 | 12 | .000 | 0.00 | NA | — | — | NA | — | — |
| 15P | 1 | .090 | 2.29 | 2 | .000 | 0.00 | 3 | .090 | 2.29 | 4 | .050 | 1.25 | 5 | .050 | 1.25 |
| 15S | 6 | .090 | 2.29 | 7 | .000 | 0.00 | 8 | .090 | 2.29 | 9 | .050 | 1.27 | 10 | .050 | 1.27 |
| 21P | 1 | .130 | 3.30 | 2 | .000 | 0.00 | 3 | .130 | 3.30 | 4 | .100 | 2.54 | 5 | .100 | 2.54 |
| 21S | 6 | .130 | 3.30 | 7 | .000 | 0.00 | 8 | .130 | 3.30 | 9 | .100 | 2.54 | 10 | .100 | 2.54 |
| 25P | 1 | .180 | 4.57 | 2 | .000 | 0.00 | 3 | .180 | 4.57 | 4 | .125 | 3.18 | 5 | .125 | 3.18 |
| 25S | 6 | .180 | 4.57 | 7 | .000 | 0.00 | 8 | .180 | 4.57 | 9 | .125 | 3.18 | 10 | .125 | 3.18 |
| 31P | 1 | .200 | 5.08 | 2 | .000 | 0.00 | 3 | .200 | 5.08 | 4 | .150 | 3.81 | 5 | .150 | 3.81 |
| 31S | 6 | .200 | 5.08 | 7 | .000 | 0.00 | 8 | .200 | 5.08 | 9 | .150 | 3.81 | 10 | .150 | 3.81 |
| 37P | 1 | .300 | 7.62 | 2 | .000 | 0.00 | 3 | .300 | 7.62 | 4 | .250 | 6.35 | 5 | .250 | 6.35 |
| 37S | 6 | .300 | 7.62 | 7 | .000 | 0.00 | 8 | .300 | 7.62 | 9 | .250 | 6.35 | 10 | .250 | 6.35 |
| 51P | 1 | .225 | 5.72 | 2 | .000 | 0.00 | 3 | .225 | 5.72 | 4 | .175 | 4.45 | 5 | .175 | 4.45 |
| 51S | 6 | .225 | 5.72 | 7 | .000 | 0.00 | 8 | .225 | 5.72 | 9 | .175 | 4.45 | 10 | .175 | 4.45 |
| 51-2P | 1 | .400 | 10.16 | 2 | .000 | 0.00 | 3 | .400 | 10.16 | 4 | .350 | 8.89 | 5 | .350 | 8.89 |
| 51-2S | 6 | .400 | 10.16 | 7 | .000 | 0.00 | 8 | .400 | 10.16 | 9 | .350 | 8.89 | 10 | .350 | 8.89 |
| 67P | 1 | .600 | 15.24 | 2 | .000 | 0.00 | 3 | .600 | 15.24 | 4 | .500 | 12.70 | 5 | .500 | 12.70 |
| 67S | 6 | .600 | 15.24 | 7 | .000 | 0.00 | 8 | .600 | 15.24 | 9 | .500 | 12.70 | 10 | .500 | 12.70 |
| 69P | 1 | .225 | 5.72 | 2 | .000 | 0.00 | 3 | .225 | 5.72 | 4 | .175 | 4.45 | 5 | .175 | 4.45 |
| 69S | 6 | .225 | 5.72 | 7 | .000 | 0.00 | 8 | .225 | 5.72 | 9 | .175 | 4.45 | 10 | .175 | 4.45 |
| 75P | 1 | 2.75 | 6.99 | 2 | .000 | 0.00 | 3 | .275 | 6.99 | 4 | .225 | 5.72 | 5 | .225 | 5.72 |
| 75S | 6 | .275 | 6.99 | 2 | .000 | 0.00 | 8 | .275 | 6.99 | 9 | .225 | 5.72 | 10 | .225 | 5.72 |
| 100P | 1 | .500 | 12.70 | 1 | .250 | 6.35 | 2 | .000 | 0.00 | 3 | .250 | 6.35 | 3 | .500 | 12.70 |
| 100S | 6 | .500 | 12.70 | 6 | .250 | 6.35 | 7 | .000 | 0.00 | 8 | .250 | 6.35 | 8 | .500 | 12.70 |
| 130P | 1 | .500 | 12.70 | 1 | .250 | 6.35 | 2 | .000 | 0.00 | 3 | .250 | 6.35 | 3 | .500 | 12.70 |
| 130S | 6 | .500 | 12.70 | 6 | .250 | 6.35 | 7 | .000 | 0.00 | 8 | .250 | 6.35 | 8 | .500 | 12.70 |

K

Mod Code 474 Rear Panel Mount Panel Cutouts



| Layout | A | | B | | C | | ØD | |
|--------|-------------------------|--------|-------------------------|------|----------------------------------|-------|--------------------------|------|
| | +0.004 (0.10) -0.000 | 10.36 | +0.004 (0.10) -0.000 | 7.65 | +0.003 (0.076) -0.003 (0.076) | 14.35 | +0.002 (0.051) -0.000 | 3.20 |
| 9 | 0.408 | 10.36 | 0.301 | 7.65 | 0.565 | 14.35 | 0.126 | 3.20 |
| 15 | 0.558 | 14.17 | 0.301 | 7.65 | 0.715 | 18.16 | 0.126 | 3.20 |
| 21 | 0.708 | 17.98 | 0.301 | 7.65 | 0.865 | 21.97 | 0.126 | 3.20 |
| 25 | 0.808 | 20.52 | 0.301 | 7.65 | 0.965 | 24.51 | 0.126 | 3.20 |
| 31 | 0.958 | 24.33 | 0.301 | 7.65 | 1.115 | 28.32 | 0.126 | 3.20 |
| 37 | 1.108 | 28.14 | 0.301 | 7.65 | 1.265 | 32.13 | 0.126 | 3.20 |
| 51 | 1.058 | 26.87 | 0.343 | 8.71 | 1.215 | 30.86 | 0.126 | 3.20 |
| 51-2 | 1.458 | 37.03 | 0.301 | 7.65 | 1.615 | 41.02 | 0.126 | 3.20 |
| 67 | 4.858 | 123.39 | 0.301 | 7.65 | 2.015 | 51.18 | 0.126 | 3.20 |
| 69 | 1.358 | 34.49 | 0.343 | 8.71 | 1.515 | 38.48 | 0.126 | 3.20 |
| 75 | 1.458 | 37.03 | 0.343 | 8.71 | 1.705 | 43.31 | 0.148 | 3.76 |
| 100 | 1.508 | 38.30 | 0.386 | 9.80 | 1.8 | 45.72 | 0.148 | 3.76 |
| 130 | 1.808 | 45.92 | 0.386 | 9.80 | 2.150 | 54.61 | 0.148 | 3.76 |



Micro-D Mod Code 497 EMI Ground Spring



Improve EMI Performance with Mod Code 497 Ground Springs

Today's military and aerospace electronics systems require improved EMI protection. Micro-D connectors are widely used in EMI applications; however, the shell-to-shell resistance of a mated pair can vary, resulting in inconsistent levels of shielding effectiveness. Ground springs assure consistent shell-to-shell resistance for improved EMI protection.

Ground Spring and EMI Shielding Effectiveness – A gold-plated stainless steel ground spring on the pin connector mating face offers substantial improvement in EMI protection. The graphs compare identical connectors tested with and without ground springs.



EMI Performance with Ground Spring



EMI Performance without Ground Spring



K

How To Order Micro-D Connectors With Mod 497 Springs

Step 1: Find a Standard Micro-D Part Number
Ground springs are available on all standard Micro-D plug connectors with solder cups, insulated wire, or printed circuit board. Ground spring usage is limited to pin connectors with electroless-nickel plated shells, or gold plated shells.

Example: MWDM2L-100P-6K7-18B
1. Plugs only (pin connectors)
2. Nickel and gold plated aluminum shells only

Step 2: Add the Mod Code to the Part Number

Example: MWDM2L-100P-6K7-18B-497

Micro-D Mod Code 497 EMI Ground Spring Installation Procedure



Step 1

Locate weld site on spring, indicated by a deformation in ring and a doubling of coils.

Note: When fitting spring to connector ensure that weld sits on the flat faces of the Micro-D™ connector as illustrated in Step 2.



Step 2

Place spring into one end of groove on connector plug and stretch spring to sit in channel. Ensure that weld sits on flat face of plug. Complete fitting spring around channel while maintaining position of weld on flat faces of plug.

Weld position should be located on top or bottom flat face



Step 3

Ensure that the spring is properly seated in the channel by using a plastic mechanical pencil or similar item to rotate/manipulate the spring into position.

Note: Perform this manipulation carefully and incrementally. Do not simply slide the mechanical pencil/tool across the spring as this can unevenly distribute more of the spring into one area of the slot, resulting in deformation of spring material and lead to binding/crashing when mating connectors.



Profile View

Incorrectly seated spring (pre-manipulation)



Correctly seated spring (post-manipulation)

Step 4

Check for proper fitting and for binding points in mating process. Three mating cycles are recommended to ensure a proper fit.

Note: Weld on spring may appear discolored, this is normal.



K



Micro-D Mod Code 428 for +200° C. Operating Temperature



**Potting a Micro-D with
Epoxy-Filled Syringe**

Upgrade to 200° Celcius with Mod Code 428 High Temperature Epoxy

The search for oil and gas has led to deeper reservoirs where extreme temperatures and pressures test the limits of electronics design. Oil well logging instruments must be able to withstand temperatures beyond the limits of standard connectors.

Micro-D connectors are made from temperature-resistant materials. The Liquid Crystal Polymer (LCP) glass-filled thermoplastic insulators easily withstand 400° F. The Fluorosilicone seals, TwistPin contacts and aluminum shells also are rated for continuous exposure to 400° F. The epoxy potting compound is the only component not rated for high temperature. Mod Code 428 upgrades the standard epoxy with a special 600° F. epoxy.



K

How To Order Micro-D Connectors With Mod 428 Hi Temp

Step 1: Find a Standard Micro-D part Number
Mod 428 is available on all standard metal shell Micro-D connectors, including solder cup, pre-wired and printed circuit board versions. Not available on plastic Micro-D or M83513 connectors.

Example: MWDM2L-37PSL
1. Metal shell only
2. Nickel-plated aluminum or stainless steel shells only.

Step 2: Add the Mod Code to the Part Number

Example: MWDM2L-37PSL-428

Application Notes

1. Shell Material & Finish: Electroless nickel plated aluminum is commonly used for high temperature connectors. Cadmium plated aluminum is not recommended for temperatures exceeding 175° C. because of discoloration and breakdown of the chromate seal applied to the cadmium. Stainless steel shells provide the best resistance to temperature and corrosive environments, but at the expense of weight and cost.

2. Potting Compound: 200° C Rated Epoxy



Detail of the Atmospheric Infrared Sounder Instrument (AIRS) with Glenair Micro-D Cables and Connectors

Photo courtesy JPL

Six things you should know about Micro-D connectors for space flight

1 Outgassing: What is outgassing, why is it important, and how does it affect connector selection? Is special processing required to meet outgassing requirements?

2 Screening: What is NASA screening and what level of screening is required?

3 Magnetic permeability: Are nonmagnetic connectors required?

4 Cryogenic exposure: Are Micro-D connectors suitable for -200° C. exposure?

5 Materials: Micro-D connectors offer a variety of materials and plating finishes. Which ones are recommended for space flight?

6 Wire Corrosion: M22759/33 irradiated Tefzel® wire is preferred for space applications. What about corrosion problems caused by this wire?

Save Time and Cost with Mod Code 429 Space Grade Micro-D's

Micro-D TwistPin connectors are a good choice for all types of orbital and deep space projects. Glenair's Mod Code 429 upgrades Micro-D's to NASA requirements without the need for a customer Statement of Work or Specification Control Drawing. This section explains Glenair Mod Code 429 ordering, and provides valuable information on outgassing and other space flight topics.

How To Order Space Grade Micro-D's

Step 1: Find a Standard Micro-D Part Number

Electroless nickel plated shells and Tefzel® wire are preferred for space flight. Cadmium plating is prohibited.

Step 2: Select a NASA Screening Level

The term "Screening Level" refers to the final inspection procedure.

Level 1 for mission-critical highest reliability

Level 2 for high reliability

Level 3 for standard reliability

Step 3: Outgassing Processing

A detailed explanation of outgassing is on the following pages. The interfacial seal on Micro-D receptacles does not meet NASA outgassing requirements unless it is baked or thermal vacuum outgassed. Some customers specify deleting the seal, some opt for a bakeout, and some customers specify thermal vacuum outgassing. Both the bakeout and thermal vacuum outgassing are extra cost.

Step 4: Select the Mod Code 429 that Matches the Desired Level of Screening and Outgassing

Use the following table to choose the right modification code. Add the mod code to the connector part number. Example: MWDM2L-37P-6J5-18L-**429C**

| NASA Screening Level | Special Screening Only | | Special Screening Plus Outgassing Processing | |
|------------------------------|-------------------------------|-----------------------------|--|---|
| | Interfacial Seal is Installed | Interfacial Seal is Deleted | 48 Hour Oven Bake 175° C. | Thermal Vacuum Outgassing 24 hrs. 125° C. |
| Level 1 Highest Reliability | Mod Code 429B | Mod Code 429F | Mod Code 429J | Mod Code 429C |
| Level 2 High Reliability | Mod Code 429 | Mod Code 429D | Mod Code 429K | Mod Code 429A |
| Level 3 Standard Reliability | (Use standard part number) | Mod Code 432 | Mod Code 186 | Mod Code 186M |





Micro-D Mod Code 429 Space Grade

1 Outgassing: What is outgassing and how does it affect connector selection? Is special processing required to meet outgassing requirements?

What is outgassing?

Plastic and rubber materials give off gaseous molecules. For example, the smell inside a new car is caused by polymer outgassing. Heat and vacuum increase the rate of diffusion. In a spacecraft the gases coming off polymers can contaminate optical surfaces and instruments. The result is degraded performance.

How is outgassing measured?

The space industry has adopted a standardized test procedure, ASTM E 595, to evaluate out-gassing properties of polymers. Small samples of material are heated to 125° C. at a vacuum of 5 X 10⁻⁵ torr for 24 hours. Then the sample is weighed to calculate the Total Mass Loss (TML). The TML cannot exceed 1.00% of the total initial mass. During the test, outgassed matter condenses on a cooled collector plate. The quantity of outgassed matter is calculated to determine the Collected Volatile Condensable Material (CVCM). The CVCM cannot exceed 0.10% of the original specimen mass.

MIL-DTL-83513 specifies that Micro-D connectors must meet outgassing requirements, but the interfacial seal exceeds the limit. How can this be?

The mil spec allows the TML and CVCM to be calculated based on the total mass of the nonmetallic components. The interfacial seal can exceed outgassing limits as long as the insulator and potting compound are well below maximum outgassing limits.

Is special outgassing necessary?

It depends on the customer. Some programs specify that all connectors be oven baked or thermal vacuum outgassed. For example, NASA GSFC programs typically require that the interfacial seals are deleted, along with level I screening and thermal vacuum outgassing processing.

Why pay extra for bakeout or thermal vacuum outgassing?

If the interfacial seal is not removed, NASA recommends a bakeout process. Table 1 demonstrates that a simple oven bake is sufficient to reduce volatile matter. The choice is up to the customer. Whatever level of processing, the Glenair mod 429 codes make ordering easy.

Outgassing At-a-Glance

- 1** Fluorosilicone Interfacial Seals exceed NASA outgassing limits.
- 2** NASA recommends removing the seal or performing a bakeout.
- 3** An inexpensive oven bakeout has better results than the more costly thermal vacuum outgassing.
- 4** Glenair Mod 429 codes provide an easy ordering solution, whatever the outgassing option.

K

| Component | Material | Brand Name | % Total Mass Loss (TML) | % Collected Volatile Condensable Material (CVCM) | Test Report |
|--|------------------------|---------------|-------------------------|--|---------------------|
| Thermoplastic Insulators and PCB Trays | Liquid Crystal Polymer | Vectra® C-130 | 0.03 | 0.00 | NASA Test #GSC17478 |
| Potting Compound | Epoxy | Hysol C9-4215 | 0.48 | 0.01 | Glenair Test |
| Interfacial Seal "as received" | Fluorosilicone | (none) | 0.99 | 0.13 | Glenair Test |
| Interfacial Seal with Oven Bakeout 8 hrs. 400° F. | Fluorosilicone | (none) | 0.03 | 0.01 | Glenair Test |
| Interfacial Seal with Thermal Vacuum Bakeout 24 hrs. 125° C. | Fluorosilicone | (none) | 0.08 | 0.02 | Glenair Test |
| Wire | Tefzel® | Tefzel® | 0.22 | 0.01 | NASA Test #GSC19998 |

2 screening: What level of screening is required?

What is NASA screening?

NASA specification EEE-INST-002 (see figure 2) provides instructions on selecting, screening and qualifying parts for use on NASA GSFC space flight projects. Table 2C in the NASA spec contains specific inspection instructions for MIL-DTL-83513 connectors. These screening requirements exceed the standard mil spec inspection levels.

What screening level is required?

NASA defines three levels of screening: level 1 for highest reliability, level 2 for high reliability, and level 3 for standard reliability. Level 3 equates to standard M83513 Group A and B lot acceptance testing, and levels 1 and 2 call for additional testing.

Why does Glenair perform extra screening tests?

Glenair has test procedures that go beyond the letter of the NASA spec. Meeting NASA requirements means not only inspecting per EEE-INST-002, but also building parts in accordance with NASA Technical Standard NASA-STD-8739.4 “Crimping, Interconnecting Cables, Harnesses, and Wiring”. Glenair fully meets these requirements and has obtained NASA certification. Our extra inspection steps reflect the fact that pre-wired connectors not only require best practices on the assembly floor, but also require thorough final electrical and mechanical testing.

What about qualification requirements?

Qualification is not required if the manufacturer has performed qualification testing per MIL-DTL-83513. Qualification by similarity is usually invoked for those Micro-D’s not specifically covered by the mil spec.

Due to the dynamic nature of this document, users are advised to check the <http://nepp.nasa.gov> website prior to every usage to obtain the latest document revision.

1.0 PURPOSE

The purpose of this document is to establish baseline criteria for selection, screening, qualification, and derating of EEE parts for use on NASA GSFC space flight projects. This document shall provide a mechanism to assure that appropriate parts are used in the fabrication of space hardware that will meet mission reliability objectives within budget constraints.

2.0 SCOPE

This document provides instructions for meeting three reliability levels of EEE parts requirements (see 6.0) based on mission needs. The terms “grade” and “level” are considered synonymous; i.e., a grade 1 part is consistent with reliability level 1. Levels of part reliability confidence decrease by reliability level, with level 1 being the highest reliability and level 3 the lowest. A reliability level 1 part has the highest level of manufacturing control and testing per military or DSCC specifications. Level 2 parts have reduced manufacturing control and testing. Level 3 Parts have no guaranteed reliability controls in the manufacturing process and no standardized testing requirements. The reliability of level 3 parts can vary significantly with each manufacturer, part type and LDC due to unreported and frequent changes in design, construction and materials.

GSFC projects and contractors shall incorporate this guideline into their Project EEE Parts Program.

3.0 DEFINITIONS

Screening. Screening tests are intended to remove nonconforming parts (parts with random defects that are likely to result in early failures, known as infant mortality) from an otherwise acceptable lot and thus increase confidence in the reliability of the parts selected for use.

Figure 1: Excerpt from NASA EEE-INST-002

| Inspection/ Test | NASA Level 1 | NASA Level 2 |
|--|--------------|--------------|
| Visual Inspection (3X magnification) | 100% | 100% |
| Mechanical | 2 pcs. | 2 pcs. |
| Voltage (DWV) | 100% | 2 pcs. |
| Insulation Resistance | 2 pcs. | 2 pcs. |
| Temperature Cycling | 2 pcs. | 2 pcs. |
| Low Level Contact Resistance | 2 pcs. | 2 pcs. |
| Mating Force | 2 pcs. | N/A |
| Solderability/Resistance to Soldering Heat | 2 pcs. | N/A |

Notes:
 1. NASA screening requirements from Table 2C of EEE-INST-002.
 2. Prior to NASA screening, parts are subjected to 100% DWV insulation resistance and continuity testing





Micro-D Mod Code 429 Space Grade

3 Magnetic permeability:
Are nonmagnetic connectors required?

Spacecraft designers generally avoid the use of ferromagnetic materials, which can become magnetized and can interfere with sensitive instruments. Micro-D connectors do not contain ferromagnetic materials, so magnetic permeability is not a concern. MIL-DTL-83513 requires a maximum permeability of 2 mu. Glenair hermetic Micro-D connectors are made from Kovar® alloy, a highly magnetic material. The stainless steel e-rings commonly used for Micro-D jackscrew attachment also exceed the 2 mu requirement.

4 Cryogenic exposure:
Are Micro-D connectors suitable for -200° C. ?

Micro-D connectors are rated to -55° C. Glenair has not performed testing below this temperature. EEE-INST-002 states "...experience has proven it is possible for (non-certified) connector types to be used successfully at cryogenic temperatures. It is recommended that connector samples should be subjected to five cycles of cryogenic temperature...(followed by examination for cracks and DWV)".

5 Materials:
Micro-D connectors offer a variety of materials and plating finishes. Which ones are recommended for space flight?

NASA recommends electroless nickel plated connector shells and crosslinked high strength ETFE (Tefzel®) wire. Cadmium plating is prohibited because it sublimates in a vacuum environment. Gold plating is acceptable but rarely used on Micro-D connector shells. NASA recommends electroless nickel plated connector shells and crosslinked high

strength ETFE (Tefzel®) wire. Cadmium plating is prohibited because it sublimates in a vacuum environment. Gold plating is acceptable but rarely used on Micro-D connector shells.

6 Wire Corrosion:
M22759/33 irradiated Tefzel® wire is preferred for space applications. What about corrosion problems caused by this wire?

Does M22759/33 wire have an outgassing problem?

Irradiated Tefzel® wire is known to cause tarnishing and corrosion of metal parts in close proximity, usually in sealed bags. Both MIL-DTL-83513 and NASA EEE-INST-002 contain cautionary notes regarding this problem. Wire manufacturers have not been able to eliminate this problem, which might be caused by the insulation extrusion process. This corrosion problem is referred to as "wire outgassing", which has led to confusion over the term outgassing. This problem has nothing to do with the ability of the wire to meet the TML and CVCM outgassing requirements of ASTM E595. M22759/33 irradiated Tefzel wire continues to be the wire of choice for spacecraft. This wire complies with outgassing requirements.

The corrosion problem

Micro-D connectors supplied as pre-wired assemblies should not be stored in sealed bags for extended periods. NASA recommends that parts be inspected for shell discoloration ("a dull "gun metal" appearance) and contact corrosion ("a flat black appearance"). Connectors with corroded contacts should be scrapped.

New Unit Pack Minimizes Corrosion

Glenair has adopted a new packaging standard to protect the connector from



Figure 2
Fluoropolymer-wrapped Connector and Perforated Bag

"Users are advised that some ETFE insulations are known to outgas trace amounts of corrosive fluorine over time. When this wire is used with nickel coated metal shell connectors and stored in sealed plastic or ESD bags, trapped fluorine can attack exposed metal shells and contacts."

Excerpt from Note 9, Table 2,
NASA EEE-INST-002

tarnishing or corrosion. Figure 2 shows Glenair's standard packaging for metal shell connectors supplied with M22759/33 wire. The connector is wrapped in Fluoropolymer tape and placed in a ventilated sulpher-free paper envelope.

Section L MIL-DTL-83513 Micro-D Connectors



Product Selection Guide

Glenair's Complete Micro-D Product Line includes all M83513 Micro-D connectors. Choose **Solder Cup, Pre-Wired or PCB** versions. Glenair M83513 connectors always use **TwistPin Contacts** for high performance, made in U.S.A.

Metal Shell
M83513/01 & 02

Page L-4

Plastic Shell
M83513/06 & 07

Page L-7



M83513/01, /02, /06, /07 **Solder Cup Metal or Plastic Shell**

These connectors feature gold-plated solder cup contacts for termination to #26 AWG or smaller wire.

Metal Shell
M83513/03 & 04

Page L-5

Plastic Shell
M83513/08 & 09

Page L-8



M83513/03, /04, /08, /09 **Pre-Wired Pigtails, Metal or Plastic Shell**

These crimped, epoxy-potted assemblies are available with insulated 19 strand #26 AWG wire or with #25 AWG uninsulated single strand wire. Insulated wire options include wire type, color code and length. Uninsulated wires are gold-plated or SnPb 60/40 solder dipped.

M83513/10 to 15
Right Angle Narrow PCB

Page L-10

M83513/16 to 21
Right Angle
Wide Style PCB

Page L-14



M83513/10 Thru 21 Right Angle .100" **Pitch Printed Circuit Board Connectors**

Select vertical or right angle mounting. PC tails are .020 inch (0.50 mm.) diameter on a .100 inch (2.54 mm.) offset grid. Jackposts and threaded inserts are available.

M83513/22 to 27
Vertical Mount PCB

Page L-18

M83513/28 Thru 33
Compact Vertical PCB

Page L-22



M83513/22 Thru 33 **Vertical Mount Printed Circuit Board**

These recent additions to the mil spec feature .075 inch by .100 inch PC terminal spacing. The plastic tray does not extend beyond the envelope of the metal connector shell.

M83513/05
Hardware Kits

Page L-26



M83513/05 **Jack screws and Jackposts**

These hardware kits contain stainless steel jack screws in two lengths. Choose slot head or hex head. Jack screws attach with e-rings. Jackposts also are stainless steel.



MIL-DTL-83513 At-A-Glance



What is the difference between a Glenair COTS Micro-D and a Glenair Mil Spec Micro-D? Which is less expensive?

All Glenair Micro-D's, whether mil spec or COTS, are built with the same components and meet identical requirements. A COTS Micro-D is not a lower cost version of a mil spec part. COTS versions offer more options than the mil spec versions.

Which is more readily available:
Mil Spec or COTS?

All M83513 aluminum shell connectors are in stock. All standard COTS versions are also stocked.

What is the difference between a Glenair Mil Spec connector and another brand?

MIL-DTL-83513 allows the use of low-cost stamped contacts; however, the Glenair Micro-D connector features the high performance TwistPin contact system. Glenair M83513 connectors are 100% Made in USA. Glenair's industry-leading Micro-D capacity and capabilities offer quick worldwide access to the full range of QPL items.

About The Mil Spec

The United States Department of Defense, Defense Logistics Agency, Defense Supply Center, Columbus, Ohio (DSCC, pronounced "Dessy"), maintains a vast library of military specifications covering all kinds of components used in defense equipment. These mil specs simplify system design and procurement, because mil spec parts do not require costly testing for suitability. Easy multiple sourcing is another key advantage of a mil spec part. MIL-DTL-83513 is a detail spec controlling dimensions, materials, performance and testing. This spec covers plastic and metal shell Micro-D connectors.

The QPL At-A-Glance

Manufacturers are required to perform a series of mechanical, electrical and environmental tests in order to be eligible for listing as an approved supplier. When DSCC approval is granted, the manufacturer is added to the Qualified Products List (QPL). Glenair is QPL approved for all M83513 variations.

The "Slash Sheets" At-A-Glance

In addition to the general specification, MIL-DTL-83513 contains a total of 33 Detail Specification Sheets, nicknamed "slash sheets" because a forward slash is used in the numbering system.

How to get a copy of the spec

DSCC specs are available for download. The documents include:

MIL-DTL-83513 Detail Specification (the general spec)
MIL-DTL-83513 Slash Sheets (33 individual specs)

These specs can be found at:

<http://www.dsccl.dla.mil/Programs/MilSpec/DocSearch.asp>

The QPL can be found at:

<http://www.dsccl.dla.mil/programs/qmlqpl/default.asp>

Glenair CAGE Codes

A **CAGE** (**C**ommercial **A**nd **G**overnment **E**ntity) Code is a five position code that identifies companies doing or wishing to do business with the Federal Government. Glenair uses two CAGE codes to identify M83513 products: **06324**, Glenair, Glendale, California
0CA77, Glenair Microway Division, Lincolnwood Illinois.

MIL-DTL-83513 Micro-D Connectors



Micro-D
MIL-DTL-83513

MIL-DTL-83513 contact arrangements (face view pin connector)



MIL-DTL-83513 Materials and Finishes (Specific to Glenair)

| | |
|--------------------------------|--|
| Connector Shell, Metal | Aluminum alloy 6061 in accordance with SAE-AMS-QQ-A-250/11 Plating Code C: Cadmium with yellow chromate conversion coating in accordance with SAE-AMS-QQ-P-416, Type II, Class 3 Plating Code N: Electroless nickel in accordance with SAE-AMS-26074, Class 3 Plating Code P: Stainless steel, 300 series, passivated in accordance with SAE-AMS-QQ-P-35 Plating Code A: Pure electrodeposited aluminum in accordance with MIL-DTL-83488, type II Plating Code K: Zinc nickel in accordance with ASTM B841 over a suitable underplate Plating Code T: Nickel fluorocarbon polymer, high phosphate nickel with fluorocarbon polymer additive over a suitable underplate |
| Connector Shell, Plastic | Liquid crystal polymer, 30% glass-filled or polyphenyl sulfide, 40% glass-filled, in accordance with MIL-M-24519 |
| Insulator | Liquid crystal polymer, 30% glass-filled or polyphenyl sulfide, 40% glass-filled, in accordance with MIL-M-24519 |
| Terminal Block, PCB | Liquid crystal polymer, 30% glass-filled or polyphenyl sulfide, 40% glass-filled, in accordance with MIL-M-24519 |
| Interfacial Seal | Fluorosilicone rubber in accordance with A-A-59588 |
| Pin Contact (TwistPin) | Beryllium copper, gold plated in accordance with ASTM B 488 Type II Class 1.27 (50 Microinches minimum) Code C, over nickel underplate in accordance with SAE-AMS-QQ-N-290, Class 2 (30 microinches minimum) |
| Socket Contact | Phos bronze in accordance with ASTM 139 gold plated in accordance with ASTM B 488 Type II Class 1.27 (50 Microinches minimum) Code C, over nickel underplate in accordance with SAE-AMS-QQ-N-290, Class 2 (30 microinches minimum) |
| Encapsulant (Potting) | Epoxy resin, hysol EE4215/HD3561 |
| Jackscrews, Jackposts | Stainless steel, passivated in accordance with SAE-AMS-2700 |
| Pigtail Wire, Insulated Hookup | MIL-W-22759/11: 19 strand silver-coated copper wire, extruded ptfе insulation, 600 volts rms, 200° C. MIL-W-22759/33: 19 strand high-strength silver-coated copper alloy wire, crosslinked modified ETFE insulation, 600 volts rms, 200° C. |
| Pigtail Wire, Uninsulated | Wire type 07 and 08: solid copper wire in accordance with A-A-59551, tin/lead plated wire type 05 and 06: solid copper wire in accordance with A-A-59551, gold-plated |

MIL-DTL-83513 Performance Specifications

| | |
|---------------------------------|--|
| Current Rating | 3 AMP |
| Dielectric Withstanding Voltage | 600 VAC Sea Level, 150 VAC 70,000 Feet |
| Insulation Resistance | 5000 Megohms Minimum |
| Contact Resistance | 8 Milliohms Maximum |
| Low Level Contact Resistance | 32 Milliohms Maximum |
| Magnetic Permeability | 2 μ Maximum |
| Operating Temperature | -55° C. to +125° C. |
| Shock | 50 g. |
| Vibration | 20 g. |
| Outgassing | Meets NASA Outgassing Requirements |
| Mating Force | (10 Ounces Maximum) X (# Of Contacts) |
| Salt Spray | 48 Hours Aluminum Shell With Cadmium Plating |
| Durability | 500 Mating Cycles Minimum |

© 2013 Glenair, Inc. High Performance Micro-D Connectors and Cables U.S. CAGE Code 06324 Printed in U.S.A.

GLENAIR, INC. • 1211 AIR WAY • GLENDALE, CA 91201-2497 • 818-247-6000 • FAX 818-500-9912

www.glenair.com

L-3

E-Mail: sales@glenair.com



MIL-DTL-83513/01 & /02 Micro-D Solder Cup Terminated, Metal Shell Connector



Metal Shell Solder Cup M83513 Connectors

feature gold-plated TwistPin non-removable contacts for solder termination to AWG #26 or smaller wire.

| M83513/01 & /02 Solder Cup Part Numbers | | | | | M83513/01 & /02 Solder Cup Part Numbers | | | | |
|---|------------|--|-------------------------------|----------------------------------|---|------------|--|-------------------------------|----------------------------------|
| Layout | Config. | Electroless Nickel Plated Aluminum Shell | Cadmium Plated Aluminum Shell | Passivated Stainless Steel Shell | Layout | Config. | Electroless Nickel Plated Aluminum Shell | Cadmium Plated Aluminum Shell | Passivated Stainless Steel Shell |
| 9P | Plug | M83513/01-AN | M83513/01-AC | M83513/01-AP | 31P | Plug | M83513/01-EN | M83513/01-EC | M83513/01-EP |
| 9S | Receptacle | M83513/02-AN | M83513/02-AC | M83513/02-AP | 31S | Receptacle | M83513/02-EN | M83513/02-EC | M83513/02-EP |
| 15P | Plug | M83513/01-BN | M83513/01-BC | M83513/01-BP | 37P | Plug | M83513/01-FN | M83513/01-FC | M83513/01-FP |
| 15S | Receptacle | M83513/02-BN | M83513/02-BC | M83513/02-BP | 37S | Receptacle | M83513/02-FN | M83513/02-FC | M83513/02-FP |
| 21P | Plug | M83513/01-CN | M83513/01-CC | M83513/01-CP | 51P | Plug | M83513/01-GN | M83513/01-GC | M83513/01-GP |
| 21S | Receptacle | M83513/02-CN | M83513/02-CC | M83513/02-CP | 51S | Receptacle | M83513/02-GN | M83513/02-GC | M83513/02-GP |
| 25P | Plug | M83513/01-DN | M83513/01-DC | M83513/01-DP | 100P | Plug | M83513/01-HN | M83513/01-HC | M83513/01-HP |
| 25S | Receptacle | M83513/02-DN | M83513/02-DC | M83513/02-DP | 100S | Receptacle | M83513/02-HN | M83513/02-HC | M83513/02-HP |

Dimensions



| Layout | A Max. | | B | | C Max. | | D Max. | | E Max. | | F | | G Max. | | H Max. | | J Max. | |
|--------|--------|-------|------------|------------|--------|-------|--------|------|--------|-------|------------|------------|--------|-------|--------|-------|--------|------|
| | In. | mm. | In. ± .003 | mm. ± 0.08 | In. | mm. | In. | mm. | In. | mm. | In. ± .003 | mm. ± 0.08 | In. | mm. | In. | mm. | In. | mm. |
| 9P | .785 | 19.94 | .565 | 14.35 | .333 | 8.46 | .184 | 4.67 | .310 | 7.87 | .183 | 4.65 | .416 | 10.57 | .400 | 10.16 | .270 | 6.86 |
| 9S | .785 | 19.94 | .565 | 14.35 | .400 | 10.16 | .250 | 6.35 | .310 | 7.87 | .195 | 4.95 | .429 | 10.90 | .400 | 10.16 | .270 | 6.86 |
| 15P | .935 | 23.75 | .715 | 18.16 | .483 | 12.27 | .184 | 4.67 | .310 | 7.87 | .183 | 4.65 | .416 | 10.57 | .550 | 13.97 | .270 | 6.86 |
| 15S | .935 | 23.75 | .715 | 18.16 | .551 | 14.00 | .250 | 6.35 | .310 | 7.87 | .195 | 4.95 | .429 | 10.90 | .550 | 13.97 | .270 | 6.86 |
| 21P | 1.085 | 27.56 | .865 | 21.97 | .633 | 16.08 | .184 | 4.67 | .310 | 7.87 | .183 | 4.65 | .416 | 10.57 | .700 | 17.78 | .270 | 6.86 |
| 21S | 1.085 | 27.56 | .865 | 21.97 | .701 | 17.81 | .250 | 6.35 | .310 | 7.87 | .195 | 4.95 | .429 | 10.90 | .700 | 17.78 | .270 | 6.86 |
| 25P | 1.185 | 30.01 | .965 | 24.51 | .733 | 18.62 | .184 | 4.67 | .310 | 7.87 | .183 | 4.65 | .416 | 10.57 | .800 | 20.32 | .270 | 6.86 |
| 25S | 1.185 | 30.01 | .965 | 24.51 | .801 | 20.35 | .250 | 6.35 | .310 | 7.87 | .195 | 4.95 | .429 | 10.90 | .800 | 20.32 | .270 | 6.86 |
| 31P | 1.335 | 33.91 | 1.115 | 28.32 | .883 | 22.43 | .184 | 4.67 | .310 | 7.87 | .183 | 4.65 | .416 | 10.57 | .950 | 24.13 | .270 | 6.86 |
| 31S | 1.335 | 33.91 | 1.115 | 28.32 | .951 | 24.16 | .250 | 6.35 | .310 | 7.87 | .195 | 4.95 | .429 | 10.90 | .950 | 24.13 | .270 | 6.86 |
| 37P | 1.485 | 37.72 | 1.265 | 32.13 | 1.033 | 26.24 | .184 | 4.67 | .310 | 7.87 | .183 | 4.65 | .416 | 10.57 | 1.100 | 27.94 | .270 | 6.86 |
| 37S | 1.485 | 37.72 | 1.265 | 32.13 | 1.101 | 27.96 | .250 | 6.35 | .310 | 7.87 | .195 | 4.95 | .429 | 10.90 | 1.100 | 27.94 | .270 | 6.86 |
| 51P | 1.435 | 36.45 | 1.215 | 30.86 | .983 | 24.97 | .228 | 5.79 | .351 | 8.92 | .183 | 4.65 | .416 | 10.57 | 1.050 | 26.67 | .310 | 7.87 |
| 51S | 1.435 | 36.45 | 1.215 | 30.86 | 1.051 | 26.70 | .296 | 7.52 | .351 | 8.92 | .195 | 4.95 | .429 | 10.90 | 1.050 | 26.67 | .310 | 7.87 |
| 100P | 2.170 | 55.12 | 1.800 | 45.72 | 1.383 | 35.13 | .270 | 6.86 | .394 | 10.01 | .183 | 4.65 | .416 | 10.57 | 1.442 | 36.63 | .360 | 9.14 |
| 100S | 2.170 | 55.12 | 1.800 | 45.72 | 1.451 | 36.86 | .333 | 8.46 | .394 | 10.01 | .195 | 4.95 | .429 | 10.90 | 1.442 | 36.63 | .360 | 9.14 |

MIL-DTL-83513/03 & /04 Micro-D Pre-Wired Crimp Terminated, Metal Shell Connector



Micro-D
MIL-DTL-83513



Micro-D Pre-Wired Pigtails

These connectors feature gold-plated TwistPin contacts and mil spec crimp termination. Specify aluminum shells for best availability. 100% tested and backpotted, ready for use.

Choose the Wire Type To Fit Your Application

For lightest weight and smallest diameter, select M22759/33 space grade insulated wire.

How To Order MIL-DTL- 83513 Pre-Wired Metal Shell Micro-D Connectors

| | | | | | |
|---------------------------|---|---|---|-----------|----------|
| Sample Part Number | M83513 | /04 | -B | 09 | N |
| Base Part Number | M83513 | | | | |
| Slash Number | /03 Pin Connector (Plug) /04 Socket Connector (Receptacle) | | | | |
| Shell Size | A, B, C, D, E, F, G, H (See Table I) Codes A - H specify the shell size. The number of contacts is shown below for reference. A - 9 B - 15 C - 21 D - 25 E - 31 F - 37 G - 51 H - 100 | | | | |
| Wire Type | M22759/11-26 Teflon®-Insulated Hookup Wire 01 - 18 Inches (457mm), White 02 - 36 Inches (914mm), White 03 - 18 Inches (457mm), 10 Color Repeating 04 - 36 Inches (914mm), 10 Color Repeating 13 - 72 Inches (1829mm), White 14 - 72 Inches (1829mm), 10 Color Repeating 25 AWG Single Strand Uninsulated Wire 05 - .500 Inch (12.7mm), Gold Plated 06 - 1.000 Inch (25.4mm), Gold Plated 07 - .500 Inch (12.7mm), Tin-Lead Plated(2) 08 - 1.000 Inch (25.4mm), Tin-Lead Plated(2) M22759/33-26 Irradiated Tefzel® Insulated Hookup Wire 09 - 18 Inches (457mm), White 10 - 36 Inches (914mm), White 11 - 18 Inches (457mm), 10 Color Repeating 12 - 36 Inches (914mm), 10 Color Repeating 15 - 72 Inches (1829mm), White 16 - 72 Inches (1829mm), 10 Color Repeating | | | | |
| Shell Finish | C - Cadmium A - Electrodeposited Aluminum | N - Electroless Nickel K - Zinc Nickel | P - Passivated SST T - Nickel Fluorocarbon Polymer | | |



Notes

1. Shell Material & Finish: Cadmium plating offers better corrosion resistance compared to nickel, but cad is not acceptable for space or RoHS applications. Electroless nickel plated aluminum is recommended for new design activity. Or, choose stainless steel shells for corrosive environments.
2. Tin-Plated Wire: Glenair M83513 connectors do not contain any components exceeding 97% tin.
3. M22759/33 Corrosion: The M83513 spec contains a cautionary note regarding M22759/33 wire. The wire insulation is known to cause corrosion to metal parts when stored in a sealed environment. This corrosion has been observed on M83513 connectors. Glenair has implemented a packaging procedure to minimize or eliminate this problem. Connectors are individually wrapped with teflon tape, and the unit pack is a perforated paper envelope. M22759/33 continues to be the preferred wire for space applications.



MIL-DTL-83513/03 & /04 Micro-D Pre-Wired Crimp Terminated, Metal Shell Connector

Table I: Dimensions



| Layout | A Max. | | B | | C Max. | | D Max. | | E Max. | | F | | G Max. | | H Max. | | J Max. | |
|--------|--------|-------|------------|------------|--------|-------|--------|------|--------|-------|------------|------------|--------|-------|--------|-------|--------|------|
| | In. | mm. | In. ± .003 | mm. ± 0.08 | In. | mm. | In. | mm. | In. | mm. | In. ± .003 | mm. ± 0.08 | In. | mm. | In. | mm. | In. | mm. |
| 9P | .785 | 19.94 | .565 | 14.35 | .333 | 8.46 | .184 | 4.67 | .310 | 7.87 | .183 | 4.65 | .416 | 10.57 | .400 | 10.16 | .270 | 6.86 |
| 9S | .785 | 19.94 | .565 | 14.35 | .400 | 10.16 | .250 | 6.35 | .310 | 7.87 | .195 | 4.95 | .429 | 10.90 | .400 | 10.16 | .270 | 6.86 |
| 15P | .935 | 23.75 | .715 | 18.16 | .483 | 12.27 | .184 | 4.67 | .310 | 7.87 | .183 | 4.65 | .416 | 10.57 | .550 | 13.97 | .270 | 6.86 |
| 15S | .935 | 23.75 | .715 | 18.16 | .551 | 14.00 | .250 | 6.35 | .310 | 7.87 | .195 | 4.95 | .429 | 10.90 | .550 | 13.97 | .270 | 6.86 |
| 21P | 1.085 | 27.56 | .865 | 21.97 | .633 | 16.08 | .184 | 4.67 | .310 | 7.87 | .183 | 4.65 | .416 | 10.57 | .700 | 17.78 | .270 | 6.86 |
| 21S | 1.085 | 27.56 | .865 | 21.97 | .701 | 17.81 | .250 | 6.35 | .310 | 7.87 | .195 | 4.95 | .429 | 10.90 | .700 | 17.78 | .270 | 6.86 |
| 25P | 1.185 | 30.01 | .965 | 24.51 | .733 | 18.62 | .184 | 4.67 | .310 | 7.87 | .183 | 4.65 | .416 | 10.57 | .800 | 20.32 | .270 | 6.86 |
| 25S | 1.185 | 30.01 | .965 | 24.51 | .801 | 20.35 | .250 | 6.35 | .310 | 7.87 | .195 | 4.95 | .429 | 10.90 | .800 | 20.32 | .270 | 6.86 |
| 31P | 1.335 | 33.91 | 1.115 | 28.32 | .883 | 22.43 | .184 | 4.67 | .310 | 7.87 | .183 | 4.65 | .416 | 10.57 | .950 | 24.13 | .270 | 6.86 |
| 31S | 1.335 | 33.91 | 1.115 | 28.32 | .951 | 24.16 | .250 | 6.35 | .310 | 7.87 | .195 | 4.95 | .429 | 10.90 | .950 | 24.13 | .270 | 6.86 |
| 37P | 1.485 | 37.72 | 1.265 | 32.13 | 1.033 | 26.24 | .184 | 4.67 | .310 | 7.87 | .183 | 4.65 | .416 | 10.57 | 1.100 | 27.94 | .270 | 6.86 |
| 37S | 1.485 | 37.72 | 1.265 | 32.13 | 1.101 | 27.96 | .250 | 6.35 | .310 | 7.87 | .195 | 4.95 | .429 | 10.90 | 1.100 | 27.94 | .270 | 6.86 |
| 51P | 1.435 | 36.45 | 1.215 | 30.86 | .983 | 24.97 | .228 | 5.79 | .351 | 8.92 | .183 | 4.65 | .416 | 10.57 | 1.050 | 26.67 | .310 | 7.87 |
| 51S | 1.435 | 36.45 | 1.215 | 30.86 | 1.051 | 26.70 | .296 | 7.52 | .351 | 8.92 | .195 | 4.95 | .429 | 10.90 | 1.050 | 26.67 | .310 | 7.87 |
| 100P | 2.170 | 55.12 | 1.800 | 45.72 | 1.383 | 35.13 | .270 | 6.86 | .394 | 10.01 | .183 | 4.65 | .416 | 10.57 | 1.442 | 36.63 | .360 | 9.14 |
| 100S | 2.170 | 55.12 | 1.800 | 45.72 | 1.451 | 36.86 | .333 | 8.46 | .394 | 10.01 | .195 | 4.95 | .429 | 10.90 | 1.442 | 36.63 | .360 | 9.14 |

MIL-DTL-83513/06 & /07 Micro-D Solder Cup Terminated, Plastic Shell Connector



Micro-D
MIL-DTL-83513



Plastic Shell Solder Cup M83513 Connectors

feature goldplated TwistPin non-removable contacts for solder termination to AWG #26 or smaller wire. These all-plastic connectors are more economical, lighter and smaller than metal shell versions.

| Part Numbers | | | | | | | | |
|--------------|------------|-------------|--------|------------|-------------|--------|------------|-------------|
| Layout | Config. | Part Number | Layout | Config. | Part Number | Layout | Config. | Part Number |
| 9P | Plug | M83513/06-A | 21P | Plug | M83513/06-C | 31P | Plug | M83513/06-E |
| 9S | Receptacle | M83513/07-A | 21S | Receptacle | M83513/07-C | 31S | Receptacle | M83513/07-E |
| 15P | Plug | M83513/06-B | 25P | Plug | M83513/06-D | 37P | Plug | M83513/06-F |
| 15S | Receptacle | M83513/07-B | 25S | Receptacle | M83513/07-D | 37S | Receptacle | M83513/07-F |
| | | | | | | 51P | Plug | M83513/06-G |
| | | | | | | 51S | Receptacle | M83513/07-G |

Table I: Dimensions



| Layout | A Max. | | B | | C Max. | | D Max. | | E Max. | | F Max. | | G Max. | | H Max. | | J Max. | |
|--------|--------|-------|-----------|-----------|--------|-------|--------|------|--------|------|--------|-------|--------|-------|--------|------|--------|------|
| | In. | mm. | In. ±.003 | mm. ±0.08 | In. | mm. | In. | mm. | In. | mm. | In. | mm. | In. | mm. | In. | mm. | In. | mm. |
| 9P | .788 | 20.02 | .565 | 14.35 | .292 | 7.42 | .218 | 5.54 | .202 | 5.13 | .395 | 10.03 | .408 | 10.36 | .173 | 4.39 | .134 | 3.40 |
| 9S | .788 | 20.02 | .565 | 14.35 | .380 | 9.65 | .218 | 5.54 | .185 | 4.70 | .375 | 9.53 | .408 | 10.36 | .173 | 4.39 | .218 | 5.54 |
| 15P | .938 | 23.83 | .715 | 18.16 | .442 | 11.23 | .218 | 5.54 | .202 | 5.13 | .395 | 10.03 | .558 | 14.17 | .173 | 4.39 | .134 | 3.40 |
| 15S | .938 | 23.83 | .715 | 18.16 | .530 | 13.46 | .218 | 5.54 | .185 | 4.70 | .375 | 9.53 | .558 | 14.17 | .173 | 4.39 | .218 | 5.54 |
| 21P | 1.088 | 27.64 | .865 | 21.97 | .592 | 15.04 | .218 | 5.54 | .202 | 5.13 | .395 | 10.03 | .708 | 17.98 | .173 | 4.39 | .134 | 3.40 |
| 21S | 1.080 | 27.64 | .865 | 21.97 | .680 | 17.27 | .218 | 5.54 | .185 | 4.70 | .375 | 9.53 | .708 | 17.98 | .173 | 4.39 | .218 | 5.54 |
| 25P | 1.188 | 30.18 | .965 | 24.51 | .692 | 17.58 | .218 | 5.54 | .202 | 5.13 | .395 | 10.03 | .808 | 20.52 | .173 | 4.39 | .134 | 3.40 |
| 25S | 1.185 | 30.18 | .965 | 24.51 | .780 | 19.81 | .218 | 5.54 | .185 | 4.70 | .375 | 9.53 | .808 | 20.52 | .173 | 4.39 | .218 | 5.54 |
| 31P | 1.338 | 33.99 | 1.115 | 28.32 | .842 | 21.39 | .218 | 5.54 | .202 | 5.13 | .395 | 10.03 | .958 | 24.33 | .173 | 4.39 | .134 | 3.40 |
| 31S | 1.338 | 33.99 | 1.115 | 28.32 | .930 | 23.62 | .218 | 5.54 | .185 | 4.70 | .375 | 9.53 | .958 | 24.33 | .173 | 4.39 | .218 | 5.54 |
| 37P | 1.488 | 37.80 | 1.265 | 32.13 | .992 | 25.20 | .218 | 5.54 | .202 | 5.13 | .395 | 10.03 | 1.108 | 28.14 | .173 | 4.39 | .134 | 3.40 |
| 37S | 1.488 | 37.80 | 1.265 | 32.13 | 1.080 | 27.43 | .218 | 5.54 | .185 | 4.70 | .375 | 9.53 | 1.108 | 28.14 | .173 | 4.39 | .218 | 5.54 |
| 51P | 1.438 | 36.53 | 1.215 | 30.86 | .942 | 23.93 | .260 | 6.60 | .202 | 5.13 | .395 | 10.03 | 1.058 | 26.87 | .220 | 5.59 | .177 | 4.50 |
| 51S | 1.438 | 36.53 | 1.215 | 30.86 | 1.030 | 26.16 | .260 | 6.60 | .185 | 4.70 | .375 | 9.53 | 1.058 | 26.87 | .220 | 5.59 | .260 | 6.60 |



MIL-DTL-83513/08 & /09 Micro-D Pre-Wired Crimp Terminated, Plastic Shell Connector



Micro-D Pre-Wired Pigtails

These connectors feature gold-plated TwistPin contacts and mil spec crimp termination. 100% tested and backpotted, ready for use.

Choose the Wire Type To Fit Your Application

For lightest weight and smallest diameter, select M22759/33 space grade insulated wire.

How To Order MIL-DTL-83513 Pre-Wired Plastic Shell Micro-D Connectors

| | | | | |
|---------------------------|---|-----------|-----------|-----------|
| Sample Part Number | M83513/ | 09 | -G | 12 |
| Base Part Number | M83513 | | | |
| Slash Number | /08 Pin Connector (Plug) /09 Socket Connector (Receptacle) | | | |
| Shell Size | A, B, C, D, E, F, G (See Table I) Codes A - H specify the shell size. The number of contacts is shown below for reference. A - 9 B - 15 C - 21 D - 25 E - 31 F - 37 G - 51 | | | |
| Wire Type | M22759/11-26 Teflon®-Insulated Hookup Wire 01 - 18 Inches (457mm), White 02 - 36 Inches (914mm), White 03 - 18 Inches (457mm), 10 Color Repeating 04 - 36 Inches (914mm), 10 Color Repeating 13 - 72 Inches (1829mm), White 14 - 72 Inches (1829mm), 10 Color Repeating M22759/33-26 Irradiated Tefzel® Insulated Hookup Wire 09 - 18 Inches (457mm), White 10 - 36 Inches (914mm), White 11 - 18 Inches (457mm), 10 Color Repeating 12 - 36 Inches (914mm), 10 Color Repeating 15 - 72 Inches (1829mm), White 16 - 72 Inches (1829mm), 10 Color Repeating 25 AWG Single Strand Uninsulated Wire 05 - .500 Inch (12.7mm), Gold Plated 06 - 1.000 Inch (25.4mm), Gold Plated 07 - .500 Inch (12.7mm), Tin-Lead Plated(2) 08 - 1.000 Inch (25.4mm), Tin-Lead Plated(2) | | | |

Application Notes

- Intermateability: M83513 plastic shell connectors are not intermateable with metal shell M83513 connectors.
- Tin-Plated Wire: Glenair M83513 connectors do not contain any components exceeding 97% tin.
- M22759/33 Corrosion: The M83513 spec contains a cautionary note regarding M22759/33 wire. The wire insulation is known to cause corrosion to metal parts when stored in a sealed environment. This corrosion has been observed on M83513 connectors. Glenair has implemented a packaging procedure to minimize or eliminate this problem. Connectors are individually wrapped with teflon tape, and the unit pack is a perforated paper envelope. M22759/33 continues to be the preferred wire for space applications.

MIL-DTL-83513/08 & /09 Micro-D Pre-Wired Crimp Terminated, Plastic Shell Connector



Micro-D
MIL-DTL-83513

Table I: Dimensions



LENGTH FOR INSULATED STRANDED WIRE



| Layout | A Max. | | B | | C Max. | | D Max. | | E Max. | | F Max. | | G Max. | | H Max. | | J Max. | |
|--------|--------|-------|---------------|---------------|--------|-------|--------|------|--------|------|--------|-------|--------|-------|--------|------|--------|------|
| | In. | mm. | In. ± .003 | mm. ± 0.08 | In. | mm. | In. | mm. | In. | mm. | In. | mm. | In. | mm. | In. | mm. | In. | mm. |
| 9P | .788 | 20.02 | .565 | 14.35 | .292 | 7.42 | .218 | 5.54 | .202 | 5.13 | .395 | 10.03 | .408 | 10.36 | .173 | 4.39 | .134 | 3.40 |
| 9S | .788 | 20.02 | .565 | 14.35 | .380 | 9.65 | .218 | 5.54 | .185 | 4.70 | .375 | 9.53 | .408 | 10.36 | .173 | 4.39 | .218 | 5.54 |
| 15P | .938 | 23.83 | .715 | 18.16 | .442 | 11.23 | .218 | 5.54 | .202 | 5.13 | .395 | 10.03 | .558 | 14.17 | .173 | 4.39 | .134 | 3.40 |
| 15S | .938 | 23.83 | .715 | 18.16 | .530 | 13.46 | .218 | 5.54 | .185 | 4.70 | .375 | 9.53 | .558 | 14.17 | .173 | 4.39 | .218 | 5.54 |
| 21P | 1.088 | 27.64 | .865 | 21.97 | .592 | 15.04 | .218 | 5.54 | .202 | 5.13 | .395 | 10.03 | .708 | 17.98 | .173 | 4.39 | .134 | 3.40 |
| 21S | 1.080 | 27.64 | .865 | 21.97 | .680 | 17.27 | .218 | 5.54 | .185 | 4.70 | .375 | 9.53 | .708 | 17.98 | .173 | 4.39 | .218 | 5.54 |
| 25P | 1.188 | 30.18 | .965 | 24.51 | .692 | 17.58 | .218 | 5.54 | .202 | 5.13 | .395 | 10.03 | .808 | 20.52 | .173 | 4.39 | .134 | 3.40 |
| 25S | 1.185 | 30.18 | .965 | 24.51 | .780 | 19.81 | .218 | 5.54 | .185 | 4.70 | .375 | 9.53 | .808 | 20.52 | .173 | 4.39 | .218 | 5.54 |
| 31P | 1.338 | 33.99 | 1.115 | 28.32 | .842 | 21.39 | .218 | 5.54 | .202 | 5.13 | .395 | 10.03 | .958 | 24.33 | .173 | 4.39 | .134 | 3.40 |
| 31S | 1.338 | 33.99 | 1.115 | 28.32 | .930 | 23.62 | .218 | 5.54 | .185 | 4.70 | .375 | 9.53 | .958 | 24.33 | .173 | 4.39 | .218 | 5.54 |
| 37P | 1.488 | 37.80 | 1.265 | 32.13 | .992 | 25.20 | .218 | 5.54 | .202 | 5.13 | .395 | 10.03 | 1.108 | 28.14 | .173 | 4.39 | .134 | 3.40 |
| 37S | 1.488 | 37.80 | 1.265 | 32.13 | 1.080 | 27.43 | .218 | 5.54 | .185 | 4.70 | .375 | 9.53 | 1.108 | 28.14 | .173 | 4.39 | .218 | 5.54 |
| 51P | 1.438 | 36.53 | 1.215 | 30.86 | .942 | 23.93 | .260 | 6.60 | .202 | 5.13 | .395 | 10.03 | 1.058 | 26.87 | .220 | 5.59 | .177 | 4.50 |
| 51S | 1.438 | 36.53 | 1.215 | 30.86 | 1.030 | 26.16 | .260 | 6.60 | .185 | 4.70 | .375 | 9.53 | 1.058 | 26.87 | .220 | 5.59 | .260 | 6.60 |





MIL-DTL-83513/10 Thru /15 Micro-D CBR Condensed Right Angle PCB Terminated



High Performance

These connectors feature gold-plated TwistPin contacts for best performance. PC tails are .020 inch diameter. Specify nickel-plated shells or cadmium plated shells for best availability.

Solder-Dipped

Terminals are coated with Sn60/Pb40 tin-lead solder for best solderability.

How To Order MIL-DTL-83513 Right Angle Micro-D Connectors

| Sample Part Number | M83513/ | 13-B | 02 | N | P |
|--------------------------|---|--|-------------------------------------|---|---|
| Base Part Number | M83513 | | | | |
| Slash Number-Shell Sizes | Plug (Pin Contacts) | | Receptacle (Socket Contacts) | | |
| | 10-A - 9 Contacts 10-B - 15 Contacts 10-C - 21 Contacts 10-D - 25 Contacts 10-E - 31 Contacts 10-F - 37 Contacts 11-G - 51 Contacts 12-H - 100 Contacts (See Table II) | 13-A - 9 Contacts 13-B - 15 Contacts 13-C - 21 Contacts 13-D - 25 Contacts 13-E - 31 Contacts 13-F - 37 Contacts 14-G - 51 Contacts 15-H - 100 Contacts | | | |
| PC Tail Length | 01 - .109 Inch (2.77 mm) PC Tail Length ± .015 (0.38) | 02 - .140 Inch (3.56 mm) | 03 - .172 Inch (4.37 mm) | | |
| Shell Finish | C - Cadmium N - Electroless Nickel P - Passivated SST | A - Electrodeposited Aluminum K - Zinc Nickel T - Nickel Fluorocarbon Polymer | | | |
| Hardware Options | N - No Jackpost P - Jackposts Installed Sizes 9-51 T - Threaded Insert in Board Mount Hole (No Jackposts) W - Threaded Insert in Board Mount Hole and jackposts Installed Shell Size 100 (H) U - #4-40 Threaded Insert Y - #4-40 Threaded Insert & Jackpost See "Hardware Options" below for Illustrations (See Table I) | | | | |

Table I: Hardware Options

| N | P | T or U | W or Y |
|-------------|-----------|-----------------|---------------------------|
| | | | |
| THRU HOLE | THRU HOLE | THREADED INSERT | THREADED INSERT |
| No Jackpost | Jackpost | Threaded Insert | Jackpost, Threaded Insert |

MIL-DTL-83513/10 Thru /15 Micro-D CBR Condensed Right Angle PCB Terminated



Micro-D
MIL-DTL-83513

Table II: Dimensions



THREAD SIZES
9-51 CONTACTS #2-56 UNC
100 CONTACTS #4-40 UNC

CONFIGURATION FOR 9-25 CONTACTS



PCB MOUNTING HOLES
9-51 CONTACTS .096 DIA. $\pm .003$ (2.44 \pm 0.08)
100 CONTACTS .125 DIA. $\pm .003$ (3.18 \pm 0.08)

CONFIGURATION FOR 31-100 CONTACTS



| Layout | A Max. | | B | | C Max. | | D Max. | | E Max. | | F | | G Max. | | H | | J | | K Max. | | L Max. | |
|--------|--------|-------|-------------------|-------------------|--------|-------|--------|------|--------|-------|-------------------|-------------------|--------|-------|-------------------|-------------------|-------------------|-------------------|--------|-------|--------|-------|
| | In. | mm. | In. $\pm .003$ | mm. ± 0.08 | In. | mm. | In. | mm. | In. | mm. | In. $\pm .003$ | mm. ± 0.08 | In. | mm. | In. $\pm .010$ | mm. ± 0.25 | In. $\pm .010$ | mm. ± 0.25 | In. | mm. | In. | mm. |
| 9P | .787 | 19.94 | .565 | 14.35 | .333 | 8.46 | .184 | 4.67 | .310 | 7.87 | .183 | 4.65 | .425 | 10.80 | .230 | 5.84 | .250 | 6.35 | -- | -- | -- | -- |
| 9S | .787 | 19.94 | .565 | 14.35 | .400 | 10.16 | .250 | 6.35 | .310 | 7.87 | .195 | 4.95 | .425 | 10.80 | .230 | 5.84 | .250 | 6.35 | -- | -- | -- | -- |
| 15P | .937 | 23.75 | .715 | 18.16 | .483 | 12.27 | .184 | 4.67 | .310 | 7.87 | .183 | 4.65 | .425 | 10.80 | .130 | 3.30 | .250 | 6.35 | -- | -- | -- | -- |
| 15S | .937 | 23.75 | .715 | 18.16 | .551 | 14.00 | .250 | 6.35 | .310 | 7.87 | .195 | 4.95 | .425 | 10.80 | .130 | 3.30 | .250 | 6.35 | -- | -- | -- | -- |
| 21P | 1.087 | 27.56 | .865 | 21.97 | .633 | 16.08 | .184 | 4.67 | .310 | 7.87 | .183 | 4.65 | .425 | 10.80 | .130 | 3.30 | .250 | 6.35 | -- | -- | -- | -- |
| 21S | 1.087 | 27.56 | .865 | 21.97 | .701 | 17.81 | .250 | 6.35 | .310 | 7.87 | .195 | 4.95 | .425 | 10.80 | .130 | 3.30 | .250 | 6.35 | -- | -- | -- | -- |
| 25P | 1.187 | 30.01 | .965 | 24.51 | .733 | 18.62 | .184 | 4.67 | .310 | 7.87 | .183 | 4.65 | .425 | 10.80 | .130 | 3.30 | .250 | 6.35 | -- | -- | -- | -- |
| 25S | 1.187 | 30.01 | .965 | 24.51 | .801 | 20.35 | .250 | 6.35 | .310 | 7.87 | .195 | 4.95 | .425 | 10.80 | .130 | 3.30 | .250 | 6.35 | -- | -- | -- | -- |
| 31P | 1.337 | 33.91 | 1.115 | 28.32 | .883 | 22.43 | .184 | 4.67 | .310 | 7.87 | .183 | 4.65 | .525 | 13.34 | .130 | 3.30 | .250 | 6.35 | .450 | 11.43 | 1.085 | 27.56 |
| 31S | 1.337 | 33.91 | 1.115 | 28.32 | .951 | 24.16 | .250 | 6.35 | .310 | 7.87 | .195 | 4.95 | .525 | 13.34 | .130 | 3.30 | .250 | 6.35 | .450 | 11.43 | 1.085 | 27.56 |
| 37P | 1.487 | 37.72 | 1.265 | 32.13 | 1.033 | 26.24 | .184 | 4.67 | .310 | 7.87 | .183 | 4.65 | .525 | 13.34 | .130 | 3.30 | .250 | 6.35 | .450 | 11.43 | 1.185 | 30.10 |
| 37S | 1.487 | 37.72 | 1.265 | 32.13 | 1.101 | 27.96 | .250 | 6.35 | .310 | 7.87 | .195 | 4.95 | .525 | 13.34 | .130 | 3.30 | .250 | 6.35 | .450 | 11.43 | 1.185 | 30.10 |
| 51P | 1.435 | 36.45 | 1.215 | 30.86 | .983 | 24.97 | .228 | 5.79 | .351 | 8.92 | .183 | 4.65 | .660 | 16.76 | .150 | 3.81 | .300 | 7.62 | .450 | 11.43 | 1.225 | 31.12 |
| 51S | 1.435 | 36.45 | 1.215 | 30.86 | 1.051 | 26.70 | .296 | 7.52 | .351 | 8.92 | .195 | 4.95 | .660 | 16.76 | .150 | 3.81 | .300 | 7.62 | .450 | 11.43 | 1.225 | 31.12 |
| 100P | 2.175 | 55.12 | 1.800 | 45.72 | 1.383 | 35.13 | .270 | 6.86 | .394 | 10.01 | .183 | 4.65 | 1.010 | 25.65 | .200 | 5.08 | .400 | 10.16 | .590 | 14.99 | 1.820 | 46.23 |
| 100S | 2.175 | 55.12 | 1.800 | 45.72 | 1.451 | 36.86 | .333 | 8.46 | .394 | 10.01 | .195 | 4.95 | 1.010 | 25.65 | .200 | 5.08 | .400 | 10.16 | .590 | 14.99 | 1.820 | 46.23 |





MIL-DTL-83513/10 Thru /15 Micro-D CBR Condensed Right Angle PCB Terminated

M83513/10 Thru /12 Connector PCB Layouts – Pin Connectors

Patterns shown are for connector mounting side of PC board. 9 Thru 51 Contacts .096 (2.44) Diameter Mounting Holes, 100 Pin .125 (3.18) Diameter



9 PIN M83513/10-A



15 PIN M83513/10-B



21 PIN M83513/10-C



25 PIN M83513/10-D



31 PIN M83513/10-E



37 PIN M83513/10-F



51 PIN M83513/11-G

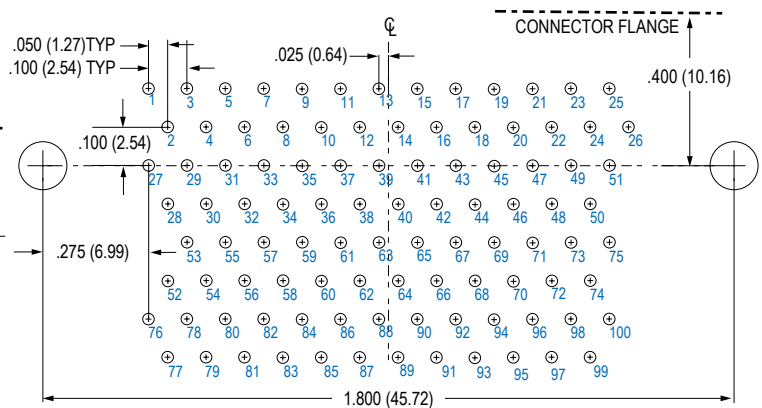

100 PIN M83513/12-H

M83513/13 THRU /15 connector PCB Layouts – Socket Connectors

Patterns shown are for connector mounting side of PC board. 9 Thru 51 Contacts .096 (2.44) Diameter Mounting Holes, 100 Pin .125 (3.18) Diameter



9 SOCKET M83513/13-A



15 SOCKET M83513/13-B

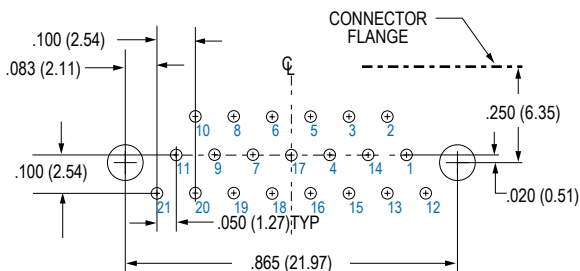

21 SOCKET M83513/13-C

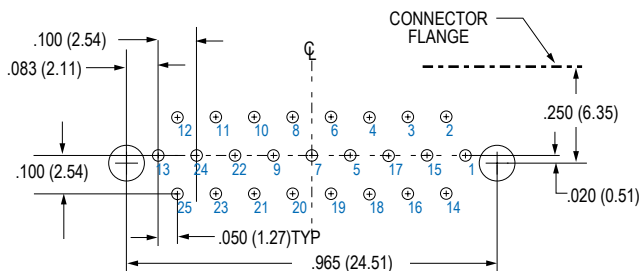

25 SOCKET M83513/13-D

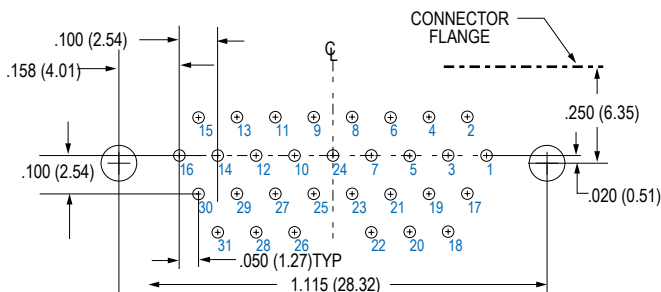

31 SOCKET M83513/13-E

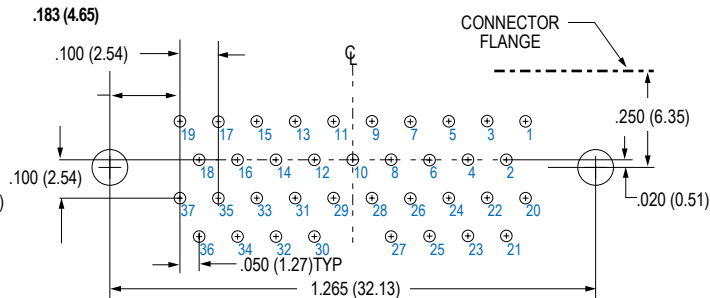

37 SOCKET M83513/13-F

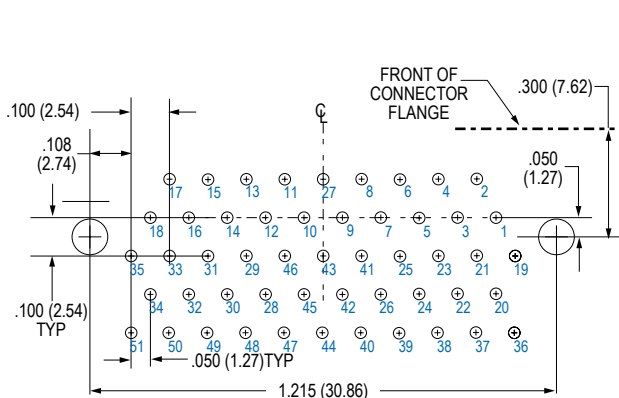

51 SOCKET M83513/14-G

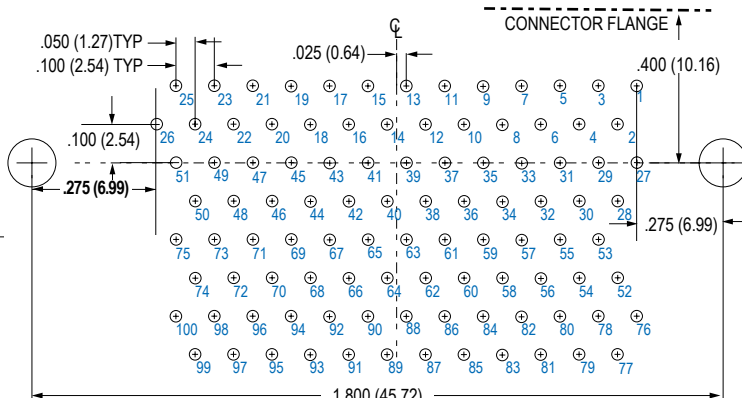

100 SOCKET M83513/15-H



MIL-DTL-83513/16 Thru /21 Micro-D BR Right Angle PCB Terminated Connector



High Performance

These connectors feature gold-plated TwistPin contacts for best performance. PC tails are .020 inch diameter. Specify nickel-plated shells or cadmium plated shells for best availability.

Solder-Dipped

Terminals are coated with Sn60/Pb40 tin-lead solder for best solderability.

How To Order MIL-DTL 83513 Right Angle PCB Micro-D Connectors

| Sample Part Number | | M83513/ | 19-F | 02 | N | P |
|---|--|--|--|----|---|---|
| Base Part Number | M83513 | | | | | |
| Slash Number-Shell Sizes | Plug (Pin Contacts) | Receptacle (Socket Contacts) | | | | |
| | 16-A - 9 Contacts 16-B - 15 Contacts 16-C - 21 Contacts 16-D - 25 Contacts 16-E - 31 Contacts 16-F - 37 Contacts 17-G - 51 Contacts 18-H - 100 Contacts | 19-A - 9 Contacts 19-B - 15 Contacts 19-C - 21 Contacts 19-D - 25 Contacts 19-E - 31 Contacts 19-F - 37 Contacts 20-G - 51 Contacts 21-H - 100 Contacts | | | | |
| PC Tail Length | 01 - .109 Inch (2.77 mm) | 02 - .140 Inch (3.56 mm) | 03 - .172 Inch (4.37 mm) | | | |
| Shell Finish | C - Cadmium | | A - Electrodeposited Aluminum | | | |
| | N - Electroless Nickel | | K - Zinc Nickel | | | |
| Hardware Options | P - Passivated SST | | T - Nickel Fluorocarbon Polymer | | | |
| | N - No Jackpost | | P - Jackposts Installed | | | |
| Sizes 9-51 | | | | | | |
| T - Threaded Insert in Board Mount Hole (No Jackposts) | | | | | | |
| W - Threaded Insert in Board Mount Hole and jackposts Installed | | | | | | |
| Shell Size 100 (H) | | | | | | |
| U - #4-40 Threaded Insert Y - #4-40 Threaded Insert & Jackpost (See Table I) | | | | | | |

Table I: Hardware Options

| N | P | T or U | W or Y |
|-------------|-----------|-----------------|---------------------------|
| | | | |
| THRU HOLE | THRU HOLE | THREADED INSERT | THREADED INSERT |
| No Jackpost | Jackpost | Threaded Insert | Jackpost, Threaded Insert |

MIL-DTL-83513/16 Thru /21 Micro-D BR Right Angle PCB Terminated Connector



Micro-D
MIL-DTL-83513

Table II: Dimensions

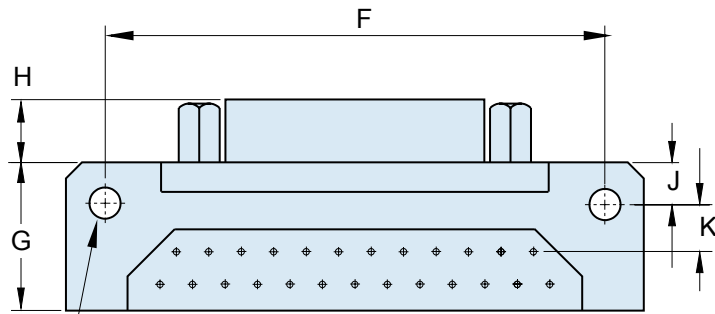

2 X PCB MTNG HOLES
9-51 CONTACTS $.096 \pm .005$ (2.43 ± 0.13)
100 CONTACTS $.125 \pm .005$ (23.18 ± 0.13)

THREAD SIZES
9-51 CONTACTS #2-56 UNC
100 CONTACTS #4-40 UNC

| Layout | A Max. | | B | | C Max. | | D Max. | | E Max. | | F | | G Max. | | H | | J | | K | |
|--------|--------|-------|--------------|--------------|--------|-------|--------|------|--------|-------|--------------|--------------|--------|-------|--------------|--------------|--------------|--------------|--------------|--------------|
| | In. | mm. | In. ±.005 | mm. ±0.10 | In. | mm. | In. | mm. | In. | mm. | In. ±.007 | mm. ±0.18 | In. | mm. | In. ±.003 | mm. ±0.08 | In. ±.015 | mm. ±0.38 | In. ±.010 | mm. ±0.25 |
| 9P | 1.390 | 35.31 | .565 | 14.35 | .333 | 8.46 | .185 | 4.70 | .325 | 8.26 | 1.150 | 29.21 | .465 | 11.81 | .183 | 4.65 | .125 | 3.18 | .150 | 3.81 |
| 9S | 1.390 | 35.31 | .565 | 14.35 | .400 | 10.16 | .253 | 6.26 | .325 | 8.26 | 1.150 | 29.21 | .465 | 11.81 | .195 | 4.95 | .125 | 3.18 | .150 | 3.81 |
| 15P | 1.540 | 39.12 | .715 | 18.16 | .483 | 12.27 | .185 | 4.70 | .325 | 8.26 | 1.300 | 33.02 | .465 | 11.81 | .183 | 4.65 | .125 | 3.18 | .150 | 3.81 |
| 15S | 1.540 | 39.12 | .715 | 18.16 | .551 | 14.00 | .253 | 6.26 | .325 | 8.26 | 1.300 | 33.02 | .465 | 11.81 | .195 | 4.95 | .125 | 3.18 | .150 | 3.81 |
| 21P | 1.690 | 42.93 | .865 | 21.97 | .633 | 16.08 | .185 | 4.70 | .325 | 8.26 | 1.450 | 36.83 | .465 | 11.81 | .183 | 4.65 | .125 | 3.18 | .150 | 3.81 |
| 21S | 1.690 | 42.93 | .865 | 21.97 | .701 | 17.81 | .253 | 6.26 | .325 | 8.26 | 1.450 | 36.83 | .465 | 11.81 | .195 | 4.95 | .125 | 3.18 | .150 | 3.81 |
| 25P | 1.790 | 45.47 | .965 | 24.51 | .733 | 18.62 | .185 | 4.70 | .325 | 8.26 | 1.550 | 39.37 | .465 | 11.81 | .183 | 4.65 | .125 | 3.18 | .150 | 3.81 |
| 25S | 1.790 | 45.47 | .965 | 24.51 | .801 | 20.35 | .253 | 6.26 | .325 | 8.26 | 1.550 | 39.37 | .465 | 11.81 | .195 | 4.95 | .125 | 3.18 | .150 | 3.81 |
| 31P | 2.040 | 51.82 | 1.115 | 28.32 | .883 | 22.43 | .185 | 4.70 | .325 | 8.26 | 1.800 | 45.72 | .465 | 11.81 | .183 | 4.65 | .125 | 3.18 | .150 | 3.81 |
| 31S | 2.040 | 51.82 | 1.115 | 28.32 | .951 | 24.16 | .253 | 6.26 | .325 | 8.26 | 1.800 | 45.72 | .465 | 11.81 | .195 | 4.95 | .125 | 3.18 | .150 | 3.81 |
| 37P | 2.340 | 59.44 | 1.265 | 32.13 | 1.033 | 26.24 | .185 | 4.70 | .325 | 8.26 | 2.100 | 53.34 | .465 | 11.81 | .183 | 4.65 | .125 | 3.18 | .150 | 3.81 |
| 37S | 2.340 | 59.44 | 1.265 | 32.13 | 1.101 | 27.96 | .253 | 6.26 | .325 | 8.26 | 2.100 | 53.34 | .465 | 11.81 | .195 | 4.95 | .125 | 3.18 | .150 | 3.81 |
| 51P | 1.875 | 47.63 | 1.215 | 30.86 | .983 | 24.97 | .228 | 5.79 | .360 | 9.14 | 1.600 | 40.64 | .565 | 14.35 | .183 | 4.65 | .125 | 3.18 | .150 | 3.81 |
| 51S | 1.875 | 47.63 | 1.215 | 30.86 | 1.051 | 26.70 | .296 | 7.52 | .360 | 9.14 | 1.600 | 40.64 | .565 | 14.35 | .195 | 4.95 | .125 | 3.18 | .150 | 3.81 |
| 100P | 2.780 | 70.60 | 1.800 | 45.72 | 1.383 | 35.13 | .271 | 6.88 | .420 | 10.67 | 2.500 | 63.50 | .765 | 19.43 | .183 | 4.65 | .225 | 5.72 | .150 | 3.81 |
| 100S | 2.780 | 70.60 | 1.800 | 45.72 | 1.451 | 36.86 | .333 | 8.64 | .420 | 10.67 | 2.500 | 63.50 | .765 | 19.43 | .195 | 4.95 | .225 | 5.72 | .150 | 3.81 |



MIL-DTL-83513/16 Thru /21 Micro-D BR Right Angle PCB Terminated Connector

M83513/16 Thru /18 PCB Layouts – Pin Connectors

Patterns shown are for connector mounting side of PC board. 9 Thru 51 Contacts .096 (2.44) Diameter Mounting Holes, 100 Pin .125 (3.18) Diameter



9 PIN M83513/16-A



25 PIN M83513/16-D



15 PIN M83513/16-B



31 PIN M83513/16-E



21 PIN M83513/16-C



37 PIN M83513/16-F



51 PIN M83513/17-G



100 PIN M83513/18-H

M83513/19 Thru /21 PCB Layouts – Socket Connectors

Patterns shown are for connector mounting side of PC board. 9 Thru 51 Contacts .096 (2.44) Diameter Mounting Holes, 100 Pin .125 (3.18) Diameter



9 SOCKET M83513/19-A



25 SOCKET M83513/19-D



15 SOCKET M83513/19-B



31 SOCKET M83513/19-E



21 SOCKET M83513/19-C



37 SOCKET M83513/19-F



51 SOCKET M83513/20-G



100 SOCKET M83513/21-H



MIL-DTL-83513/22 Thru /27 Micro-D BS Straight PCB Terminated Connector



High Performance

These connectors feature goldplated TwistPin contacts for best performance. PC tails are .020 inch diameter. Specify nickel-plated shells or cadmium plated shells for best availability.

Solder-Dipped

Terminals are coated with Sn60/Pb40 tin-lead solder for best solderability.

How To Order MIL-DTL-83513 Straight PCB Micro-D Connectors

| Sample Part Number | M83513/ | /26-G | 03 | C | W |
|--------------------------|---|-------|--|---|---|
| Base Part Number | M83513 | | | | |
| Slash Number-Shell Sizes | Plug (Pin Contacts) | | Receptacle (Socket Contacts) | | |
| | 22-A – 9 Contacts 22-B – 15 Contacts 22-C – 21 Contacts 22-D – 25 Contacts 22-E – 31 Contacts 22-F – 37 Contacts 23-G – 51 Contacts 24-H – 100 Contacts (See Table I) | | 25-A – 9 Contacts 25-B – 15 Contacts 25-C – 21 Contacts 25-D – 25 Contacts 25-E – 31 Contacts 25-F – 37 Contacts 26-G – 51 Contacts 27-H – 100 Contacts | | |
| PC Tail Length | 01 - .109 Inch (2.77 mm) 02 - .140 Inch (3.56 mm) 03 - .172 Inch (4.37 mm) | | PC Tail Length ± .015 (0.38) | | |
| Shell Finish | C - Cadmium N - Electroless Nickel P - Passivated SST | | A - Electrodeposited Aluminum K - Zinc Nickel T - Nickel Fluorocarbon Polymer | | |
| Hardware Options | N - No Jackpost | | P - Jackposts Installed | | |
| | Sizes 9-51 T - Threaded Insert in Board Mount Hole (No Jackposts) W - Threaded Insert in Board Mount Hole and jackposts Installed Shell Size 100 (H) U - #4-40 Threaded Insert Y - #4-40 Threaded Insert & Jackpost (See Table I) | | | | |

Table I: Hardware options

| N | P | T or U | W or Y |
|-------------------------------------|----------------------------------|---|---|
| <p>Thru Hole</p> <p>No Jackpost</p> | <p>Thru Hole</p> <p>Jackpost</p> | <p>Threaded Insert</p> <p>Threaded Insert</p> | <p>Threaded Insert</p> <p>Jackpost, Threaded Insert</p> |

MIL-DTL-83513/22 Thru /27 Micro-D BS Straight PCB Terminated Connector



Micro-D
MIL-DTL-83513

Table II: Dimensions



THREAD SIZES
9-51 CONTACTS #2-56 UNC
100 CONTACTS #4-40 UNC

| Layout | A Max. | | B | | C Max. | | D Max. | | E Max. | | F | | G | | H | | J Max. | | K | |
|-------------|--------|-------|--------------|---------------|--------|-------|--------|------|--------|-------|--------------|--------------|--------------|--------------|--------------|--------------|--------|-------|--------------|--------------|
| | In. | mm. | In. ±.003 | mm. ± 0.08 | In. | mm. | In. | mm. | In. | mm. | In. ±.004 | mm. ±0.10 | In. ±.010 | mm. ±0.25 | In. ±.007 | mm. ±0.18 | In. | mm. | In. ±.010 | mm. ±0.25 |
| 9P | .790 | 20.07 | .565 | 14.35 | .333 | 8.46 | .184 | 4.67 | .310 | 7.87 | .183 | 4.65 | .333 | 8.46 | 1.150 | 29.21 | 1.390 | 35.31 | .155 | 3.94 |
| 9S | .790 | 20.07 | .565 | 14.35 | .400 | 10.16 | .250 | 6.35 | .310 | 7.87 | .195 | 4.95 | .333 | 8.46 | 1.150 | 29.21 | 1.390 | 35.31 | .155 | 3.94 |
| 15P | .940 | 23.88 | .715 | 18.16 | .483 | 12.27 | .184 | 4.67 | .310 | 7.87 | .183 | 4.65 | .333 | 8.46 | 1.150 | 29.21 | 1.390 | 35.31 | .155 | 3.94 |
| 15S | .940 | 23.88 | .715 | 18.16 | .551 | 14.00 | .250 | 6.35 | .310 | 7.87 | .195 | 4.95 | .333 | 8.46 | 1.150 | 29.21 | 1.390 | 35.31 | .155 | 3.94 |
| 21P | 1.180 | 29.97 | .865 | 21.97 | .633 | 16.08 | .184 | 4.67 | .310 | 7.87 | .183 | 4.65 | .333 | 8.46 | 1.450 | 36.83 | 1.690 | 42.93 | .155 | 3.94 |
| 21S | 1.180 | 29.97 | .865 | 21.97 | .701 | 17.81 | .250 | 6.35 | .310 | 7.87 | .195 | 4.95 | .333 | 8.46 | 1.450 | 36.83 | 1.690 | 42.93 | .155 | 3.94 |
| 25P | 1.275 | 32.39 | .965 | 24.51 | .733 | 18.62 | .184 | 4.67 | .310 | 7.87 | .183 | 4.65 | .333 | 8.46 | 1.500 | 38.10 | 1.740 | 44.20 | .155 | 3.94 |
| 25S | 1.275 | 32.39 | .965 | 24.51 | .801 | 20.35 | .250 | 6.35 | .310 | 7.87 | .195 | 4.95 | .333 | 8.46 | 1.500 | 38.10 | 1.740 | 44.20 | .155 | 3.94 |
| 31P | 1.575 | 40.01 | 1.115 | 28.32 | .883 | 22.43 | .184 | 4.67 | .310 | 7.87 | .183 | 4.65 | .333 | 8.46 | 1.800 | 45.72 | 2.040 | 51.82 | .155 | 3.94 |
| 31S | 1.575 | 40.01 | 1.115 | 28.32 | .951 | 24.16 | .250 | 6.35 | .310 | 7.87 | .195 | 4.95 | .333 | 8.46 | 1.800 | 45.72 | 2.040 | 51.82 | .155 | 3.94 |
| 37P | 1.875 | 47.63 | 1.265 | 32.13 | 1.033 | 26.24 | .184 | 4.67 | .310 | 7.87 | .183 | 4.65 | .333 | 8.46 | 2.100 | 53.34 | 2.340 | 59.44 | .155 | 3.94 |
| 37S | 1.875 | 47.63 | 1.265 | 32.13 | 1.101 | 27.96 | .250 | 6.35 | .310 | 7.87 | .195 | 4.95 | .333 | 8.46 | 2.100 | 53.34 | 2.340 | 59.44 | .155 | 3.94 |
| 51P | 1.775 | 45.09 | 1.215 | 30.86 | .983 | 24.97 | .228 | 5.79 | .351 | 8.92 | .183 | 4.65 | .333 | 8.46 | 2.000 | 50.80 | 2.270 | 57.64 | .155 | 3.94 |
| 51S | 1.775 | 45.09 | 1.215 | 30.86 | 1.051 | 26.70 | .296 | 7.52 | .351 | 8.92 | .195 | 4.95 | .333 | 8.46 | 2.000 | 50.80 | 2.270 | 57.64 | .155 | 3.94 |
| 100P | 2.585 | 65.66 | 1.800 | 45.72 | 1.383 | 35.13 | .270 | 6.86 | .460 | 11.68 | .183 | 4.65 | .525 | 13.34 | 2.800 | 71.12 | 3.250 | 82.55 | .293 | 7.44 |
| 100S | 2.585 | 65.66 | 1.800 | 45.72 | 1.451 | 36.86 | .333 | 8.46 | .460 | 11.68 | .195 | 4.95 | .525 | 13.34 | 2.800 | 71.12 | 3.250 | 82.55 | .293 | 7.44 |



MIL-DTL-83513/22 Thru /27 Micro-D BS Straight PCB Terminated Connector

M83513/22 Thru /24 PCB Layouts – Pin Connectors

Patterns shown are for connector mounting side of PC board. 9 Thru 51 Contacts .096 (2.44) Diameter Mounting Holes, 100 Pin .125 (3.18) Diameter



Connector Orientation



M83513/25 Thru /27 PCB Layouts – Socket Connectors

Patterns shown are for connector mounting side of PC board. 9 Thru 51 Contacts .096 (2.44) Diameter Mounting Holes, 100 Pin .125 (3.18) Diameter



9 SOCKET M83513/25-A



51 SOCKET M83513/26-G



15 SOCKET M83513/25-B



31 SOCKET M83513/25-E



21 SOCKET M83513/25-C



25 SOCKET M83513/25-D

Connector Orientation



37 SOCKET M83513/25-F

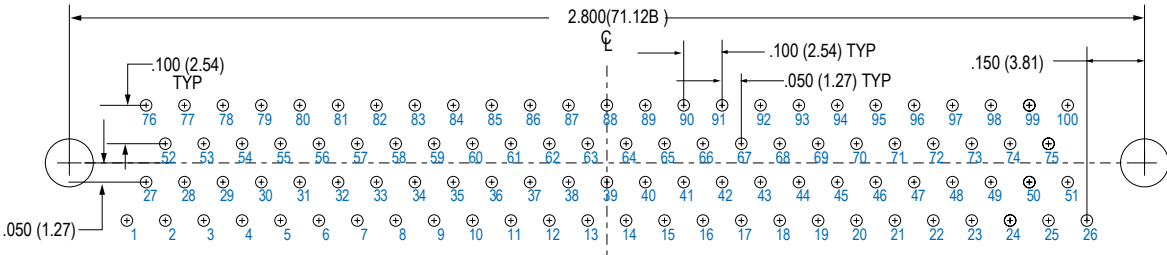

100 SOCKET M83513/27-H



MIL-DTL-83513/28 Thru /33 Micro-D CBS Condensed Straight PCB Terminated Connectors



Space-Saving — These connectors take up less room on the PC board. PC tail spacing is .075 inch (1.9mm) between rows.

Threaded Inserts — Stainless steel inserts are insert molded into plastic trays. These inserts provide a ground path from the PC board to the mating cable.

Solder-Dipped — Terminals are coated with Sn60/Pb40 tin-lead solder for best solderability.

How To Order Straight PCB Micro-D Connectors

| | | | | | | | | | | | | | | | | |
|---------------------------------|--|---------------------------------|---------------------------------|---|---------------------------|---------------------------|---------------------------|---------------------------|---------------------------|---------------------------|---------------------------|---------------------------|---------------------------|----------------------------|---------------------------|----------------------------|
| Sample Part Number | M83513/ | | | | | 33-H | 01 | C | P | | | | | | | |
| Base Part Number | M83513/ | | | | | | | | | | | | | | | |
| Slash Number-Shell Sizes | Plug (Pin Contacts) | | | Receptacle (Socket Contacts) | | | | | | | | | | | | |
| | 28-A - 9 Contacts | 28-E - 31 Contacts | 31-A - 9 Contacts | 31-E - 31 Contacts | 28-B - 15 Contacts | 28-F - 37 Contacts | 31-B - 15 Contacts | 31-F - 37 Contacts | 28-C - 21 Contacts | 29-G - 51 Contacts | 31-C - 21 Contacts | 32-G - 51 Contacts | 28-D - 25 Contacts | 30-H - 100 Contacts | 31-D - 25 Contacts | 33-H - 100 Contacts |
| | (See Table II) | | | | | | | | | | | | | | | |
| PC Tail Length | 01 - .109 Inch (2.77 mm) | 02 - .140 Inch (3.56 mm) | 03 - .172 Inch (4.37 mm) | | | | | | | | | | | | | |
| | PC Tail Length ± .015 (0.38) | | | | | | | | | | | | | | | |
| Shell Finish | C - Cadmium | | | A - Electrodeposited Aluminum | | | | | | | | | | | | |
| | N - Electroless Nickel | | | K - Zinc Nickel | | | | | | | | | | | | |
| | P - Passivated SST | | | T - Nickel Fluorocarbon Polymer | | | | | | | | | | | | |
| Hardware Options | N - No Jackpost | | | P - Jackposts Installed | | | | | | | | | | | | |
| | Sizes 9-51 | | | Shell Size 100 (H) | | | | | | | | | | | | |
| | T - Threaded Insert in Board Mount Hole (No Jackposts) | | | U - #4-40 Threaded Insert | | | | | | | | | | | | |
| | W - Threaded Insert in Board Mount Hole and Jackposts Installed | | | Y - #4-40 Threaded Insert & Jackpost | | | | | | | | | | | | |
| | (See Table I) | | | | | | | | | | | | | | | |

Table I: Hardware Options

| HARDWARE OPTION N NO JACKPOST, NO THREADED INSERT | HARDWARE OPTIONS T or U THREADED INSERT, NO POST | HARDWARE OPTION P JACKPOST AND THRU-HOLE | HARDWARE OPTIONS W or Y JACKPOST AND THREADED INSERT |
|--|---|--|---|
| | | | |
| MTNG HOLE DIA. 9-51 CONTACTS .096/.088 (2.44/2.24) 100 CONTACTS .128/.122 (3.25/3.10) | THREAD SIZE 9-51 CONTACTS # 2-56 UNC-2B 100 CONTACTS # 4-40 UNC-2B | THREAD SIZE 9-51 CONTACTS # 2-56 UNC 100 CONTACTS # 4-40 UNC USE WITH .156 (3.96) MAX. PC BOARD THICKNESS | THREAD SIZE 9-51 CONTACTS #2-56 UNC 100 CONTACTS #4-40 UNC |

MIL-DTL-83513/28 Thru /33 Micro-D CBS Condensed Straight PCB Terminated Connectors



Micro-D
MIL-DTL-83513

Table III: Dimensions



| Layout | A Max. | | B | | C Max. | | D Max. | | E Max. | | F | | G Max. | |
|--------|--------|-------|---------------|---------------|--------|-------|--------|------|--------|-------|---------------|---------------|--------|-------|
| | In. | mm. | In. ± .005 | mm. ± 0.13 | In. | mm. | In. | mm. | In. | mm. | In. ± .003 | mm. ± 0.08 | In. | mm. |
| 9P | .785 | 19.94 | .565 | 14.35 | .333 | 8.46 | .185 | 4.70 | .310 | 7.87 | .183 | 4.65 | .355 | 9.02 |
| 9S | .785 | 19.94 | .565 | 14.35 | .400 | 10.16 | .253 | 6.43 | .310 | 7.87 | .195 | 4.95 | .355 | 9.02 |
| 15P | .935 | 23.75 | .715 | 18.16 | .483 | 12.27 | .185 | 4.70 | .310 | 7.87 | .183 | 4.65 | .355 | 9.02 |
| 15S | .935 | 23.75 | .715 | 18.16 | .551 | 14.00 | .253 | 6.43 | .310 | 7.87 | .195 | 4.95 | .355 | 9.02 |
| 21P | 1.085 | 27.56 | .865 | 21.97 | .633 | 16.08 | .185 | 4.70 | .310 | 7.87 | .183 | 4.65 | .355 | 9.02 |
| 21S | 1.085 | 27.56 | .865 | 21.97 | .701 | 17.81 | .253 | 6.43 | .310 | 7.87 | .195 | 4.95 | .355 | 9.02 |
| 25P | 1.185 | 30.01 | .965 | 24.51 | .733 | 18.62 | .185 | 4.70 | .310 | 7.87 | .183 | 4.65 | .355 | 9.02 |
| 25S | 1.185 | 30.01 | .965 | 24.51 | .801 | 20.35 | .253 | 6.43 | .310 | 7.87 | .195 | 4.95 | .355 | 9.02 |
| 31P | 1.335 | 33.91 | 1.115 | 28.32 | .883 | 22.43 | .185 | 4.70 | .310 | 7.87 | .183 | 4.65 | .355 | 9.02 |
| 31S | 1.335 | 33.91 | 1.115 | 28.32 | .951 | 24.16 | .253 | 6.43 | .310 | 7.87 | .195 | 4.95 | .355 | 9.02 |
| 37P | 1.485 | 37.72 | 1.265 | 32.13 | 1.033 | 26.24 | .185 | 4.70 | .310 | 7.87 | .183 | 4.65 | .355 | 9.02 |
| 37S | 1.485 | 37.72 | 1.265 | 32.13 | 1.101 | 27.96 | .253 | 6.43 | .310 | 7.87 | .195 | 4.95 | .355 | 9.02 |
| 51P | 1.435 | 36.45 | 1.215 | 30.86 | .983 | 24.97 | .228 | 5.79 | .400 | 10.16 | .183 | 4.65 | .355 | 9.02 |
| 51S | 1.435 | 36.45 | 1.215 | 30.86 | 1.051 | 26.70 | .296 | 7.52 | .400 | 10.16 | .195 | 4.95 | .355 | 9.02 |
| 100P | 2.170 | 55.12 | 1.800 | 45.72 | 1.383 | 35.13 | .271 | 6.88 | .510 | 12.95 | .183 | 4.65 | .430 | 10.92 |
| 100S | 2.170 | 55.12 | 1.800 | 45.72 | 1.451 | 36.86 | .333 | 8.46 | .510 | 12.95 | .195 | 4.95 | .430 | 10.92 |





MIL-DTL-83513/28 Thru /33 Micro-D CBS Condensed Straight PCB Terminated Connectors

M83513/28 Thru 30 PCB Layouts – Pin Connectors

Patterns shown are for connector mounting side of PC board.



9 PIN M83513/28-A



15 PIN M83513/28-B

Connector Orientation



Pin #1



21 PIN M83513/28-C



25 PIN M83513/28-D



31 PIN M83513/28-E



37 PIN M83513/28-F



51 PIN M83513/29-G



100 PIN M83513/30-H

MM83513/31 Thru /33 PCB Layouts – Socket Connectors

Patterns shown are for connector mounting side of PC board.



9 SOCKET M83513/31-A



15 SOCKET M83513/31-B

Connector Orientation



21 SOCKET M83513/31-C



25 SOCKET M83513/31-D



31 SOCKET M83513/31-E



37 SOCKET M83513/31-F



51 SOCKET M83513/32-G



100 Socket M83513/33-H



MIL-DTL-83513/05 Micro-D Hardware Jackscrews and Jackposts



Order One Kit Per Connector.

Jackpost kits contain two posts, two hex nuts and 2 lockwashers. Jackscrew kits contain 2 screws and 2 e-rings.

MIL Spec Hardware Kits

feature 300 series stainless steel.

| MIL Spec Jackscrew Kits | | | | |
|--|---|----------------------|---------------------|--|
| Configuration | Connector Size, Thread Size | Mil Spec Part Number | Glenair Part Number | Dimensions |
|  Jackpost | Sizes 9 to 69 Contacts. Mil Spec Size A to G #2-56 UNC | M83513/05-07 | 080-00-00-100 |  |
| | 75-130 Mil Spec Size H #4-40 UNC | M83513/05-17 | 080-00-00-101 |  |
|  Hex Head Jackscrew Low Profile | Sizes 9 to 69 Contacts. Mil Spec Size A to G #2-56 UNC-2A | M83513/05-02 | 080-00-00-502 |  |
| | 75-130 Mil Spec Size H #4-40 UNC-2A | M83513/05-12 | 080-00-00-512 |  |
|  Slot Head Jackscrew Low Profile | Sizes 9 to 69 Contacts. Mil Spec Size A to G #2-56 UNC-2A | M83513/05-05 | 080-00-00-505 |  |
| | 75-130 Mil Spec Size H #4-40 UNC-2A | M83513/05-15 | 080-00-00-515 |  |
|  Hex Head Jackscrew Extended | Sizes 9 to 69 Contacts. Mil Spec Size A to G #2-56 UNC-2A | M83513/05-03 | 080-00-00-503 |  |
| | 75-130 Mil Spec Size H #4-40 UNC-2A | M83513/05-13 | 080-00-00-513 |  |
|  Slot Head Jackscrew Extended | Sizes 9 to 69 Contacts. Mil Spec Size A to G #2-56 UNC-2A | M83513/05-06 | 080-00-00-506 |  |
| | 75-130 Mil Spec Size H #4-40 UNC-2A | M83513/05-16 | 080-00-00-516 |  |

Product Selection Guide

Round Cable Entry
Backshell
Page M-6



EMI/RFI Round Cable Entry Backshells

One piece aluminum Micro-D backshells. Terminate cable shields with BandMaster™ ATS stainless steel straps. Finish the cable with heat-shrink tubing or boots, sold separately. Stocked in top, side, 45°, dual 45° and dual top entry. MIL-DTL-83513 version also available.

Round Cable Entry, Split
Shell Banding Backshell
Page M-9



Split EMI/RFI Micro-D Backshell with and Screwlocks

This backshell features screwlocks, allowing the connectors to be fully mated before the hardware is fastened.

Round Cable Entry
Shield Sock
Page M-10



EMI/RFI Micro-D Backshells With Braid Attached

These backshells are terminated to tinned copper braid.

Composite Round
Cable Entry
Page M-12



Round Entry Split EMI/RFI Micro-D Backshell and Screwlocks

This backshell features screwlocks, allowing the connectors to be fully mated before the hardware is fastened.

Elliptical Entry
Page M-14



Elliptical Entry EMI/RFI Micro-D Backshells

Our elliptical backshells accommodate larger wire bundles. See the table on page M-5 for more information.

Elliptical Split Banding
Backshell
Page M-21



Elliptical EMI/RFI Split Shell Micro-D Backshell

This backshell features screwlocks, allowing the connectors to be fully mated before the hardware is fastened.

Strain Relief
Page M-23



Strain Relief Backshells (not for EMI)

These backshells are used for wire or cable strain relief. Three styles are provided.

Potting Shell
Page M-26



Potting Shell (not for EMI)

Potting shells are attached to the connector and filled with epoxy or similar encapsulants to provide environmental protection and strain relief.



Micro-D Backshells General Information and Product Selection Guide

Micro-D Backshell Selection Guide

| | Backshell Type | | | | | | | | | | Cable Entry | | | | Hardware | | | | Other | | | | Page Number |
|---------|----------------|------------------------------------|-------------------------|---------------|-----------------|----------------------|------------------------|----------------------|-----------------|------------------|-----------------------|---------------------|---------------------|------------------|---------------------|-----------------------------|------------------------------|---------------------------|------------------------------|--------------------------------|--------------------------------------|------|-------------|
| | EMI backshell | Available in Lightweight Composite | Strain Relief Backshell | Potting Shell | Switching Shell | Circular Cable Entry | Elliptical Cable Entry | Straight Cable Entry | 45° Cable Entry | Side Cable Entry | Slot Head Cable Entry | Hex Head Jackscrews | Extended Jackscrews | Screw Jackscrews | One Piece Backshell | Split (Two Piece) Backshell | Accepts Standard Shield Band | Accepts Micro Shield Band | Connector Attaches with Clip | Connector Attaches with E-Ring | Connector is Captivated by Backshell | | |
| 500-010 | ● | | | | | ● | | ● | ● | ● | ● | (1) | | ● | | ● | ● | | | | | M-6 | |
| 500-011 | ● | | | | | ● | | ● | ● | ● | ● | (1) | | ● | | | ● | | | | | M-10 | |
| 500-012 | | ● | | | | ● | | ● | ● | ● | ● | (1) | | ● | | | ● | | | | | M-25 | |
| 500-047 | ● | | | | | | ● | ● | | | ● | ● | | ● | | ● | ● | | | | | M-14 | |
| 507-035 | | | ● | | | | | | | | ● | ● | | ● | | | ● | | | | | M-26 | |
| 507-088 | ● | ● | | | | ● | | ● | ● | ● | ● | (1) | | ● | | | ● | | | | | M-12 | |
| 507-145 | ● | | | | | ● | | ● | | | | | ● | | ● | | | | ● | | | M-9 | |
| 507-146 | | ● | | | | | | | | ● | ● | ● | | ● | | ● | (2) | (2) | | | | M-24 | |
| 507-175 | ● | | | | | | ● | ● | ● | (3) | ● | ● | | ● | | | ● | | | | | M-15 | |
| 507-178 | ● | | | | | | ● | ● | | | | | ● | | ● | | | | | ● | | M-21 | |
| 507-198 | | ● | | | | | ● | | | | ● | ● | | ● | | | ● | | | | | M-23 | |

- (1) Extended jackscrew will not work with 45° cable entry or with dual 45° entry backshells.
- (2) Sizes 9 thru 69 use e-rings or c-clips for connector attachment, 100 pin uses c-clip only.
- (3) The cable entry is on the long side of shell. See ordering information for clarification.

Glenair Qwik Connections

| | 500-010 | 500-011 | 500-012 | 500-047 | 507-035 | 507-088 | 507-145 | 507-146 | 507-175 | 507-178 | 507-198 |
|---|---------|---------|---------|---------|---------|---------|---------|---------|---------|---------|---------|
| Same Day Stock* | A | C | A | A | A | C | B | A | D | D | D |
| Lightest Weight | | | | | | ● | | | | | |
| Accepts Standard Width Shield Band | ● | | | ● | | | | | | | |
| Meets NASA Outgassing | ● | ● | ● | ● | ● | ● | ● | ● | ● | ● | |
| Low Residual Magnetism | | | | | | | ● | | | ● | |
| Oversize Elliptical Cable Entry | | | | ● | | | | ● | ● | | |
| Split Backshell With Screwlocks for Fast Mating | | | | | | | ● | | | ● | |

*Availability: **A** — All sizes in stock. **B** — Most sizes in stock. **C** — A few sizes in stock. **D** — Not Stocked.

M

Micro-D Backshells General Information and Reference Data



About Micro-D Backshells

Micro-D EMI backshells connect cable shields to Micro-D connectors, providing strain relief and mechanical protection. These backshells are made out of aluminum alloy. Electroless nickel is the most widely used finish. These backshells are compatible with industry-standard metal shell M83513 type connectors. The following application notes explain how to select the right type of backshell.

EMI Versus Non-EMI Backshells

Select EMI backshells if your cable has a braided copper shield. The cable shield is secured to the backshell with a BandMaster™ ATS strap, supplied with the backshell or purchased separately.

Select a strain relief backshell if your connector has individual wires or if your wire bundle does not have a metal shield.

EMI backshells do not normally require additional strain relief. Micro-D wires are typically potted, and the shield braid is a sufficient strain relief. An optional ty-wrap leg is available if necessary. Add "S" to the end of the part number.



Standard Band Versus Micro Band

Most Micro-D EMI backshells feature low profile band platforms designed for narrow (.125" width) micro band. Some have a taller band platform which also accepts standard bands (.250" width). Please refer to the "Backshell Selection Guide" on the preceding page to identify which backshells are compatible with both the standard band and the micro band.



One Piece Backshell Versus Split Backshell

Use one piece backshells if in stock availability is important. Split backshells allow installation after the other end of the cable has been terminated. Some split backshells fit over the connector, eliminating the highly magnetic clip. Split versions also can accommodate screw locks.

Jackscrews and Screwlocks

Jackscrews are fixed in position and must be turned in order to mate the connectors together. Screwlocks float and allow the connectors to be coupled before the screwlocks are engaged. Screwlocks allow faster mating, while jackscrews offer less risk of contact damage.

Elliptical Versus Circular Cable Entry

Choose elliptical backshells if the wire bundle diameter is too big to fit in a circular cable entry. Large Micro-D connectors (51 pins and up) usually exceed the limits of the round entries. Refer to the cable entry and wire bundle tables in this section to find out if an elliptical entry is necessary.

The actual size illustrations to the right show the difference between round and elliptical cable entries. The round entry circular mil area = $\frac{1}{2}(\frac{1}{2}D)^2 = .11 \text{ In.}^2$. The formula for the area of an ellipse is $\frac{1}{2}(\text{Length})(\text{Width}) \div 4 = .36 \text{ In.}^2$



Round Cable Entry

100 Pin .375 Inch (9.5 mm.) Diameter



Elliptical Cable Entry

100 Pin .360 By 1.29 Inch (9.1 X 32.8 mm.)



Micro-D Backshells General Information and Reference Data

BandMaster® ATS Shield Termination System

Fast, Cost-Effective Shield Termination

Attach cable braid shields to EMI backshells with **BandMaster® ATS** stainless steel straps. The **Band-Master® ATS** system offers fast termination and the flexibility to handle different diameters with the same band.

The aerospace industry has adopted this system for every type of application where reliability and durability are essential.

IMPORTANT NOTE: ALWAYS DOUBLE-WRAP BANDS!

Contact Glenair or visit our website (www.glenair.com) to view our complete line of **BandMaster® ATS** products, including pneumatic tools for high production and calibration kits.

The New BandMaster™ ATS Micro Band Tool

Part Number **600-061**

without counter

Part Number **601-101**

with counter

Weight: 1.18 lbs.

See our full offering of Band-Master™ ATS tools and accessories at <http://www.glenair.com/catalogs/bandmaster.pdf>



Medium Micro Band

8.0 Inches (203.2 mm.) part

number **601-060** standard or

601-061 Pre-coiled up to

.88 Inches (22.4 mm.) Diameter



Long Micro Band

14.0 inches (355.6 mm.) part

Number **601-064** standard or

601-065 pre-coiled up to

1.88 Inches (47 mm) diameter



M

Step One

Cable Prep

Lay individual shields over the band platform. Pull overall braid shield over the band platform so that all braid strands will be captured by the band.

Step Two

Install Band

Wrap the band through the buckle twice. Insert the working end into the banding tool in the direction shown on the tool. Squeeze the short grey handle to insert the band. Slide the band onto the cable. Close the blue handle repeatedly until the handle no longer opens. Close the long grey handle until the tool cuts the band. Remove the excess strap from the tool by closing the small grey handle.

*Visit the Glenair Website for video demonstrations of banding termination at <http://www.glenair.com/banding/index.htm>

Step Three

Trim Braid

It's a snap! Just trim the excess braid and you're done.

Micro-D Backshells

Micro-D Backshell Wire Bundle Sizing Chart and Material and Finish Options



| Maximum Discrete Wire Bundle Diameters (See Note 1) | | | | | |
|---|------------|----------------------|--|----------------------|--|
| No. Of Wires | Wire Gauge | M22759/11 | | M22759/33 | |
| | | Wire Bundle Diameter | Recommended Backshell Cable Entry Code | Wire Bundle Diameter | Recommended Backshell Cable Entry Code |
| 9 | #24 | 0.153 (3.90) | 06 | 0.132 (3.40) | 05 |
| 9 | #26 | 0.136 (3.50) | 05 | 0.115 (2.90) | 05 |
| 9 | #28 | 0.119 (3.00) | 05 | 0.098 (2.50) | 04 |
| 15 | #24 | 0.197 (5.00) | 08 | 0.171 (4.30) | 06 |
| 15 | #26 | 0.175 (4.40) | 07 | 0.149 (3.80) | 06 |
| 15 | #28 | 0.153 (3.90) | 06 | 0.127 (3.20) | 05 |
| 21 | #24 | 0.233 (5.90) | 09 | 0.202 (5.10) | 07 |
| 21 | #26 | 0.207 (5.30) | 08 | 0.176 (4.50) | 07 |
| 21 | #28 | 0.181 (4.60) | 07 | 0.150 (3.80) | 06 |
| 25 | #24 | 0.254 (6.50) | * | 0.220 (5.60) | 08 |
| 25 | #26 | 0.226 (5.70) | 09 | 0.192 (4.90) | 07 |
| 25 | #28 | 0.198 (5.00) | 08 | 0.164 (4.20) | 06 |
| 31 | #24 | 0.283 (7.20) | * | 0.245 (6.20) | 09 |
| 31 | #26 | 0.252 (6.40) | 09 | 0.214 (5.40) | 08 |
| 31 | #28 | 0.220 (5.60) | 08 | 0.182 (4.60) | 07 |
| 37 | #24 | 0.309 (7.90) | * | 0.268 (6.80) | * |
| 37 | #26 | 0.275 (7.00) | * | 0.234 (5.90) | 09 |
| 37 | #28 | 0.241 (6.10) | 09 | 0.199 (5.10) | 08 |
| 51 | #24 | 0.363 (9.20) | * | 0.315 (8.00) | * |
| 51 | #26 | 0.323 (8.20) | * | 0.274 (7.0) | 10 |
| 51 | #28 | 0.282 (7.20) | * | 0.234 (5.90) | 09 |
| 100 | #24 | .509 (12.9) | * | 0.441 (11.2) | * |
| 100 | #26 | .452 (11.5) | * | 0.384 (9.80) | * |
| 100 | #28 | .396 (10.1) | * | 0.328 (8.30) | * |

*Glenair recommends elliptical style backshell

NOTES:

1. This sizing chart is for discrete wire bundles of the type and gauge indicated. When using twisted pairs, or other wire types/configurations, refer to Glenair Circular Connector Backshells & Accessories catalog, page 8, "Calculating Wire Bundle Diameter." Glenair recommends 70% area fill (wire bundle area to entry port area), not to exceed 80% area fill on Micro-D Backshells.
2. When solder-cup Micro-D connectors and low-profile backshells (short in height) are used in conjunction, the transition angle from the outer pins to the centralized entry port becomes severe and can increase the susceptibility to damage. Glenair recommends elliptical shaped entries to minimize angles of contact that can occur with round cable entries.
3. Blending and deburring/smoothing of internal geometry may not produce "perfectly" smooth, rounded features, but has a proven history of success in precluding wire abrasion damage. For additional wire protection, wrap wire bundle with Kapton tape in areas that may come into contact with cable entry transitions or other interior angles.
4. Glenair recommends that harness designs avoid excessive fill percentages and severe contact angles as previously described. For applications where these conditions must exist, consult our factory for appropriate additional design / workmanship solutions

| Finish Options | | | |
|----------------|---|----------------------------------|-------------------------------------|
| Finish Code | Description | Specification | Corresponding Connector Finish Code |
| C | Black Anodize | MIL-A-8625 Type II Class 2 | Code 4 |
| E | Chem Film | MIL-C-5541 Class 3 | Code 6 |
| J | Cadmium Plate Over Electroless Nickel with Yellow Chromate Conversion Coating | SAE-AMS-QQ-P-416 Type II Class 3 | Code 1 |
| M | Electroless Nickel | SAE-AMS-26074 Class 3 | Code 2 |
| NF | Olive Drab Cadmium Plate Over Electroless Nickel (1000 Hour Corrosion Rated) | SAE-AMS-QQ-P-416 | NF (Special order) |
| XM | Electroless Nickel (Composite Only) | SAE-AMS-26074 Class 3 | Code 2 |
| Z2 | Gold Plated | ASTM B488 | Code 5 |

| Materials | |
|--------------------------------|--|
| Shell, Saddle Clamps | Aluminum Alloy 6061 -T6 Per QQ-A-200, QQ-A-225 (Machined Components) Aluminum Alloy 6061-T6 Per QQ-A-591 (A380) (Die-Cast Components) |
| Clips, E-Rings | 17-7PH Stainless Steel |
| Jackscrews, Washers, Jackposts | 300 Series Stainless Steel, Passivated |





500-010 EMI/RFI Micro-D Banding Backshell Round Cable Entry



Glenair's Most Popular Micro-D Backshell is stocked in all sizes. Choose straight, side or 45° cable entry.

Rugged One-Piece Aluminum shell with stainless steel hardware, available in standard nickel plating, or choose optional finishes.

17-7PH Stainless Steel Clips attach the backshell to the connector. These backshells accept standard and micro BandMaster™ ATS shield termination straps.

How To Order EMI/RFI Backshells

| Sample Part Number | 500T010 | | | | M | 25 | H | 08 |
|-----------------------|---|--|--|--|---|----|---|----|
| Series | 500T010 - Top Entry 500E010 - 45° Entry | 500S010 - Side Entry 500D010 - Dual 45° | (See Table III) | | | | | |
| Shell Finish | A - Cadmium Plate/Bright Dip B - Cadmium Plate/Olive Drab B1 - Cadmium Plate/Olive Drab, Type II Class 1 J - Gold Iridite Over Cadmium; Plate Over Nickel M - Electroless Nickel | | N - Cadmium Plate/Olive Drab; Over Nickel NF - Cad/O. D. Over Electroless; Nickel (1000 Hour Salt Spray) T - Cadmium Plate/Bright Dip Over Nickel Z2 - Gold Plate Z1 - Passivate, Stainless; Steel Material | | | | | |
| Shell Size | 09, 15, 21, 25, 31, 37, 51, 51-2, 67, 69, 100 (See Table III) | | | | | | | |
| Hardware Option | B - (2) Fillister Head Jackscrew BJ - (2) Male Fillister Head H - (2) Hex Head Jackscrew HJ - (2) Male Hex E - (2) Extended Jackscrew | | EJ - (2) Male Extended (Style T and S Only) F - (2) Jackpost, Female FB - (1) Female Jackpost, (1) Male Fillister Head FH - (1) Female Jackpost, (1) Male Hex Socket N - No Hardware | | | | | |
| Cable Entry Code | 04 - .125 (3.2) 09 - .281 (7.1) | 05 - .156 (4.0) 10 - .312 (7.9) | 06 - .188 (4.8) 11 - .344 (8.7) | 07 - .219 (5.6) 12 - .375 (9.5) | 08 - .250 (6.4) (See Table I) | | | |
| EMI Band Strap Option | Omit (Leave Blank) - Band Not Included <i>Use the following codes to order band strap with the connector. For best availability, order band separately.</i> | | Standard Band - .250" Wide B - Uncoiled Band Included K - Coiled Band Included Micro Band - .125" Wide M - Uncoiled Band Included L - Coiled Band Included | | | | | |

M

Table I: Maximum Cable Entry Code

| Shell Size | Style E & T | Style D | Style S |
|------------|-------------|---------|---------|
| 9 | 08 | 06 | 09 |
| 15 | 08 | 08 | 10 |
| 21 | 08 | 08 | 10 |
| 25 | 08 | 08 | 12 |
| 31 | 09 | 09 | 12 |
| 37 | 09 | 09 | 12 |
| 51 | 10 | 10 | 12 |
| 51-2 | 09 | 09 | 12 |
| 67 | 09 | 09 | 12 |
| 69 | 10 | 10 | 12 |
| 100 | 12 | 12 | 12 |

Table II: Maximum Cable Entry Dimensions

| Cable Size | P ±.015 | | R Dia. Max | |
|------------|------------|------------|------------|------|
| | In. ± .015 | mm. ± 0.38 | In. | mm. |
| 04 | .125 | 3.2 | .296 | 7.5 |
| 05 | .156 | 4.0 | .327 | 8.3 |
| 06 | .188 | 4.8 | .359 | 9.1 |
| 07 | .219 | 5.6 | .390 | 9.9 |
| 08 | .250 | 6.4 | .421 | 10.7 |
| 09 | .281 | 7.1 | .452 | 11.5 |
| 10 | .312 | 7.9 | .484 | 12.3 |
| 11 | .344 | 8.7 | .515 | 13.1 |
| 12 | .375 | 9.5 | .546 | 13.7 |

Notes

1. Assembly identified with manufacturer's name and P/N
2. 51-2 shell size is for a special 51 position 2 row Micro D connector
3. Knurled or ribbed banding platform - manufacturer's option
4. EMI gasket mounts between mating connector and panel

Materials/Finish

- Shell: Aluminum Alloy 6061 -T6 Per QQ-A-200, QQ-A-225 (Machined Components)
Aluminum Alloy 6061-T6 Per QQ-A-591 (A380) (Die-Cast Components)
- Clips, E-Rings: 17-7PH Stainless Steel
- Jackscrews, Washers, Jackposts: 300 Series Stainless Steel, Passivated

500-010
EMI/RFI Micro-D Banding Backshell
Round Cable Entry



Table III: Dimensions



| Size | A Max. | | B Max. | | C | | D Max. | | E Max. | | F Max. | | G Max. | | H Max. | | J Max. | | K | | L Max. | | M Max. | | N Max. | |
|------|--------|-------|--------|-------|-------|-------|--------|-------|--------|-------|--------|-------|--------|-------|--------|-------|--------|-------|------|-------|--------|-------|--------|-------|--------|-------|
| | In. | mm. | In. | mm. | In. | mm. | In. | mm. | In. | mm. | In. | mm. | In. | mm. | In. | mm. | In. | mm. | In. | mm. | In. | mm. | In. | mm. | In. | mm. |
| 09 | .850 | 21.59 | .370 | 9.40 | .565 | 14.35 | .780 | 19.81 | .410 | 10.41 | .350 | 8.89 | .637 | 16.18 | .350 | 8.89 | .637 | 16.18 | .435 | 11.05 | 1.040 | 26.42 | 1.000 | 25.40 | .680 | 17.27 |
| 15 | 1.000 | 25.40 | .370 | 9.40 | .715 | 18.16 | .910 | 23.11 | .580 | 14.73 | .470 | 11.94 | .673 | 17.09 | .470 | 11.94 | .673 | 17.09 | .440 | 11.2 | 1.170 | 29.72 | 1.030 | 26.16 | .730 | 18.54 |
| 21 | 1.150 | 29.21 | .370 | 9.40 | .865 | 21.97 | 1.030 | 26.16 | .740 | 18.80 | .590 | 14.99 | .707 | 17.95 | .590 | 14.99 | .707 | 17.95 | .458 | 11.63 | 1.290 | 32.77 | 1.050 | 26.67 | .765 | 19.43 |
| 25 | 1.250 | 31.75 | .370 | 9.40 | .965 | 24.51 | 1.090 | 27.69 | .850 | 21.59 | .650 | 16.51 | .748 | 19.00 | .650 | 16.51 | .748 | 19.00 | .483 | 12.27 | 1.350 | 34.29 | 1.090 | 27.69 | .830 | 21.08 |
| 31 | 1.400 | 35.56 | .370 | 9.40 | 1.115 | 28.32 | 1.150 | 29.21 | .980 | 24.89 | .710 | 18.03 | .756 | 19.20 | .710 | 18.03 | .756 | 19.20 | .476 | 12.09 | 1.420 | 36.07 | 1.130 | 28.70 | .890 | 22.61 |
| 37 | 1.550 | 39.37 | .370 | 9.40 | 1.265 | 32.13 | 1.190 | 30.23 | 1.130 | 28.70 | .750 | 19.05 | .774 | 19.66 | .750 | 19.05 | .774 | 19.66 | .478 | 12.14 | 1.450 | 36.83 | 1.230 | 31.24 | .955 | 24.26 |
| 51 | 1.500 | 38.10 | .410 | 10.41 | 1.215 | 30.86 | 1.220 | 30.99 | 1.080 | 27.43 | .780 | 19.81 | .859 | 21.82 | .780 | 19.81 | .859 | 21.82 | .548 | 13.91 | 1.480 | 37.59 | 1.250 | 31.75 | 1.005 | 25.53 |
| 51-2 | 1.910 | 48.51 | .370 | 9.40 | 1.615 | 41.02 | 1.220 | 30.99 | 1.510 | 38.35 | .780 | 19.81 | .859 | 21.82 | .780 | 19.81 | .859 | 21.82 | .548 | 13.91 | 1.480 | 37.59 | 1.250 | 31.75 | 1.005 | 25.53 |
| 67 | 2.310 | 58.67 | .370 | 9.40 | 2.015 | 51.18 | 1.220 | 30.99 | 1.880 | 47.75 | .780 | 19.81 | .859 | 21.82 | .780 | 19.81 | .859 | 21.82 | .548 | 13.91 | 1.480 | 37.59 | 1.250 | 31.75 | 1.005 | 25.53 |
| 69 | 1.810 | 45.97 | .410 | 10.41 | 1.515 | 38.48 | 1.220 | 30.99 | 1.380 | 35.05 | .780 | 19.81 | .859 | 21.82 | .780 | 19.81 | .859 | 21.82 | .548 | 13.91 | 1.480 | 37.59 | 1.250 | 31.75 | 1.005 | 25.53 |
| 100 | 2.235 | 56.77 | .460 | 11.68 | 1.800 | 45.72 | 1.280 | 32.51 | 1.470 | 37.34 | .840 | 21.34 | 1.014 | 25.76 | .840 | 21.34 | 1.014 | 25.76 | .687 | 17.45 | 1.580 | 40.13 | 1.320 | 33.53 | 1.080 | 27.43 |



507-142 EMI/RFI Dual Entry Banding Backshell Round Cable Entry



Dual Cable Entry EMI backshell allows attachment of two separate wire bundles to the same Micro-D connector. This backshell accepts both standard and micro shield termination straps.

Materials

- Shell: Aluminum Alloy 6061 -T6
- Clips: 17-7PH Stainless Steel
- Hardware: 300 Series Stainless Steel

| How To Order EMI/RFI Dual Entry Backshell | | | | | |
|---|---|--|--|---|---|
| Sample Part Number | 507-142 | M | 25 | H | B |
| Series | 507-142 | | | | |
| Shell Finish | E – Chem Film (Alodyne) M – Electroless Nickel | J – Cadmium, Yellow Chromate NF – Cadmium, Olive Drab | Z2 – Gold | | |
| Connector Size | 21, 25, 31, 37, 51, 51-2, 67, 69, 100 (See Table I) | | | | |
| Hardware Option | B – Fillister Head Jackscrew E – Extended Jackscrew | H – Hex Head Jackscrew F – Jackpost, Female | | | |
| EMI Band Strap Option | Omit (Leave Blank) – Band Not Included B – Standard Band (2 supplied) .250" Wide | | M – Micro Band (2 supplied) .125" Wide | | |

Table I: Dimensions



| Size | A Max. | | B Max. | | C | | D Max. | | E Max. | | F | | G | | H Max. | |
|------|--------|-------|--------|-------|-------|-------|--------|-------|--------|-------|------|-------|------|-------|--------|-------|
| | In. | mm. | In. | mm. | In. | mm. | In. | mm. | In. | mm. | In. | mm. | In. | mm. | In. | mm. |
| 21 | 1.150 | 29.21 | .370 | 9.40 | .865 | 21.97 | 1.030 | 26.16 | .740 | 18.80 | .125 | 3.18 | .281 | 7.13 | .590 | 14.99 |
| 25 | 1.250 | 31.75 | .370 | 9.40 | .965 | 24.51 | 1.090 | 27.69 | .850 | 21.59 | .188 | 4.78 | .344 | 8.74 | .650 | 16.51 |
| 31 | 1.400 | 35.56 | .370 | 9.40 | 1.115 | 28.32 | 1.150 | 29.21 | .980 | 24.89 | .250 | 6.35 | .406 | 10.31 | .710 | 18.03 |
| 37 | 1.550 | 39.37 | .370 | 9.40 | 1.265 | 32.13 | 1.190 | 30.23 | 1.130 | 28.70 | .344 | 8.74 | .500 | 12.70 | .750 | 19.05 |
| 51 | 1.500 | 38.10 | .410 | 10.41 | 1.215 | 30.86 | 2.130 | 54.10 | 1.080 | 27.43 | .312 | 7.92 | .469 | 11.91 | .780 | 19.81 |
| 51-2 | 1.910 | 48.51 | .370 | 9.40 | 1.615 | 41.02 | 2.130 | 54.10 | 1.510 | 38.35 | .281 | 7.13 | .469 | 11.91 | .780 | 19.81 |
| 67 | 2.310 | 58.67 | .370 | 9.40 | 2.015 | 51.18 | 2.130 | 54.10 | 1.880 | 47.75 | .281 | 7.13 | .469 | 11.91 | .780 | 19.81 |
| 69 | 1.810 | 45.97 | .410 | 10.41 | 1.515 | 38.48 | 2.130 | 54.10 | 1.380 | 35.05 | .312 | 7.93 | .469 | 11.91 | .780 | 19.81 |
| 100 | 2.235 | 56.77 | .460 | 11.68 | 1.800 | 45.72 | 1.280 | 32.51 | 1.470 | 37.34 | .500 | 12.70 | .688 | 17.48 | .840 | 21.34 |

M

507-145 EMI/RFI Split Shell Banding Backshell with Screwlocks Round Cable Entry



Split EMI Backshells allow installation on wired connector assemblies.

Captive Screwlocks for fast connection. Plug in the connector, then fasten the hardware.

Materials

- Shell: Aluminum Alloy 6061 -T6
- Clips: 17-7PH Stainless Steel
- Hardware: 300 Series Stainless Steel

| How To Order EMI/RFI Split Banding Backshell | | | | | |
|--|--|--|-----------|----|-----|
| Sample Part Number | 507-145 | | M | 25 | H B |
| Series | 507-145 | | | | |
| Shell Finish | E – Chem Film (Alodyne) M – Electroless Nickel | J – Cadmium, Yellow Chromate NF – Cadmium, Olive Drab | Z2 – Gold | | |
| Connector Size | 09, 15, 21, 25, 31, 37 51, 51-2, 67, 69, 100 (See Table I) | | | | |
| Hardware Option | OMIT – For Fillister Head Screwlock E – Extended Screwlock | H – Hex Head Screwlock F – Jackpost, Female | | | |
| EMI Band Strap Option | Omit (Leave Blank) – Band Not Included B – Micro Band Supplied K – Coiled Micro Band Supplied | | | | |

Table I: Dimensions



| Size | A Max. | | B Max. | | C | | D | | E Max. | | F Max. | | G Max. | |
|------|--------|-------|--------|-------|-------|-------|---------------|---------------|--------|-------|--------|-------|--------|-------|
| | In. | mm. | In. | mm. | In. | mm. | In. ± .010 | mm. ± 0.25 | In. | mm. | In. | mm. | In. | mm. |
| 09 | .915 | 23.24 | .450 | 11.43 | .565 | 14.35 | .160 | 4.06 | 1.033 | 26.24 | .721 | 18.31 | .554 | 14.07 |
| 15 | 1.065 | 27.05 | .450 | 11.43 | .715 | 18.16 | .190 | 4.83 | 1.096 | 27.84 | .783 | 19.89 | .617 | 15.67 |
| 21 | 1.215 | 30.86 | .450 | 11.43 | .865 | 21.97 | .220 | 5.59 | 1.127 | 28.63 | .815 | 20.70 | .649 | 16.48 |
| 25 | 1.315 | 33.40 | .450 | 11.43 | .965 | 24.51 | .260 | 6.60 | 1.190 | 30.23 | .877 | 22.28 | .711 | 18.06 |
| 31 | 1.465 | 37.21 | .450 | 11.43 | 1.115 | 28.32 | .275 | 6.99 | 1.221 | 31.01 | .908 | 23.06 | .722 | 18.34 |
| 37 | 1.615 | 41.02 | .450 | 11.43 | 1.265 | 32.13 | .285 | 7.24 | 1.283 | 32.59 | .971 | 24.66 | .785 | 19.94 |
| 51 | 1.565 | 39.75 | .495 | 12.57 | 1.215 | 30.86 | .350 | 8.89 | 1.346 | 34.19 | 1.033 | 26.24 | .867 | 22.02 |
| 51-2 | 1.965 | 48.91 | .450 | 11.43 | 1.615 | 41.02 | .285 | 7.24 | 1.346 | 34.19 | 1.033 | 26.24 | .867 | 22.02 |
| 67 | 2.365 | 60.07 | .450 | 11.43 | 2.015 | 51.18 | .350 | 8.89 | 1.346 | 34.19 | 1.033 | 26.24 | .867 | 22.02 |
| 69 | 1.865 | 47.37 | .495 | 12.57 | 1.515 | 38.48 | .350 | 8.89 | 1.346 | 34.19 | 1.033 | 26.24 | .867 | 22.02 |
| 100 | 2.305 | 58.55 | .540 | 13.72 | 1.800 | 45.72 | .490 | 12.45 | 1.408 | 35.76 | 1.096 | 27.83 | .930 | 23.62 |





500-011 EMI/RFI Shield Sock Backshell Round Cable Entry



Shield Sock Backshells save assembly time. These backshells are terminated to tinned copper braid in whatever length you require.

Available in Top, 45° and Side Entry, these backshells feature one piece construction and are available in a variety of plating finishes.

Precision Swaged Braid Termination adds mechanical strength and lowers resistance compared to hex crimps.

How To Order Shield Sock EMI/RFI Backshells

| | | | | | | | | |
|---------------------------|---|--|---|------------------------|------------------------|----------|-----------|------------|
| Sample Part Number | 500T011 | | | M | 25 | H | 08 | -12 |
| Series | 500T011 - Top Entry (See Table I) | 500S011 - Side Entry | 500E011 - 45° Entry | | | | | |
| Shell Finish | E - Chem Film (Alodyne) M - Electroless Nickel | J - Cadmium, Yellow Chromate NF - Cadmium, Olive Drab | Z2 - Gold | | | | | |
| Connector Size | 09, 15, 21, 25, 31, 37, 51, 51-2, 67, 69, 100 (See Table III) | | | | | | | |
| Hardware Option | B - Fillister Head Jackscrew E - Extended Jackscrew | | H - Hex Head Jackscrew F - Jackpost, Female (See Table II) | | | | | |
| Cable Entry Code | 04 - .125 (3.2) | 05 - .156 (4.0) | 06 - .188 (4.8) | 07 - .219 (5.6) | 12 - .375 (9.5) | | | |
| | 08 - .250 (6.4) | 09 - .281 (7.1) | 10 - .312 (7.9) | 11 - .344 (8.7) | | | | |
| | Maximum Cable Entry Diameter per Shell Size and Style | | | | | | | |
| | Size | T Top Entry | E 45° Entry | S Side Entry | | | | |
| | 9 | 08 | 08 | 09 | | | | |
| | 15 | 08 | 08 | 12 | | | | |
| | 21 | 08 | 08 | 12 | | | | |
| | 25 | 08 | 08 | 12 | | | | |
| | 31 | 09 | 09 | 12 | | | | |
| | 37 | 09 | 09 | 12 | | | | |
| 51 | 10 | 10 | 12 | | | | | |
| 51-2 | 09 | 09 | 12 | | | | | |
| 67 | 09 | 09 | 12 | | | | | |
| 69 | 10 | 10 | 12 | | | | | |
| 100 | 12 | 12 | 12 | | | | | |
| Length of Braid | Length in One Inch Increments - Example: " 12 " equals twelve inches. | | | | | | | |

Table I: Entry Styles



Material and Finish

- Shell: Aluminum Alloy 6061 -T6 Per QQ-A-200, QQ-A-225 (Machined Components)
Aluminum Alloy 6061-T6 Per QQ-A-591 (A380) (Die-Cast Components)
- Braid: Tinned Copper Braid Per QQ-B-575 ASTM B33, #36 AWG Strands, 90% Coverage
- Crimp Ring: Copper, Tin Plated
- Clips, E-Rings: 17-7PH Stainless Steel
- Jackscrews, Washers, Jackposts: 300 Series Stainless Steel, Passivated

500-011 EMI/RFI Shield Sock Backshell Round Cable Entry



Table II: Hardware Options

| | | | |
|-------------------------------------|-------------------------------|--|-----------------------------|
| | | | |
| B - Fillister Head Jackscrew | H - Hex Head Jackscrew | E - Extended Jackscrew (Not for 45° Entry) | F - Jackpost, Female |

Table III: Dimensions



Table IV: Cable Entry Code

| Cable Entry Code | F | | G Max. | |
|------------------|------------|------------|--------|-------|
| | In. ± .010 | mm. ± 0.25 | In. | mm. |
| 04 | .125 | 3.18 | .310 | 7.87 |
| 05 | .156 | 3.96 | .350 | 8.89 |
| 06 | .188 | 4.78 | .380 | 9.65 |
| 07 | .219 | 5.56 | .400 | 10.16 |
| 08 | .250 | 6.35 | .425 | 13.31 |
| 09 | .281 | 7.14 | .450 | 11.43 |
| 10 | .312 | 7.92 | .500 | 12.70 |
| 11 | .344 | 8.74 | .525 | 13.34 |
| 12 | .375 | 9.53 | .550 | 13.97 |

| Size | A Max. | | B Max. | | C | | D Max. | | E Max. | | H Max. | | J Max. | | K | | L Max. | | M Max. | | N Max. | |
|------|--------|-------|--------|-------|-------|-------|--------|-------|--------|-------|--------|-------|--------|-------|------|-------|--------|-------|--------|-------|--------|-------|
| | In. | mm. | In. | mm. | In. | mm. | In. | mm. | In. | mm. | In. | mm. | In. | mm. | In. | mm. | In. | mm. | In. | mm. | In. | mm. |
| 09 | .850 | 21.59 | .370 | 9.40 | .565 | 14.35 | .780 | 19.81 | .410 | 10.41 | .350 | 8.89 | .637 | 16.18 | .435 | 11.05 | 1.040 | 26.42 | 1.000 | 25.40 | .680 | 17.27 |
| 15 | 1.000 | 25.40 | .370 | 9.40 | .715 | 18.16 | .910 | 23.11 | .580 | 14.73 | .470 | 11.94 | .673 | 17.09 | .440 | 11.20 | 1.170 | 29.72 | 1.030 | 26.16 | .730 | 18.54 |
| 21 | 1.150 | 29.21 | .370 | 9.40 | .865 | 21.97 | 1.030 | 26.16 | .740 | 18.80 | .590 | 14.99 | .707 | 17.95 | .458 | 11.63 | 1.290 | 32.77 | 1.050 | 26.67 | .765 | 19.43 |
| 25 | 1.250 | 31.75 | .370 | 9.40 | .965 | 24.51 | 1.090 | 27.69 | .850 | 21.59 | .650 | 16.51 | .748 | 19.00 | .483 | 12.27 | 1.350 | 34.29 | 1.090 | 27.69 | .830 | 21.08 |
| 31 | 1.400 | 35.56 | .370 | 9.40 | 1.115 | 28.32 | 1.150 | 29.21 | .980 | 24.89 | .710 | 18.03 | .756 | 19.20 | .476 | 12.09 | 1.420 | 36.07 | 1.130 | 28.70 | .890 | 22.61 |
| 37 | 1.550 | 39.37 | .370 | 9.40 | 1.265 | 32.13 | 1.190 | 30.23 | 1.130 | 28.70 | .750 | 19.05 | .774 | 19.66 | .478 | 12.14 | 1.450 | 36.83 | 1.230 | 31.24 | .955 | 24.26 |
| 51 | 1.500 | 38.10 | .410 | 10.41 | 1.215 | 30.86 | 1.220 | 30.99 | 1.080 | 27.43 | .780 | 19.81 | .859 | 21.82 | .548 | 13.91 | 1.480 | 37.59 | 1.250 | 31.75 | 1.005 | 25.53 |
| 51-2 | 1.910 | 48.51 | .370 | 9.40 | 1.615 | 41.02 | 1.220 | 30.99 | 1.510 | 38.35 | .780 | 19.81 | .859 | 21.82 | .548 | 13.91 | 1.480 | 37.59 | 1.250 | 31.75 | 1.005 | 25.53 |
| 67 | 2.310 | 58.67 | .370 | 9.40 | 2.015 | 51.18 | 1.220 | 30.99 | 1.880 | 47.75 | .780 | 19.81 | .859 | 21.82 | .548 | 13.91 | 1.480 | 37.59 | 1.250 | 31.75 | 1.005 | 25.53 |
| 69 | 1.810 | 45.97 | .410 | 10.41 | 1.515 | 38.48 | 1.220 | 30.99 | 1.380 | 35.05 | .780 | 19.81 | .859 | 21.82 | .548 | 13.91 | 1.480 | 37.59 | 1.250 | 31.75 | 1.005 | 25.53 |
| 100 | 2.235 | 56.77 | .460 | 11.68 | 1.800 | 45.72 | 1.280 | 32.51 | 1.470 | 37.34 | .840 | 21.34 | 1.014 | 25.76 | .687 | 17.45 | 1.580 | 40.13 | 1.320 | 33.53 | 1.080 | 27.43 |





507-088 Composite EMI/RFI Banding Backshell Round Cable Entry



Save Weight and Eliminate Corrosion Damage with composite Micro-D backshells. These round cable entry backshells are injection-molded with high strength Ultem 2300 fiberglass-reinforced thermoplastic.

Choose Top, Side or 45° Cable Entry.

Electroless Nickel Plated for excellent EMI shielding effectiveness.

| How To Order EMI/RFI Banding Backshells | | | | | | | | | | | | | | | | | | | | | | | | | | | | | | | | | | | | | | | | | |
|---|--|--|--|----|------|-------------|-------------|--------------|--------------|---|----|----|----|----|----|----|----|----|----|----|----|----|----|----|----|----|----|----|----|----|----|----|----|----|----|----|----|-----|----|----|----|
| Sample Part Number | 507T088 | | XM | 25 | H 08 | | | | | | | | | | | | | | | | | | | | | | | | | | | | | | | | | | | | |
| Series | 507T088 - Top Entry 507S088 - Side Entry 507E088 - 45° Entry (See Table II) | | | | | | | | | | | | | | | | | | | | | | | | | | | | | | | | | | | | | | | | |
| Shell Finish | XM - Electroless Nickel | | | | | | | | | | | | | | | | | | | | | | | | | | | | | | | | | | | | | | | | |
| Connector Size | 09, 15, 21, 25, 31, 37 51, 100 (See Table III) | | | | | | | | | | | | | | | | | | | | | | | | | | | | | | | | | | | | | | | | |
| Hardware Option | B - Fillister Head Jackscrew E - Extended Jackscrew (Not Available for 45° Cable Entry) | | H - Hex Head Jackscrew F - Jackpost, Female (See Table I) | | | | | | | | | | | | | | | | | | | | | | | | | | | | | | | | | | | | | | |
| Cable Entry Code | 04 - .125 (3.2) | Maximum Cable Entry Per Entry Style and Shell Size Selections <table border="1"> <thead> <tr> <th>Size</th> <th>T Top Entry</th> <th>E 45° Entry</th> <th>S Side Entry</th> </tr> </thead> <tbody> <tr><td>9</td><td>08</td><td>08</td><td>09</td></tr> <tr><td>15</td><td>08</td><td>08</td><td>12</td></tr> <tr><td>21</td><td>08</td><td>08</td><td>12</td></tr> <tr><td>25</td><td>08</td><td>08</td><td>12</td></tr> <tr><td>31</td><td>09</td><td>09</td><td>12</td></tr> <tr><td>37</td><td>09</td><td>09</td><td>12</td></tr> <tr><td>51</td><td>10</td><td>10</td><td>12</td></tr> <tr><td>100</td><td>12</td><td>12</td><td>12</td></tr> </tbody> </table> | | | | Size | T Top Entry | E 45° Entry | S Side Entry | 9 | 08 | 08 | 09 | 15 | 08 | 08 | 12 | 21 | 08 | 08 | 12 | 25 | 08 | 08 | 12 | 31 | 09 | 09 | 12 | 37 | 09 | 09 | 12 | 51 | 10 | 10 | 12 | 100 | 12 | 12 | 12 |
| | Size | | | | | T Top Entry | E 45° Entry | S Side Entry | | | | | | | | | | | | | | | | | | | | | | | | | | | | | | | | | |
| | 9 | | | | | 08 | 08 | 09 | | | | | | | | | | | | | | | | | | | | | | | | | | | | | | | | | |
| | 15 | | | | | 08 | 08 | 12 | | | | | | | | | | | | | | | | | | | | | | | | | | | | | | | | | |
| | 21 | | | | | 08 | 08 | 12 | | | | | | | | | | | | | | | | | | | | | | | | | | | | | | | | | |
| | 25 | | | | | 08 | 08 | 12 | | | | | | | | | | | | | | | | | | | | | | | | | | | | | | | | | |
| | 31 | | | | | 09 | 09 | 12 | | | | | | | | | | | | | | | | | | | | | | | | | | | | | | | | | |
| | 37 | | | | | 09 | 09 | 12 | | | | | | | | | | | | | | | | | | | | | | | | | | | | | | | | | |
| | 51 | | | | | 10 | 10 | 12 | | | | | | | | | | | | | | | | | | | | | | | | | | | | | | | | | |
| | 100 | | | | | 12 | 12 | 12 | | | | | | | | | | | | | | | | | | | | | | | | | | | | | | | | | |
| 05 - .156 (4.0) | | | | | | | | | | | | | | | | | | | | | | | | | | | | | | | | | | | | | | | | | |
| 06 - .188 (4.8) | | | | | | | | | | | | | | | | | | | | | | | | | | | | | | | | | | | | | | | | | |
| 07 - .219 (5.6) | | | | | | | | | | | | | | | | | | | | | | | | | | | | | | | | | | | | | | | | | |
| 08 - .250 (6.4) | | | | | | | | | | | | | | | | | | | | | | | | | | | | | | | | | | | | | | | | | |
| 09 - .281 (7.1) | | | | | | | | | | | | | | | | | | | | | | | | | | | | | | | | | | | | | | | | | |
| 10 - .312 (7.9) | | | | | | | | | | | | | | | | | | | | | | | | | | | | | | | | | | | | | | | | | |
| 11 - .344 (8.7) | | | | | | | | | | | | | | | | | | | | | | | | | | | | | | | | | | | | | | | | | |
| 12 - .375 (9.5) | | | | | | | | | | | | | | | | | | | | | | | | | | | | | | | | | | | | | | | | | |
| | (See Table IV) | | | | | | | | | | | | | | | | | | | | | | | | | | | | | | | | | | | | | | | | |

Table I: Hardware Option



| | | | |
|---|---|--|---|
|  |  |  |  |
| B - Fillister Head Jackscrew | H - Hex Head Jackscrew | E - Extended Jackscrew (Not for 45° Entry) | F - Jackpost, Female |

Table II: Entry Styles

| 507T088 Top Entry | 507S088 Side Entry | 507E088 45° Entry |
|---|---|---|
|  |  |  |

Materials

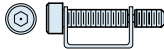
- Shell: Ultem 2300
- Clips: 17-7PH Stainless Steel
- Hardware: 300 Series Stainless Steel

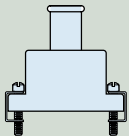
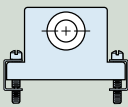
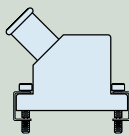
507-088 Composite EMI/RFI Banding Backshell Round Cable Entry



Table III: Dimensions



Table IV: Cable Entry Codes

| Cable Entry Code | F | | G | |
|------------------|-----------|-----------|------|-------|
| | In. ±.010 | mm. ±0.25 | In. | mm. |
| 04 | .125 | 3.18 | .219 | 5.56 |
| 05 | .156 | 3.96 | .250 | 6.35 |
| 06 | .188 | 4.78 | .281 | 7.14 |
| 07 | .219 | 5.56 | .313 | 7.95 |
| 08 | .250 | 6.35 | .344 | 8.74 |
| 09 | .281 | 7.14 | .375 | 9.53 |
| 10 | .312 | 7.92 | .406 | 10.31 |
| 11 | .344 | 8.74 | .438 | 11.13 |
| 12 | .375 | 9.53 | .469 | 11.92 |

| Size | A Max. | | B Max. | | C | | D Max. | | E Max. | | H Max. | | J Max. | | K | | L Max. | | M Max. | | N Max. | |
|------|--------|-------|--------|-------|-------|-------|--------|-------|--------|-------|--------|-------|--------|-------|------|-------|--------|-------|--------|-------|--------|-------|
| | In. | mm. | In. | mm. | In. | mm. | In. | mm. | In. | mm. | In. | mm. | In. | mm. | In. | mm. | In. | mm. | In. | mm. | In. | mm. |
| 09 | .850 | 21.59 | .370 | 9.40 | .565 | 14.35 | .780 | 19.81 | .410 | 10.41 | .460 | 8.89 | .680 | 17.27 | .435 | 11.05 | 1.040 | 26.42 | 1.000 | 25.40 | .680 | 17.27 |
| 15 | 1.000 | 25.40 | .370 | 9.40 | .715 | 18.16 | .790 | 20.07 | .580 | 14.73 | .470 | 11.94 | .730 | 18.54 | .440 | 11.2 | 1.170 | 29.72 | 1.030 | 26.16 | .730 | 18.54 |
| 21 | 1.150 | 29.21 | .370 | 9.40 | .865 | 21.97 | .910 | 23.11 | .740 | 18.80 | .590 | 14.99 | .765 | 19.43 | .458 | 11.63 | 1.290 | 32.77 | 1.050 | 26.67 | .765 | 19.43 |
| 25 | 1.250 | 31.75 | .370 | 9.40 | .965 | 24.51 | .970 | 24.64 | .850 | 21.59 | .650 | 16.51 | .830 | 21.08 | .483 | 12.27 | 1.350 | 34.29 | 1.090 | 27.69 | .830 | 21.08 |
| 31 | 1.400 | 35.56 | .370 | 9.40 | 1.115 | 28.32 | 1.030 | 26.16 | .980 | 24.89 | .710 | 18.03 | .890 | 20.32 | .476 | 12.09 | 1.420 | 36.07 | 1.130 | 28.70 | .890 | 22.61 |
| 37 | 1.550 | 39.37 | .370 | 9.40 | 1.265 | 32.13 | 1.070 | 27.18 | 1.130 | 28.70 | .750 | 19.05 | .955 | 24.26 | .478 | 12.14 | 1.450 | 36.83 | 1.230 | 31.24 | .955 | 24.26 |
| 51 | 1.500 | 38.10 | .410 | 10.41 | 1.215 | 30.86 | 1.100 | 27.94 | 1.080 | 27.43 | .780 | 19.81 | 1.005 | 25.53 | .548 | 13.91 | 1.480 | 37.59 | 1.250 | 31.75 | 1.005 | 25.53 |
| 100 | 2.235 | 56.77 | .460 | 11.68 | 1.800 | 45.72 | 1.160 | 29.46 | 1.470 | 37.34 | .810 | 21.34 | 1.080 | 27.43 | .687 | 17.45 | 1.580 | 40.13 | 1.320 | 33.53 | 1.080 | 27.43 |





500-047 EMI/RFI Elliptical Banding Backshell



Elliptical Backshells provide extra room for large wire bundles. This one piece version features an oversize shield termination area for both standard and micro BandMaster™ ATS shield termination straps.

Materials

- Shell: Aluminum Alloy
- Clips: 17-7PH Stainless Steel
- Hardware: 300 Series Stainless Steel

How To Order EMI/RFI Elliptical Backshells

| | | | | | |
|------------------------------|---|--|------------------|----------|----------|
| Sample Part Number | 500-047 | M | 25 | H | T |
| Series | 500-047 | | | | |
| Shell Finish | E – Chem Film (Alodyne) M – Electroless Nickel | J – Cadmium, Yellow Chromate NF – Cadmium, Olive Drab | Z2 – Gold | | |
| Connector Size | 09, 15, 21, 25, 31, 37 51, 51-2, 67, 69, 100 (See Table I) | | | | |
| Hardware Option | B – Fillister Head Jackscrew E – Extended Jackscrew | H – Hex Head Jackscrew F – Jackpost, Female | (See Table I) | | |
| EMI Band Strap Option | Omit (Leave Blank) – Band Not Included B – Standard Band .250" Wide, uncoiled M – Micro Band .125" Wide, uncoiled | | | | |
| Qwik-Ty Option | T – with Qwik-Ty Omit for none | | | | |

Table I: Dimensions



| Hardware Option |
|-------------------------------------|
| B - Fillister Head Jackscrew |
| H - Hex Head Jackscrew |
| E - Extended Jackscrew |
| F - Jackpost, Female |

| Size | A | | B | | C | | D Dia | | E Dia | | F | | G | | H Ref. | | J Thread |
|-------------|-------|-------|-----|-------|------|-------|-------|-------|-------|------|-----|-------|-------|-------|--------|------|-------------|
| | In. | mm. | In. | mm. | In. | mm. | In. | mm. | In. | mm. | In. | mm. | In. | mm. | In. | mm. | |
| 09 | .775 | 19.69 | .34 | 8.64 | .75 | 19.05 | .312 | 7.92 | .281 | 7.14 | .32 | 8.13 | .565 | 14.35 | .154 | 3.91 | 2-56 UNC-2A |
| 15 | .925 | 23.50 | .34 | 8.64 | .88 | 22.35 | .420 | 10.67 | .281 | 7.14 | .44 | 11.18 | .715 | 18.16 | .154 | 3.91 | 2-56 UNC-2A |
| 21 | 1.075 | 27.31 | .34 | 8.64 | 1.00 | 25.40 | .590 | 14.99 | .281 | 7.14 | .56 | 14.22 | .865 | 21.97 | .154 | 3.91 | 2-56 UNC-2A |
| 25 | 1.175 | 29.85 | .34 | 8.64 | 1.06 | 26.92 | .690 | 17.53 | .281 | 7.14 | .62 | 15.75 | .965 | 24.51 | .154 | 3.91 | 2-56 UNC-2A |
| 31 | 1.325 | 33.66 | .34 | 8.64 | 1.12 | 28.45 | .820 | 20.83 | .281 | 7.14 | .68 | 17.27 | 1.115 | 28.32 | .154 | 3.91 | 2-56 UNC-2A |
| 37 | 1.475 | 37.47 | .34 | 8.64 | 1.16 | 29.46 | .970 | 24.64 | .281 | 7.14 | .72 | 18.29 | 1.265 | 32.13 | .154 | 3.91 | 2-56 UNC-2A |
| 51 | 1.425 | 36.20 | .38 | 9.65 | 1.19 | 30.23 | .920 | 23.37 | .312 | 7.92 | .75 | 19.05 | 1.215 | 30.86 | .154 | 3.91 | 2-56 UNC-2A |
| 51-2 | 1.835 | 46.61 | .34 | 8.64 | 1.19 | 30.23 | 1.030 | 26.16 | .281 | 7.14 | .75 | 19.05 | 1.615 | 41.02 | .154 | 3.91 | 2-56 UNC-2A |
| 69 | 1.730 | 43.94 | .40 | 10.16 | 1.19 | 30.23 | 1.190 | 30.23 | .312 | 7.92 | .75 | 19.05 | 1.515 | 38.48 | .154 | 3.91 | 2-56 UNC-2A |
| 100 | 2.160 | 54.86 | .43 | 10.92 | 1.25 | 31.75 | 1.290 | 32.77 | .360 | 9.14 | .81 | 20.57 | 1.800 | 45.72 | .184 | 4.67 | 4-40 UNC-2A |



507-175
Straight, Top, and 45° Entry EMI/RFI
Elliptical Banding Backshell



17-7PH Stainless Steel Clips attach the backshell to the connector. These backshells accept standard and micro BandMaster™ ATS shield termination straps.

Straight, 45° and Right Angle elliptical backshell provides plenty of working room for complicated wiring situations.

Rugged One-Piece Aluminum Shell with stainless steel hardware, available in standard nickel plating, or choose optional finishes.

| How To Order EMI/RFI Elliptical Backshells | | | | |
|--|---|--|---|--|
| Sample Part Number | 507E175 M 25 04 | | | |
| Series | 507T175 - Top Entry 507S175 - Side Entry 507E175 - 45° Side Entry (See Table I) | | | |
| Shell Finish | E – Chem Film (Alodyne) M – Electroless Nickel | J – Cadmium, Yellow Chromate NF – Cadmium, Olive Drab | Z2 – Gold | |
| Connector Size | 09, 15, 21, 25, 31, 37 51, 51-2, 67, 69, 100 (See Table III) | | | |
| Cable Entry Code | 01, 02, 03, 04, 05, 06, 07, 08 (See Table IV) | | | |
| Hardware Option | OMIT (Leave Blank) – Fillister Head Jackscrew E – Extended Jackscrew | | H – Hex Head Jackscrew F – Jackpost, Female (See Table II) | |

| Table I: Entry Styles | | |
|-----------------------|-----------------------|----------------------|
| 507T175 Top Entry | 507S175 Side Entry | 507E175 45° Entry |
| | | |

Materials

(See Ordering Info For Finish Options)

- Shell: Aluminum Alloy 6061 -T6 Per QQ-A-200, QQ-A-225 (Machined Components)
- Aluminum Alloy 6061-T6 Per QQ-A-591 (A380) (Die-Cast Components)
- Clips: 17-7PH Stainless Steel
- Jackscrews, Washers, Jackposts: 300 Series Stainless Steel, Passivated

| Table II: Hardware Option | | | |
|------------------------------|------------------------|---|----------------------|
| | | | |
| B - Fillister Head Jackscrew | H - Hex Head Jackscrew | E - Extended Jackscrew (Not for 45° Entry) | F - Jackpost, Female |





507-175

Straight, Top, and 45° Entry EMI/RFI Elliptical Banding Backshell

Table III: Dimensions



Table IV: Cable Entry Sizes

| Cable Entry Code | D | | E | | Available on Shell Size |
|------------------|-----------|-----------|-----------|-----------|-------------------------|
| | In. ±.010 | mm. ±0.25 | In. ±.010 | mm. ±0.25 | |
| 01 | .344 | 8.74 | .290 | 7.37 | 09 Thru 100 |
| 02 | .494 | 12.55 | .290 | 7.37 | 15 Thru 100 |
| 03 | .644 | 16.36 | .290 | 7.37 | 21 Thru 100 |
| 04 | .744 | 18.90 | .304 | 7.72 | 25 Thru 100 |
| 05 | .894 | 21.34 | .304 | 7.72 | 31 Thru 100 |
| 06 | .994 | 25.25 | .304 | 7.72 | 37 Thru 100 |
| 07 | 1.044 | 26.52 | .304 | 7.72 | 37 and 100 |
| 08 | 1.024 | 26.01 | .384 | 9.75 | 100 |



| Size | A Max. | | B Max. | | C | | F Max. | | G Max. | | H Max. | | J Max. | | K Max. | |
|------|--------|-------|--------|-------|-------|-------|--------|-------|--------|-------|--------|-------|--------|-------|--------|-------|
| | In. | mm. | In. | mm. | In. | mm. | In. | mm. | In. | mm. | In. | mm. | In. | mm. | In. | mm. |
| 09 | .850 | 21.59 | .370 | 9.40 | .565 | 14.35 | .782 | 19.86 | .970 | 24.64 | .668 | 16.97 | .673 | 17.09 | .851 | 21.62 |
| 15 | 1.000 | 25.40 | .370 | 9.40 | .715 | 18.16 | .832 | 21.13 | .970 | 24.64 | .668 | 16.97 | .673 | 17.09 | .876 | 22.25 |
| 21 | 1.150 | 29.21 | .370 | 9.40 | .865 | 21.97 | .882 | 22.40 | .970 | 24.64 | .668 | 16.97 | .673 | 17.09 | .901 | 22.89 |
| 25 | 1.250 | 31.75 | .370 | 9.40 | .965 | 24.51 | .932 | 23.67 | .990 | 25.15 | .678 | 17.22 | .700 | 17.78 | .943 | 23.95 |
| 31 | 1.400 | 35.56 | .370 | 9.40 | 1.115 | 28.32 | .972 | 24.69 | .990 | 25.15 | .678 | 17.22 | .700 | 17.78 | .963 | 24.46 |
| 37 | 1.550 | 39.37 | .370 | 9.40 | 1.265 | 32.13 | .972 | 24.69 | .990 | 25.15 | .678 | 17.22 | .700 | 17.78 | .983 | 24.97 |
| 51 | 1.500 | 38.10 | .410 | 10.41 | 1.215 | 30.86 | 1.092 | 27.74 | 1.030 | 26.16 | .698 | 17.73 | .758 | 19.25 | 1.050 | 26.67 |
| 51-2 | 1.910 | 48.51 | .370 | 9.40 | 1.615 | 41.02 | 1.092 | 27.74 | 1.030 | 26.16 | .698 | 17.73 | .758 | 19.25 | 1.050 | 26.67 |
| 67 | 2.310 | 58.67 | .370 | 9.40 | 2.015 | 51.18 | 1.092 | 27.74 | 1.030 | 26.16 | .698 | 17.73 | .758 | 19.25 | 1.050 | 26.67 |
| 69 | 1.810 | 45.97 | .410 | 10.41 | 1.515 | 38.48 | 1.092 | 27.74 | 1.030 | 26.16 | .698 | 17.73 | .758 | 19.25 | 1.050 | 26.67 |
| 100 | 2.235 | 56.77 | .460 | 11.68 | 1.800 | 45.72 | 1.157 | 29.39 | 1.090 | 27.69 | .723 | 18.36 | .824 | 20.93 | 1.130 | 28.70 |

M

507-297
Side Entry EMI/RFI Lightweight Metal Backshell
MIL-DTL-83513



EMI/RFI Lightweight Metal Shell Connectors provide rugged aluminum housing with stainless steel hardware, available in standard nickel plating, or choose optional finishes. Terminate cable shields with BandMaster™ ATS micro bands. This backshell features floating male screwlocks which allow full mating of the connector before the screws are fastened.

| How To Order EMI/RFI Lightweight Backshells | | | | | | |
|---|--|-------------------------------------|-----------------------------------|----------|----------|----------|
| Sample Part Number | 507E297 | M | 25 | D | H | L |
| Series | 507E297 - End Entry Style (45) | | | | | |
| Finish Code | A - Cadmium Plate/Bright Dip B - Cadmium Plate/Olive Drab B1 - Cadmium Plate/Olive Drab Type II Class 1 J - Gold Iridite Over Cadmium Plate Over Nickel M - Electroless Nickel N - Cadmium Plate/Olive Drab Over Nickel NF - Cad/O.D. Over Electroless Nickel (1000 Hour Salt Spray) T - Cadmium Plate/Bright Dip Over Nickel Z2 - Gold Plate | | | | | |
| Shell Size | 09, 15, 21, 25, 31, 37, 51, 51-2, 67, 69, 75, 100 (See Table I) | | | | | |
| Max Entry Code | Max Entry Code | H Ø | Available Sizes | | | |
| | A | .188 | 09 Thru 100 | | | |
| | B | .230 | 15 Thru 100 | | | |
| | C | .265 | 21 Thru 100 | | | |
| | D | .335 | 25 Thru 100 | | | |
| | E | .360 | 31 Thru 100 | | | |
| | F | .410 | 37 Thru 100 | | | |
| | G | .520 | 51 Thru 100 | | | |
| | H | .585 | 51-2 Thru 100 | | | |
| | J | .665 | 67 Thru 100 | | | |
| | K | .720 | 67 and 100 | | | |
| | L | .760 | 67 | | | |
| Hardware Option | B - Fillister Head Jackscrew | H - Socket Head Jackscrew | F - Female Jackpost | | | |
| EMI Band Strap Option | Omit (Blank) - No Band | M - Uncoiled .125" Wide Band | L - Coiled .125" Wide Band | | | |



Notes

1. Assembly Identified With Manufacturer's
2. Name and P/N, Space Permitting.

Material/Finish

- Backshell - al alloy / see Table 2
- Hardware - cres / passivated.
- See 507-296 for straight & 90° configurations.



507-297
EMI/RFI Lightweight Metal Backshell
MIL-DTL-83513

Table I: Dimensions



Hardware Mounting Options



| Size | A | | B | | C | | D | | E | | F | | G | | Max Entry | | |
|------|-------|-------|-------|-------|-------|-------|-------|-------|-------|-------|-------|-------|-------|------|-----------|-------|---|
| | in | mm | in | mm | in | mm | in | mm | in | mm | in | mm | in | mm | | | |
| 09 | 0.775 | 19.69 | 0.340 | 8.64 | 0.565 | 14.35 | 0.500 | 12.70 | 0.700 | 17.78 | 0.440 | 11.18 | - | - | .188 | 4.78 | A |
| 15 | 0.925 | 23.50 | 0.370 | 9.40 | 0.715 | 18.16 | 0.560 | 14.22 | 0.760 | 19.30 | 0.590 | 14.99 | - | - | .230 | 5.84 | B |
| 21 | 1.075 | 27.31 | 0.340 | 8.64 | 0.865 | 21.97 | 0.660 | 16.76 | 0.860 | 21.84 | 0.740 | 18.80 | 0.250 | 6.35 | .265 | 6.73 | C |
| 25 | 1.175 | 29.85 | 0.340 | 8.64 | 0.965 | 24.51 | 0.730 | 18.54 | 0.930 | 23.62 | 0.840 | 21.34 | 0.250 | 6.35 | .335 | 8.51 | D |
| 31 | 1.325 | 33.66 | 0.340 | 8.64 | 1.115 | 28.32 | 0.810 | 20.57 | 1.010 | 25.65 | 0.990 | 25.15 | 0.250 | 6.35 | .360 | 9.14 | E |
| 37 | 1.475 | 37.47 | 0.340 | 8.64 | 1.265 | 32.13 | 0.890 | 22.61 | 1.090 | 27.69 | 1.140 | 28.96 | 0.250 | 6.35 | .410 | 10.41 | F |
| 51 | 1.425 | 36.20 | 0.380 | 9.65 | 1.215 | 30.86 | 0.900 | 22.86 | 1.100 | 27.94 | 1.090 | 27.69 | 0.290 | 7.37 | .520 | 13.21 | G |
| 51-2 | 1.825 | 46.36 | 0.340 | 8.64 | 1.615 | 41.02 | 1.030 | 26.16 | 1.230 | 31.24 | 1.490 | 37.85 | 0.250 | 6.35 | .585 | 14.86 | H |
| 67 | 2.225 | 56.52 | 0.340 | 8.64 | 2.015 | 51.18 | 1.030 | 26.16 | 1.230 | 31.24 | 1.890 | 48.01 | 0.250 | 6.35 | .665 | 16.89 | J |
| 69 | 1.725 | 43.82 | 0.380 | 9.65 | 1.515 | 38.48 | 1.050 | 26.67 | 1.250 | 31.75 | 1.390 | 35.31 | 0.290 | 7.37 | .720 | 18.29 | K |
| 100 | 2.160 | 54.86 | 0.430 | 10.92 | 1.800 | 45.72 | 1.100 | 27.94 | 1.300 | 33.02 | 1.522 | 38.66 | 0.340 | 8.64 | .760 | 19.30 | L |

507-296
EMI/RFI Elliptical Lightweight Metal Backshell
MIL-DTL-83513



EMI/RFI Elliptical Lightweight Metal Shell Backshells provides added room for larger wire bundles. Terminate cable shields with BandMaster™ ATSmicrobands. This backshell features floating male screwlocks which allow full mating of the connector before the screws are fastened.

Rugged Aluminum housing with stainless steel hardware, available in standard nickel plating, or choose optional finishes.

How To Order EMI/RFI Metal Shell Backshells

| | | | | | | |
|------------------------------|--|----------|-------------------------------------|----------|-----------------------------------|----------|
| Sample Part Number | 507T296 | M | 25 | D | H | L |
| Series | 507T296 - Top Entry (Straight) 507S296 - Side Entry (90°) | | | | | |
| Finish Symbol | A - Cadmium Plate/Bright Dip B - Cadmium Plate/Olive Drab B1 - Cadmium Plate/Olive Drab Type II Class 1 J - Gold Iridite Over Cadmium Plate Over Nickel M - Electroless Nickel N - Cadmium Plate/Olive Drab Over Nickel NF - Cad/O.D. Over Electroless Nickel (1000 Hour Salt Spray) T - Cadmium Plate/Bright Dip Over Nickel Z2 - Gold Plate | | | | | |
| Shell Size | 09, 15, 21, 25, 31, 37, 51, 51-2, 67, 69, 75, 100 (See Table I) | | | | | |
| Entry Code | Code | G | Available Sizes | | | |
| | A | 0.320 | 09 Thru 100 | | | |
| | B | 0.470 | 15 Thru 100 | | | |
| | C | 0.620 | 21 Thru 100 | | | |
| | D | 0.720 | 25 Thru 100 | | | |
| | E | 0.870 | 31 Thru 100 | | | |
| | F | 0.970 | 37 Thru 100 | | | |
| | G | 1.020 | 37 & 51-2 Thru 100 | | | |
| | H | 1.270 | 51-2 Thru 100 | | | |
| | J | 1.360 | 51-2, 67 & 100 | | | |
| | K | 1.770 | 67 | | | |
| Hardware Option | B - Fillister Head Jackscrew | | H - Socket Head Jackscrew | | | |
| | E - Extended Jackscrew | | F - Female Jackpost | | | |
| EMI Band Strap Option | Omit (Blank) - No Band | | M - Uncoiled .125" Wide Band | | L - Coiled .125" Wide Band | |



Notes

1. Assembly identified with manufacture's name and P/N, space permitting.
2. See 507-297 for 45° configuration
3. Symbol 'E' extended hardware is not to be used with straight backshell at max cable entry size.

Material/Finish

- Backshell - al alloy/see Table 2
- Hardware-crec/pasivated



507-296
EMI/RFI Lightweight Metal Backshell
MIL-DTL-83513

Table I: Dimensions

Hardware Mounting Options



Code B
Fillister Head Jackscrew



Code B
Fillister Head Jackscrew



Code F
Female Jackpost



Code E
Hardware
(See Note 3)

Style S

Side Entry (90°)



Style T

Top Entry (Straight)



| Size | A | | B | | C | | D | | E | | F | | Max Entry |
|------|-------|-------|-------|-------|-------|-------|-------|-------|-------|-------|-------|------|-----------|
| | in | mm | in | mm | in | mm | in | mm | in | mm | in | mm | |
| 09 | 0.775 | 19.69 | 0.340 | 8.64 | 0.565 | 14.35 | 0.520 | 13.21 | 0.440 | 11.18 | 0.250 | 6.35 | A |
| 15 | 0.925 | 23.50 | 0.340 | 8.64 | 0.715 | 18.16 | 0.520 | 13.21 | 0.590 | 14.99 | 0.250 | 6.35 | B |
| 21 | 1.075 | 27.31 | 0.340 | 8.64 | 0.865 | 21.97 | 0.520 | 13.21 | 0.740 | 18.80 | 0.250 | 6.35 | C |
| 25 | 1.175 | 29.85 | 0.340 | 8.64 | 0.965 | 24.51 | 0.520 | 13.21 | 0.840 | 21.34 | 0.250 | 6.35 | D |
| 31 | 1.325 | 33.66 | 0.340 | 8.64 | 1.115 | 28.32 | 0.520 | 13.21 | 0.990 | 25.15 | 0.250 | 6.35 | E |
| 37 | 1.475 | 37.47 | 0.340 | 8.64 | 1.265 | 32.13 | 0.520 | 13.21 | 1.140 | 28.96 | 0.250 | 6.35 | G |
| 51 | 1.425 | 36.20 | 0.380 | 9.65 | 1.215 | 30.86 | 0.610 | 15.49 | 1.090 | 27.69 | 0.290 | 7.37 | F |
| 51-2 | 1.825 | 46.36 | 0.340 | 8.64 | 1.615 | 41.02 | 0.520 | 13.21 | 1.490 | 37.85 | 0.250 | 6.35 | J |
| 67 | 2.225 | 56.52 | 0.340 | 8.64 | 2.015 | 51.18 | 0.520 | 13.21 | 1.890 | 48.01 | 0.250 | 6.35 | K |
| 69 | 1.725 | 43.82 | 0.380 | 9.65 | 1.515 | 38.48 | 0.610 | 15.49 | 1.390 | 35.31 | 0.290 | 7.37 | H |
| 75 | 2.070 | 52.58 | .380 | 9.65 | 1.705 | 43.30 | .520 | 13.20 | 1.490 | 37.85 | .290 | 7.37 | H |
| 100 | 2.160 | 54.86 | 0.430 | 10.92 | 1.800 | 45.72 | 0.630 | 16.00 | 1.522 | 38.66 | 0.340 | 8.64 | J |



507-178 EMI/RFI Micro-D Split Banding Backshell with Elliptical Banding Porch



Split Backshell With Elliptical Cable Entry provides added room for larger wire bundles. Terminate cable shields with BandMaster™ ATS microbands. This backshell features floating male screwlocks which allow full mating of the connector before the screws are fastened.

Rugged Aluminum housing with stainless steel hardware, available in standard nickel plating, or choose optional finishes.

| How To Order EMI/RFI Split Shell Backshells | | | | | | |
|---|---|--|---|--|--|--|
| Sample Part Number | 507-178 M 25 06 K F | | | | | |
| Series | 507-178 | | | | | |
| Shell Finish | E – Chem Film (Alodyne) M – Electroless Nickel Z2 – Gold | | J – Cadmium, Yellow Chromate NF – Cadmium, Olive Drab | | | |
| Connector Size | 09, 15, 21, 25, 31, 37, 51, 51-2, 67, 69, 100 (See Table I) | | | | | |
| Cable Entry Code | 04, 05, 06, 07, 08, 09, 10, 11, 12, 13, 14, 15, 16 (See Table II) | | | | | |
| EMI Band Strap Option | OMIT (Leave Blank) - Band Strap Not Supplied B - Microband Supplied (600-057) K - Coiled Microband Supplied (600-057-1) | | | | | |
| Hardware Option | E - Extended Screwlock FE - Extended Female Jackpost HJ - Hex Head Jackscrew | | F - Jackpost, Female FF - Fixed Female Jackpost EJ - Extended Jackscrew | | H - Hex Head Screwlock J - Fillister Head Jackscrew OMIT for standard knurl head screwlock | |

Notes

1. Assembly Identified with manufacturer's name and P/N space permitting.
2. Use Glenair 600-057 ban and 600-01 tool.
3. Screwlocks: screws float to allow connector to engage completely before tightening.
Jackscrews: screws must be tightened simultaneous with connector engagement
4. Shell size 09 may be supplied with optional configuration J dimension of 1.140 max.

Materials/Finish

- Shell: Aluminum Alloy
- Jackscrews, Washers, Jackposts: 300 Series Stainless Steel, Passivated
- See Ordering Info For Finish Options





507-178 EMI/RFI Micro-D Split Banding Backshell with Elliptical Banding Porch

Table I: Dimensions



See Note 4

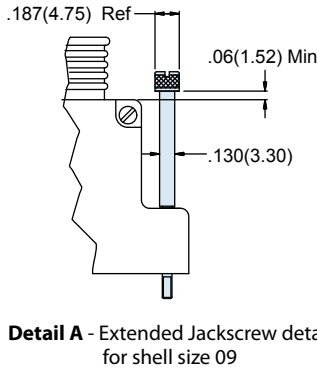

| Code | H | | Available on Shell Size |
|------|-----------|-----------|-------------------------|
| | In. ±.010 | mm. ±0.25 | |
| 04 | .250 | 6.35 | 09, 15, 21 |
| 05 | .312 | 7.92 | 15 Thru 31 |
| 06 | .375 | 9.53 | 21 Thru 51 |
| 07 | .437 | 11.10 | 25 Thru 51 |
| 08 | .500 | 12.70 | 25 Thru 51 |
| 09 | .562 | 14.27 | 31 Thru 100 |
| 10 | .625 | 15.88 | 31 Thru 100 |
| 11 | .688 | 17.48 | 37 Thru 100 |
| 12 | .750 | 19.05 | 37 Thru 100 |
| 13 | .812 | 20.62 | 37,51-2,67,69,100 |
| 14 | .875 | 22.23 | 51-2, 67, 69, 100 |
| 15 | .938 | 23.83 | 51-2, 67, 69, 100 |
| 16 | 1.000 | 25.40 | 51-2, 67, 69, 100 |

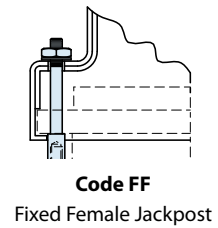
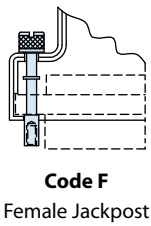
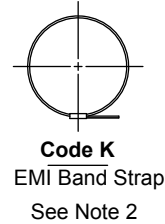

| Size | A Max. | | B | | C Max. | | D | | E | | F | | G Thread | Available Dash No. Table III |
|------|--------|-------|-------|-------|--------|-------|-----------|-----------|-----------|-----------|-----------|-----------|-------------|------------------------------|
| | In. | mm. | In. | mm. | In. | mm. | In. ±.010 | mm. ±0.25 | In. ±.020 | mm. ±.022 | In. ±.005 | mm. ±.127 | | |
| 09 | .915 | 23.24 | .565 | 14.35 | .450 | 11.43 | .701 | 17.81 | 1.013 | 25.73 | .160 | 4.06 | 2-56 UNC-2A | 04 |
| 15 | 1.065 | 27.05 | .715 | 18.16 | .450 | 11.43 | .763 | 19.38 | 1.076 | 27.33 | .190 | 4.83 | 2-56 UNC-2A | 04-05 |
| 21 | 1.215 | 30.86 | .865 | 21.97 | .450 | 11.43 | .795 | 20.19 | 1.107 | 28.12 | .220 | 5.59 | 2-56 UNC-2A | 04-06 |
| 25 | 1.315 | 33.40 | .965 | 24.51 | .450 | 11.43 | .857 | 21.77 | 1.170 | 29.72 | .260 | 6.60 | 2-56 UNC-2A | 05-08 |
| 31 | 1.465 | 37.21 | 1.115 | 28.32 | .450 | 11.43 | .888 | 22.56 | 1.201 | 30.51 | .275 | 6.99 | 2-56 UNC-2A | 05-10 |
| 37 | 1.615 | 41.02 | 1.265 | 32.13 | .450 | 11.43 | .951 | 24.16 | 1.263 | 32.08 | .285 | 7.24 | 2-56 UNC-2A | 06-13 |
| 51 | 1.565 | 39.75 | 1.215 | 30.86 | .495 | 12.57 | 1.013 | 25.73 | 1.326 | 33.68 | .350 | 8.89 | 2-56 UNC-2A | 06-12 |
| 51-2 | 1.965 | 49.91 | 1.615 | 41.02 | .450 | 11.43 | 1.013 | 25.73 | 1.326 | 33.68 | .350 | 8.89 | 2-56 UNC-2A | 13-16 |
| 67 | 2.365 | 60.07 | 2.015 | 51.18 | .450 | 11.43 | 1.013 | 25.73 | 1.326 | 33.68 | .350 | 8.89 | 2-56 UNC-2A | 13-16 |
| 69 | 1.865 | 47.37 | 1.515 | 38.48 | .495 | 12.57 | 1.013 | 25.73 | 1.326 | 33.68 | .350 | 8.89 | 2-56 UNC-2A | 13-16 |
| 100 | 2.305 | 58.55 | 1.800 | 45.72 | .540 | 13.72 | 1.076 | 27.33 | 1.388 | 35.26 | .490 | 12.45 | 4-40 UNC-2A | 09-16 |



507-198 Saddle Bar Strain-Relief Backshell



507-198 Strain Relief Backshells feature saddle bar cable clamps for easy installation.

Materials

- Shell: Aluminum Alloy 6061 -T6
- Clips: 17-7PH Stainless Steel
- Hardware: 300 Series Stainless Steel

How To Order Saddle Bar Strain Relief Backshells

| | | | |
|---------------------------|---|--|-----------|
| Sample Part Number | 507-198 | M | 25 |
| Series | 507-198 | | |
| Shell Finish | E – Chem Film (Alodyne) M – Electroless Nickel Z2 – Gold | J – Cadmium, Yellow Chromate NF – Cadmium, Olive Drab | |
| Connector Size | 09, 15, 21, 25, 31, 37, 51, 51-2, 67, 69, 100 (See Table I) | | |

Table I: Dimensions



| Size | A Max. | | B Max. | | C | | D Max. | | E | | F | |
|-------------|--------|-------|--------|-------|-------|-------|--------|-------|------|-------|-----|-------|
| | In. | mm. | In. | mm. | In. | mm. | In. | mm. | In. | mm. | In. | mm. |
| 09 | .850 | 21.59 | .420 | 10.67 | .565 | 14.35 | .840 | 21.34 | .31 | 7.87 | .31 | 7.87 |
| 15 | 1.000 | 25.40 | .420 | 10.67 | .715 | 18.16 | .910 | 23.11 | .38 | 9.65 | .31 | 7.87 |
| 21 | 1.150 | 29.21 | .420 | 10.67 | .865 | 21.97 | .970 | 24.64 | .44 | 11.18 | .31 | 7.87 |
| 25 | 1.250 | 31.75 | .420 | 10.67 | .965 | 24.51 | 1.030 | 26.16 | .50 | 12.70 | .31 | 7.87 |
| 31 | 1.400 | 35.56 | .420 | 10.67 | 1.115 | 28.32 | 1.080 | 27.43 | .55 | 13.97 | .31 | 7.87 |
| 37 | 1.550 | 39.37 | .420 | 10.67 | 1.265 | 32.13 | 1.130 | 28.70 | .60 | 15.24 | .31 | 7.87 |
| 51 | 1.500 | 38.10 | .470 | 11.94 | 1.215 | 30.86 | 1.080 | 27.43 | .55 | 13.97 | .36 | 9.14 |
| 51-2 | 1.910 | 48.51 | .420 | 10.67 | 1.615 | 41.02 | 1.480 | 37.59 | .95 | 24.13 | .31 | 7.87 |
| 67 | 2.310 | 58.67 | .420 | 10.67 | 2.015 | 51.18 | 1.880 | 47.75 | 1.35 | 34.29 | .31 | 7.87 |
| 69 | 1.810 | 45.97 | .470 | 11.94 | 1.515 | 38.48 | 1.380 | 35.05 | .85 | 21.59 | .36 | 9.14 |
| 100 | 2.235 | 56.77 | .510 | 12.95 | 1.800 | 45.72 | 1.650 | 41.91 | 1.00 | 25.40 | .40 | 10.04 |





507-146 Round Cable Entry Strain Relief Backshell with Saddle Bar Clamps



507-146 Strain Relief Backshells feature saddle bar clamps for easy installation.

E-Rings attach the backshell to the Micro-D connector.

Materials

- Shell: Aluminum Alloy 6061 -T6
- Clips: 17-7PH Stainless Steel
- Hardware: 300 Series Stainless Steel

| How To Order Round Cable Strain Relief Backshells | | | | | |
|---|--|---|--------------|----|-----|
| Sample Part Number | 507-146 | | M | 25 | H C |
| Series | 507-146 | | | | |
| Shell Finish | E – Chem Film (Alodyne) M – Electroless Nickel | J – Cadmium, Yellow Chromate NF – Cadmium, Olive Drab Z2 – Gold | | | |
| Connector Size | 09, 15, 21, 25, 31, 37 51, 51-2, 67, 69, 100 (See Table I) | | | | |
| Hardware Option | OMIT – Fillister Head Jackscrew E – Extended Jackscrew | H – Hex Head Jackscrew F – Jackpost, Female | | | |
| Jackscrew Attachment Option | OMIT (Leave Blank) – Jackscrews Attach With E-Ring. This Option Applies to Sizes 09 through 69. Size 100 is Not Available with E-Ring. | | C – "C" Clip | | |

Table I: Dimensions



| Size | A Max. | | B Max. | | C | | Ø D | | E Max. | | F Max. | | G Max. | |
|------|--------|-------|--------|-------|-------|-------|---------------|---------------|--------|-------|--------|-------|--------|-------|
| | In. | mm. | In. | mm. | In. | mm. | In. ± .010 | mm. ± 0.25 | In. | mm. | In. | mm. | In. | mm. |
| 09 | .915 | 23.24 | .450 | 11.43 | .565 | 14.35 | .160 | 4.06 | .780 | 19.81 | .550 | 13.97 | .540 | 13.72 |
| 15 | 1.065 | 27.05 | .450 | 11.43 | .715 | 18.16 | .190 | 4.83 | .830 | 21.08 | .600 | 15.24 | .590 | 14.99 |
| 21 | 1.215 | 30.86 | .450 | 11.43 | .865 | 21.97 | .220 | 5.59 | .940 | 23.88 | .650 | 16.51 | .700 | 17.78 |
| 25 | 1.315 | 33.40 | .450 | 11.43 | .965 | 24.51 | .260 | 6.60 | .990 | 25.15 | .700 | 17.78 | .740 | 18.80 |
| 31 | 1.465 | 37.21 | .450 | 11.43 | 1.115 | 28.32 | .275 | 6.99 | 1.030 | 26.16 | .740 | 18.80 | .790 | 20.07 |
| 37 | 1.615 | 41.02 | .450 | 11.43 | 1.265 | 32.13 | .285 | 7.24 | 1.070 | 27.18 | .780 | 19.81 | .830 | 21.08 |
| 51 | 1.565 | 39.75 | .495 | 12.57 | 1.215 | 30.86 | .350 | 8.89 | 1.150 | 29.21 | .860 | 21.84 | .910 | 23.11 |
| 51-2 | 1.965 | 49.81 | .450 | 11.43 | 1.615 | 41.02 | .285 | 7.24 | 1.150 | 29.21 | .860 | 21.84 | .910 | 23.11 |
| 67 | 2.365 | 60.07 | .450 | 11.43 | 2.015 | 51.18 | .285 | 7.24 | 1.150 | 29.21 | .860 | 21.84 | .910 | 23.11 |
| 69 | 2.265 | 57.53 | .495 | 12.57 | 1.515 | 38.48 | .350 | 8.89 | 1.150 | 29.21 | .860 | 21.84 | .910 | 23.11 |
| 100 | 2.305 | 58.55 | .540 | 13.72 | 1.800 | 45.72 | .490 | 12.45 | 1.210 | 30.73 | .930 | 23.62 | .970 | 24.63 |



500-012 Qwik-Ty Strain Relief Backshell



Qwik-Ty Backshell is stocked in all sizes. Choose "M" Nickel Finish and "T" top entry for best availability. Customer-furnished cable ties provide strain relief to wire bundles. Suitable for jacketed cable or use with individual wires.

Materials

- Shell: Aluminum Alloy 6061 -T6
- Clips: 17-7PH Stainless Steel
- Hardware: 300 Series Stainless Steel

| How To Order Qwik-Ty Strain Relief Backshells | | | | | | |
|---|--|----------------------|--|---|----|---|
| Sample Part Number | 500T012 | | | M | 25 | H |
| Series | 500T012 - Top Entry | 500S012 - Side Entry | 500E012 - 45° Entry | | | |
| Shell Finish | E - Chem Film (Alodyne) M - Electroless Nickel Z2 - Gold | | J - Cadmium, Yellow Chromate NF - Cadmium, Olive Drab | | | |
| Connector Size | 09, 15, 21, 25, 31, 37 51, 51-2, 67, 69, 100 (See Table I) | | | | | |
| Hardware Option | B - Fillister Head Jackscrew E - Extended Jackscrew | | H - Hex Head Jackscrew F - Jackpost, Female | | | |

Table I: Dimensions



| Size | A Max. | | B Max. | | C | | D Max. | | E Max. | | F | | H Max. | | J Max. | | K | | L Max. | | M Max. | | N Max. | |
|------|--------|-------|--------|-------|-------|-------|--------|-------|--------|-------|------|------|--------|-------|--------|-------|------|-------|--------|-------|--------|-------|--------|-------|
| | In. | mm. | In. | mm. | In. | mm. | In. | mm. | In. | mm. | In. | mm. | In. | mm. | In. | mm. | In. | mm. | In. | mm. | In. | mm. | In. | mm. |
| 09 | .850 | 21.59 | .370 | 9.40 | .565 | 14.35 | .780 | 19.81 | .410 | 10.41 | .156 | 3.18 | .350 | 8.89 | .637 | 16.18 | .435 | 11.05 | 1.040 | 26.42 | 1.000 | 25.40 | .680 | 17.27 |
| 15 | 1.000 | 25.40 | .370 | 9.40 | .715 | 18.16 | .910 | 23.11 | .580 | 14.73 | .188 | 3.96 | .470 | 11.94 | .673 | 17.09 | .440 | 11.20 | 1.170 | 29.72 | 1.030 | 26.16 | .730 | 18.54 |
| 21 | 1.150 | 29.21 | .370 | 9.40 | .865 | 21.97 | 1.030 | 26.16 | .740 | 18.80 | .219 | 4.78 | .590 | 14.99 | .707 | 17.95 | .458 | 11.63 | 1.290 | 32.77 | 1.050 | 26.67 | .765 | 19.43 |
| 25 | 1.250 | 31.75 | .370 | 9.40 | .965 | 24.51 | 1.090 | 27.69 | .850 | 21.59 | .250 | 5.56 | .650 | 16.51 | .748 | 19.00 | .483 | 12.27 | 1.350 | 34.29 | 1.090 | 27.69 | .830 | 21.08 |
| 31 | 1.400 | 35.56 | .370 | 9.40 | 1.115 | 28.32 | 1.150 | 29.21 | .980 | 24.89 | .265 | 6.35 | .710 | 18.03 | .756 | 19.20 | .476 | 12.09 | 1.420 | 36.07 | 1.130 | 28.70 | .890 | 22.61 |
| 37 | 1.550 | 39.37 | .370 | 9.40 | 1.265 | 32.13 | 1.190 | 30.23 | 1.130 | 28.70 | .281 | 7.14 | .750 | 19.05 | .774 | 19.66 | .478 | 12.14 | 1.450 | 36.83 | 1.230 | 31.24 | .955 | 24.26 |
| 51 | 1.500 | 38.10 | .410 | 10.41 | 1.215 | 30.86 | 1.220 | 30.99 | 1.080 | 27.43 | .312 | 7.92 | .780 | 19.81 | .859 | 21.82 | .548 | 13.91 | 1.480 | 37.59 | 1.250 | 31.75 | 1.005 | 25.53 |
| 51-2 | 1.910 | 48.51 | .370 | 9.40 | 1.615 | 41.02 | 1.220 | 30.99 | 1.510 | 38.35 | .281 | 7.14 | .780 | 19.81 | .859 | 21.82 | .548 | 13.91 | 1.480 | 37.59 | 1.250 | 31.75 | 1.005 | 25.53 |
| 67 | 2.310 | 58.67 | .370 | 9.40 | 2.015 | 51.18 | 1.220 | 30.99 | 1.880 | 47.75 | .281 | 7.14 | .780 | 19.81 | .859 | 21.82 | .548 | 13.91 | 1.480 | 37.59 | 1.250 | 31.75 | 1.005 | 25.53 |
| 69 | 1.810 | 45.97 | .410 | 10.41 | 1.515 | 38.48 | 1.220 | 30.99 | 1.380 | 47.75 | .312 | 7.92 | .780 | 19.81 | .859 | 21.82 | .548 | 13.91 | 1.480 | 37.59 | 1.250 | 31.75 | 1.005 | 25.53 |
| 100 | 2.235 | 56.77 | .460 | 11.68 | 1.800 | 45.72 | 1.280 | 32.51 | 1.470 | 37.34 | .375 | 9.53 | .840 | 21.34 | 1.014 | 25.76 | .687 | 17.45 | 1.580 | 40.13 | 1.320 | 33.53 | 1.080 | 27.43 |



507-035 Potting Shell



Potting Shells provide easy encapsulation of Micro-D solder cup terminations. These potting shells provide .25 inches (6.3 mm.) of depth.

Materials

- Shell: Aluminum Alloy 6061 -T6
- Clips: 17-7PH Stainless Steel
- Hardware: 300 Series Stainless Steel

| How To Order Potting Shells | | | | | |
|-----------------------------|--|--|-----------|----|---|
| Sample Part Number | 507-035 | | M | 25 | H |
| Series | 507-035 | | | | |
| Shell Finish | E – Chem Film (Alodyne) M – Electroless Nickel | J – Cadmium, Yellow Chromate NF – Cadmium, Olive Drab | Z2 – Gold | | |
| Connector Size | 09, 15, 21, 25, 31, 37 51, 51-2, 67, 69, 100 (See Table I) | | | | |
| Hardware Option | Omit – Fillister Head Jackscrew E – Extended Jackscrew | H – Hex Head Jackscrew F – Jackpost, Female (See Table I) | | | |

Table I: Dimensions



| Size | A Max. | | B Max. | | C | | D | | E | |
|------|--------|-------|--------|-------|-------|-------|---------------|--------------|---------------|--------------|
| | In. | mm. | In. | mm. | In. | mm. | In. ± .030 | mm. ± 0.8 | In. ± .030 | mm. ± 0.8 |
| 09 | .850 | 21.59 | .370 | 9.40 | .565 | 14.35 | .31 | 7.9 | .26 | 6.6 |
| 15 | 1.000 | 25.40 | .370 | 9.40 | .715 | 18.16 | .48 | 12.2 | .26 | 6.6 |
| 21 | 1.150 | 29.21 | .370 | 9.40 | .865 | 21.97 | .65 | 16.5 | .26 | 6.6 |
| 25 | 1.250 | 31.75 | .370 | 9.40 | .965 | 24.51 | .75 | 19.1 | .26 | 6.6 |
| 31 | 1.400 | 35.56 | .370 | 9.40 | 1.115 | 28.32 | .88 | 22.4 | .26 | 6.6 |
| 37 | 1.550 | 39.37 | .370 | 9.40 | 1.265 | 32.13 | 1.03 | 26.2 | .26 | 6.6 |
| 51 | 1.500 | 38.10 | .410 | 10.41 | 1.215 | 30.86 | .98 | 24.9 | .30 | 7.6 |
| 51-2 | 1.910 | 48.51 | .370 | 9.40 | 1.615 | 41.02 | 1.38 | 35.0 | .26 | 6.6 |
| 67 | 2.310 | 58.67 | .370 | 9.40 | 2.015 | 51.18 | 1.78 | 45.2 | .26 | 6.6 |
| 69 | 1.810 | 45.97 | .410 | 10.41 | 1.515 | 38.48 | 1.28 | 32.5 | .30 | 7.6 |
| 100 | 2.235 | 56.77 | .460 | 11.68 | 1.800 | 45.72 | 1.35 | 34.3 | .36 | 9.1 |

M

Section N
Micro-D Sav-Con Connector Savers,
Hardware and Accessories



Product Selection Guide

Connector
Saver
Page N-2



Micro-D Connector Saver

Always in stock, these feed-thru pin-socket adapters feature an innovative design using a single machined aluminum housing. Fully EMI protected, Uni-Savers protect expensive equipment from damage during testing and burn-in. Available in all sizes.

Gender
Changer
Page N-3



Micro-D In-line Gender Changers

Mixed signal and power plug to receptacle gender changers feature feed-thru pin-socket adapters and provide a convenient solution to mis-matched cables.

Shorting
Adapters
Page N-4



Shorting Adapters

Combining a switching backshell and a Micro-D connector, these assemblies have all contacts shorted to each other. These shorting plugs provide ESD protection to sensitive instrumentation.

Dust Caps
Page N-5



Micro-D Plastic Dust Caps

Always in stock, these anti-static black LDPE dust caps protect Micro-D connectors from debris and damage. All Glenair Micro-D connectors are furnished with these dust caps; however, these caps may be purchased separately for replacements.

Interfacial Seals
Page N-5



Interfacial Seals

Replace damaged Micro-D socket connector interfacial seals with new ones. Sometimes these seals can tear or be contaminated. Held in place by an interference fit with the contacts, damaged seals can be removed with tweezers.

Metal Covers
Page N-6



Micro-D Metal Protective Covers

These aluminum covers provide complete mechanical and environmental protection. A silicone gasket assures water-tight sealing. A variety of attachment styles are available.

Rubber Covers
Page N-10



Bean Rubber Covers

For protection of Micro-D's used in tactical equipment, these synthetic rubber covers are friction-fit and attach with nylon cord and ring terminals.

Jackscrew Kits
Page N-11



Jackscrew Kits

These stainless steel kits are compatible with standard Micro-D connectors and meet the requirements of MIL-DTL-83513. Jackscrews are available with slot heads or hex heads. Choose low profile or extended length versions.

Jackpost Kits
Page N-13



Jackpost Kits

Jackposts are available in various lengths to fit front and rear panel mounted connectors. These stainless steel jackposts fit all standard Micro-D connectors.



Sav-Con® Connector Saver MWDM2L



Compact Size reduces stress on mating connectors.

In Stock, No Waiting – All standard Uni-Saver sizes are in stock (9, 15, 21, 25, 31, 37, 51, 75, 100 and 130 pin).

EMI Protected one piece shell.

| Materials & Finishes | |
|----------------------|--|
| Shell | Aluminum Alloy 6061 -T6 Electroless Nickel Plated |
| Contacts | Gold-Plated Copper Alloy |
| Encapsulant | Epoxy |
| Insulators | Glass-Filled LCP |
| Hardware | 300 Series Stainless Steel, Passivated |

Protect Expensive Equipment With Glenair's Micro-D Connector Saver

These connector savers feature a one-piece aluminum housing, TwistPin contacts and locking hardware. Typical applications include test equipment and space-grade instruments. The Connector Saver prevents wear and tear on sensitive gear. Standard Connector Savers are electroless nickel plated. Other plating finishes are available on request.

Dimensions



| Size | Part Number | A Max. | | B | | C Max. | | D Max. | | E Max. | | F | | H | | J Max. | | K Max. | |
|------|-----------------|--------|-------|--------------|--------------|--------|-------|--------|------|--------|-------|--------------|--------------|--------------|--------------|--------|-------|--------|------|
| | | In. | mm. | In. ±.003 | mm. ±0.08 | In. | mm. | In. | mm. | In. | mm. | In. ±.003 | mm. ±0.08 | In. ±.003 | mm. ±0.08 | In. | mm. | In. | mm. |
| 9 | MWDM2L-9USP1 | .785 | 19.94 | .565 | 14.35 | .400 | 10.16 | .250 | 6.35 | .308 | 7.82 | .195 | 4.95 | .183 | 4.65 | .333 | 8.46 | .184 | 4.67 |
| 15 | MWDM2L-15USP1 | .935 | 23.75 | .715 | 18.16 | .551 | 14.00 | .250 | 6.35 | .308 | 7.82 | .195 | 4.95 | .183 | 4.65 | .483 | 12.27 | .184 | 4.67 |
| 21 | MWDM2L-21USP1 | 1.085 | 27.56 | .865 | 21.97 | .701 | 17.81 | .250 | 6.35 | .308 | 7.82 | .195 | 4.95 | .183 | 4.65 | .633 | 16.08 | .184 | 4.67 |
| 25 | MWDM2L-25USP1 | 1.185 | 30.01 | .965 | 24.51 | .801 | 20.35 | .250 | 6.35 | .308 | 7.82 | .195 | 4.95 | .183 | 4.65 | .733 | 18.62 | .184 | 4.67 |
| 31 | MWDM2L-31USP1 | 1.335 | 33.91 | 1.115 | 28.32 | .951 | 24.16 | .250 | 6.35 | .308 | 7.82 | .195 | 4.95 | .183 | 4.65 | .883 | 22.43 | .184 | 4.67 |
| 37 | MWDM2L-37USP1 | 1.485 | 37.72 | 1.265 | 32.13 | 1.101 | 27.96 | .250 | 6.35 | .308 | 7.82 | .195 | 4.95 | .183 | 4.65 | 1.033 | 26.24 | .184 | 4.67 |
| 51 | MWDM2L-51USP1 | 1.435 | 36.45 | 1.215 | 30.86 | 1.051 | 26.70 | .296 | 7.52 | .351 | 8.92 | .195 | 4.95 | .183 | 4.65 | .983 | 24.97 | .228 | 5.79 |
| 51-2 | MWDM2L-51-2USP1 | 1.835 | 46.61 | 1.615 | 41.02 | 1.450 | 36.83 | .250 | 6.35 | .308 | 7.82 | .195 | 4.95 | .183 | 4.65 | 1.384 | 35.15 | .184 | 4.67 |
| 67 | MWDM2L-67USP1 | 2.235 | 56.77 | 2.015 | 51.18 | 1.850 | 46.99 | .250 | 6.35 | .308 | 7.82 | .195 | 4.95 | .183 | 4.65 | 1.784 | 45.31 | .184 | 4.67 |
| 69 | MWDM2L-69USP1 | 1.735 | 44.07 | 1.515 | 38.48 | 1.350 | 34.29 | .296 | 7.52 | .351 | 8.92 | .195 | 4.95 | .183 | 4.65 | 1.284 | 32.61 | .228 | 5.79 |
| 75 | MWDM2L-75USP1 | 2.080 | 52.80 | 1.705 | 43.30 | 1.450 | 36.80 | .296 | 7.52 | .351 | 8.92 | .195 | 4.95 | .183 | 4.65 | 1.384 | 35.20 | .228 | 5.79 |
| 100 | MWDM2L-100USP1 | 2.170 | 55.12 | 1.800 | 45.72 | 1.451 | 36.86 | .333 | 8.46 | .394 | 10.01 | .195 | 4.95 | .183 | 4.65 | 1.383 | 35.13 | .270 | 6.86 |
| 130 | MWDM2L-130USP1 | 2.520 | 64.00 | 2.160 | 54.86 | 1.795 | 45.60 | .333 | 8.46 | .394 | 10.01 | .195 | 4.95 | .183 | 4.65 | 1.735 | 44.07 | .270 | 6.86 |

N

Sav-Con® Gender Changer Mixed Signal and Power Plug to Receptacle Gender Changer



How To Order Shorting Plugs

| | | | | | |
|--|--|--------------|------------|-----------|-----------|
| Sample Part Number | MRM17109 | -E112 | -PR | -2 | -B |
| Generic Part No. | Sav-Con Gender Changer | | | | |
| Insert Arrangement and Shell Size | See Table I | | | | |
| Sav-Con Gender | PR - Plug to Receptacle | | | | |
| Shell Plating/Finish | 1 - Cadmium 2 - Eelctroless Nickel 3 - Stainless Steel Passivated 4 - Black Anodize 5 - Gold 6 - Allochrome | | | | |
| Hardware | B - Though Hole P - Jackpost JP1 - Extended Jackpost (plug) JP2 - Extended jackpost (receptacle) JPL - Extended jackpost (supplied loose piece) | | | | |

Sav-Con Gender Changers are the solution for mis-matched cables. Available for power only or power and signal combinations in 9 insert arrangements.

Table I: Dimensions



| Contact Arrangement | Shell Size | Power Contact Quantity | Micro Contact Quantity | F Max | | H Max | |
|------------------------|------------|------------------------|------------------------|-------|------|-------|-------|
| | | | | In. | mm. | In. | mm. |
| MRM17109-B112PR | 2 | 2 | 0 | 0.257 | 6.53 | 13.97 | 0.550 |
| MRM17109-D112PR | 4 | 3 | 0 | 0.257 | 6.53 | 20.32 | 0.800 |
| MRM17109-D113PR | 4 | 2 | 6 | 0.257 | 6.53 | 20.32 | 0.800 |
| MRM17109-E112PR | 5 | 4 | 0 | 0.257 | 6.53 | 24.13 | 0.950 |
| MRM17109-E113PR | 5 | 3 | 8 | 0.257 | 6.53 | 24.13 | 0.950 |
| MRM17109-G101PR | 7 | 4 | 22 | 0.306 | 7.77 | 26.67 | 1.050 |
| MRM17109-G103PR | 7 | 6 | 6 | 0.306 | 7.77 | 26.67 | 1.050 |
| MRM17109-G111PR | 7 | 4 | 20 | 0.306 | 7.77 | 26.67 | 1.050 |
| MRM17109-J112PR | 9 | 6 | 0 | 0.257 | 6.53 | 36.83 | 1.450 |

Hardware



JP1 = Extended Jackpost (plug)



JP2 = Extended Jackpost (receptacle)

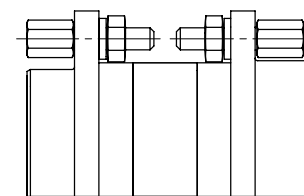

P = Jackpost (plug and receptacle)

For Specific shell layout dimension data please refer to GDS162



Shorting Plug Assembly 177-007



Shorting Plug Assemblies are Micro-D connectors with all contacts bussed/shorted together. Enclosed in a backshell and fitted with jackscrews, these shorting plugs provide ESD protection to sensitive instrumentation.

| Materials & Finishes | |
|----------------------|--|
| Shells | Aluminum Alloy 6061 -T6 |
| Contacts | Gold-Plated Copper Alloy |
| Encapsulant | Epoxy |
| Insulators | Glass-Filled LCP |
| Interfacial Seal | Fluorosilicone |
| Hardware | 300 Series Stainless Steel, Passivated |

| How To Order Shorting Plugs | |
|------------------------------------|---|
| Sample Part Number | 177-007 -25 S 2 H F 6 -06 |
| Series | 177-007 |
| Connector Size | 9, 15, 21, 25, 31, 37, 51, 51-2, 67, 69, 100 (Table I) |
| Contact Type | P - Pin S - Socket |
| Shell Finish | 1 - Cadmium, Yellow Chromate 2 - Electroless Nickel 4 - Black Anodize 5 - Gold 6 - Chem Film |
| Hardware Option | B - Fillister Head Jackscrew H - Hex Head Jackscrew E - Extended Jackscrew F - Jackpost, Female N - No Hardware |
| Lanyard Option | N - No Lanyard G - Flexible Nylon Rope F - Wire Rope, Nylon Jacket H - Wire Rope, Teflon Jacket |
| Lanyard Length | Length in One Inch Increments; Example: "6" equals six inches. |
| Ring Terminal Ordering Code | 01 - .140 (3.6) 04 - .197 (5.0) 05 - .167 (4.2) 06 - .125 (3.2) I.D. of Ring Terminal |

Table I: Dimensions



| Size | A Max. | | B Max. | | C | | D Max. | | E Max. | | F Max. | |
|-------------|--------|-------|--------|-------|-------|-------|--------|-------|--------|-------|--------|-------|
| | In. | mm. | In. | mm. | In. | mm. | In. | mm. | In. | mm. | In. | mm. |
| 9 | .850 | 21.59 | .370 | 9.40 | .565 | 14.35 | .600 | 15.24 | .450 | 11.43 | .410 | 10.41 |
| 15 | 1.000 | 25.40 | .370 | 9.40 | .715 | 18.16 | .720 | 18.29 | .570 | 14.48 | .580 | 14.73 |
| 21 | 1.150 | 29.21 | .370 | 9.40 | .865 | 21.97 | .840 | 21.34 | .690 | 17.53 | .740 | 18.80 |
| 25 | 1.250 | 31.75 | .370 | 9.40 | .965 | 24.51 | .900 | 22.86 | .750 | 19.05 | .850 | 21.59 |
| 31 | 1.400 | 35.56 | .370 | 9.40 | 1.115 | 28.32 | .960 | 24.38 | .810 | 20.57 | .980 | 24.89 |
| 37 | 1.550 | 39.37 | .370 | 9.40 | 1.265 | 32.13 | 1.000 | 25.40 | .850 | 21.59 | 1.130 | 28.70 |
| 51 | 1.500 | 38.10 | .410 | 10.41 | 1.215 | 30.86 | 1.030 | 26.16 | .880 | 22.35 | 1.080 | 27.43 |
| 51-2 | 1.910 | 48.51 | .370 | 9.40 | 1.615 | 41.02 | 1.030 | 26.16 | .880 | 22.35 | 1.510 | 38.35 |
| 67 | 2.310 | 58.67 | .370 | 9.40 | 2.015 | 51.18 | 1.030 | 26.16 | .880 | 22.35 | 1.880 | 47.75 |
| 69 | 1.810 | 45.97 | .410 | 10.41 | 1.515 | 38.48 | 1.030 | 26.16 | .880 | 22.35 | 1.380 | 35.02 |
| 100 | 2.235 | 56.77 | .460 | 11.68 | 1.800 | 45.72 | 1.090 | 27.69 | .940 | 23.88 | 1.470 | 37.34 |

N

Anti-Static Thermoplastic Dust Caps and Fluorosilicone Interfacial Seals



Anti-Static Dust Caps

Anti-Static Dust Caps offer protection to Micro-D connectors for storage and handling. Molded in black thermoplastic LDPE, these caps meet the anti-static decay rate specified in MIL-PRF-81705D. **UL 94-V0** rated, self-extinguishing

| MWDM Connectors | | | | | | MLDM and MWDL Connectors | | | | | |
|-----------------|--------|--------|-------|--------|-------|--------------------------|--------|--------|-------|--------|-------|
| Part Number | Layout | A Ref. | | B Ref. | | Part Number | Layout | A Ref. | | B Ref. | |
| | | In. | mm. | In. | mm. | | | In. | mm. | In. | mm. |
| 000-01-09-162 | 9P | .524 | 13.31 | .393 | 9.98 | 000-01-09-164 | 9P | .491 | 12.47 | .349 | 8.86 |
| 000-01-15-162 | 15P | .647 | 16.43 | .393 | 9.98 | 000-01-15-164 | 15P | .639 | 16.23 | .349 | 8.86 |
| 000-01-21-162 | 21P | .824 | 20.93 | .393 | 9.98 | 000-01-21-164 | 21P | .789 | 20.04 | .349 | 8.86 |
| 000-01-25-162 | 25P | .924 | 23.47 | .393 | 9.98 | 000-01-25-164 | 25P | .889 | 22.58 | .349 | 8.86 |
| 000-01-31-162 | 31P | 1.074 | 27.28 | .393 | 9.98 | 000-01-31-164 | 31P | 1.039 | 26.39 | .349 | 8.86 |
| 000-01-37-162 | 37P | 1.224 | 31.09 | .393 | 9.98 | 000-01-37-164 | 37P | 1.189 | 30.20 | .349 | 8.86 |
| 000-01-51-162 | 51P | 1.174 | 29.82 | .393 | 9.98 | 000-01-51-164 | 51P | 1.139 | 28.93 | .390 | 9.90 |
| 000-01-51-172 | 51-2P | 1.574 | 39.98 | .320 | 8.13 | 000-01-09-165 | 9S | .565 | 14.35 | .392 | 9.96 |
| 000-01-67-162 | 67P | 1.974 | 50.14 | .250 | 6.35 | 000-01-15-165 | 15S | .715 | 18.16 | .392 | 9.96 |
| 000-01-69-162 | 69P | 1.474 | 37.44 | .320 | 8.13 | 000-01-21-165 | 21S | .865 | 21.97 | .392 | 9.96 |
| 000-01-75-162 | 75P | 1.574 | 39.98 | .436 | 11.07 | 000-01-25-165 | 25S | .965 | 24.51 | .392 | 9.96 |
| 000-01-00-162 | 100P | 1.574 | 39.98 | .250 | 6.35 | 000-01-31-165 | 31S | 1.115 | 28.32 | .392 | 9.96 |
| 000-01-30-162 | 130P | 1.947 | 49.45 | .476 | 12.09 | 000-01-37-165 | 37S | 1.265 | 32.13 | .392 | 9.96 |
| 000-01-09-163 | 9S | .563 | 14.30 | .428 | 10.87 | 000-01-51-165 | 51S | 1.215 | 30.86 | .435 | 11.05 |
| 000-01-15-163 | 15S | .713 | 18.11 | .428 | 10.87 | | | | | | |
| 000-01-21-163 | 21S | .863 | 21.92 | .428 | 10.87 | | | | | | |
| 000-01-25-163 | 25S | .963 | 24.46 | .428 | 10.87 | | | | | | |
| 000-01-31-163 | 31S | 1.113 | 28.27 | .428 | 10.87 | | | | | | |
| 000-01-37-163 | 37S | 1.263 | 32.08 | .428 | 10.87 | | | | | | |
| 000-01-51-163 | 51S | 1.213 | 30.81 | .470 | 11.94 | | | | | | |
| 000-01-51-173 | 51-2S | 1.612 | 40.94 | .428 | 10.87 | | | | | | |
| 000-01-67-163 | 67S | 2.013 | 51.13 | .428 | 10.87 | | | | | | |
| 000-01-69-163 | 69S | 1.512 | 38.40 | .470 | 11.94 | | | | | | |
| 000-01-75-163 | 75S | 1.612 | 40.94 | .470 | 11.94 | | | | | | |
| 000-01-00-163 | 100S | 1.615 | 41.02 | .516 | 13.11 | | | | | | |
| 000-01-30-163 | 130S | 1.975 | 50.16 | .504 | 12.80 | | | | | | |



Interfacial Seals For Metal Shell Micro-D Socket Connectors

Replacement Interfacial Seals fit Micro-D metal shell socket connectors. These blue fluorosilicone seals allow replacement of damaged seals.



| Layout | Part Number | A Ref. | | B Ref. | |
|--------|---------------|--------|-------|--------|------|
| | | In. | mm. | In. | mm. |
| 9S | 000-01-09-132 | .330 | 8.4 | .180 | 4.6 |
| 15S | 000-01-15-132 | .480 | 12.2 | .180 | 4.6 |
| 21S | 000-01-21-132 | .630 | 16.0 | .180 | 4.6 |
| 25S | 000-01-25-132 | .730 | 18.5 | .180 | 4.6 |
| 31S | 000-01-31-132 | .880 | 22.4 | .180 | 4.6 |
| 37S | 000-01-37-132 | 1.030 | 26.2 | .180 | 4.6 |
| 51S | 000-01-51-132 | .976 | 24.8 | .223 | 5.7 |
| 51-2S | 000-01-51-143 | 1.380 | 35.03 | .180 | 4.6 |
| 67S | 000-01-67-132 | 1.780 | 45.21 | 0.180 | 4.60 |
| 69S | 000-01-69-132 | 1.276 | 32.41 | 0.223 | 5.70 |
| 75S | 000-01-75-132 | 1.376 | 34.95 | 0.223 | 5.70 |
| 100S | 000-01-00-132 | 1.386 | 35.20 | 0.270 | 6.90 |
| 130S | 000-01-30-132 | 1.736 | 44.09 | .270 | 6.90 |



Metal Protective Covers with Silicone Rubber Gaskets 500-017 and 500-037



Choose Metal Protective Covers for full environmental protection.
Silicone Rubber Gasket provides a watertight seal.
Use with M83513 Type Metal Shell Micro-D Connectors

| Select A Protective Cover Style | | |
|--|---|--|
| Style 1 | Style 2 | Style 3 |
| | | |
| Use With Micro-D Connectors With Jackposts Not for rear panel mounted connectors. | Use With Micro-D Connectors With Jackscrews | Use With Rear-Panel Mounted Micro-D Connectors |

| How To Order 500-017 Style 1 and 2 Protective Covers | | | | | | | | | | |
|--|--|--|--|----|--------------------------------------|---|-----------------|-----|-----------------------|--|
| Sample Part Number | 500-017 | | M | 25 | MB | F | 4 | -06 | | |
| Series | 500-017 | | | | | | | | | |
| Shell Finish | B - Cad/Olive Drab J - Cadmium, Yellow Chromate Drab R - Red Anodize Z2 - Gold | | C - Black Anodize Nickel M - Electroless Y - Gold Iridite Over Cadmium Plate ME - Electroless Nickel, Grade A | | E - Chem Film NF - Cadmium, Olive | | | | | |
| Shell Size | 09, 15, 21, 25, 31, 37, 51, 51-2, 67, 69, 100 (See Table I) | | | | | | | | | |
| Hardware Option | STYLE 1 Fits Micro-D With Jackposts, Cover has Jackscrews MB - Fillister Head Jackscrew (See Note 3) MH - Hex Head Jackscrew (See Note 3) | | STYLE 2 Fits Micro-D's With Jackscrews Cover has Tapped Female Threads F - Female Threads | | | | | | | |
| Lanyard Option | N - No Lanyard F - Wire Rope, Nylon Jacket H - Wire Rope, Hi-Temp Fluoropolymer Jacket | | G - Flexible Nylon Rope R - Wire Rope, PVC Jacket | | T - Wire Rope, No Jacket | | | | | |
| Lanyard Length | Length in One Inch Increments; Example: "6" equals six inches. | | | | | | | | | |
| Ring Terminal Ordering Code | 01 - .140 (3.6) | | 04 - .197 (5.0) | | 05 - .167 (4.2) | | 06 - .125 (3.2) | | I.D. of Ring Terminal | |

| How To Order Style 500-037 Style 3 Protective Cover | | | | | | | | | |
|---|---|--|---|----|---|---|------------------------|-----|---|
| Sample Part Number | 500-037 | | M | 09 | R3 | B | F | -01 | -2 |
| Series | 500-037 | | | | | | | | |
| Shell Finish | C - Black Anodize Nickel J - Cadmium, Yellow Chromate Drab M - Electroless R - Red Anodize | | E - Chem Film N - Cadmium Plate/Olive Drab NF - Cadmium, Olive Z2 - Gold | | Y - Gold Iridite over Cadmium Plate | | | | |
| Shell Size | 9, 15, 21, 25, 31, 37, 51, 51-2, 67, 69, 100 (See Table I) | | | | | | | | |
| Rear Mounted (Omit for Front Mount) | R1 - .031 (0.79) Panel | | R2 - .047 (1.19) Panel | | R3 - .062 (1.57) Panel | | R4 - .093 (2.36) Panel | | |
| Hardware Option | B - (2) Male Fillister Head FB - (1) Female Jackpost and (1) Male Fillister Head | | H - (2) Male Hex Socket | | F - (2) Female Jackpost FH - (1) Female Jackpost (1) Male Hex Socket | | | | |
| Lanyard Length | N - No Lanyard F - Wire Rope, Nylon Jacket | | G - Flexible Nylon Rope H - Wire Rope, Hi-Temp Fluoropolymer Jacket | | R - Wire Rope, PVC Jacket T - Wire Rope, No Jacket | | | | |
| Attachment Ring "G" Dia. | 01 - .140 (3.6) | | 02 - .182 (4.6) | | 03 - .191 (4.8) | | 04 - .197 (5.0) | | 05 - .167 (4.2) 06 - .125 (3.2) 07 - .218 (5.5) |
| Attachment Length Opt | Example 2 = 2 inches (omit for standard 4 inch) | | | | | | | | |

N

Metal Protective Covers with Silicone Rubber Gaskets 500-017 and 500-037



Table I: Protective Cover Dimensions

| Style 1 | Style 2 | Style 3 |
|--|---|---|
| <p>#2-56 UNC THREADS SIZES 9-69 #4-40 UNC THREADS SIZE 100</p> <p>For Micro-D Connectors With Jackposts</p> | <p>#2-56 UNC THREADS SIZES 9-69 #4-40 UNC THREADS SIZE 100</p> <p>For Micro-D Connectors With Jackscrews</p> | <p>#2-56 UNC THREADS SIZES 9-69 #4-40 UNC THREADS SIZE 100</p> <p>For Rear-Panel Mounted Micro-D</p> |

| Dimensions for Style 1 and 2 | | | | | | | | | | |
|------------------------------|--------|------|--------|------|-------|-------|--------|------|--------|------|
| Size | A Max. | | B Max. | | C | | D Max. | | E Max. | |
| | In. | mm. | In. | mm. | In. | mm. | In. | mm. | In. | mm. |
| 9 | .453 | 11.5 | .930 | 23.6 | .565 | 14.35 | .380 | 9.7 | .795 | 20.2 |
| 15 | .453 | 11.5 | 1.080 | 27.4 | .715 | 18.16 | .380 | 9.7 | .945 | 24.0 |
| 21 | .453 | 11.5 | 1.230 | 31.2 | .865 | 21.97 | .380 | 9.7 | 1.095 | 27.8 |
| 25 | .453 | 11.5 | 1.330 | 33.8 | .965 | 24.51 | .380 | 9.7 | 1.195 | 30.4 |
| 31 | .453 | 11.5 | 1.480 | 37.6 | 1.115 | 28.32 | .380 | 9.7 | 1.345 | 34.2 |
| 37 | .453 | 11.5 | 1.630 | 41.4 | 1.265 | 32.13 | .380 | 9.7 | 1.495 | 38.0 |
| 51 | .496 | 12.6 | 1.580 | 40.1 | 1.215 | 30.86 | .420 | 10.7 | 1.445 | 36.7 |
| 51-2 | .453 | 11.5 | 1.980 | 50.3 | 1.615 | 41.02 | .380 | 9.7 | 1.845 | 46.9 |
| 67 | .453 | 11.5 | 2.380 | 60.5 | 2.015 | 51.18 | .380 | 9.7 | 2.245 | 57.0 |
| 69 | .496 | 12.6 | 1.880 | 47.8 | 1.515 | 38.48 | .420 | 10.7 | 1.745 | 44.3 |
| 100 | .539 | 13.7 | 2.315 | 58.8 | 1.800 | 45.72 | .470 | 11.9 | 2.180 | 55.4 |

| Dimensions for Style 3 | | | | | | | | | | |
|------------------------|-------|-------|-------|-------|-------|-------|-------|-------|-------|-------|
| Shell Size | A Ref | | B Ref | | C | | D Max | | E Max | |
| | In. | mm. | In. | mm. | In. | mm. | In. | mm. | In. | mm. |
| 09 | .328 | 8.33 | .805 | 20.45 | .565 | 14.35 | .453 | 11.51 | .930 | 23.62 |
| 15 | .328 | 8.33 | .955 | 24.26 | .715 | 18.16 | .453 | 11.51 | 1.080 | 27.43 |
| 21 | .328 | 8.33 | 1.105 | 28.07 | .865 | 21.97 | .453 | 11.51 | 1.230 | 31.24 |
| 25 | .328 | 8.33 | 1.205 | 30.61 | .965 | 24.51 | .453 | 11.51 | 1.330 | 33.78 |
| 31 | .328 | 8.33 | 1.355 | 34.42 | 1.115 | 28.32 | .453 | 11.51 | 1.480 | 37.59 |
| 37 | .328 | 8.33 | 1.505 | 38.23 | 1.265 | 32.13 | .453 | 11.51 | 1.630 | 41.40 |
| 51 | .371 | 9.42 | 1.455 | 36.96 | 1.215 | 30.86 | .496 | 12.60 | 1.580 | 40.13 |
| 51-2* | .328 | 8.33 | 1.855 | 47.12 | 1.615 | 41.02 | .453 | 11.51 | 1.980 | 50.29 |
| 67 | .328 | 8.33 | 2.255 | 57.28 | 2.015 | 51.18 | .453 | 11.51 | 2.380 | 60.45 |
| 69* | .371 | 9.42 | 1.755 | 44.58 | 1.515 | 38.48 | .496 | 12.60 | 1.880 | 47.75 |
| 100 | .414 | 10.52 | 2.190 | 55.63 | 1.800 | 45.72 | .539 | 13.69 | 2.315 | 58.80 |

| Style 3 Rear Mounted Dash No. | | | |
|-------------------------------|------|-----|-----------------|
| Dash No | F | | Panel Thickness |
| | In. | mm. | |
| R1 | .126 | 3.2 | .031 |
| R2 | .110 | 2.8 | .047 |
| R3 | .095 | 2.4 | .062 |
| R4 | .064 | 1.6 | .093 |



Metal Protective Covers with Silicone Rubber Gaskets 500-107



Choose Metal Protective Covers for full environmental protection.

Silicone Rubber Gasket provides a watertight seal.

| How To Order Metal Protective Covers | | 500-107 | J | 31 | P | B | N | 5 | 01 |
|--------------------------------------|---|------------|--|--|---|---|---|---|----|
| Sample Part Number | | | | | | | | | |
| Series | 500-107 | | | | | | | | |
| Shell Finish | B - Cadmium Plate/Olive Drab E - Chem Film M - Electroless Nickel R - Red Anodized Z1 - Stainless Steel/Passivate ME - Electroless Nickel, Grade A | | C - Black Anodize J - Cadmium, Yellow Chromate NF - Cadmium, Olive Drab Y - Gold Iridite Over Cadmium Plate Z2 - Gold Plate | | | | | | |
| Connector Size | 9, 15, 21, 25, 31, 37, 51, 51-2, 67, 69, 100 (See Table I) | | | | | | | | |
| Style | P - Dust Cover for Plug | | R - Dust Cover for Receptacle (See Table II) | | | | | | |
| Hardware | B - No Hardware (Ø.093) S - Slotted Jackscrew M1 - Extended Hexhead Jackscrew L - Hexhead Non-Removable Jackscrew | | M - Hexhead Jackscrew P - Female Jackpost S1 - Extended Slotted Jackscrew K - Extended Non-Removable Jackscrew | | | | | | |
| Attachment Type | F - Wire Rope, Nylon Jacket N - No Lanyard Attachment R - Wire Rope, PVC Jacket G - Flexible Nylon Rope | | H - Wire Rope, Fluoropolymer Jacket NB - No Lanyard Or Attachment Boss T - Wire Rope, No Jacket | | | | | | |
| Attachment Length (Inches) | Length in One Inch Increments; Example: "6" equals six inches. | | | | | | | | |
| Attachment Diameter | 01 - .140 (3.6) | 02 - 0.182 | 03 - 0.191 | 04 - .197 (5.0) 05 - .167 (4.2) 06 - .125 (3.2) I.D. of Ring Terminal | | | | | |

Table I: Select A Protective Cover Style



Notes

1. Assembly identified with manufacturer's name and p/n, space permitting.
2. Material/finish:
Backshell - see How To Order Table
Hardware - cres/passivated
Attachment - see How To Order Table
Gasket - silicone/N.A.
3. Attachment to withstand 25 lb min. Pull test.

N

**Metal Protective Covers
with Silicone Rubber Gaskets
500-107**



Table II: Dimensions



Style R
Dust Cover For Receptacle



Style P
Dust Cover For Plug



| Layout | A Max | B ±.003 | C Max | D Max | E Max |
|--------|-------|---------|-------|-------|-------|
| 9R | 0.785 | 0.565 | 0.333 | 0.184 | 0.308 |
| 9P | 0.785 | 0.565 | 0.400 | 0.250 | 0.308 |
| 15R | 0.935 | 0.715 | 0.483 | 0.184 | 0.308 |
| 15P | 0.935 | 0.715 | 0.551 | 0.250 | 0.308 |
| 21R | 1.085 | 0.865 | 0.633 | 0.184 | 0.308 |
| 21P | 1.085 | 0.865 | 0.701 | 0.250 | 0.308 |
| 25R | 1.185 | 0.965 | 0.733 | 0.184 | 0.308 |
| 25P | 1.185 | 0.965 | 0.801 | 0.250 | 0.308 |
| 31R | 1.335 | 1.115 | 0.883 | 0.184 | 0.308 |
| 31P | 1.335 | 1.115 | 0.951 | 0.250 | 0.308 |
| 37R | 1.485 | 1.265 | 1.033 | 0.184 | 0.308 |
| 37P | 1.485 | 1.265 | 1.101 | 0.250 | 0.308 |
| 51R | 1.435 | 1.215 | 0.983 | 0.228 | 0.351 |
| 51P | 1.435 | 1.215 | 1.051 | 0.296 | 0.351 |
| 51-2R | 1.835 | 1.615 | 1.384 | 0.184 | 0.308 |
| 51-2P | 1.835 | 1.615 | 1.450 | 0.250 | 0.308 |
| 67R | 2.235 | 2.015 | 1.784 | 0.184 | 0.310 |
| 67P | 2.235 | 2.015 | 1.850 | 0.250 | 0.310 |
| 69R | 1.735 | 1.515 | 1.284 | 0.228 | 0.351 |
| 69P | 1.735 | 1.515 | 1.350 | 0.296 | 0.351 |
| 100R | 2.170 | 1.800 | 1.383 | 0.270 | 0.394 |
| 100P | 2.170 | 1.800 | 1.451 | 0.333 | 0.394 |



"Marshall Bean" Protective Rubber Covers with Tether Rope 780-555



Fits Metal Shell
M83513 Type
Connectors

Rubber Covers for Tactical Equipment and Field Instruments

– These friction-fit covers provide dust and splash protection.

Two Tether Styles – Choose ring terminals for attachment to a panel, or choose slip knots for cable attachment.
-55° to +125° Temperature Range

| Materials & Finishes | |
|----------------------|----------------------------------|
| Cover | SBR Rubber Per ASTM D2000 Type C |
| Ring Terminal | Stainless Steel |
| Crimp Ring | Copper, Black Oxide Finish |

How To Order Rubber Protective Covers

| Sample Part Number | 780-555 | 37P | G | 4 | -SK | C |
|--------------------|--|-----|---|---|-----|---|
| Series | 780-555 | | | | | |
| Connector Layout | 9P, 15P, 21P, 25P, 31P, 37P, 51P, 51-2P, 67P, 69P, 100P 9S, 15S, 21S, 25S, 31S, 37S, 51S, 51-2S, 67S, 69S, 100S | | | | | |
| Nylon Cord Option | Omit - (leave blank) Cover only, no cord G - Nylon Cord | | | | | |
| Nylon Cord Length | Length in One Inch Increments; Example: "6" equals six inches ± .250 (6.35) Inches | | | | | |
| Attachment Option | Ring Terminal 06 - .125 (3.2) I.D. 01 - .140 (3.6) I.D. 05 - .167 (4.2) I.D. 04 - .197 (5.0) I.D. SK - Slip Knot | | | | | |
| Rubber Type | Omit - Standard Rubber C - Conductive Rubber | | | | | |

Dimensions



| Layout | A Max. | | B Max. | | Layout | A Max. | | B Max. | |
|----------|--------|-------|--------|------|--------------|--------|-------|--------|-------|
| | In. | mm. | In. | mm. | | In. | mm. | In. | mm. |
| 9P, 9S | .830 | 21.08 | .370 | 9.40 | 51P, 51S | 1.480 | 37.59 | .410 | 10.41 |
| 15P, 15S | .980 | 24.89 | .370 | 9.40 | 51-2P, 51-2S | 1.880 | 47.75 | .370 | 9.40 |
| 21P, 21S | 1.130 | 28.70 | .370 | 9.40 | 67P, 67S | 2.770 | 70.36 | .370 | 9.40 |
| 25P, 25S | 1.230 | 31.24 | .370 | 9.40 | 69P, 69S | 1.780 | 45.21 | .410 | 10.41 |
| 31P, 31S | 1.380 | 35.05 | .370 | 9.40 | 100P, 100S | 2.215 | 56.26 | .460 | 11.68 |
| 37P, 37S | 1.530 | 38.86 | .370 | 9.40 | | | | | |

Standard material contains trace amounts of sulfur (a vulcanizing agent) which is known to contribute to degradation/corrosion of silver plated components such as braid, etc. Specify MOD Code suffix -675 for sulfur-free material.

Stainless Steel Jackscrew Kits with E-Rings 080-00-00-5XX



Mil Spec Jackscrew Kits feature 300 series stainless steel and easily attach to Micro-D connectors with an e-ring.

Order One Kit Per Connector Each kit contains two jackscrews and e-rings.

| Mil Spec Jackscrew Kits | | | | |
|--|---|----------------------|---------------------|---|
| Configuration | Connector Size, Thread Size | Part Number | | Dimensions |
| | | Mil Spec Part Number | Glenair Part Number | |
|  Hex Head Low Profile | Sizes 9 to 69 Contacts. Mil Spec Size A to G #2-56 UNC-2A | M83513/05-02 | 080-00-00-502 |  <p>.062 (1.57) HEX .125 (3.18) DIA .103 (2.62) MAX .083 (2.11) DIA #2-56 UNC 2A .090 (2.29) MIN PERFECT THD .258 (6.55) MAX</p> |
| | Sizes 75-130 Mil Spec Size H #4-40 UNC-2A | M83513/05-12 | 080-00-00-512 |  <p>.062 (1.57) HEX .187 (4.75) DIA .098 (2.49) .140 (3.56) DIA #4-40 UNC 2A .110 (2.79) MIN PERFECT THD .292 (7.41) MAX</p> |
|  Slot Head Low Profile | Sizes 9 to 69 Contacts. Mil Spec Size A to G #2-56 UNC-2A | M83513/05-05 | 080-00-00-505 |  <p>.083 (2.11) DIA .125 (3.18) DIA .103 (2.62) MAX #2-56 UNC 2A .090 (2.29) MIN PERFECT THD .258 (6.55) MAX</p> |
| | Sizes 75-130 Mil Spec Size H #4-40 UNC-2A | M83513/05-15 | 080-00-00-515 |  <p>.140 (3.56) DIA .187 (4.75) DIA .098 (2.49) #4-40 UNC 2A .110 (2.79) MIN PERFECT THD .292 (7.41) MAX</p> |
|  Hex Head Extended | Sizes 9 - 69 Contacts. Mil Spec Size A to G #2-56 UNC-2A | M83513/05-03 | 080-00-00-503 |  <p>.156 (3.96) DIA MAX .062 (1.57) HEX .610 (15.49) MAX .083 (2.11) DIA #2-56 UNC 2A .090 (2.29) MIN PERFECT THD .258 (6.55) MAX</p> |
| | Sizes 75-130 Mil Spec Size H #4-40 UNC-2A | M83513/05-13 | 080-00-00-513 |  <p>.200 (5.08) DIA MAX .062 (1.57) HEX .610 (15.49) MAX .140 (3.56) DIA #4-40 UNC 2A .110 (2.79) MIN PERFECT THD .292 (7.41) MAX</p> |
|  Slot Head Extended | Sizes 9-69 Contacts. Mil Spec Size A to G #2-56 UNC-2A | M83513/05-06 | 080-00-00-506 |  <p>.156 (3.96) DIA MAX .610 (15.49) MAX .083 (2.11) DIA #2-56 UNC 2A .090 (2.29) MIN PERFECT THD .258 (6.55) MAX</p> |
| | Sizes 75-130 Mil Spec Size H #4-40 UNC-2A | M83513/05-16 | 080-00-00-516 |  <p>.200 (5.08) DIA MAX .610 (15.49) MAX .140 (3.56) DIA #4-40 UNC 2A .110 (2.79) MIN PERFECT THD .292 (7.41) MAX</p> |





Stainless Steel Jackscrew Kits with C Clips 179-013-XX



C Clip Jackscrew Kits offer an alternative to e-ring jack screw kits. The c clip fits over the flange and, unlike e-rings, cannot be dislodged in handling or use.

Corrosion-Resistant Steel – The clip is made from 17-7PH spring temper stainless steel. The jackscrew is made from 125 KPSI tensile strength stainless steel, passivated.

Order Two Kits Per Connector. Each kit consists of one jackscrew and one c clip.

Application Note: The magnetic permeability of the c clip exceeds the 2.0 μ maximum of MIL-DTL-83513.



Figure 1

C Clip for Size 9 - 69 Pin Micro-D



Figure 2

C Clip for Sizes 75-130 Micro-D

| Part Number | Jackscrew Type | Thread Size | Configuration | Recommended Max. Torque | Max. Weight In Grams (2 Kits) |
|-------------|----------------|-------------|---------------|-------------------------|-------------------------------|
| 179-013-1S | Slot Head | #2-56 UNC | Figure 1 | 2.5 inch-pounds | 1.0 |
| 179-013-1H | Hex head | #2-56 UNC | Figure 1 | 2.5 inch-pounds | 1.0 |
| 179-013-2S | Slot Head | #4-40 UNC | Figure 2 | 4.0 inch-pounds | 1.5 |
| 179-013-2H | Hex head | #4-40 UNC | Figure 2 | 4.0 inch-pounds | 1.5 |

Replacement Hardware Kits for C Clip Micro-D Backshells



Replacement Hardware Kits for Standard Series 50 Micro-D Backshells.

Order Two Kits Per Connector. Each Jackscrew kit consists of one jackscrew and one "C" clip.

Corrosion-Resistant Steel – The clip is made from 17-7PH spring temper stainless steel. The jackscrew is made from 300 series stainless steel, passivated.

| Fillister Head Jackscrew | | Hex Head Jackscrew | | Extended Jackscrew | | Jackpost | |
|--------------------------|--------------------|--------------------|--------------------|-----------------------------|----------------|------------------|--------------------|
| Part Number | Thread Size | Part Number | Thread Size | Part Number (dash # = size) | Overall Length | Part Number | Thread Size |
| 687-152-01B | #2-56 (9-69 pin) | 687-152-01 | #2-56 (9-69 pin) | 687-439-09 | 1.27 (32.3) | 687-194 | #2-56 (9-69 pin) |
| 687-152-02B | #4-40 (75-130 pin) | 687-152-02 | #4-40 (75-130 pin) | 687-439-15 | 1.40 (35.6) | 687-194-1 | #4-40 (75-130 pin) |
| | | | | 687-439-21 | 1.52 (38.6) | | |
| | | | | 687-439-25 | 1.58 (40.1) | | |
| | | | | 687-439-31 | 1.64 (41.7) | | |
| | | | | 687-439-37 | 1.68 (42.7) | | |
| | | | | 687-439-51 | 1.71 (43.3) | | |
| | | | | 687-439-100 | 1.81 (46.0) | | |

Stainless Steel Jackpost Kits

Standard Hex, Rear Panel or Rear Panel PCB

080-00-00-1XX, 500-069-X-X, 177-504-X-X and 177-505-X-X-X



Rear Panel Mount
Micro-D Jackpost



Micro-D Jackpost Kits feature 300 series stainless steel. Select a style: standard hex posts, rear panel, or rear panel printed circuit board.

Order One Kit Per Connector. Each kit contains two jackposts.

Jackpost General information

1. Material and Finish: Corrosion resistant steel in accordance with ASTM A484 and ASTM A582, passivated in accordance with ASTM A967.
2. Mounting Torque: #2-56 threads= 3.0 - 4.0 inch-pounds, #4-40 threads = 5.0 - 6.0 inch-pounds. Mating Torque: #2-56 threads= 1.0 - 2.5 inch-pounds, #4-40 threads = 3.5 - 4.0 inch-pounds. Maximum recommended torque for installation and operation.
3. Standard Package: One kit consists of two jackposts, 2 washers and 2 nuts for styles 1 and 2. Style 3 kits contain two jackposts. One kit per bag.
4. Application: Style 1 and 2 jackposts are compatible with any standard Micro-D connector. Style 3 jackposts for rear panel mounting Glenair printed circuit board connectors types BS, BR, and CBR only.

Select a Jackpost Style

| Style 1 | Style 2 | Style 3 |
|--|--|--|
| | | |
| Use With Standard Solder Cup or Pigtail Micro-D Connectors | Use With Rear Panel Mounted Solder Cup or Pigtail Micro-D Connectors | Use With Rear Panel Mounted Printed Circuit Board Micro-D Connectors |

Style 1 Jackpost Kits

Style 1 Jackpost Kits are standard kits for installation on all standard Micro-D connectors. Each kit contains two jackposts, two hex nuts and two lockwashers.

| Connector Sizes (THDS) | Mil Spec Part Number | Glenair Part Number | A Length | | Figure |
|--|----------------------|---------------------|------------|-----------|----------|
| | | | In. ± .015 | mm. ± 0.4 | |
| 9 — 69 M83513 sizes A thru G (#2-56) | M83513/05-07 | 080-00-00-100 | .475 | 12.1 | Figure 1 |
| | | 500-069-2-1 | .688 | 17.5 | |
| | | 500-069-2-2 | .813 | 20.7 | |
| | | 500-069-2-3 | .938 | 23.8 | |
| | | 500-069-2-4 | 1.063 | 27.0 | |
| 75-130 M83513 size H (#4-40) | M83513/05-17 | 080-00-00-101 | .475 | 12.1 | Figure 2 |
| | | 500-069-4-1 | .680 | 17.3 | |
| | | 500-069-4-2 | .805 | 20.4 | |
| | | 500-069-4-3 | .930 | 23.6 | |
| | | 500-069-4-4 | 1.055 | 26.8 | |
| | | 500-069-4-5 | 1.180 | 30.3 | |



Figure 1
#2-56 Jackpost



Figure 2
#4-40 Jackpost



Stainless Steel Jackpost Kits

Standard Hex, Rear Panel or Rear Panel PCB

080-00-00-1XX, 500-069-X-X, 177-504-X-X and 177-505-X-X-X

Style 2 Jackpost Kits For Rear Mounted Connectors

Style 2 Jackpost Kits are for rear panel mounted connectors. These round, slotted posts accommodate panel thickness from .031 inches (0.8 mm.) to .125 inches (3.2 mm.).

| Connector Size (THDS) | Panel Thickness | | Part Number | A | | Figure |
|---|-----------------|-----|-------------|------------|------------|----------|
| | In. | mm | | In. ± .003 | mm. ± 0.08 | |
| 9 — 69 M83513 sizes A thru G (#2-56) | .031 | 0.8 | 177-504-2-2 | .024 | 0.61 | Figure 1 |
| | .047 | 1.2 | 177-504-2-3 | .041 | 1.04 | |
| | .062 | 1.6 | 177-504-2-4 | .055 | 1.40 | |
| | .094 | 2.4 | 177-504-2-5 | .086 | 2.18 | |
| | .125 | 3.2 | 177-504-2-6 | .118 | 3.00 | |
| | .080 | 2.0 | 177-504-2-7 | .073 | 1.85 | |
| 75-130 M83513 size H (#4-40) | .031 | 0.8 | 177-504-4-2 | .024 | 0.61 | Figure 2 |
| | .047 | 1.2 | 177-504-4-3 | .041 | 1.04 | |
| | .062 | 1.6 | 177-504-4-4 | .055 | 1.40 | |
| | .094 | 2.4 | 177-504-4-5 | .086 | 2.18 | |
| | .125 | 3.2 | 177-504-4-6 | .118 | 3.00 | |
| | .080 | 2.0 | 177-504-4-7 | .073 | 1.85 | |



Style 3 Jackpost Kits For Printed Circuit Board Connectors

Style 3 Jackpost Kits are for rear panel mounted PCB connectors. Select the right post by choosing the connector style (BS, BR and CBR are the three standard PCB connector configurations).

| Connector Size (THDS) | Connector Style, Overall Length | Panel Thickness | | Part Number | A | | Figure |
|---|---------------------------------|-----------------|-----|---------------|------------|------------|----------|
| | | In. | mm. | | In. ± .003 | mm. ± 0.08 | |
| 9 — 69 M83513 sizes A thru G (#2-56) | BS, CBR .365 (9.3) OAL | .031 | 0.8 | 177-505-A-2-2 | .024 | 0.61 | Figure 1 |
| | | .047 | 1.2 | 177-505-A-2-3 | .041 | 1.04 | |
| | | .062 | 1.6 | 177-505-A-2-4 | .055 | 1.40 | |
| | | .094 | 2.4 | 177-505-A-2-5 | .086 | 2.18 | |
| | | .125 | 3.2 | 177-505-A-2-6 | .118 | 3.00 | |
| | | .080 | 2.0 | 177-505-A-2-7 | .073 | 1.85 | |
| | BR .398 (10.1) OAL | .031 | 0.8 | 177-505-B-2-2 | .024 | 0.61 | |
| | | .047 | 1.2 | 177-505-B-2-3 | .041 | 1.04 | |
| | | .062 | 1.6 | 177-505-B-2-4 | .055 | 1.40 | |
| | | .094 | 2.4 | 177-505-B-2-5 | .086 | 2.18 | |
| | | .125 | 3.2 | 177-505-B-2-6 | .118 | 3.00 | |
| | | .080 | 2.0 | 177-505-B-2-7 | .073 | 1.85 | |
| 75-130 M83513 size H (#4-40) | BR, CBR .475 (12.1) OAL | .031 | 0.8 | 177-505-C-4-2 | .024 | 0.61 | Figure 2 |
| | | .047 | 1.2 | 177-505-C-4-3 | .041 | 1.04 | |
| | | .062 | 1.6 | 177-505-C-4-4 | .055 | 1.40 | |
| | | .094 | 2.4 | 177-505-C-4-5 | .086 | 2.18 | |
| | | .125 | 3.2 | 177-505-C-4-6 | .118 | 3.00 | |
| | | .080 | 2.0 | 177-505-C-4-7 | .073 | 1.85 | |
| | BS .360 (9.1) OAL | .031 | 0.8 | 177-505-D-4-2 | .024 | 0.61 | |
| | | .047 | 1.2 | 177-505-D-4-3 | .041 | 1.04 | |
| | | .062 | 1.6 | 177-505-D-4-4 | .055 | 1.40 | |
| | | .094 | 2.4 | 177-505-D-4-5 | .086 | 2.18 | |
| | | .125 | 3.2 | 177-505-D-4-6 | .118 | 3.00 | |
| | | .080 | 2.0 | 177-505-D-4-7 | .073 | 1.85 | |



For CBS Style Circuit Board Connectors—See Catalog Page C-16

METAL SHELL



EDGEBOARD AND CIRCULAR CONNECTORS

For high reliability applications



MWEB Edgeboard Features:

- Designed for motherboard-to-daughter applications
- Available in four styles: cardedge and through hole for daughtercards as well as vertical and right angle for motherboards
- Hardened versions of 128 pin and 184 pin commercial board connectors

MWKQ Circular Features:

- Designed for panel-to-cord I/O applications
- Quick-connect/disconnect capabilities
- Available in two sizes with an option of 7 or 19 contacts
- Factory terminated

Glenair[®]

Glenair, Inc.

1211 Air Way
Glendale, CA
91201-2497

818-247-6000
sales@glenair.com
www.glenair.com

Rugged Mil-Spec Performance in a High Density Backplane Connector: The MWEB Edgeboard



MWEB EdgeBoard
Connectors
Page G-2

MWEB EdgeBoard Connectors

These two row .050 inch (1.27 mm) pitch connectors are designed for motherboard-to-daughtercard applications. Available in four styles: surface mount cardedge for daughtercards, vertical thru-hole for motherboards, right angle thru-hole for daughtercards, and prewired cable connectors, these MWEB connectors feature rugged aluminum shells and TwistPin contacts. The single gang 128 pin and the two gang 184 pin (2 X 92 pin) are a ruggedized alternative to commercial board connectors.

MWKQ Micro Circular Connectors Feature Quick coupling and Quick Release

MWKQ Micro Circular Connectors

The MWKQ connector provides quick-disconnect capability combined with a high performance contact system and rugged construction. Intended for panel-to-cord I/O applications, these connectors are found in tactical military equipment, weapons systems and various instrumentation applications. Available in two sizes with 7 or 19 contact, the MWKQ is factory-terminated to the wire of your choice. Shielded, overmolded cordsets and other custom versions are available.



MWKQ Series
19P Panel Mount
Receptacle

MWKQ Series
19S Cable Plug

Page P-13



D38999
19 Contacts

Glenair Series 80
19 Contacts

MWKQ Series
19 Contacts

Glenair Nano
19 Contacts

*The Glenair Series 89 Nanominiature Connectors Catalog is available online at www.glenair.com



Industry-Standard, Approved for Airborne Computers

MWEB EdgeBoard connectors meet the requirements of MIL-DTL-55302/120 thru /123. Available with 128 or 184 contacts.

Rugged Aluminum Shell and TwistPin Contacts

MWEB connectors share the same design and construction as the Glenair Micro-D M83513 connector.

Backplane, Daughtercard and Wired

Vertical mount thru-hole motherboard connectors and straddle mount daughtercard connectors are complemented by right angle thru-hole and pre-wired I/O versions.

Rugged Mil Spec Performance in a High-Density Backplane Connector System: The MWEB EdgeBoard

Featuring a width of only $\frac{1}{4}$ inch (6.4 mm.), MWEB Series connectors provide high-density in a rugged metal shell connector. Contacts are rated at 3 amps, and the DWV voltage rating is 150 volts AC RMS at 70,000 feet altitude. The two row, .050 inch (1.54 mm.) spacing is made possible by using TwistPin reverse gender contacts. Insert-molded LCP insulators are resistant to heat and chemicals. Contacts are beryllium copper with fifty microns of gold plating. Shells are machined aluminum alloy. Hexagonal polarizing keys allow up to 36 keying options.



Vertical Mount Backplane Connector MWEB-128P



MWEB-128P Backplane Thru-Hole Connector

Part Number MWEB2L-128P5W4-.375

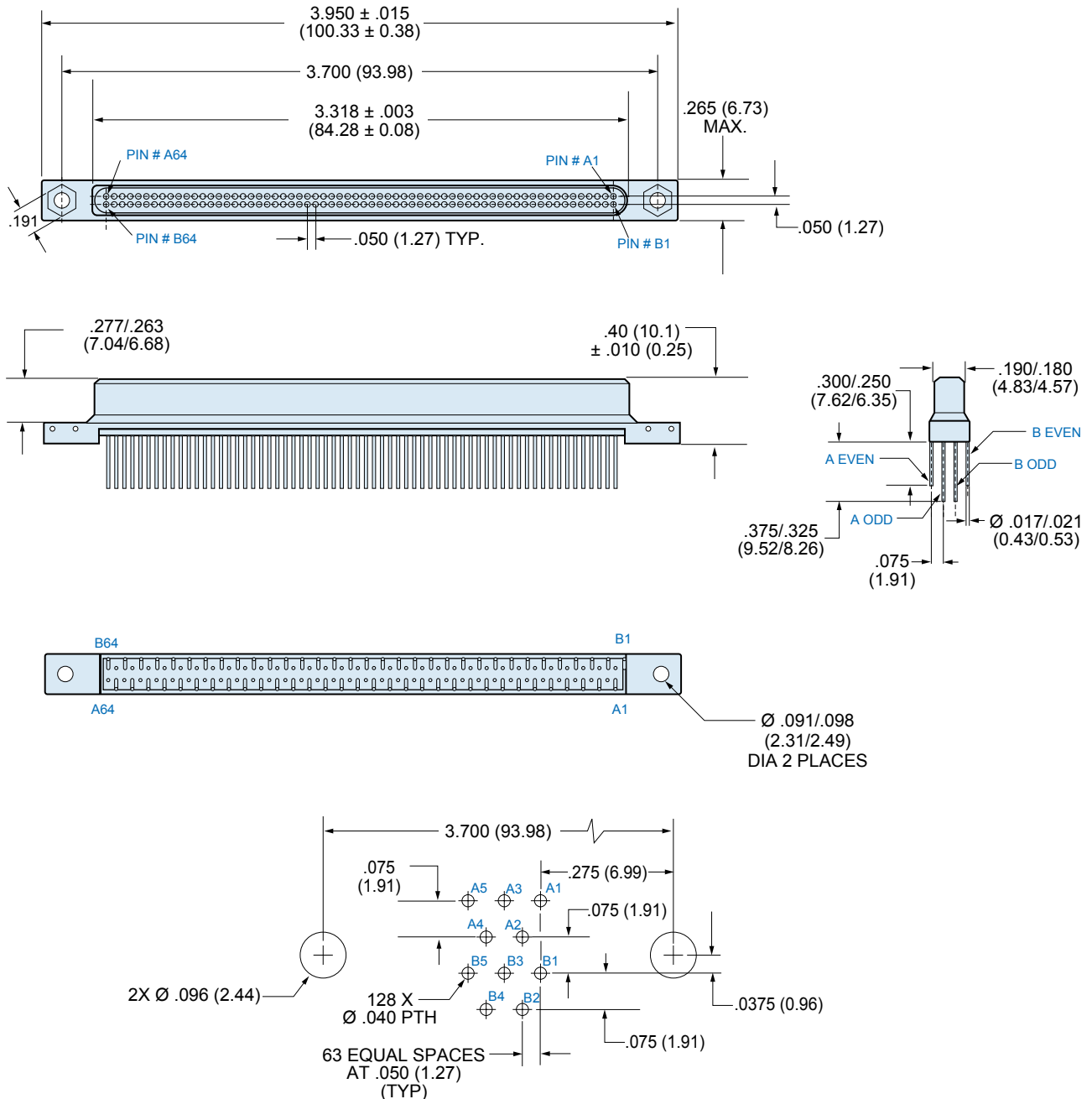

PATTERN SHOWN IS FOR CONNECTOR
MOUNTING SIDE OF PC BOARD

MWEB-128S Straddle Mount Cardedge Connector

Part Number MWEB2L-128S4BS3



P

Right Angle Board Connectors MWEB-128S



MWEB-128S Right Angle PCB Connector

MWEB2L-128SBR-.125

Base Part Number

PC Tail Length

- .090
- .125
- .190
- .250



CONNECTOR MATING FACE THIS SIDE



Straddle Mount Card-Edge Connector MWEB-184S



MWEB-184S Straddle Mount Cardedge Connector

Part Number MWEB2L-184NS4BS3





Right Angle Board Connector MWEB-184S

MWEB-184S Right Angle PCB Connector

Base Part Number MWEB2L-184NSBR- .125

PC Tail Length
 .090
 .125
 .190
 .250



PATTERN SHOWN IS FOR CONNECTOR MOUNTING SIDE OF PC BOARD

P

MWEB Pre-Wired and Solder Cup Connectors MWEB2L



MWEB EdgeBoard Connectors For Input/Output Wire-To-Board Applications

With 128 or 184 contacts, these narrow profile factory-terminated MWEB connectors provide a space-saving I/O wire to board solution. Connector width of .25 inch (6.4 mm.) allows for high-density card slots.

High Performance TwistPin Contacts

Suitable for airborne avionics processors and mission-critical computers, these pre-wired connectors feature interfacial seals and backpotting for improved environmental protection. Or, choose solder cup connectors for integration into wire harnesses.

How To Order MWEB Pigtail Connectors

| | | | | | | | | |
|---------------------------|---|------|---|----|---|---|-----|---|
| Sample Part Number | MWEB2L | -128 | P | -6 | K | 7 | -18 | N |
| Series | MWEB2L | | | | | | | |
| Connector Layout | 128, 184N | | | | | | | |
| Contact Type | P - Pin S - Socket | | | | | | | |
| Wire Gage (AWG) | 4 - #24 6 - #26 8 - #28 0 - #30 | | | | | | | |
| Wire Type | K - M22759/11 600 VRMS Fluoropolymer (TFE) J - M22759/33 600 VRMS Modified Cross-Linked Tefzel® (ETFE) | | | | | | | |
| Wire Color | 1 - White 2 - Yellow 7 - Ten Color Repeating | | | | | | | |
| Wire Length Inches | 18 - Total Length In Inches. "18" Specifies 18 Inches. | | | | | | | |
| Hardware Option | N - No hardware | | | | | | | |

How To Order MWEB Solder Cup Connectors

| | | | | | |
|---------------------------|--------------------|------|---|---|---|
| Sample Part Number | MWEB2L | -128 | P | S | N |
| Series | MWEB2L | | | | |
| Connector Layout | 128, 184N | | | | |
| Contact Type | P - Pin S - Socket | | | | |
| Termination Type | S - Solder Cup | | | | |
| Hardware Option | N - No Hardware | | | | |



MWKQ2L6 Quick Disconnect Micro Circular Connectors Plug Connectors



**Plug With Socket
Contacts**



**Receptacle With
Pin Contacts**

MWKQ Micro Circular Connectors feature quick coupling and quick release. The plug has a knurled release sleeve. To unmate, just pull back on the sleeve, compressing the locking ring and free it from the receptacle.

Choose (7) or (19) Contacts – Connectors are supplied with hookup wires installed and potted.

How To Order Plug (Socket) Connectors

| | | | | | | | |
|---------------------------|---|------------|----------|-----------|----------|----------|------------|
| Sample Part Number | MWKQ2L6 | -19 | S | -6 | K | 7 | -24 |
| Series | MWKQ2L6 | | | | | | |
| No. of Contacts | 7, 19 (See Table I and II) | | | | | | |
| Contact Type | S - Socket | | | | | | |
| Wire Gage (AWG) | 4 - #24 6 - #26 8 - #28 0 - #30 | | | | | | |
| Wire Type | K - M22759/11 600 Vrms Fluoropolymer (TFE) J - M22759/33 600 Vrms Modified Cross-Linked Fluoropolymer (ETFE) | | | | | | |
| Wire Color | 1 - White 2 - Yellow 5 - Color Coded Striped Wire Per MIL-STD-681 7 - Ten Color Repeating | | | | | | |
| Wire Length Inches | 18 - Total Length In Inches. "18" Specifies 18 Inches. | | | | | | |

Table I: Contact Arrangements

| | | | |
|---|--|--|---|
| | | | |
| 7 Contacts Face View Pin Connector (Receptacle) | 7 Contacts Face View Socket Connector (Plug) | 19 Contacts Face View Pin Connector (Receptacle) | 19 Contacts Face View Socket Connector (Plug) |

MWKQ2L7 MWKQ2L8 and MWKQ2L9 Quick Disconnect Micro Circular Connectors Receptacle Connectors, Inline, Front and Rear Mount



How To Order Receptacle (Pin) Connectors

| | | | | | | | |
|---------------------------|---|-----------|----------|-----------|----------|----------|------------|
| Sample Part Number | MWKQ2L7 | -7 | P | -6 | K | 7 | -24 |
| Series | MWKQ2L7 | | | | | | |
| No. of Contacts | 7, 19 (See Table I and II) | | | | | | |
| Contact Type | P - Pin | | | | | | |
| Wire Gage (AWG) | 4 - #24 6 - #26 8 - #28 0 - #30 | | | | | | |
| Wire Type | K - M22759/11 600 Vrms Fluoropolymer (TFE) J - M22759/33 600 Vrms Modified Cross-Linked Fluoropolymer (ETFE) | | | | | | |
| Wire Color | 1 - White 2 - Yellow 7 - Ten Color Repeating | | | | | | |
| Wire Length Inches | 18 - Total Length In Inches. "18" Specifies 18 Inches. | | | | | | |

How To Order Receptacle (Pin) Connectors

| | | | | | | | |
|---------------------------|---|-----------|----------|-----------|----------|----------|------------|
| Sample Part Number | MWKQ2L8 | -7 | P | -6 | K | 7 | -18 |
| Series | MWKQ2L8 | | | | | | |
| No. of Contacts | 7, 19 (See Table I and III) | | | | | | |
| Contact Type | P - Pin | | | | | | |
| Wire Gage (AWG) | 4 - #24 6 - #26 8 - #28 0 - #30 | | | | | | |
| Wire Type | K - M22759/11 600 Vrms Fluoropolymer (TFE) J - M22759/33 600 Vrms Modified Cross-Linked Fluoropolymer (ETFE) | | | | | | |
| Wire Color | 1 - White 2 - Yellow 5 - Color Coded Striped Wire Per MIL-STD-681 7 - Ten Color Repeating | | | | | | |
| Wire Length Inches | 18 - Total Length In Inches. "18" Specifies 18 Inches. | | | | | | |

How To Order Receptacle (Pin) Connectors

| | | | | | | | |
|---------------------------|---|-----------|----------|-----------|----------|----------|------------|
| Sample Part Number | MWKQ2L9 | -7 | P | -6 | K | 7 | -18 |
| Series | MWKQ2L9 | | | | | | |
| No. of Contacts | 7, 19 (See Table I and III) | | | | | | |
| Contact Type | P - Pin | | | | | | |
| Wire Gage (AWG) | 4 - #24 6 - #26 8 - #28 0 - #30 | | | | | | |
| Wire Type | K - M22759/11 600 Vrms Fluoropolymer (TFE) J - M22759/33 600 Vrms Modified Cross-Linked Fluoropolymer (ETFE) | | | | | | |
| Wire Color | 1 - White 2 - Yellow 7 - Ten Color Repeating | | | | | | |
| Wire Length Inches | 18 - Total Length In Inches. "18" Specifies 18 Inches. | | | | | | |



Quick Disconnect Micro Circular Connectors MWKQ2L6 and MWKQ2L7

| Performance Specifications | |
|---------------------------------|--|
| Current Rating | 3 AMP |
| Dielectric Withstanding Voltage | 600 VAC Sea Level 150 VAC 70,000 Feet |
| Insulation Resistance | 5000 Megohms Minimum |
| Contact Resistance | 8 Milliohms Maximum |
| Low Level CR | 32 Milliohms Maximum |
| Operating Temperature | -55° C. to +150° C. |
| Shock | 50 g. |
| Vibration | 20 g. |
| Mating Force | (10 Ounces) X (# of Contacts) |

| Materials and Finishes | |
|------------------------|---|
| Connector Shell, | Aluminum Alloy 6061 with Electroless Nickel Plating |
| Release Sleeve | Brass with Electroless Nickel Plating |
| Insulator | Liquid Crystal Polymer (LCP) |
| Lock Ring & Jam Nut | Stainless Steel |
| Pin Contact | Beryllium Copper With 50 Microinches Gold over Nickel Plating |
| Socket Contact | Copper Alloy With 50 Microinches Gold Over Nickel Plating |
| Encapsulant | Epoxy Resin Hysol EE4215 |

Table II: Dimensions



PLUG CONNECTOR MWKQ2L6



FRONT PANEL MOUNT RECEPTACLE CONNECTOR MWKQ2L7

| Layout | A Max. | | B Max. | | C Max. | | D Hex. | | E Thds. | F | | G Dia. | |
|--------|--------|-------|--------|-------|--------|-------|--------|-------|------------------|---------------|---------------|--------|-------|
| | In. | mm. | In. | mm. | In. | mm. | In. | mm. | | In. ± .005 | mm. ± 0.13 | In. | mm. |
| 7 | .385 | 9.78 | .305 | 7.75 | .500 | 12.7 | .500 | 12.70 | .3125-32 UNEF-2A | .364 | 9.25 | .390 | 9.91 |
| 19 | .515 | 13.08 | .405 | 10.28 | .570 | 14.48 | .625 | 15.88 | .500-28 UNEF-2A | .475 | 12.07 | .515 | 13.08 |

Quick Disconnect Micro Circular Connectors MWKQ2L8 and MWKQ2L9



| Performance Specifications | |
|---------------------------------|--|
| Current Rating | 3 AMP |
| Dielectric Withstanding Voltage | 600 VAC Sea Level 150 VAC 70,000 Feet |
| Insulation Resistance | 5000 Megohms Minimum |
| Contact Resistance | 8 Milliohms Maximum |
| Low Level CR | 32 Milliohms Maximum |
| Operating Temperature | -55° C. to +150° C. |
| Shock | 50 g. |
| Vibration | 20 g. |
| Mating Force | (10 Ounces) X (# of Contacts) |

| Materials and Finishes | |
|------------------------|---|
| Connector Shell, | Aluminum Alloy 6061 with Electroless Nickel Plating |
| Insulator | Liquid Crystal Polymer (LCP) |
| Lock Ring & Jam Nut | Stainless Steel |
| Pin Contact | Beryllium Copper With 50 Microinches Gold over Nickel Plating |
| Socket Contact | Copper Alloy With 50 Microinches Gold Over Nickel Plating |
| Encapsulant | Epoxy Resin Hysol EE4215 |

Table III: Dimensions



IN LINE RECEPTACLE MWKQ2L8



REAR PANEL MOUNT RECEPTACLE CONNECTOR MWKQ2L9

| Layout | ØA Max. | | ØB Max | | C | | D Thread | E | | ØF | |
|-----------|---------|-------|--------|-------|------|-------|--------------|------|-------|------|-------|
| | In. | mm. | In. | mm. | In. | mm. | | In. | mm. | In. | mm. |
| 7 | .415 | 10.54 | .562 | 14.27 | .562 | 14.27 | 7/16-28 UNEF | .425 | 10.80 | .440 | 11.18 |
| 19 | .545 | 13.84 | .682 | 17.32 | .682 | 17.32 | 9/16-24 UNEF | .535 | 10.80 | .535 | 13.59 |

SPECIAL
APPLICATIONS

GLENAIR MICROSTRIPS™

*High reliability in a single row
small form package*



Glenair Series 171 MicroStrips™ feature a .050" high-density board-to-wire connectors with optional guide pin polarization. Ideally suited for medical equipment, avionics, instrumentation satellites and other space applications. The Microstrip™ offers an economical single row solution where space savings is a priority. The rugged, high force twistpin contact accepts up to #24 wire, the current rating is 3 Amps, the voltage is 600 Vac, with a temperature rating of -55C to +150C. MicroStrips™ are available with up to 30 contacts. Five termination styles are available: solder-cup, pre-wired, PCB, surface mount and back-to-back.



Glenair®

Glenair, Inc.

1211 Air Way
Glendale, CA
91201-2497

818-247-6000
sales@glenair.com
www.glenair.com

Section Q
Series 171 MicroStrips™
Product Selection Guide



Product Selection Guide

Solder Cup
MicroStrips™
171-001
Page Q-4



Single Row MicroStrips™ with Solder Cup Contacts

Solder cup contacts for termination to #24 to #30 solid or stranded wire. Available in 1 to 30 positions. High performance M83513 TwistPin contact system. Contacts are factory-installed, non-removable and are encapsulated with epoxy. 3 Amp, 600 Vac, -55C to +150C.

Solid Wire
MicroStrips™
171-002
Page Q-6



Single Row MicroStrips™ with Solid Wire

Factory-terminated to solid copper wire. Available in 1 to 30 positions. Optional pre-tinned leads or standard gold plated wire. High performance M83513 TwistPin contact system. Contacts are factory-installed, non-removable and are encapsulated with epoxy. 3 Amp, 600 Vac, -55C to +150C.

Pre-Wired
MicroStrips™
171-003
Page Q-7



Single Row MicroStrips™ with Insulated Stranded Wire

Factory-terminated to mil spec high-temperature wire, size #24 to #30. Available in 1 to 30 positions. High performance M83513 TwistPin contact system. Contacts are factory-installed, non-removable and are encapsulated with epoxy. 3 Amp, 600 Vac, -55C to +150C.

Right Angle PCB
.050" Spacing
171-004
Page Q-9



Single Row Right Angle PCB- .050" Board Spacing

Thru-hole mounting. Gold-plated .020" diameter right angle PC tails are on .050" centers for maximum density. Available in 1 to 30 positions. High performance M83513 TwistPin contact system. Contacts are factory-installed, non-removable and are encapsulated with epoxy. 3 Amp, 600 Vac, -55C to +150C.

Right Angle PCB
Staggered
171-005, 171-006
Page Q-9



Right Angle PCB- Staggered

Thru-hole mounting. Gold-plated .020" diameter right angle PC tails are on staggered .050" or .100" spacing between rows. Available in 1 to 30 positions. High performance M83513 TwistPin contact system. Contacts are factory-installed, non-removable and are encapsulated with epoxy. 3 Amp, 600 Vac, -55C to +150C.

Vertical Mount
PCB Headers
171-007
Page Q-9



Single Row Vertical PCB

Thru-hole mounting. Gold-plated .020" diameter PC tails are spread to .100" by .100" centers for easy placement. Available in 1 to 30 positions. High performance M83513 TwistPin contact system. Contacts are factory-installed, non-removable and are encapsulated with epoxy. 3 Amp, 600 Vac, -55C to +150C.

Surface Mount
171-008
Page Q-13



Surface Mount PCB- .050" Board Spacing

.013" diameter tails are formed to allow soldering to the surface of a PC board or flex circuit. Tails are solder-dipped in 63/37 tin-lead. Available in 1 to 30 positions. High performance M83513 TwistPin contact system. Contacts are factory-installed, non-removable and are encapsulated with epoxy. 3 Amp, 600 Vac, -55C to +150C.

Single Row Back-to-Back
MicroStrips™
171-009
Page Q-15



Single Row Back-to-Back MicroStrips™

These .050" pitch single row surface mount microstrips are available with 1 to 30 contacts. Optional guide pins provide circuit polarization. Contacts are TwistPin type and are gold-plated. Housing is molded LCP thermoplastic. Suitable for high-reliability applications where long-term resistance to fretting corrosion is a necessity. 3 A., 600 Vac, -55C to +150C.





Series 171 MicroStrips™ General Information



- High Reliability TwistPin Contact System
- #24-30 AWG Wire Size
- .050" Pitch Contact Spacing
- Solder Cup, Pre-Wired or PCB Headers
- 3 Amps, +150C, 600 Vac

Series 171 MicroStrips™ Deliver TwistPin Performance and Durability In an Economical, Space-Saving Single Row Package

Series 171 MicroStrips™ are intended for high reliability board-to-wire I/O and wire-to-wire applications. These non-environmental strips are typically used inside ruggedized equipment where moisture ingress is not a factor. The MicroStrip connector provides significant advantages compared to commercial-grade headers and jumpers. The rugged, high force twistpin contact accepts up to #24 gage wire, the current rating is 3 Amps, the voltage rating is 600 Vac, and the temperature rating is -55C to +150C. The Series 171 strip connector meets all applicable requirements of MIL-DTL-83513. Choose solder cup, pre-wired, or printed circuit board versions. A stainless steel latch provides secure coupling.



Why Choose TwistPins?

The Glenair TwistPin contact system provides a superior wire attachment compared to stamped contacts. This translates into lower long-term contact resistance—and it does so under extreme conditions of vibration, shock and high heat. Plus, TwistPin connectors offer design flexibility without the penalty of longer delivery, setup charges or minimum order quantities.

| Materials and Finishes | |
|------------------------|--------------------------------------|
| Contacts | Copper alloy, 50 µmch gold plated |
| Insulators | Liquid crystal polymer (LCP) |
| Latch | Stainless Steel |
| Guide Pin | Stainless Steel |
| Potting Compound | Epoxy |
| Insulated Wire | Per MIL-W-22759/11 and /33 |
| Solid Wire, PC Tails | Per A-A-59551, gold plated or tinned |

| Specifications | |
|---------------------------------|----------------------|
| Current Rating | 3 Amps |
| Contact Resistance | 8 milliohms maximum |
| Dielectric Withstanding Voltage | 600 Vac sea level |
| Insulation Resistance | 5000 megohms minimum |
| Operating Temperature | -55° C. to +150° C. |
| Shock | 50 g. |
| Vibration | 20 g. |

About Spring Latches, Guide Pins and Mounting Holes

Optional stainless steel latch clips provide secure mating when subjected to shock and vibration. A single center latch is suitable for most applications (Fig. 1 and Fig. 2). Dual end latches are also available (Fig. 3). The spring latch is always installed on the socket strip (Fig. 1). The latch receiver is installed on the pin strip (Fig. 2). To unmate the connectors, simply press the release tab while pulling the connectors apart. MicroStrips™ are available with stainless steel guide pins. A single guide pin provides circuit polarization. A guide pin on each end (Fig. 2) helps to align connectors when mating and prevents damage to contacts. For most applications the preferred configuration is a single center latch with no guide pins. Mounting holes are now available (Fig.3). Attach strips to circuit boards with size 0-80 screws (customer-supplied).



Figure 1

Socket Strip with Center Latch

Part Number 171-003-8S-6K7-18-PBCL

Spring latch installed in the center cavity of the socket MicroStrip. Ordering Code CL for Center Latch. This strip has 5 circuits plus one cavity for the latch and two for the guide pins, for a total of 8 cavities. Note the white paint dot on the insulator. This dot indicates position #1. The wire color code system is "10 Color Repeating". Wire #1 is black, followed by brown, red, orange, yellow, green, blue, violet, grey and white.



Figure 2

Pin Strip with Center Latch and Guide Pins at Both ends.

Part Number 171-003-8P-6K7-18-PBCL

Spring latch installed in the center cavity and guide pins installed in end cavities. This strip has five electrical circuits plus two positions for guide pins and one position for the latch for a total of eight cavities. The stainless steel guide pins are installed into the end cavities of the socket strip. The end cavities of the pin strip are opened up to accept the mating guide pins.



Figure 3

Right Angle PCB Header with End Latches and Mounting Holes.
Part Number 171-004-11P-.250-BLMH.

Latch clips installed into the end cavities of the MicroStrip. Ordering Code BL for Both end Latches. Note the mounting holes. These holes allow the strip to be attached to a circuit board. Each mounting hole requires three cavities. The board mount leads are formed into a single row on .050" centers.

About Board Mount Strips

Aerospace customers typically use MicroStrips™ for high reliability board-to-wire I/O applications. The pin strip is usually configured with right angle thru-hole PC tails. The strip is bonded to the PC board with epoxy, or attached to the board with screws installed in optional mounting holes. Surface mount and vertical mount versions are also available.

Figure 4

Right Angle Pin Strip with Staggered PC Tails, Mounting Holes and Center Latch

P/N 171-005-23P-.125-CLMH

Note that the board mounted strip has 23 cavities called out in the part number, but the mating socket strip (Fig. 1) has 17. Also note that three cavities are taken up by the mounting holes, and the position #1 white dot moves to the first electrical position.





Series 171 MicroStrips™ Single Row Strips with Solder Cups 171-001



Single Row Solder Cup MicroStrips™

These .050" pitch single row solder cup microstrips accept #26 to #30 gage wire with standard contacts and up to size #24 wire with "large bore" contacts. Contacts are factory-installed and potted. Available with 1 to 30 contacts. Optional stainless steel latching mechanism prevents de-mating. Guide pins provide circuit polarization. Contacts are twistpin type and are gold-plated. Housing is molded LCP thermoplastic. Suitable for high-reliability applications where long-term resistance to fretting corrosion is a necessity. 3 A., 600 Vac, -55C to +150C.

How To Order Solder Cup Microstrips

| How To Order Solder Cup Microstrips | | | | | | |
|---|--|--|--|---|-----------|-----------|
| Sample Part Number | 171-001 | -7 | PS | -P1 | CL | MH |
| Series | 171-001 - Single Row MicroStrip, .050" Contact Spacing, Solder Cup Contacts | | | | | |
| Number of Cavities | 1 to 30 (See Table I) Total number of cavities includes guide pins, latches and mounting holes. <i>The number of cavities equals the number of electrical circuits plus 1 cavity for each guide pin and latch, plus 6 cavities for the mounting hole option.</i> | | | | | |
| Contact Gender and Solder Cup Size | PS Pin Contacts, Size #26 Solder Cup  | SS Socket Contacts, Size #26 Solder Cup  | NS Pin Contacts, Size #24 Solder Cup  | TS Socket Contacts, Size #24 Solder Cup  | | |
| Optional Guide Pin | Omit For No Guide Pin | P1 Guide Pin in Cav. #1  | PB Guide Pin at Both Ends  | P(x) Replace (X) with guide pin location.  P3 shown above: | | |
| Optional Latch | Omit For No Latch | CL Center Latch  | | BL Latch at Both Ends  | | |
| Optional Mounting Holes | Omit For No Mounting Holes | MH Mounting Holes  | | The three cavities on each end are filled with epoxy. Two .062" (1.57mm) holes are cross-drilled to allow for attachment to a mounting surface. | | |

NOTE: when ordering "BLMH" Strip Connector allow for only 3 cavities on each end (6 total)

Series 171 MicroStrips™ Single Row Strips with Solder Cups 171-001



Table I: Dimensions



| # of Cavities | (A) | | B Max. | | C | | # of Cavities | (A) | | B Max. | | C | |
|---------------|------|-------|--------|-------|------|-------|---------------|-------|-------|--------|-------|-------|-------|
| | In. | mm. | In. | mm. | In. | mm. | | In. | mm. | In. | mm. | In. | mm. |
| 1 | - | - | .085 | 2.16 | N/A | N/A | 16 | .750 | 19.05 | .835 | 21.21 | .650 | 16.51 |
| 2 | .050 | 1.27 | .135 | 3.43 | N/A | N/A | 17 | .800 | 20.32 | .885 | 22.48 | .700 | 17.78 |
| 3 | .100 | 2.54 | .185 | 4.70 | N/A | N/A | 18 | .850 | 21.59 | .935 | 23.75 | .750 | 19.05 |
| 4 | .150 | 3.81 | .235 | 5.97 | N/A | N/A | 19 | .900 | 22.86 | .985 | 25.02 | .800 | 20.32 |
| 5 | .200 | 5.08 | .285 | 7.24 | N/A | N/A | 20 | .950 | 24.13 | 1.035 | 26.29 | .850 | 21.59 |
| 6 | .250 | 6.35 | .335 | 8.51 | N/A | N/A | 21 | 1.000 | 25.40 | 1.085 | 27.56 | .900 | 22.86 |
| 7 | .300 | 7.62 | .385 | 9.78 | .200 | 5.08 | 22 | 1.050 | 26.67 | 1.135 | 28.83 | .950 | 24.13 |
| 8 | .350 | 8.89 | .435 | 11.05 | .250 | 6.35 | 23 | 1.100 | 27.94 | 1.185 | 30.10 | 1.000 | 25.4 |
| 9 | .400 | 10.16 | .485 | 12.32 | .300 | 7.62 | 24 | 1.150 | 29.21 | 1.235 | 31.37 | 1.050 | 26.67 |
| 10 | .450 | 11.43 | .535 | 13.59 | .350 | 8.89 | 25 | 1.200 | 30.48 | 1.285 | 32.64 | 1.100 | 27.94 |
| 11 | .500 | 12.70 | .585 | 14.86 | .400 | 10.16 | 26 | 1.250 | 31.75 | 1.335 | 33.91 | 1.150 | 29.21 |
| 12 | .550 | 13.97 | .635 | 16.13 | .450 | 11.43 | 27 | 1.300 | 33.02 | 1.385 | 35.18 | 1.200 | 30.48 |
| 13 | .600 | 15.24 | .685 | 17.40 | .500 | 12.7 | 28 | 1.350 | 34.29 | 1.435 | 36.45 | 1.250 | 31.75 |
| 14 | .650 | 16.51 | .735 | 18.67 | .550 | 13.97 | 29 | 1.400 | 35.56 | 1.485 | 37.72 | 1.300 | 33.02 |
| 15 | .700 | 17.78 | .785 | 19.94 | .600 | 15.24 | 30 | 1.450 | 36.83 | 1.535 | 38.99 | 1.350 | 34.29 |

Center Latch Locations

Even Number of Cavities

Odd Number of Cavities



Latch placed on next lower cavity prior to centerline.
 Latch position = (# of Cavities) ÷ 2.



Latch placed in cavity on centerline.
 Latch Position = (# of Cavities+1) ÷ 2.



Series 171 MicroStrips™ Single Row Strips with Solid Wire 171-002



MicroStrips™ with Solid Wire

These .050" pitch single row microstrips are factory-crimped to gold-plated solid copper wire. Available with 1 to 30 contacts. Can be used for PCB header. Solder-dipped versions have 60/40 tin-lead solder. Optional latching mechanism provides secure connection. Guide pins provide circuit polarization. Contacts are twistpin type and are gold-plated. Housing is molded LCP thermoplastic. Suitable for high-reliability applications where long-term resistance to fretting corrosion is a necessity. 3 A., 600 Vac, -55C to +150C.

| How To Order Microstrips™ with Solid Wire | |
|---|--|
| Sample Part Number | 171-002 -7 S -5 C 4 -1.000 -P1 CL MH |
| Series | 171-002 - Single Row MicroStrip, .050" Contact Spacing, Solid Wire |
| Number of Cavities | 1 to 30 Total number of cavities includes guide pins, latches and mounting holes. The number of cavities equals the number of electrical circuits plus 1 cavity for each guide pin and latch, plus 6 cavities for the mounting hole option. |
| Contact Type | <div style="display: flex; justify-content: space-around;"> <div style="text-align: center;"> <p>P Pin Contacts</p>  </div> <div style="text-align: center;"> <p>S Socket Contacts</p>  </div> </div> |
| Wire Gage | 4 - #24 AWG 5 - #25 AWG 6 - #26 AWG |
| Wire Type | C - Solid Copper |
| Wire Finish | 3 - Solder Dipped in 60/40 Tin-Lead 4 - Gold-plated |
| Wire Length (Inches) | .125, .250, .500, 1.000, 1.500, 2.000 Wire Length In Inches ±.200/.000 |
| Optional Guide Pin | <div style="display: flex; justify-content: space-between;"> <div style="width: 22%;"> <p>Omit For No Guide Pin</p>  </div> <div style="width: 22%;"> <p>P1 Guide Pin in Cav. #1</p>  </div> <div style="width: 22%;"> <p>PB Guide Pin at Both Ends</p>  </div> <div style="width: 22%;"> <p>P(x) Replace (X) with guide pin location.</p>  <p style="text-align: center;">P3 shown above:</p> </div> </div> |
| Optional Latch | <div style="display: flex; justify-content: space-between;"> <div style="width: 33%;"> <p>Omit For No Latch</p>  </div> <div style="width: 33%;"> <p>CL Center Latch</p>  </div> <div style="width: 33%;"> <p>BL Latch at Both Ends</p>  </div> </div> |
| Optional Mounting Holes | <div style="display: flex; justify-content: space-between;"> <div style="width: 33%;"> <p>Omit For No Mounting Holes</p>  </div> <div style="width: 33%;"> <p>MH Mounting Holes</p>  </div> <div style="width: 33%;"> <p>The three cavities on each end are filled with epoxy. Two .062" (1.57mm) holes are cross-drilled to allow for attachment to a mounting surface.</p> </div> </div> |

NOTE: when ordering "BLMH" Strip Connector allow for only 3 cavities on each end (6 total)

Series 171 MicroStrips™ Single Row Strips with Insulated Wire 171-003



Single Row MicroStrips™ with Insulated Stranded Wire

These .050" pitch single row microstrips are factory-terminated to military-grade hookup wire. Crimp termination. Available with 1 to 30 contacts. Optional latching mechanism prevents de-mating. Guide pins provide circuit polarization. Contacts are twistpin type and are gold-plated. Housing is molded LCP thermoplastic. Available with standard M22759/11 ETFE wire, or upgrade to M22759/33 space grade wire. Suitable for high-reliability applications where long-term resistance to fretting corrosion is a necessity. 3 A., 600 Vac, -55C to +150C. Wire is 600V, 200C.

| How To Order Single Row Microstrips™ with Insulated Wire | |
|--|---|
| Sample Part Number | 171-003 -7 S -6 K 1 -18 -P1 CL MH |
| Series | 171-003 - Single Row MicroStrip |
| Number of Cavities | 1 to 30 Total number of cavities includes guide pins, latches and mounting holes <i>The number of cavities equals the number of electrical circuits plus 1 cavity for each guide pin and latch, plus 6 cavities for the mounting hole option.</i> |
| Contact Type | P Pin Contacts  S Socket Contacts  |
| Wire Gage | 6 - #26 AWG 8 - #28 AWG 0 - #30 AWG Note: For 24 gage wire consult factory |
| Wire Type | K - Standard Wire Extruded PTFE per M22759/11, Silver-Plated Conductors (#30 AWG not available) E - NEMA HP3-EB 600 VRMS Type E M16878/4 (TFE) |
| Wire Color Code | J - Space Grade Wire; High Strength Lightweight Crosslinked Modified ETFE per M22759/33, Silver-Plated Conductors 1 - White 5 - Color-Coded per MIL-STD-681 Wires 1-10 are solid color, 11-up are striped. 7 - 10 Color Repeat Wires are solid color per MIL-STD-681 color code system. |
| Wire Length (Inches) | Example: 18 = 18 inches +1.00/-0.00 (+25.4/-0.0) |
| Optional Guide Pin | Omit For No Guide Pin P1 Guide Pin in Cav. #1  PB Guide Pin at Both Ends  P(x) Replace (X) with guide pin location.  P3 shown above: |
| Optional Latch | Omit For No Latch CL Center Latch  BL Latch at Both Ends  |
| Optional Mounting Holes | Omit For No Mounting Holes MH Mounting Holes  |

NOTE: when ordering "BLMH" Strip Connector allow for only 3 cavities on each end (6 total)



Series 171 MicroStrips™ Single Row Strips with Insulated Wire 171-003



Table I: Dimensions

| # of Cavities | (A) | | B Max. | | C | | # of Cavities | (A) | | B Max. | | C | |
|---------------|------|-------|--------|-------|------|-------|---------------|-------|-------|--------|-------|-------|-------|
| | In. | mm. | In. | mm. | In. | mm. | | In. | mm. | In. | mm. | In. | mm. |
| 1 | - | - | .085 | 2.16 | N/A | N/A | 16 | .750 | 19.05 | .835 | 21.21 | .650 | 16.51 |
| 2 | .050 | 1.27 | .135 | 3.43 | N/A | N/A | 17 | .800 | 20.32 | .885 | 22.48 | .700 | 17.78 |
| 3 | .100 | 2.54 | .185 | 4.70 | N/A | N/A | 18 | .850 | 21.59 | .935 | 23.75 | .750 | 19.05 |
| 4 | .150 | 3.81 | .235 | 5.97 | N/A | N/A | 19 | .900 | 22.86 | .985 | 25.02 | .800 | 20.32 |
| 5 | .200 | 5.08 | .285 | 7.24 | N/A | N/A | 20 | .950 | 24.13 | 1.035 | 26.29 | .850 | 21.59 |
| 6 | .250 | 6.35 | .335 | 8.51 | N/A | N/A | 21 | 1.000 | 25.40 | 1.085 | 27.56 | .900 | 22.86 |
| 7 | .300 | 7.62 | .385 | 9.78 | .200 | 5.08 | 22 | 1.050 | 26.67 | 1.135 | 28.83 | .950 | 24.13 |
| 8 | .350 | 8.89 | .435 | 11.05 | .250 | 6.35 | 23 | 1.100 | 27.94 | 1.185 | 30.10 | 1.000 | 25.4 |
| 9 | .400 | 10.16 | .485 | 12.32 | .300 | 7.62 | 24 | 1.150 | 29.21 | 1.235 | 31.37 | 1.050 | 26.67 |
| 10 | .450 | 11.43 | .535 | 13.59 | .350 | 8.89 | 25 | 1.200 | 30.48 | 1.285 | 32.64 | 1.100 | 27.94 |
| 11 | .500 | 12.70 | .585 | 14.86 | .400 | 10.16 | 26 | 1.250 | 31.75 | 1.335 | 33.91 | 1.150 | 29.21 |
| 12 | .550 | 13.97 | .635 | 16.13 | .450 | 11.43 | 27 | 1.300 | 33.02 | 1.385 | 35.18 | 1.200 | 30.48 |
| 13 | .600 | 15.24 | .685 | 17.40 | .500 | 12.7 | 28 | 1.350 | 34.29 | 1.435 | 36.45 | 1.250 | 31.75 |
| 14 | .650 | 16.51 | .735 | 18.67 | .550 | 13.97 | 29 | 1.400 | 35.56 | 1.485 | 37.72 | 1.300 | 33.02 |
| 15 | .700 | 17.78 | .785 | 19.94 | .600 | 15.24 | 30 | 1.450 | 36.83 | 1.535 | 38.99 | 1.350 | 34.29 |

Center Latch Locations



Series 171 MicroStrips™

Single Row Thru-Hole Board Mount Strips

171-004, 171-005, 171-006, and 171-007



Single Row Board Mount MicroStrips™

These .050" pitch single row PCB thru-hole microstrips are available in four types- vertical mount, right angle single row and two right angle staggered versions. Available with 1 to 30 contacts. PC tails are .020" diameter. Optional latching mechanism prevents de-mating. Guide pins provide circuit polarization. Contacts are twistpin type and are gold-plated. Housing is molded LCP thermoplastic. Suitable for high-reliability applications where long-term resistance to fretting corrosion is a necessity. 3 A., 600 Vac, -55C to +150C.

How To Order Single Row Thru-Hole PCB MicroStrips™

| Sample Part Number | 171-006 | -7 | P | -.125 | -P1 | CL | MH |
|-------------------------|---|---|---|--|-----|----|----|
| Series | <p>171-004 Right Angle, Single Row PC Tails</p>  <p>171-005 Right Angle, Two Row PC Tails with .050" Between Rows</p>  <p>171-006 Right Angle, Two Row PC Tails with .100" Between Rows</p>  <p>171-007 Vertical Mount</p>  | | | | | | |
| Number of Cavities | <p>1 to 30 Total number of cavities includes guide pins, latches and mounting holes. The number of cavities equals the number of electrical circuits plus 1 cavity for each guide pin and latch, plus 6 cavities for the mounting hole option.</p> | | | | | | |
| Contact Type | <p>P Pin Contacts</p>  | <p>S Socket Contacts</p>  | | | | | |
| PC Tail Length (In.) | <p>.080, .110, .125, .150, .172, .190, .250 Tail Length In Inches ±.015</p> | | | | | | |
| Optional Guide Pin | <p>Omit For No Guide Pin</p> | <p>P1 Guide Pin in Cavity #1</p>  | <p>PB Guide Pin at Both Ends</p>  | <p>P(x) Replace (X) with guide pin location.</p>  <p>P3 shown above:</p> | | | |
| Optional Latch | <p>Omit For No Latch</p> | <p>CL Center Latch</p>  | <p>BL Latch at Both Ends</p>  | | | | |
| Optional Mounting Holes | <p>Omit For No Mounting Holes</p> | <p>MH Mounting Holes</p>  | <p>The three cavities on each end are filled with epoxy. Two .062" (1.57mm) holes are cross-drilled to allow for attachment to a mounting surface</p> | | | | |

NOTE: when ordering "BLMH" Strip Connector allow for only 3 cavities on each end (6 total)



MWS MicroStrips™

Single Row Thru-Hole Board Mount Strips

171-004, 171-005, 171-006, and 171-007

Dimensions

PIN CONNECTOR



SOCKET CONNECTOR



| # of Cavities | (A) | | B Max. | | C | | # of Cavities | (A) | | B Max. | | C | |
|---------------|------|-------|--------|-------|------|-------|---------------|-------|-------|--------|-------|-------|-------|
| | In. | mm. | In. | mm. | In. | mm. | | In. | mm. | In. | mm. | In. | mm. |
| 1 | - | - | .085 | 2.16 | N/A | N/A | 16 | .750 | 19.05 | .835 | 21.21 | .650 | 16.51 |
| 2 | .050 | 1.27 | .135 | 3.43 | N/A | N/A | 17 | .800 | 20.32 | .885 | 22.48 | .700 | 17.78 |
| 3 | .100 | 2.54 | .185 | 4.70 | N/A | N/A | 18 | .850 | 21.59 | .935 | 23.75 | .750 | 19.05 |
| 4 | .150 | 3.81 | .235 | 5.97 | N/A | N/A | 19 | .900 | 22.86 | .985 | 25.02 | .800 | 20.32 |
| 5 | .200 | 5.08 | .285 | 7.24 | N/A | N/A | 20 | .950 | 24.13 | 1.035 | 26.29 | .850 | 21.59 |
| 6 | .250 | 6.35 | .335 | 8.51 | N/A | N/A | 21 | 1.000 | 25.40 | 1.085 | 27.56 | .900 | 22.86 |
| 7 | .300 | 7.62 | .385 | 9.78 | .200 | 5.08 | 22 | 1.050 | 26.67 | 1.135 | 28.83 | .950 | 24.13 |
| 8 | .350 | 8.89 | .435 | 11.05 | .250 | 6.35 | 23 | 1.100 | 27.94 | 1.185 | 30.10 | 1.000 | 25.4 |
| 9 | .400 | 10.16 | .485 | 12.32 | .300 | 7.62 | 24 | 1.150 | 29.21 | 1.235 | 31.37 | 1.050 | 26.67 |
| 10 | .450 | 11.43 | .535 | 13.59 | .350 | 8.89 | 25 | 1.200 | 30.48 | 1.285 | 32.64 | 1.100 | 27.94 |
| 11 | .500 | 12.70 | .585 | 14.86 | .400 | 10.16 | 26 | 1.250 | 31.75 | 1.335 | 33.91 | 1.150 | 29.21 |
| 12 | .550 | 13.97 | .635 | 16.13 | .450 | 11.43 | 27 | 1.300 | 33.02 | 1.385 | 35.18 | 1.200 | 30.48 |
| 13 | .600 | 15.24 | .685 | 17.40 | .500 | 12.7 | 28 | 1.350 | 34.29 | 1.435 | 36.45 | 1.250 | 31.75 |
| 14 | .650 | 16.51 | .735 | 18.67 | .550 | 13.97 | 29 | 1.400 | 35.56 | 1.485 | 37.72 | 1.300 | 33.02 |
| 15 | .700 | 17.78 | .785 | 19.94 | .600 | 15.24 | 30 | 1.450 | 36.83 | 1.535 | 38.99 | 1.350 | 34.29 |

Center Latch Locations

Even Number of Cavities



Latch placed on next lower cavity prior to centerline.
Latch position = (# of Cavities) ÷ 2.

Odd Number of Cavities



Latch placed in cavity on centerline.
Latch Position = (# of Cavities+1) ÷ 2.

Series 171 MicroStrips™
Single Row Board Mount Strips
 PCB layouts: 171-004 and 171-005



| Printed Circuit Board Layouts | | |
|--|---|---|
| TYPE | PIN CONNECTOR | SOCKET CONNECTOR |
| <p>171-004</p>  <p>Right Angle Single Row .050" (1.27) Centers</p> |  |  |
| <p>171-005</p>  <p>Right Angle Staggered .050" (1.27) Offset</p> |  |  |





Series 171 MicroStrips™
Single Row Board Mount Strips
PCB Layouts: 171-006 and 171-007

Printed Circuit Board Layouts

| TYPE | PIN CONNECTOR | SOCKET CONNECTOR |
|--|---|--|
| <p>171-006</p>  <p>Right Angle Staggered .100" (2.54) Offset</p> |  <p>PC TAIL LENGTH</p> <p>$\phi .020$ (0.51)</p> <p>.100 (2.54)</p> <p>.100 (2.54)</p> <p>.400 (10.16)</p> <p>.100 (2.54) TYP</p> <p>.050 (1.27) TYP</p> <p>CONTACT 1</p> |  <p>$\phi .020$ (0.51)</p> <p>.100 (2.54)</p> <p>.100 (2.54)</p> <p>.100 (2.54)</p> <p>PC TAIL LENGTH</p> <p>.225 (5.72)</p> <p>.100 (2.54) TYP</p> <p>.050 (1.27) TYP</p> <p>CONTACT 1</p> |
| <p>171-007</p>  <p>Vertical Mount .100" (2.54) Spacing</p> |  <p>PC TAIL LENGTH</p> <p>.100 (2.54)</p> <p>.120 (3.05)</p> <p>$\phi .020$ (0.51)</p> <p>CONTACT 1</p> <p>.100 (2.54)</p> <p>.100 (2.54)</p> <p>.050 (1.27)</p> |  <p>PC TAIL LENGTH</p> <p>.100 (2.54)</p> <p>$\phi .020$ (0.51)</p> <p>.120 (3.05)</p> <p>CONTACT 1</p> <p>.100 (2.54)</p> <p>.100 (2.54)</p> <p>.050 (1.27)</p> |



Series 171 MicroStrips™ Single Row Surface Mount Strips 171-008



Micro-D Latching
MicroStrips



Single Row Surface Mount MicroStrips™

These .050" pitch single row surface mount microstrips are available with 1 to 30 contacts. SMT tails are .013" diameter and are solder dipped in 60/40 tin-lead. Optional latching mechanism provides secure connection. Optional guide pins provide circuit polarization. Contacts are twistpin type and are gold-plated. Housing is molded LCP thermoplastic. Suitable for high-reliability applications where long-term resistance to fretting corrosion is a necessity. 3 A., 600 Vac, -55C to +150C.

| How To Order Single Row Thru-Hole PCB MicroStrips™ | | | | | | | |
|--|---|---|--|---|-----|----|----|
| Sample Part Number | 171-008 | | -5 | P | -P1 | CL | MH |
| Series | 171-008 - Single Row MicroStrip, .050" Contact Spacing, Surface Mount Tails | | | | | | |
| Number of Cavities | 1 to 30 Total number of cavities includes guide pins, latches and mounting holes. The number of cavities equals the number of electrical circuits plus 1 cavity for each guide pin and latch, plus 6 cavities for the mounting hole option. | | | | | | |
| Contact Type | P Pin Contacts  | S Socket Contacts  | | | | | |
| Optional Guide Pin | Omit For No Guide Pin  | P1 Guide Pin in Cavity #1  | PB Guide Pin at Both Ends  | P(x) Replace (X) with guide pin location.  P3 shown above: | | | |
| Optional Latch | Omit For No Latch  | CL Center Latch  | BL Latch at Both Ends  | | | | |
| Optional Mounting Holes | Omit For No Mounting Holes  | MH Mounting Holes  | | The three cavities on each end are filled with epoxy. Two .062" (1.57mm) holes are cross-drilled to allow for attachment to a mounting surface | | | |

NOTE: when ordering "BLMH" Strip Connector allow for only 3 cavities on each end (6 total)





Series 171 MicroStrips™ Single Row Surface Mount Strips 171-008

Dimensions

PIN CONNECTOR



SOCKET CONNECTOR



TYPICAL SURFACE MOUNT CONFIGURATION



| # of Cavities | (A) | | B Max. | | C | | # of Cavities | (A) | | B Max. | | C | |
|---------------|------|-------|--------|-------|------|-------|---------------|-------|-------|--------|-------|-------|-------|
| | In. | mm. | In. | mm. | In. | mm. | | In. | mm. | In. | mm. | In. | mm. |
| 1 | - | - | .085 | 2.16 | N/A | N/A | 16 | .750 | 19.05 | .835 | 21.21 | .650 | 16.51 |
| 2 | .050 | 1.27 | .135 | 3.43 | N/A | N/A | 17 | .800 | 20.32 | .885 | 22.48 | .700 | 17.78 |
| 3 | .100 | 2.54 | .185 | 4.70 | N/A | N/A | 18 | .850 | 21.59 | .935 | 23.75 | .750 | 19.05 |
| 4 | .150 | 3.81 | .235 | 5.97 | N/A | N/A | 19 | .900 | 22.86 | .985 | 25.02 | .800 | 20.32 |
| 5 | .200 | 5.08 | .285 | 7.24 | N/A | N/A | 20 | .950 | 24.13 | 1.035 | 26.29 | .850 | 21.59 |
| 6 | .250 | 6.35 | .335 | 8.51 | N/A | N/A | 21 | 1.000 | 25.40 | 1.085 | 27.56 | .900 | 22.86 |
| 7 | .300 | 7.62 | .385 | 9.78 | .200 | 5.08 | 22 | 1.050 | 26.67 | 1.135 | 28.83 | .950 | 24.13 |
| 8 | .350 | 8.89 | .435 | 11.05 | .250 | 6.35 | 23 | 1.100 | 27.94 | 1.185 | 30.10 | 1.000 | 25.4 |
| 9 | .400 | 10.16 | .485 | 12.32 | .300 | 7.62 | 24 | 1.150 | 29.21 | 1.235 | 31.37 | 1.050 | 26.67 |
| 10 | .450 | 11.43 | .535 | 13.59 | .350 | 8.89 | 25 | 1.200 | 30.48 | 1.285 | 32.64 | 1.100 | 27.94 |
| 11 | .500 | 12.70 | .585 | 14.86 | .400 | 10.16 | 26 | 1.250 | 31.75 | 1.335 | 33.91 | 1.150 | 29.21 |
| 12 | .550 | 13.97 | .635 | 16.13 | .450 | 11.43 | 27 | 1.300 | 33.02 | 1.385 | 35.18 | 1.200 | 30.48 |
| 13 | .600 | 15.24 | .685 | 17.40 | .500 | 12.7 | 28 | 1.350 | 34.29 | 1.435 | 36.45 | 1.250 | 31.75 |
| 14 | .650 | 16.51 | .735 | 18.67 | .550 | 13.97 | 29 | 1.400 | 35.56 | 1.485 | 37.72 | 1.300 | 33.02 |
| 15 | .700 | 17.78 | .785 | 19.94 | .600 | 15.24 | 30 | 1.450 | 36.83 | 1.535 | 38.99 | 1.350 | 34.29 |

Center Latch Locations

Even Number of Cavities



Latch placed on next lower cavity prior to centerline.
Latch position = (# of Cavities) ÷ 2.

Odd Number of Cavities



Latch placed in cavity on centerline.
Latch Position = (# of Cavities+1) ÷ 2.

Series 171 MicroStrips™ Single Row Back-to-Back MicroStrips™ 171-009



Micro-D Latching
MicroStrips



Single Row Back-to-Back MicroStrips™

These .050" pitch single row surface mount microstrips are available with 1 to 30 contacts. Optional latching mechanism provides secure connection. Optional guide pins provide circuit polarization. Contacts are TwistPin type and are gold-plated. Housing is molded LCP thermoplastic. Suitable for high-reliability applications where long-term resistance to fretting corrosion is a necessity. 3 A., 600 Vac, -55C to +150C.

How To Order Single Row Microstrips™ With Insulated Wire

| Sample Part Number | 171-009 | -13 | CS | -6 | K | 7 | -18 | -P1 | CL | MH |
|-------------------------|---|---|--|--|---|--|-------------|-----|----|----|
| Series | 171-009 - Single Row MicroStrip, .050" Contact Spacing, Surface Mount Tails | | | | | | | | | |
| Number of Cavities | 1 to 30 (See Table I) Total number of cavities includes guide pins, latches and mounting holes. The number of cavities equals the number of electrical circuits plus 1 cavity for each guide pin and latch, plus 6 cavities for the mounting hole option. | | | | | | | | | |
| Contact Type | GP - Pin Contacts GS - Socket Connector Both Ends CS - Pin Connector to Socket Connector | | | | | | | | | |
| Wire Gage | 6 - #26 AWG | | | 8 - #28 AWG | | | 0 - #30 AWG | | | |
| Wire Type | K - Standard Wire Extruded PTFE per M22759/11, Silver-Plated Conductors (#30 AWG not available) | | | | | J - Space Grade Wire; High Strength Lightweight Crosslinked Modified ETFE per M22759/33, Silver-Plated Conductors | | | | |
| Wire Color | 1 - White 5 - Color-Coded per MIL-STD-681 Wires 1-10 are solid color, 11-up are striped. | | | | | 7 - 10 Color Repeat Wires are solid color per MIL-STD-681 color code system. | | | | |
| Wire Length (Inches) | Example: 18 = 18 inches +1.00/-0.00 (+25.4/-0.0) | | | | | | | | | |
| Optional Guide Pin | Omit For No Guide Pin | P1 Guide Pin in Cavity #1  | PB Guide Pin at Both Ends  | P(x) Replace (X) with guide pin location.  P3 shown above: | | | | | | |
| Optional Latch | Omit For No Latch | CL Center Latch  | BL Latch at Both Ends  | | | | | | | |
| Optional Mounting Holes | Omit For No Mounting Holes | MH Mounting Holes  | | | | | | | | |

NOTE: when ordering "BLMH" Strip Connector allow for only 3 cavities on each end (6 total)





Series 171 MicroStrips™ Single Row Surface Mount Strips 171-009

Table I: Dimensions



| # Of Cavities | A | | B Max | | C ±.005 | |
|---------------|-------|-------|-------|-------|---------|-------|
| | in. | mm. | in. | mm. | in. | mm. |
| 1 | - | - | 0.085 | 2.16 | N/A | N/A |
| 2 | 0.050 | 1.27 | 0.135 | 3.43 | N/A | N/A |
| 3 | 0.100 | 2.54 | 0.185 | 4.70 | N/A | N/A |
| 4 | 0.150 | 3.81 | 0.235 | 5.97 | N/A | N/A |
| 5 | 0.200 | 5.08 | 0.285 | 7.24 | N/A | N/A |
| 6 | 0.250 | 6.35 | 0.335 | 8.51 | N/A | N/A |
| 7 | 0.300 | 7.62 | 0.385 | 9.78 | 0.200 | 5.08 |
| 8 | 0.350 | 8.89 | 0.435 | 11.05 | 0.250 | 6.35 |
| 9 | 0.400 | 10.16 | 0.485 | 12.32 | 0.300 | 7.62 |
| 10 | 0.450 | 11.43 | 0.535 | 13.59 | 0.350 | 8.89 |
| 11 | 0.500 | 12.70 | 0.585 | 14.86 | 0.400 | 10.16 |
| 12 | 0.550 | 13.97 | 0.635 | 16.13 | 0.450 | 11.43 |
| 13 | 0.600 | 15.24 | 0.685 | 17.40 | 0.500 | 12.70 |
| 14 | 0.650 | 16.51 | 0.735 | 18.67 | 0.550 | 13.97 |
| 15 | 0.700 | 17.78 | 0.785 | 19.94 | 0.600 | 15.24 |
| 16 | 0.750 | 19.05 | 0.835 | 21.21 | 0.650 | 16.51 |
| 17 | 0.800 | 20.32 | 0.885 | 22.48 | 0.700 | 17.78 |
| 18 | 0.850 | 21.59 | 0.935 | 23.75 | 0.750 | 19.05 |
| 19 | 0.900 | 22.86 | 0.985 | 25.02 | 0.800 | 20.32 |
| 20 | 0.950 | 24.13 | 1.035 | 26.29 | 0.850 | 21.59 |
| 21 | 1.000 | 25.40 | 1.085 | 27.56 | 0.900 | 22.86 |
| 22 | 1.050 | 26.67 | 1.135 | 28.83 | 0.950 | 24.13 |
| 23 | 1.100 | 27.94 | 1.185 | 30.10 | 1.000 | 25.40 |
| 24 | 1.150 | 29.21 | 1.235 | 31.37 | 1.050 | 26.67 |
| 25 | 1.200 | 30.48 | 1.285 | 32.64 | 1.100 | 27.94 |
| 26 | 1.250 | 31.75 | 1.335 | 33.91 | 1.150 | 29.21 |
| 27 | 1.300 | 33.02 | 1.385 | 35.18 | 1.200 | 30.48 |
| 28 | 1.350 | 34.29 | 1.435 | 36.45 | 1.250 | 31.75 |
| 29 | 1.400 | 35.56 | 1.485 | 37.72 | 1.300 | 33.02 |
| 30 | 1.450 | 36.83 | 1.535 | 38.99 | 1.350 | 34.29 |

Index



Micro-D
Hermetic

| Part No. | Description | Page |
|------------------|--|------|
| 83513/01 & 02 | /01 & /02 Solder Cup Terminated, Metal Shell Connector | L-4 |
| 83513/03 & 04 | /03 & /04 Pre-Wired Crimp Terminated, Metal Shell Connector | L-5 |
| 83513/06 & 07 | /06 & /07 Solder Cup Terminated, Plastic Shell Connector | L-7 |
| 83513/08 & 09 | /08 & /09 Pre-Wired Crimp Terminated, Plastic Shell Connector | L-8 |
| 83513/10 & 15 | /10 Thru /15 Condensed Right Angle PCB Terminated Connector | L-10 |
| 83513/16 & 21 | /16 Thru /21 Right Angle PCB Terminated Connector | L-14 |
| 83513/22 thru 27 | /22 Thru /27 Straight PCB Terminated Connector | L-18 |
| 83513/28 thru 33 | /28 Thru /33 Condensed Straight PCB Terminated Connectors | L-22 |
| 83513/05 | /05 Jackscrew and Jackpost Hardware | L-26 |
| 171-001 | Solder Cup | Q-4 |
| 171-002 | Solid Wire | Q-6 |
| 171-003 | Insulated Wire | Q-7 |
| 171-004 | PCB Right Angle PC Tails on .050 Spacing | Q-9 |
| 171-005 | PCB Right Angle PC Tails with .050 Between Rows Staggered | Q-9 |
| 171-006 | PCB Right Angle PC Tails with .100 Between Rows Staggered | Q-9 |
| 171-007 | PCB Vertical Mount | Q-9 |
| 171-008 | Surface Mount Strips Connectors | Q-13 |
| 171-009 | Back-to-Back MicroStrips Connectors | Q-15 |
| 177-007 | Shorting Plug Assembly | N-3 |
| 177-140H | Solder Cup or PC Tail Terminated; Solder, Braze or Weld Mount Connectors | H-6 |
| 177-232 | Front Mount MIL-DTL-83513 Type, Shell Size 37 | H-8 |
| 177-704H | Insulated Wire Terminated Solder, Braze or Weld Mount Connectors | H-6 |
| 177-705H | Solder Cup or PC Tail Rear Panel Mount Connectors | H-8 |
| 177-706H | Insulated Wire Rear Panel Mount Connectors | H-11 |
| 177-859 | Front Mount MIL-DTL-83513 Type, Shell Size 9-21 | H-8 |
| 179-013-XX | Stainless Steel Jackscrew Kits with C Clips | N-11 |
| 240-030 | Solder Cup Connectors | G-7 |
| 240-031 | PCB Vertical Mount Connectors | G-9 |
| 240-032 | Pre-Wired with Insulated Wire Connectors | G-14 |
| 240-033 | Pin-Socket In-Line Filter Adapters | G-16 |
| 240-034 | PCB Right Angle Connectors | G-18 |
| 240-075 | Rear Panel Mount Solder Cup Connectors | G-22 |
| 240-076 | PCB Rear Panel Mount Vertical Connectors | G-24 |
| 240-077 | Rear Panel Mount Insulated Wire Connectors | G-27 |
| 240-078 | Rear Panel Mount Condensed Board Right Angle Connectors | G-29 |
| 247-379 | Filter Edge Board Receptacle | G-30 |
| 249-EMITS | EMITS EMI Troubleshooter | G-35 |
| 500-010 | EMI/RFI Round Cable Entry Backshells | M-6 |



| Part No. | Description | Page |
|-----------|--|------|
| 500-011 | EMI/RFI Shield Sock Round Cable Entry Backshell | M-10 |
| 500-012 | Qwik-Ty Strain Relief Backshell | M-25 |
| 500-017 | Metal Protective Covers with Silicone Rubber Gasket | N-5 |
| 500-037 | Metal Protective Covers with Silicone Rubber Gasket for Rear Panel Mounted Micro-D | N-5 |
| 500-047 | EMI/RFI Elliptical Banding Backshell | M-14 |
| 500-107 | Metal Protective Covers with Silicone Rubber Gaskets | N-7 |
| 507-035 | Potting Shell | M-26 |
| 507-088 | Composite EMI/RFI Round Cable Entry Backshell | M-12 |
| 507-142 | EMI/RFI Dual Entry Round Cable Banding Backshell | M-8 |
| 507-145 | EMI/RFI Split Shell Banding Backshell with Screwlocks | M-9 |
| 507-146 | Round Cable Entry Strain Relief Backshell with Saddle Bar Clamps | M-24 |
| 507-175 | Straight, Top, and 45° Entry EMI/RFI Elliptical Banding Backshell | M-15 |
| 507-178 | EMI/RFI Elliptical Split Shell Banding Backshell | M-21 |
| 507-198 | Saddle Bar Strain-Relief Backshell | M-23 |
| 507-296 | EMI/RFI Elliptical Metal Shell Backshell | M-19 |
| 507-297 | Side Entry EMI/RFI Lightweight Metal Shell Backshell | M-17 |
| 780-555 | "Marshal Bean" Protective Rubber Covers with Tether Rope | N-9 |
| 2470-1048 | Combo Micro-D Filter connector | G-34 |
| GHTM | Back-To-Back Cable Assemblies | J-10 |
| GHTM | Right Angle Printed Circuit Board Headers | J-13 |
| GHTM | Solder Cup Connectors | J-3 |
| GHTM | Insulated Wire Connectors | J-7 |
| GMDE | Environmentally Sealed Rear Panel Mount Connector | B-23 |
| GMDR | Insulated Wire with Right Angle Exit Connector | B-21 |
| GMLM | MasterLatch™ Latching Micro-D Connector | B-29 |
| GMPM | Solder Cup | F-3 |
| GMPM | Pre-Wired | F-6 |
| GMPM | Printed Circuit Board Connector | F-9 |
| GMR 7580 | Vertical Mount Connector | C-32 |
| GMR 7580C | Compact Flange Vertical Mount Connector | C-40 |
| GMR 7590 | Right Angle Mount Connector | C-36 |
| GMR 7590C | Compact Flange Right Angle Mount | C-44 |
| GMSM | Solder Cup, Solid Wire and Insulated Wire Connectors | D-2 |
| GMSM | Right Angle PCB Connectors | D-5 |
| GRPM | Solder Cup Terminated Rear Panel Mount Connector | B-2 |
| GRPM | Insulated-Wire Rear Panel Connector | B-4 |
| GRPM | Uninsulated Solid Wire Rear Panel Connector Connector | B-6 |
| GRPM-CBR | Condensed Board Right Angle, Rear Panel Mount Connector | C-4 |

Index



Micro-D
Hermetic

| Part No. | Description | Page |
|------------------|---|------|
| GRPM-CBS | Condensed Board Straight, Rear Panel Mount Connector | C-2 |
| GSWM | Spacewire Cable Assembly with Back-to-Back or Single Ended Wiring | B-27 |
| MLDM | Solder Cup Contacts | E-3 |
| MLDM | Metal Shell Insulated Wire Pigtails | E-5 |
| MLDM | Metal Shell Solid Wire Termination | E-7 |
| MLDM | Metal Shell Back-To-Back Cables | E-9 |
| MLDM | Metal Shell Right Angle Printed Circuit Board | E-11 |
| MWDL | Plastic Shell Solder Cup Termination | E-15 |
| MWDL | Plastic Shell Insulated Wire Pigtails | E-17 |
| MWDL | Plastic Shell Solid Wire Termination | E-19 |
| MWDL | Plastic Shell Back-To-Back Cables | E-21 |
| MWDL | Plastic Shell Right Angle PCB | E-23 |
| MWDM | Solder Cup Connector | B-8 |
| MWDM | Insulated Wire Connector | B-10 |
| MWDM | Back-To-Back Unshielded Cable Assemblies | B-12 |
| MWDM | Shielded Cable Assemblies, Untwisted and Twisted Pair | B-14 |
| MWDM | Uninsulated Wire Connector | B-19 |
| MWDM -BR | Board Right Angle, Thru-Hole Connector | C-10 |
| MWDM2L | Sav-Con® Connector Saver | N-2 |
| MWDM-BS | Board Straight, Vertical Mount Thru-Hole Connector | C-6 |
| MWDM-CBR | Condensed Board Right Angle Mount, Thru-Hole Connector | C-14 |
| MWDM-CBS | Condensed Board Straight .075 Inch Spacing Connector | C-20 |
| MWDM-SMR | Right Angle Surface Mount Connector | C-28 |
| MWEB-128P | Vertical Mount Backplane Connector | P-3 |
| MWEB-128S | Straddle Mount Card-Edge Connector | P-4 |
| MWEB-128S | Right Angle Board Connectors | P-5 |
| MWEB-184P | Vertical Mount Backplane Connector | P-6 |
| MWEB-184S | Straddle Mount Card-Edge Connector | P-7 |
| MWEB-184S | Right Angle Board Connector | P-8 |
| MWEB2L | Pre-Wired and Solder Cup Connectors | P-9 |
| MWKQ2L6 thru 2L9 | Quick Disconnect Micro Circular Connectors | P-10 |
| | Anti-Static Thermoplastic Dust Caps and Fluorosilicone Interfacial Seals | N-4 |
| | Stainless Steel Jackpost Kits, Rear Panel or Rear Panel PCB for Mil Spec and Commercial Parts | N-12 |
| | Stainless Steel Jackscrew Kits with E-Rings for Mil Spec and Commercial Parts | N-10 |

INDEX

Why Choose **GLENAIR?**



Plenty of Raw Materials!



Outstanding
Customer Service!



Abundant Machining Capacity!



In-House Assembly!



Huge "Same-Day" Inventory!



One of North America's
and Machining



High-Production Injection Molding Equipment



State-of-the-Art Plating Capabilities



The Industry's Most Experienced EMI/RFI Braided Shielding Specialists



Largest CNC Milling Installations



Clean Rooms for Filter Array and Printed Circuit Board Assembly



Out of This World
**INTERCONNECT
SOLUTIONS**

Glenair, Inc.

1211 Air Way • Glendale, California • 91201-2497
Telephone: 818-247-6000 • Fax: 818-500-9912 • sales@glenair.com
www.glenair.com

**Glenair Power
Products Group**

860 N. Main Street Extension
Wallingford, CT
06492

Telephone:
203-741-1115
Facsimile:
203-741-0053
sales@glenair.com

Glenair UK Ltd

40 Lower Oakham Way
Oakham Business Park
P.O. Box 37, Mansfield
Notts, NG18 5BY England

Telephone:
+44-1623-638100
Facsimile:
+44-1623-638111
sales@glenair.co.uk

Glenair Microway Systems

7000 North Lawndale Avenue
Lincolnwood, IL
60712

Telephone:
847-679-8833
Facsimile:
847-679-8849

Glenair Nordic AB

Gustav III : S Boulevard 46
S - 169 27 Solna
Sweden

Telephone:
+46-8-50550000
Facsimile:
+46-8-50550001
sales@glenair.se

Glenair Electric GmbH

Schaberweg 28
61348 Bad Homburg
Germany

Telephone:
06172 / 68 16 0
Facsimile:
06172 / 68 16 90
germany@glenair.com

Glenair Iberica

C/ La Vega, 16
45612 Velada
Spain

Telephone:
+34-925-89-29-88
Facsimile:
+34-925-89-29-87
sales@glenair.es

Glenair Italia S.p.A.

Via Del Lavoro, 7
40057 Quarto Inferiore –
Granarolo dell'Emilia
Bologna, Italy

Telephone:
+39-051-782811
Facsimile:
+39-051-782259
info@glenair.it

Glenair France SARL

7, Avenue Parmentier
Immeuble Central Parc #2
31200 Toulouse
France

Telephone:
+33-5-34-40-97-40
Facsimile:
+33-5-61-47-86-10
sales@glenair.fr





HIGH-PERFORMANCE
FOR MANAGING
YOUR BUSINESS
FROM ANYWHERE
ON ANY DEVICE
AND AT ANY TIME
AND FROM ANYWHERE

