

Series 801 Mighty Mouse Double-Start ACME Thread Receptacle 801-009 and 801-010 Ordering Information



Series 801



Rear Panel Jam Nut Mount
Shell Style 07



Square Flange Mount
Shell Style 02/12/22



In-Line
Shell Style 01

How To Order						
Sample Part Number	801-010	-02	Z1	16-55	S	A
Series (See Table I)	801-009 = Receptacle with Banding Platform 801-010 = Receptacle with Accessory Thread					
Shell Style (See Table III)	-01 = In-Line Receptacle for Free-Hanging Cables -02 = Thru Hole Square Flange Receptacle for Front or Rear Panel Mounting -12 = Square Flange Receptacle for Rear Panel Mounting with "Non-Locking" Clinch Nuts -22 = Square Flange Receptacle for Rear Panel Mounting with "Locking" Clinch Nuts -07 = Jam Nut Receptacle for Rear Panel Mounting					
Material and Finish	M = Aluminum / Electroless Nickel RoHS Compliant MT = Aluminum / Nickel-PTFE RoHS Compliant NF = Aluminum / Cadmium with Olive Drab Chromate ZNU = Aluminum / Zinc-Nickel with Black Chromate Z1 = Stainless Steel / Passivated RoHS Compliant					
Shell Size - Insert Arr	See Insert Arrangements page D-2					
Contact Type	A = Pin Connector, Less Contacts B = Socket Connector, Less Contacts P = Pin, Crimp S = Socket, Crimp G = #23 Pin with 30 AWG Crimp Barrel H = #23 Socket with 30 AWG Crimp Barrel					
Shell Key Positions (See Table II)	A = Normal B = Pos. B C = Pos. C D = Pos. D E = Pos. F F = Pos. F					

Table I: Series
 800-009 Banding Platform
 801-010 Rear Accessory Thread

Table II: Alternate Keyway Positions		
	A°	B°
A	150°	210°
B	75°	210°
C	95°	230°
D	140°	275°
E	75°	275°

Table III: Shell Style		
 Style -01 In-line	 Style -02/-12/-22 Square Flange	 Style -07 Jam Nut

Dimensions in Inches (millimeters) are subject to change without notice.

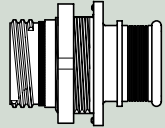
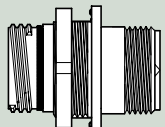
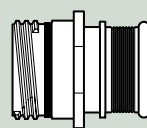
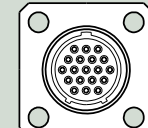
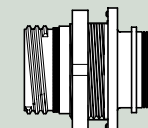

Series 801 Mighty Mouse Double-Start ACME Thread Contact Arrangements

Contact Arrangements						
Contact Arr.	No. of Contacts					
	#23	#20	#20HD	#16	#12*	#8**
5-3	3					
6-1				1		
6-23			3			
6-4	4					
6-6	6					
6-7	7					
7-1					1	
7-25			5			
7-10	10					
8-2				2		
8-200	4	2				
8-28			8			
8-13	13					
9-4				4		
9-200	4			2		
9-201	8	2				
9-210			10			
9-19	19					
10-2					2	
10-5				5		
10-26	26					
10-200	12				1	
10-201	4				2	
10-202	8			2		
11-31	31					
13-2					2	
13-3					3	
13-7				7		
13-220			20			
13-37	37					
13-200	6				2	
13-201	10				2	
13-202	20			2		
13-203	12			4		
13-204	12				2	
13-205	4				4	
16-5					5	

Mating Face View of Pin Connector (socket connector numbers are reversed)

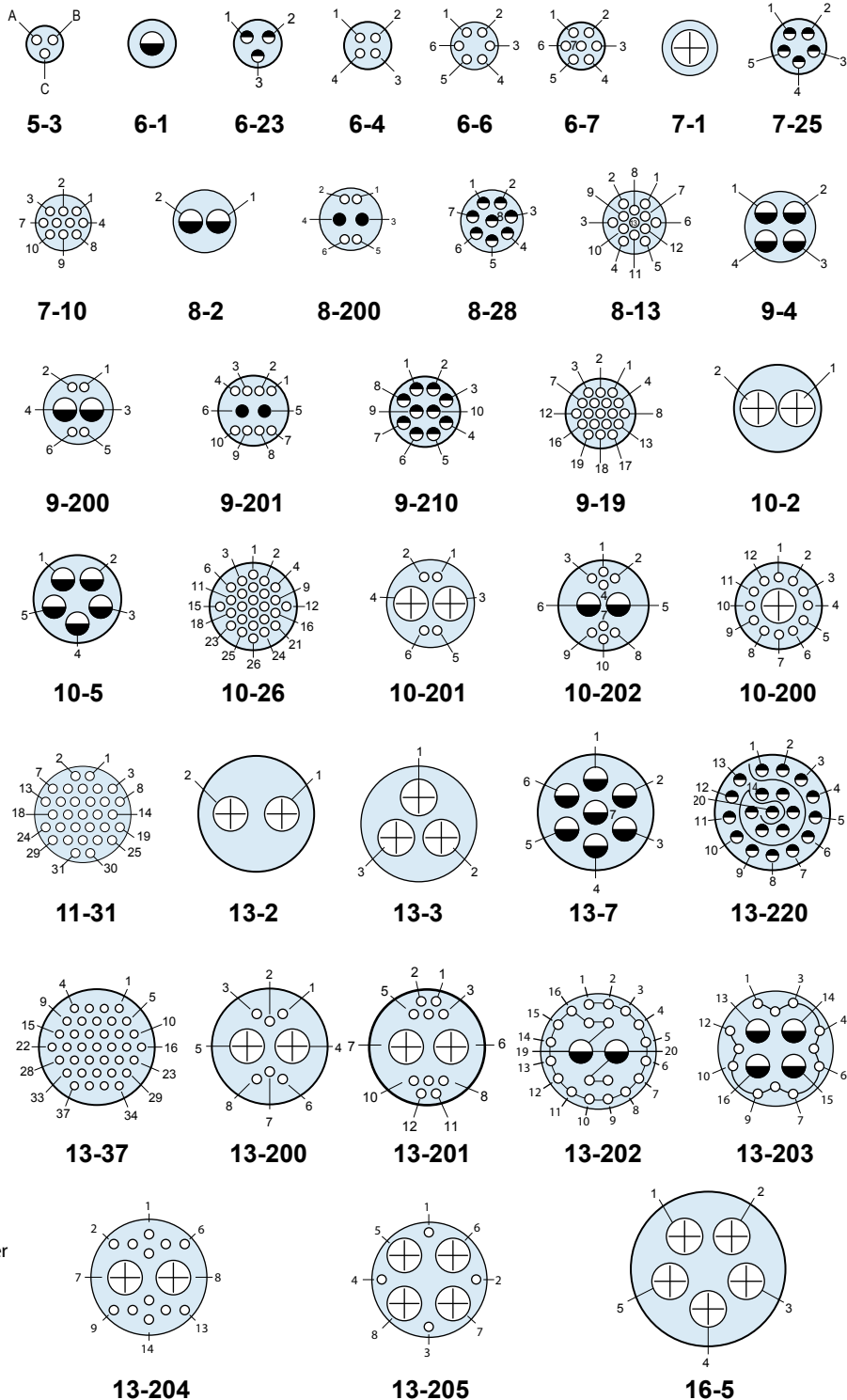

*All arrangements with #12 contacts and available with keyed Twinax contacts. Use mode code -688
 **Combo inserts using size #8 and #23 contacts order size #23, 857-034 socket or 809-335 pin contacts.

Contact Legend

#23◦ #20HD◐ #20● #16◑ #12⊕

Dimensions in Inches (millimeters) are subject to change without notice.

Series 801 Mighty Mouse Double-Start ACME Thread Contact Arrangements



Series 801

Contact Arrangements						
Contact Arr.	No. of Contacts					
	#23	#20	#20HD	#16	#12*	#8**
16-12				12		
16-235			35			
16-55	55					
16-204	40			2		
16-205	32			4		
16-206	34				2	
16-207	20				4	
16-208	32					1
17-7					7	
17-14				14		
17-241			41			
17-85	85					
17-203	40			4		
17-204	28				4	
17-205	40					1

Mating Face View of Pin Connector (socket connector numbers are reversed)

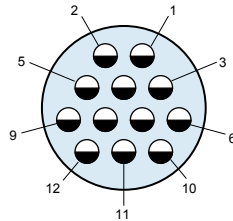

16-12

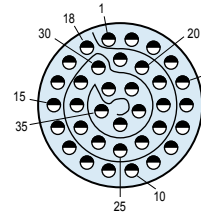

16-235

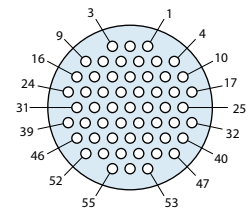

16-55

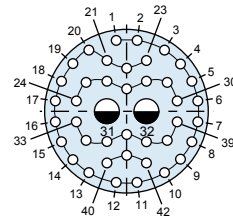

16-204

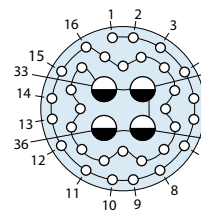

16-205

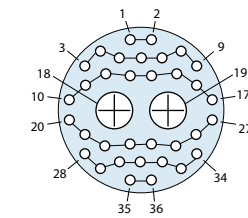

16-206

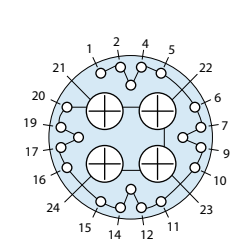

16-207

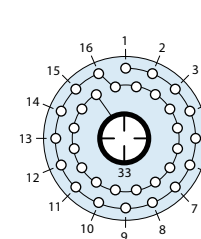

16-208

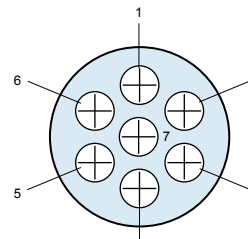

17-7

*All arrangements with #12 contacts and available with keyed Twinax contacts. Use mode code -688

**Combo inserts using size #8 and #23 contacts order size #23, 857-034 socket or 809-335 pin contacts.

Contact Legend

#23 ◯ #20HD ◯ #20 ● #16 ◯ #12 ⊕

Plug Key Positions		
	A°	B°
A	150°	210°
B	75°	210°
C	95°	230°
D	140°	275°
E	75°	275°
F	95°	210°

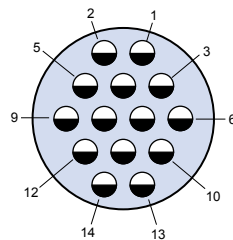

17-14

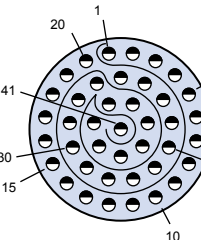

17-241

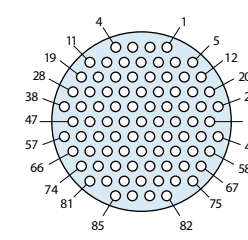

17-85

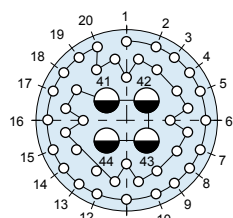

17-203

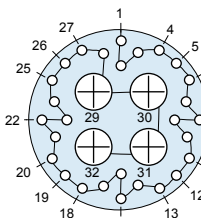

17-204

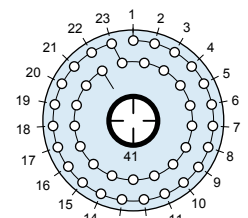

17-205

Dimensions in Inches (millimeters) are subject to change without notice.





Series 801 Mighty Mouse Double-Start ACME Thread General Information

Contact Arr.	Contact Arrangements					
	No. of Contacts					
	#23	#20	#20HD	#16	#12*	#8**
19-19				19		
19-201	44					2
19-202	23					4
19-255			55			
19-100	100					
21-12					12	
21-200	28					4
21-22				22		
21-269			69			
21-130	130					

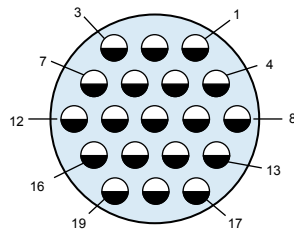

19-19

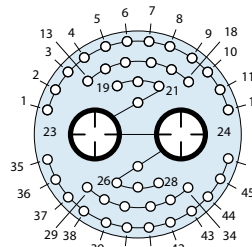

19-201

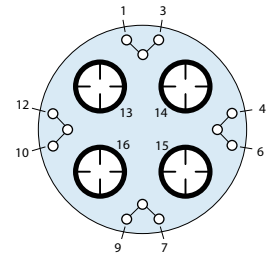

19-202

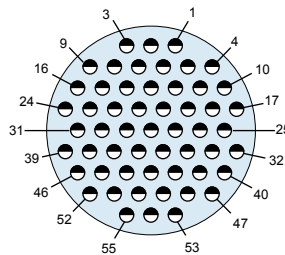

19-255

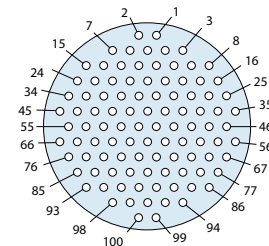

19-100

*All arrangements with #12 contacts and available with keyed Twinax contacts. Use mode code -688

**Combo inserts using size #8 and #23 contacts order size #23, 857-034 socket or 809-335 pin contacts.

Contact Legend

#23 ◯ #20HD ◯ #20 ● #16 ◐ #12 ⊕

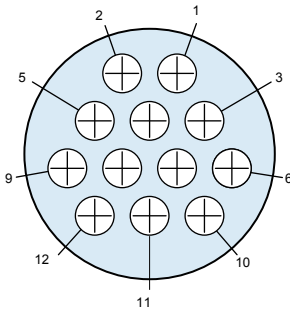

21-12

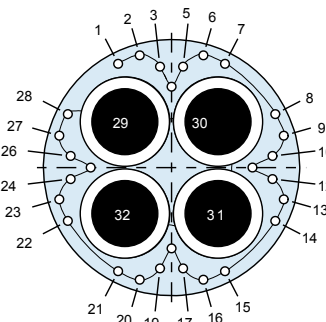

21-200

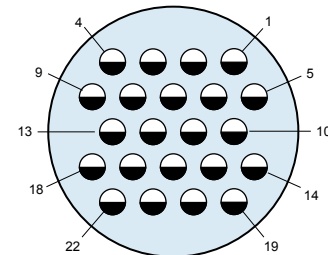

21-22

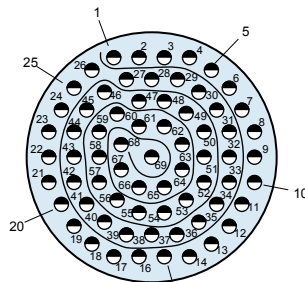

21-269

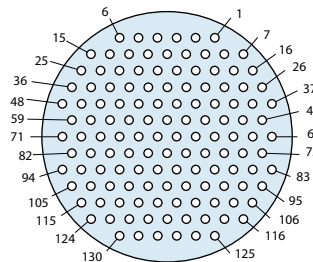

21-130

Dimensions in Inches (millimeters) are subject to change without notice.

Series 801 Mighty Mouse Double-Start ACME Thread General Information



Series 801

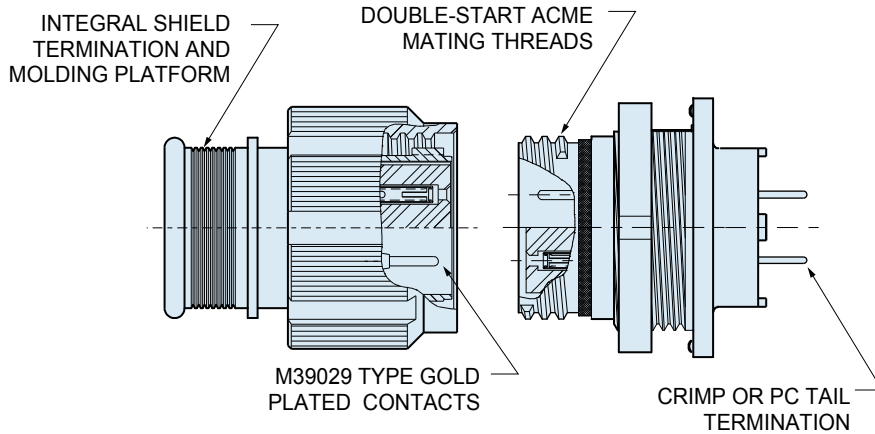

- Double-Start ACME Thread with anti-decoupling spring or ratchet
- Crimp Rear Release Contacts
- integral Band Platform
- Available with Size #12, #16, #20, #20HD and #23 Contacts
- Environmentally Sealed

Glenair's Series 801 Mighty Mouse Offers Mil-Spec Performance in a Lightweight, Ultraminiature Package



The 801 Series Mighty Mouse is ideal for use in high-density packaging applications where traditional military circular connectors are too large or too heavy. The double-start threads provide full mating in 1½ turns, and the plug features an anti-decoupling spring for vibration resistance. The unique integral molding/band platform allows direct shield attachment and cable overmolding. Receptacles are available with printed circuit board contacts. Plugs have anti-decoupling wave spring, or specify ratchet mechanism for added security.



Specifications	
Current Rating	#23-5 A, #20HD-7.5 A, #16-13 A, #12-23 A
Dielectric Withstanding Voltage	#23-750 VAC, #20HD-1000 VAC, #12 and #16-1800 VAC
Insulation Resistance	5000 megohms minimum
Operating Temperature	-65° C. to +175° C.
Shock	300 g.
Vibration	37 g.
Shielding Effectiveness	55 dB minimum from 100MHz to 1000MHz.
Durability	2000 mating cycles
See Series 80 General Information for complete performance specs.	

Materials and Finishes	
Shells, Jam Nuts	Aluminum alloy or stainless steel
Contacts	Copper alloy, 50 µInch gold plated
Insulators	Liquid crystal polymer (LCP)
Contact Retention Clip	Beryllium copper alloy
Interfacial Seal, O-rings, Wire Sealing Grommet	Fluorosilicone rubber
See Series 80 General Information for complete material and finish specs.	

Dimensions in Inches (millimeters) are subject to change without notice.