

Series 805 Mighty Mouse Triple-Start ACME Thread Receptacle 805-003 and 805-004 Ordering Information



Series 805



Three Shell Mounting Options: Jam nut with O-ring for rear panel mounting, square flange for front or rear panel mounting, or in-line receptacles for free-hanging cables.

Two Shell Styles: Choose integral band platform for direct attachment of a cable shield. Install a boot, or overmold a boot over the band platform. An accessory thread is available for attaching strain reliefs and backshells.

Gold-Plated Crimp Contacts are held in place with beryllium copper retention clips. Contacts are removable.

How To Order						
Sample Part Number	805-004	-02	NF	9-10	P	A
Series (See Table I)	805-003 = Receptacle with Banding Platform 805-004 = Receptacle with Accessory Thread					
Shell Style (See Table II)	-01 = In-line -02 = Square Flange Front or Rear Mount -12 = Square Flange Rear Mount Non-Locking Clinch Nuts -22 = Square Flange Rear Mount Locking Clinch Nuts -07 = Jam Nut for Rear Panel Mounting					
Shell Material and Finish	C = Aluminum / Black Anodize (Non-Conductive); RoHS Compliant M = Aluminum / Electroless Nickel; RoHS Compliant MT = Aluminum / Nickel-PTFE RoHS Compliant NF = Aluminum / Cadmium with Olive Drab Chromate ZNU = Aluminum / Zinc-Nickel with Black Chromate Z1 = Stainless Steel / Passivated; RoHS Compliant ZB = Stainless Steel / Olive Drab Chromate over Cadmium ZC = Stainless Steel / Zinc Cobalt Alloy/Black Chromate					
Shell Size - Insert Arrangement	See Contact Arrangements Page H-2					
Contact Type	With contacts P = Pin S = Socket	Without contacts A = Pin Connector, less contacts B = Socket Connector, less contacts	With 30 AWG Crimp Barrel G = #23 Pin H = #23 Socket			
Shell Key Positions (See Table III)	A = Normal B = Pos. B C = Pos. C D = Pos. D E = Pos. E F = Pos. F					

Table I: Series	
805-003 Receptacle with Banding Platform	805-004 Receptacle with Accessory Thread

Table II: Shell Style		
-01 In-line Receptacle	-02, -12, -22 Square Flange	-07 Jam Nut

Dimensions in Inches (millimeters) are subject to change without notice.



Series 805 Mighty Mouse Triple-Start Threaded Coupling Contact Arrangements

Contact Arrangements						
Contact Arr.	No. of Contacts					
	#23	#20	#20HD	#16	#12*	#8
8-1				1		
8-23			3			
8-4	4					
8-6	6					
8-7	7					
9-1					1	
9-25			5			
9-10	10					
10-2				2		
10-28			8			
10-13	13					
10-200	4	2				
11-4				4		
11-210			10			
11-19	19					
11-200	4			2		
11-201	8	2				
12-2					2	
12-5				5		
12-26	26					
12-200	12				1	
12-201	4				2	
12-202	8			2		
13-31	31					
15-2					2	
15-3					3	
15-7				7		
15-220			20			

Mating Face View of Pin Connector (socket connector numbers are reversed)

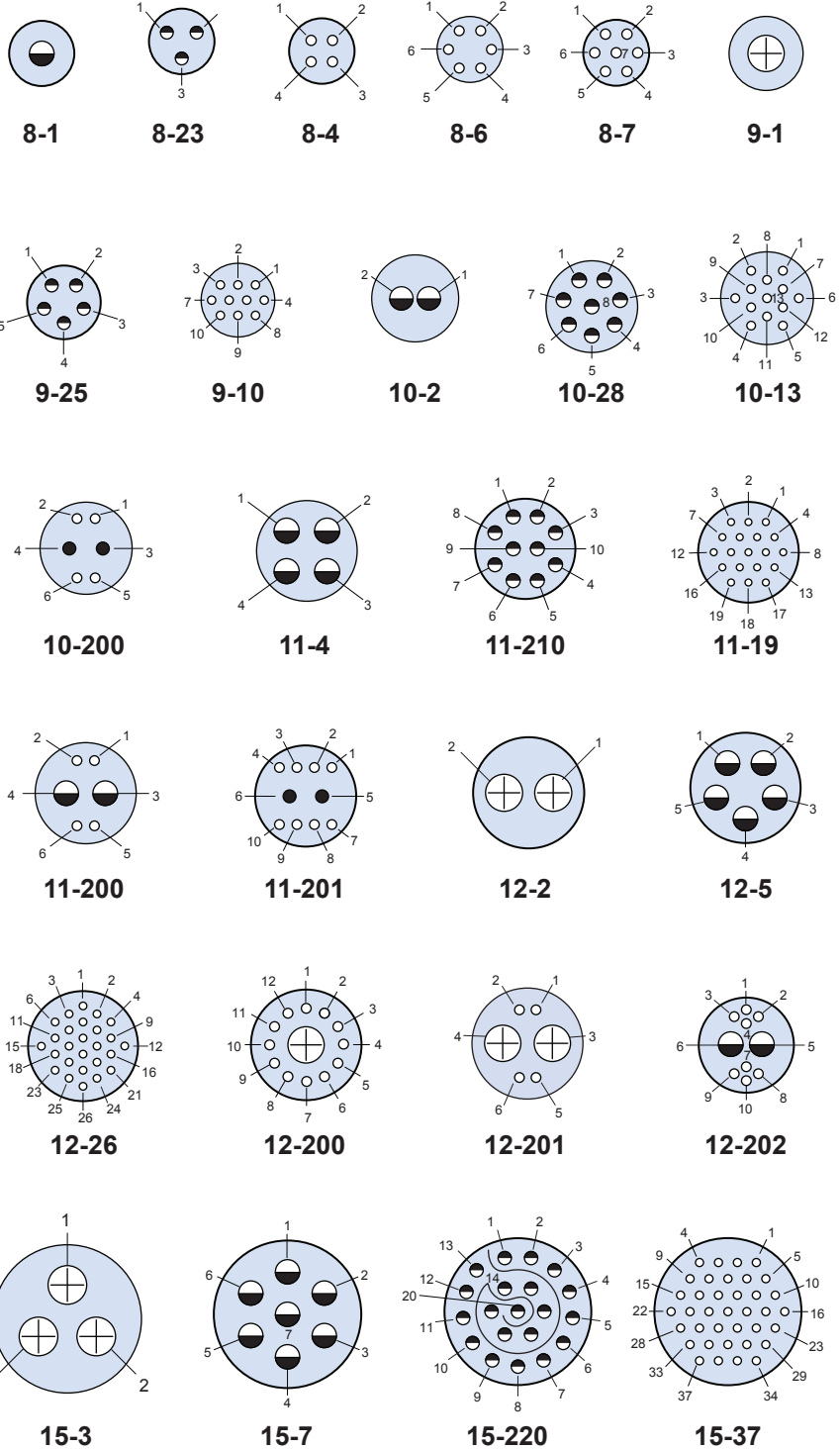

*All arrangements with #12 contacts available with keyed Twinax contacts. Use mode code -688

Contact Legend

#23 ◦ #20HD ◐ #20 ● #16 ◑ #12 ⊕

H

Dimensions in Inches (millimeters) are subject to change without notice.

Series 805 Mighty Mouse Triple-Start Threaded Coupling Contact Arrangements



Series 805

Contact Arrangements						
Contact Arr.	No. of Contacts					
	#23	#20	#20HD	#16	#12*	#8
15-37	37					
15-200	6				2	
15-201	10				2	
15-202	20			2		
15-203	12			4		
15-204	12				2	
15-205	4				4	
18-5					5	
18-12				12		
18-235			35			
18-55	55					
18-204	40			2		
18-205	32			4		
18-206	34			2		
18-207	20			4		
18-208	32					1
19-7					7	
19-14				14		
19-241			41			

Mating Face View of Pin Connector (socket connector numbers are reversed)

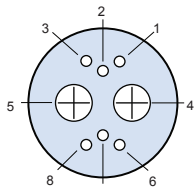

15-200

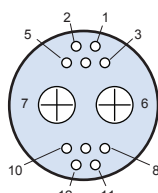

15-201

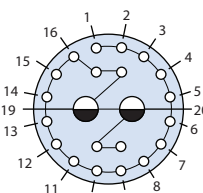

15-202

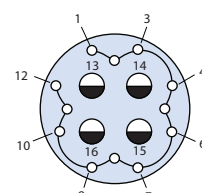

15-203

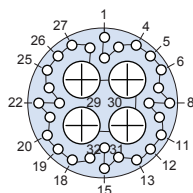

15-204

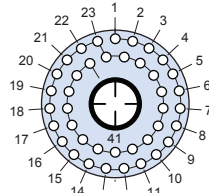

15-205

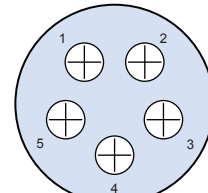

18-5

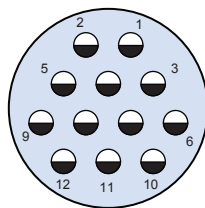

18-12

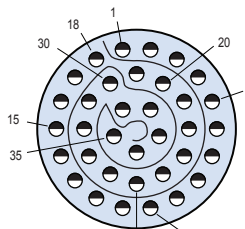

18-235

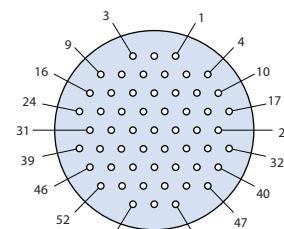

18-55

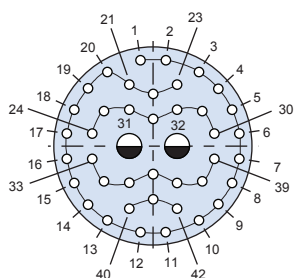

18-204

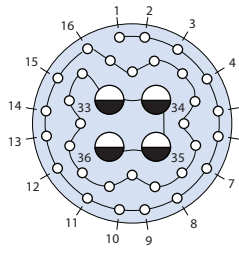

18-205

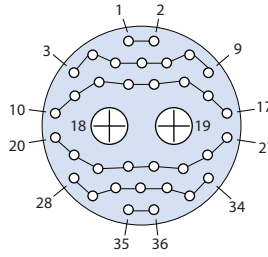

18-206

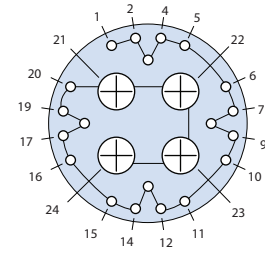

18-207

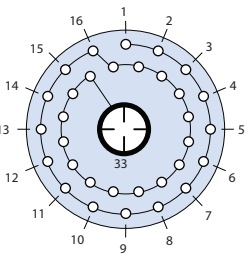

18-208

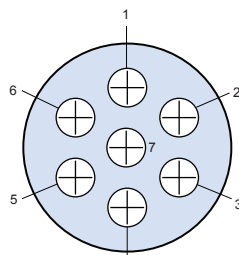

19-7

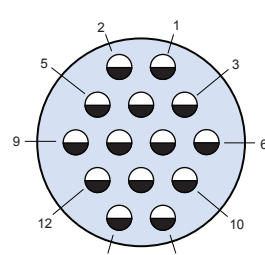

19-14

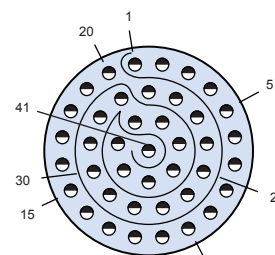

19-241

*All arrangements with #12 contacts available with keyed Twinax contacts. Use mode code -688

Contact Legend

#23 ◦ #20HD ◐ #20 ● #16 ◑ #12 ⊕

Dimensions in Inches (millimeters) are subject to change without notice.





Series 805 Mighty Mouse Triple-Start Threaded Coupling Contact Arrangements

Contact Arr.	No. of Contacts					
	#23	#20	#20HD	#16	#12*	#8
19-85	85					
19-203	40			4		
19-204	28				4	
19-205						
21-19				19		
21-255			55			
21-100	100					
21-201	44					2
21-202	12					4
23-12					12	
23-22				22		
23-269			69			
23-130	130					
23-200	28					4

Mating Face View of Pin Connector
(socket connector numbers are reversed)

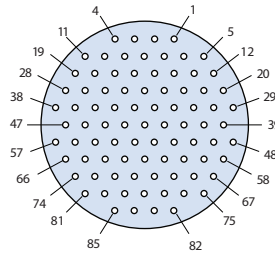

19-85

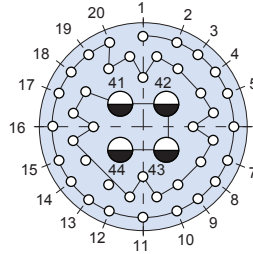

19-203

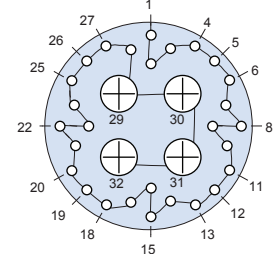

19-204

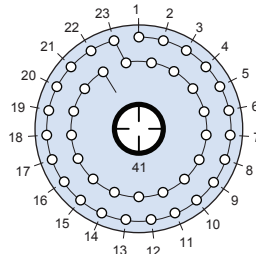

19-205

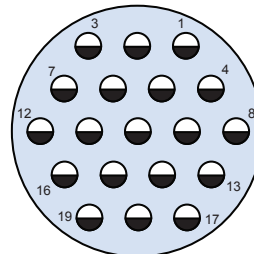

21-19

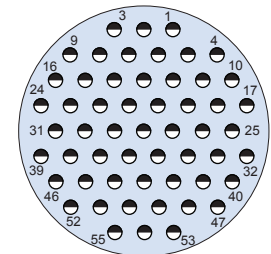

21-255

*All arrangements with #12 contacts available with keyed Twinax contacts. Use mode code -688

Contact Legend

#23 ◦ #20HD ◐ #20 ● #16 ◑ #12 ⊕

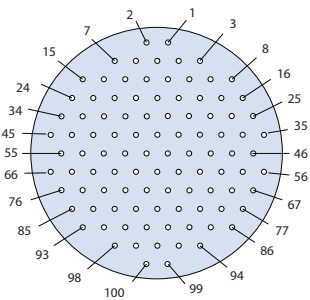

21-100

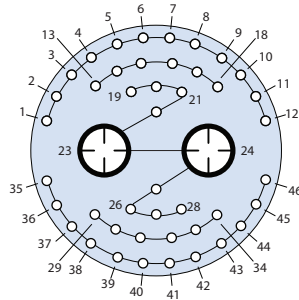

21-201

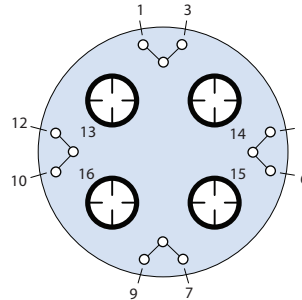

21-202

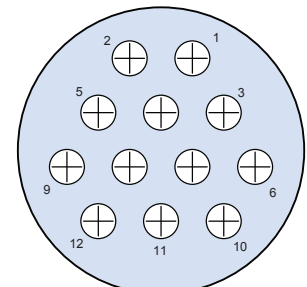

23-12

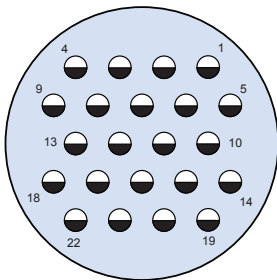

23-22

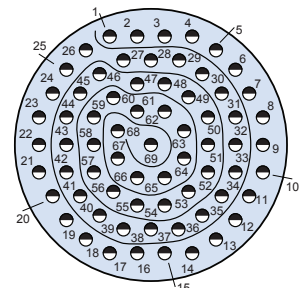

23-269

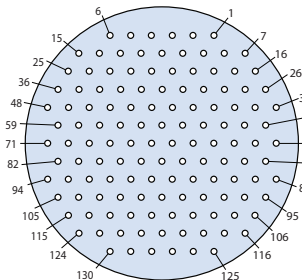

23-130

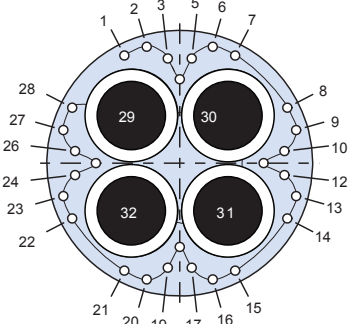

21-200

Dimensions in Inches (millimeters) are subject to change without notice.

Series 805 Mighty Mouse Triple-Start Threaded Coupling General Information



Series 805

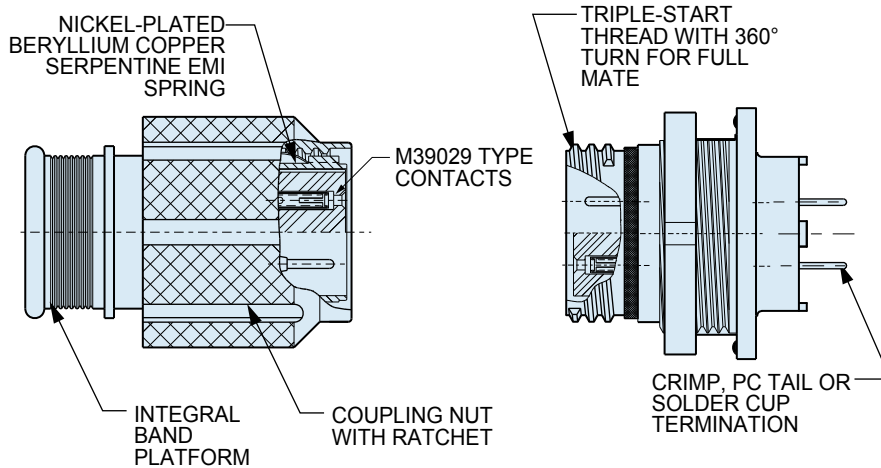

Outstanding EMI Shielding

Nickel-plated beryllium copper ground spring and metal-to-metal bottoming for excellent EMI performance.

Triple-Start Coupling

Rugged ACME threads resist cross-threading and allow fast mating.

Environmentally Sealed

Meets MIL-STD-810 Method 512 immersion.

Ratchet Mechanism

Ratcheting anti-decoupling mechanism prevents coupling nut backoff when subjected to vibration.

Glenair's Series 805 Connector Offers Outstanding EMI Protection and Vibration Resistance in a Miniaturized Package

The Series 805 connector was developed to provide several performance enhancements compared to other "Mighty Mouse" versions. A ratchet mechanism in the coupling nut prevents de-mating under severe vibration. EMI performance is improved with a serpentine ground spring on the plug barrel. This nickel plated beryllium copper spring assures low shell-to-shell resistance. The Series 805, although larger than other Series 80 versions, saves size and weight compared to MIL-DTL-38999 connectors with no compromise in performance.



Specifications	
Current Rating	#23-5 A, #20HD-7.5 A, #16-13 A, #12-23 A
Dielectric Withstanding Voltage	#23-750 VAC, #20HD-1000 VAC #12 and #16-1800 VAC
Insulation Resistance	5000 megohms minimum
Operating Temperature	-65° C. to +175° C.
Shock	300 g.
Vibration	37 g.
Shielding Effectiveness	55 dB minimum low frequency from 100MHz to 1000MHz. and 65 dB minimum high frequency from 1 GHz to 10GHz.
Magnetic Permeability	2.0 μ maximum
Durability	2000 mating cycles

Materials and Finishes	
Shells, Jam Nuts	Aluminum alloy or stainless steel
Contacts	Copper alloy, 50 μlnc gold plated
Insulators	Liquid crystal polymer (LCP)
Contact Retention Clip	Beryllium copper alloy
Seal, O-rings, Grommet	Fluorosilicone rubber
Spring	Nickel-plated beryllium copper
See Series 80 General Information for complete material and finish specs.	

Dimensions in Inches (millimeters) are subject to change without notice.