

SERIES 76
SPST Rocker

FEATURES

- Raised and Recessed, Rocker and PIANO-DIP® Styles
- Sealed Base Standard
- Spring and Ball Contact
- Top Tape Seal Option

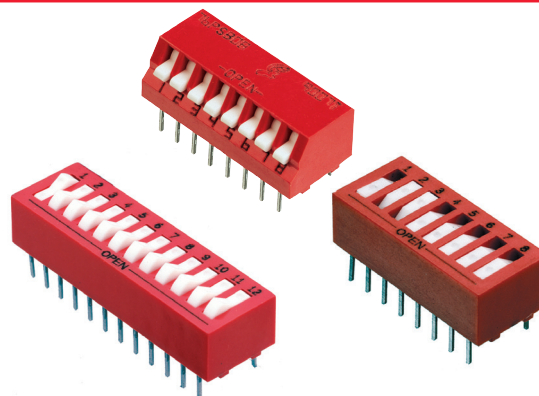

DIP Switches

DIMENSIONS in inches (and millimeters)

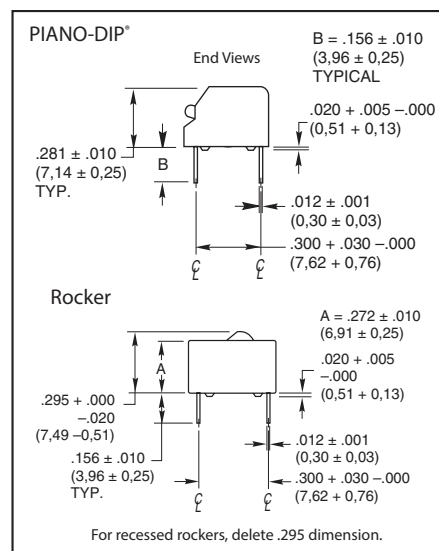
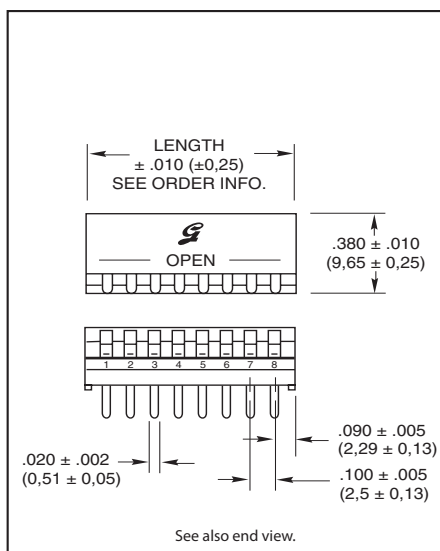
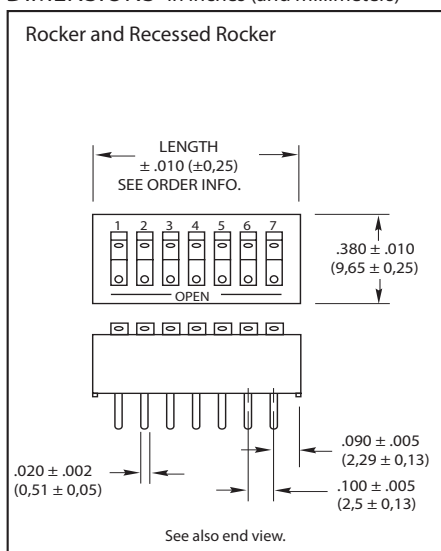

CIRCUITRY

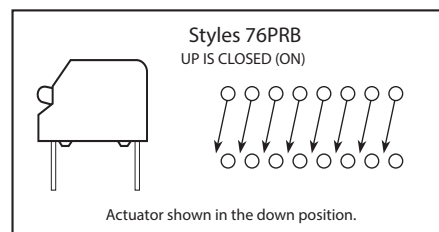
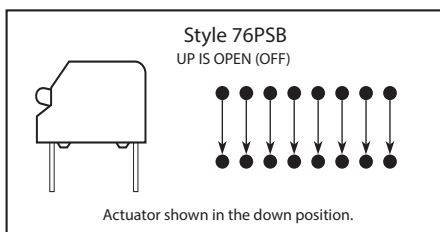
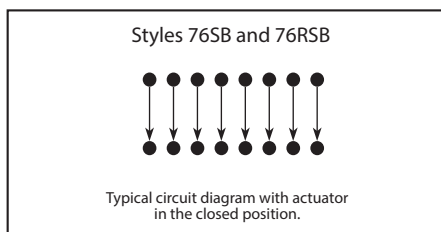

ORDERING INFORMATION

Series

Switch Style: SB = Raised Rocker
RSB = Recessed Rocker
PSB = Piano-DIP (Up is Off)
PRB = Piano-DIP (Up is On)

76RSB04ST

T = RoHS compliant
Sealed*: S = Tape Seal
Number of Positions: 02 through 10, 12

No. of Pos.	Length (Inches)	Length (Metric)	No./Tube
2	0.280"	7,1 mm	35
3	0.380"	9,7 mm	27
4	0.480"	12,2 mm	21
5	0.580"	14,7 mm	18
6	0.680"	17,3 mm	15
7	0.780"	19,8 mm	13
8	0.880"	22,4 mm	12
10	1.080"	27,4 mm	9
12	1.280"	32,5 mm	8

*A top tape seal is required for switches that are machine soldered or heavily cleaned after hand soldering. To order top seal versions, add "S" to the Grayhill part number.

Available from your local Grayhill Distributor.
For prices and discounts, contact a Local Sales Office,
an authorized local Distributor or Grayhill.