

5

4

3

2

1

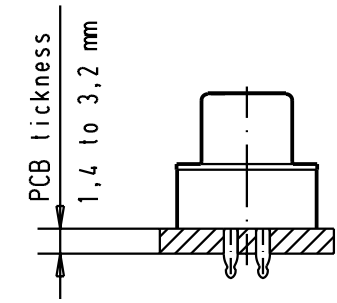
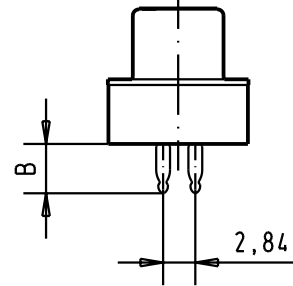
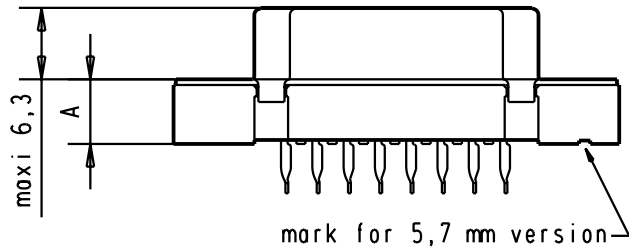

PCB layout hole component side
(PCB holes plating : Tin)

Mating face according to : MIL-C-24308 / DIN 41652 / CECC 75301-802

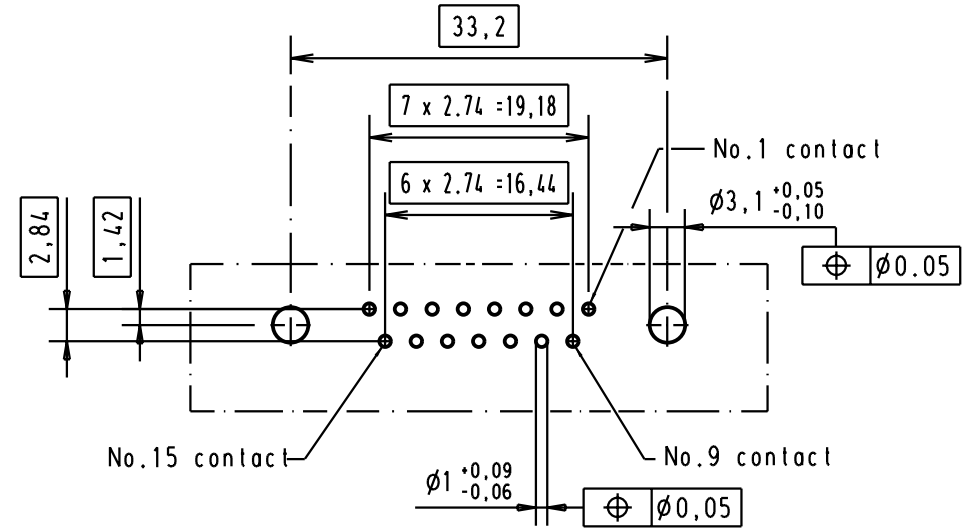
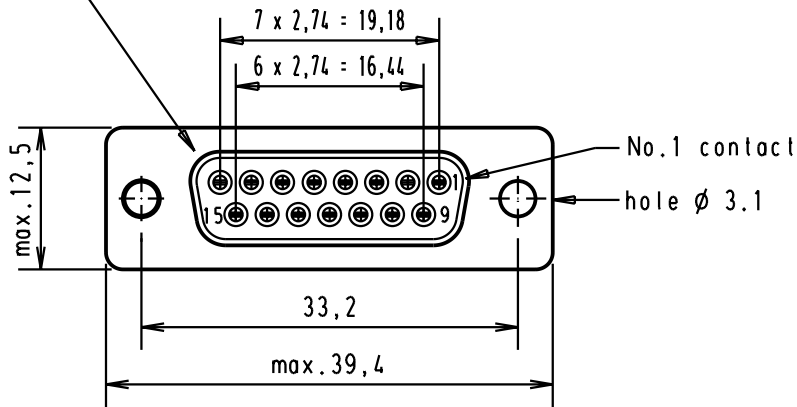

09662147500	3	6	4.20																
09662146500	2	6	4.20																
09662145500	0.76 µm Au	6	4.20	31079	29-AUG-02	CV	Detail.	30/03/94	jfb										
09662147504	3	5.7	4.35	27980	05/03/01	jfb	Insp.												
09662146504	2	5.7	4.35	26574	14/02/00	jfb	Stand.												
09662145504	0.76 µm Au	5.7	4.35	16236	30/06/95	jfb													
Part number	Performance level	A±0.2	B±0.2	Mod.	Dat.	Name	HARTING EURL F-95972 Paris						TB 0966214x50x			Maßstab/ Scale 2,5:1 Blatt/ Page 1/			

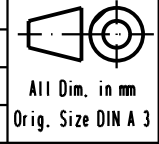

D-Sub 15 poles straight female connector with press-in termination, version ø 3.1 hole.

Moßstab/
Scale
2,5:1

Blatt/ Page
1/

TB 0966214x50x

Sub.