

## Features

### 1. Enhanced contact reliability and lock structure

The unique locking structure reinforces the engagement between the wire side portion and the header. This prevents the wire side from becoming misaligned due to stress from poorly routed wiring. (Figure 1) (Patent pending)

### 2. Vertical mating provides superior handling

The use of vertical mating style reduces assembly time and maximizes precious board space which gives designers more freedom when designing other components on the PCB. (Figure 2)

### 3. Highly reliable contact structure

The two point contact structure provides optimum reliability, a low mated height of 1.8 mm and an effective mating length of 0.35 mm.

### 4. Increased cable retention

The header is designed to press the terminal lance down during the mating operation; this prevents the lance from moving and enhances its strength.

### 5. High current of MAX 4A(AWG24)

By utilizing highly conductive material for the female terminals and suppressing the contact resistance, the DF65 series can handle a maximum of 4 A with AWG #24 wire.

### 6. Solder wicking prevention

Molding is done in a way that removes the gap between the contacts and the housing to prevent wicking.

### 7. Prevents Accidental unmating

The molded structure is designed to prevent accidental unmating due to poorly routed wiring and harsh loads.

## Lock structure and operation

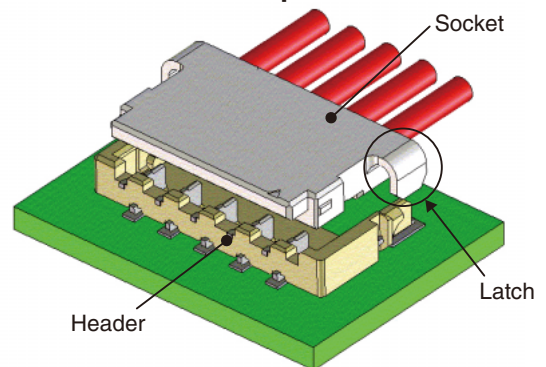

Latches are deflected slightly during mating.

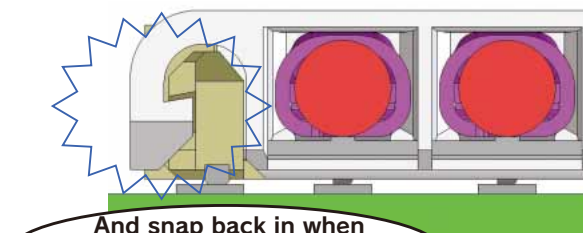
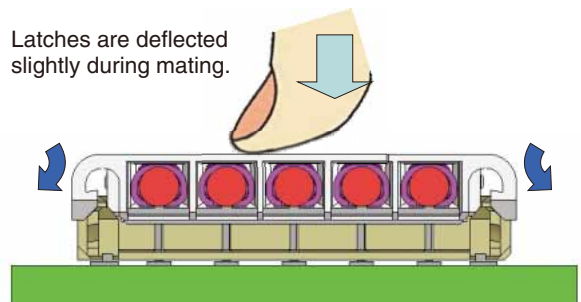

And snap back in when mating is complete.  
A click feeling will be felt!

Figure 1

## Vertical mating provides superior operability and maximizes board space.

### Vertical mating type

Side view of the PCB

Vertical mating style allows other parts to be mounted.  
(Enhances freedom in designing PCB)

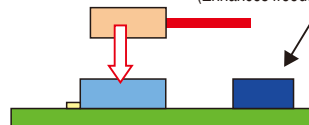

The mating face is easy to see, resulting in proper insertion.

### Horizontal mating type

Unused, open area

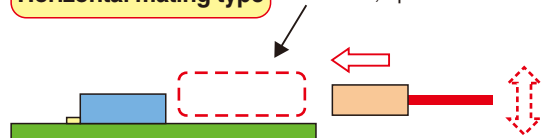

The mating face can be hard to see, which can lead to awkward insertion.

Figure 2

## Product Specifications

Ratings	Current Rating	4 A/pin (when 24 AWG is used) (Note 1)	Operating Temperature Range Operating Humidity Range	- 35 ~ + 105°C (Note 2) 20 ~ 80% (Note 3)
	Voltage Rating	AC / DC 50 V	Storage Temperature Range Storage Humidity Range	- 10 ~ + 60°C (Note 4) 40 ~ 70% (Note 4)

Item	Specifications	Conditions
1. Insulation resistance	No less than 100 MΩ	Measured at DC 100 V
2. Withstand voltage	No flashover or breakdown	AC 500 V is applied for one minute.
3. Contact resistance	No more than 10 MΩ	Measured at 1 mA and no higher than 20 mV
4. Vibration Resistance	No electrical discontinuity of 1 μs or greater	10 cycles in each of three directions at frequency 10-55 Hz, half amplitude 0.75 mm
5. Shock Resistance	No electrical discontinuity of 1 μs or greater	Accelerated velocity: 490 m/s <sup>2</sup> , for 11 ms, half-sine in 3 directions, 3 times for each of the three directions
6. Moisture-resistance	Contact resistance: no more than 20 mΩ; insulation resistance: no less than 500 MΩ	Temperature: 40 ± 2°C; humidity: 90 to 95%, left as it is for 96 hours
7. Temperature cycles	Contact resistance: no more than 20 mΩ; insulation resistance: no less than 500 MΩ	-55°C: 30 minutes → 5 - 35°C: 2 - 3 minutes → 85°C : 30 minutes → 5 - 35°C: 2 - 3 minutes) 5 cycles
8. Durability	Contact resistance: no more than 20 mΩ	30 mating cycles
9. Resistance to solder heat	The resin components will not become deformed or lose performance due to deformities	Reflow: according to the Recommended Temperature Profile Hand soldering: temperature of soldering iron at 350°C ± 10°C for 3 seconds

(Note 1) This is the maximum current rating while all pins are powered or used as all power lines. If you split the current over multiple lines, please factor in your own safety margin. Please contact Hirose Electric, for inquiries on the assignment of pins and on the currents that can be delivered.

(Note 2) Includes the temperature rise of power lines.

(Note 3) Use without condensation on parts.

(Note 4) The storage condition refers to long-term storage of the product on the shelf before assembly. Please use the operating temperature for temporary storage such as pre-assembly and during shipping.

## Materials

Product	Part	Materials	Finish	UL specification
Header	Insulator	LCP	Black	UL94V-0
	Contact	Brass	Tin Plating	-
Crimp socket	Insulator	LCP	Beige	UL94V-0
Crimp contact	Contact	Phosphorous Bronze	Tin Plating	-

## Product Number Structure

Refer to the charts below for determining specific part number characteristics.

Please select connectors listed in this catalog when placing orders and be sure to check the latest delivery specifications at the time of ordering the product.

### ● Header connector

**DF 65 - \* P - 1.2 V**

① ② ③ ④ ⑤ ⑥

① Series Name : DF	⑥ Mounting style V : SMT Straight Type
② Series No. : 65	
③ Number of contacts : 3, 4, 5, 6, 8, 10	
④ Connector type P: Header	
⑤ Pitch : 1.7mm	

### ● Socket connector

**DF 65 - \* S - 1.2 C**

① ② ③ ④ ⑤ ⑥

① Series Name : DF	⑤ Pitch : 1.7mm
② Series No. : 65	
③ Number of contacts: 3, 4, 5, 6, 8, 10	
④ Connector type S : socket	
⑥ Termination form C : crimp case	

### ● Crimp contact

**DF 65 - 2428 SCF**

① ②

① Applicable wire size 2428 : AWG24~AWG28	② Packaging style SCF: Socket contact on reel
--	--

## Straight pin header

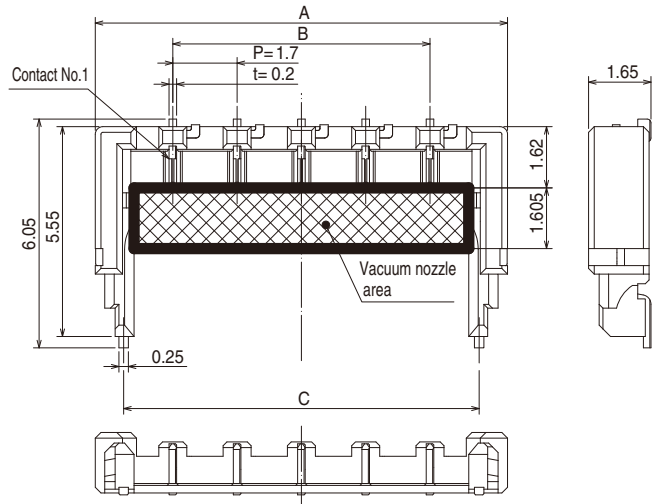

### Recommended PCB layout (t=1 mm)

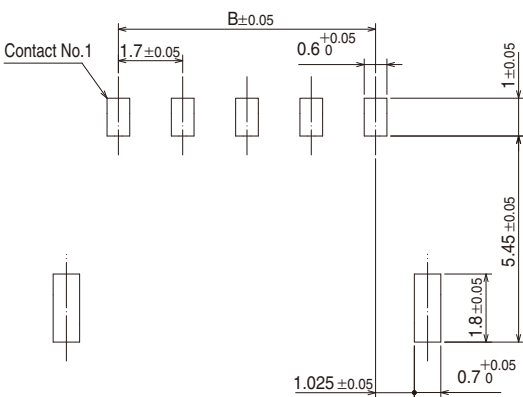

[Specification Number]  
(21): Tin plating, embossed packaging

Part Number	HRS No.	No. of Contacts	A	B	C
DF65-3P-1.7V (21)	666-6004-5-21	3	7.5	3.4	6
DF65-4P-1.7V (21)	Under development	4	9.2	5.1	7.7
DF65-5P-1.7V (21)	666-6001-7-21	5	10.9	6.8	9.4
DF65-6P-1.7V (21)	666-6008-6-21	6	12.6	8.5	11.1
DF65-8P-1.7V (21)	Under development	8	16	11.9	14.5
DF65-10P-1.7V (21)	Under development	10	19.4	15.3	17.9

(Note) This product is sold per reel with 4,000 connectors per reel. Please order by reel quantities.

### Tape and Reel Dimensions

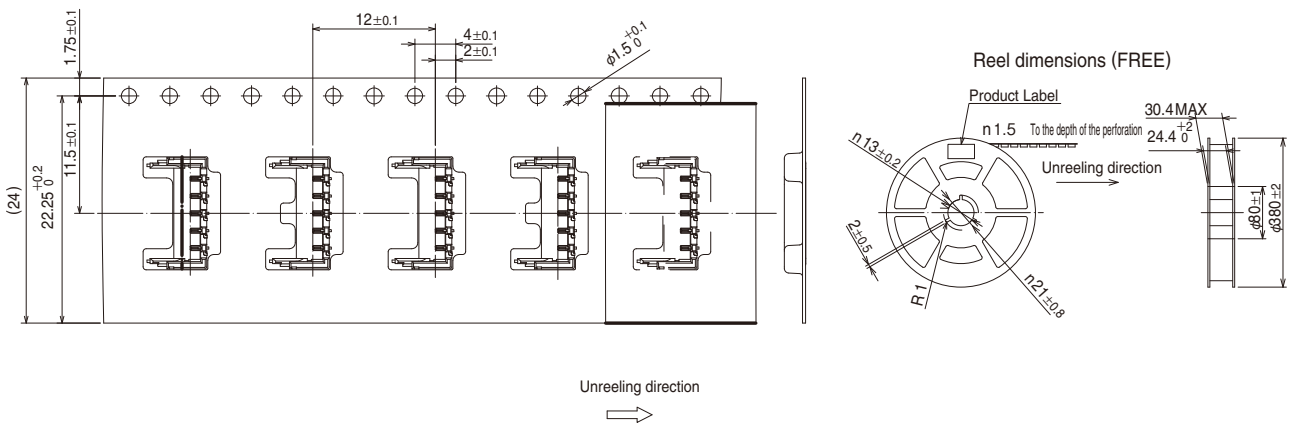

## ■ Crimp socket

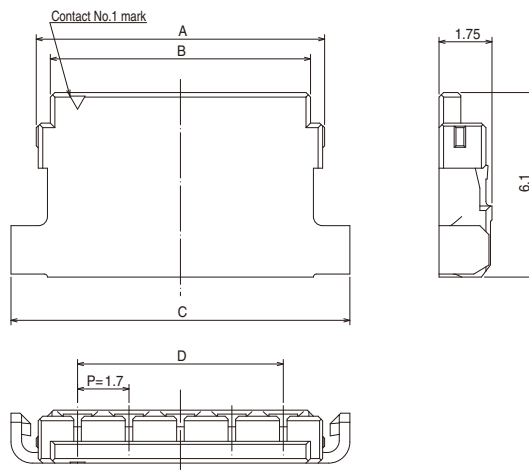

Part Number	HRS No.	No. of Contacts	A	B	C	D
DF65-3S-1.7C	666-6005-8-00	3	6.13	5.2	7.8	3.4
DF65-4S-1.7C	Under development	4	7.83	6.9	9.5	5.1
DF65-5S-1.7C	666-6002-0-00	5	9.53	8.6	11.2	6.8
DF65-6S-1.7C	666-6009-9-00	6	11.23	10.3	12.9	8.5
DF65-8S-1.7C	Under development	8	14.63	13.7	16.3	11.9
DF65-10S-1.7C	Under development	10	18.03	17.1	19.7	15.3

[Specification Number]  
None: 1 package  
contains 100 pieces

(Note) Each package contains 100 pieces. Please order in full package quantities.

## ■ Crimp contact

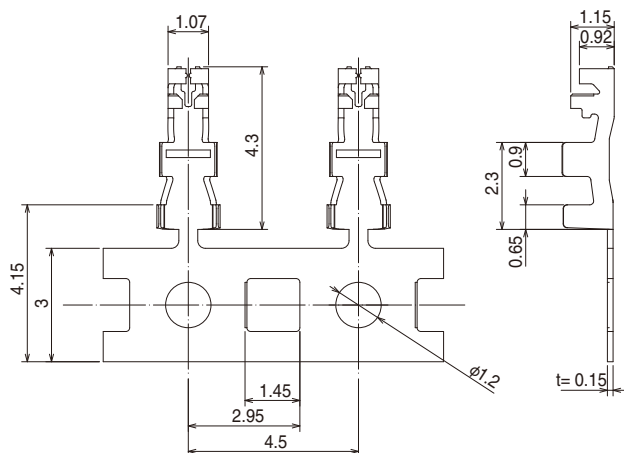

[Specification Number]  
None: 18,000 pieces per reel

Part Number	HRS No.	Description	Quantity	Finish	RoHS
DF65-2428SCF	666-0003-2-00	Reel contact	18,000 pieces per reel	Tin Plating	○

(Note) This product is sold per reel (40,000 connectors per reel), please order by reel quantities.

### ● Applicable wire (Tinned, annealed copper wire)

Conductor size (Core structure)	Jacket Diameter
24 AWG (11 pieces/φ 0.16 mm)	φ1.11mm
26 AWG (7 pieces/φ 0.16 mm)	φ0.98mm
28 AWG (7pieces/φ 0.127 mm)	φ0.88mm

### ● Recommended wire

UL10368

### ● Strip length

1.4~1.8mm

(Note) Please contact your local Hirose sales rep if you plan on using wires other than those listed above.

## ◆ Tooling Information

Item	Part Number	HRS No.	Applicable contact
Applicator	AP105-DF65-2428S	CL901-4630-0-00	DF65-2428SCF
Press body	CM-105	CL901-0005-4-00	—
Hand tool	HT305/DF65-2428S	CL550-0306-8-00	DF65-2428SCF
Extraction tool	DF-C-PO (B)	CL550-0179-2-00	DF65-2428SCF

(Note) Hirose does not cover damage created by the use of unapproved Hirose Tools. Please contact your local Hirose Sales for clarification.

## ◆ Precautionary notes

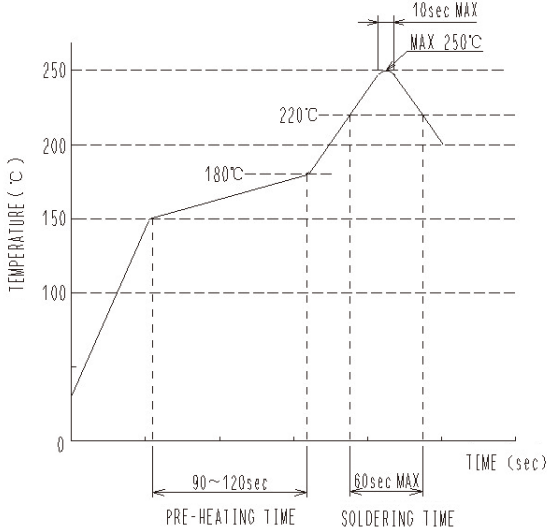
<p>1. Recommended Soldering Profile (Compatible with lead-free soldering)</p>	 <p><b>[Applicable Conditions]</b></p> <ol style="list-style-type: none"> <li>1. Peak temperature : MAX 250°C</li> <li>2. Heating Area: 220°C or above, within 60sec .</li> <li>3. Preheating Area: 150~180°C , 90~120 sec.</li> </ol> <p>* Measurement is conducted at the contact lead part Please check the mounting conditions before use, conditions such as solder paste types, manufacturer, PCB size and any other soldering materials may alter the performance of such materials. (Note 1) This temperature profile is a recommended value only; please contact your Hirose Sales Rep for more information</p>
<p>2. Recommended hand soldering conditions</p>	<p>Temperature of soldering iron: 350±10°C, soldering time: no more than 3 seconds</p>
<p>3. Recommended screen thickness, aperture ratio (pattern surface ratio)</p>	<p>Thickness: 0.1 mm, aperture opening ratio: 100%</p>
<p>4. Warping of PC Board</p>	<p>A maximum of 0.02 mm at the center of connector, as measured from either end of the connector</p>
<p>5. Cleaning Conditions</p>	<p>IPA cleaning is allowed. (Cleaning is not recommended because cleaning may change the push/pull feeling etc. Please contact your local Hirose representative prior to the use of any cleaning agents.)</p>
<p>6. Precautions</p>	<ul style="list-style-type: none"> <li>■ When inserting the crimp contact into the crimp socket, do not insert it at a slanted angle to maintain the reliability of its performance.</li> <li>■ Please use caution when mating/unmating this connector if it has not been mounted onto the PCB, doing so could deform or damage the contacts.</li> <li>■ Do not pull on the wires of this connector as this may cause damage to the connector.</li> <li>■ During the hand soldering process, make sure to not apply too much flux. Doing so may cause a solder wicking problem.</li> <li>■ This product may experience some differences in color from one production lot to another. This color difference does not influence the performance of the connector.</li> <li>■ For handling precautions to be used during the insertion/removal process, please refer to the “DF65 Push-pull procedure”.</li> </ul>

7. Mating and Unmating Operation

**Mating operation**

① Align the receptacle over the header

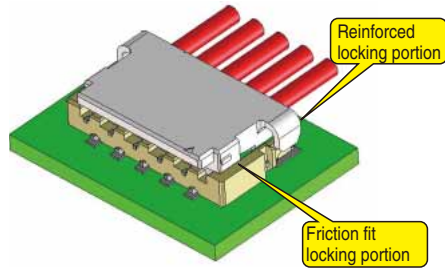

② Insert and press down on the receptacle in the direction of the arrow.

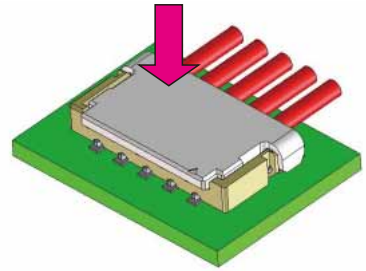

③ Completed mating operation

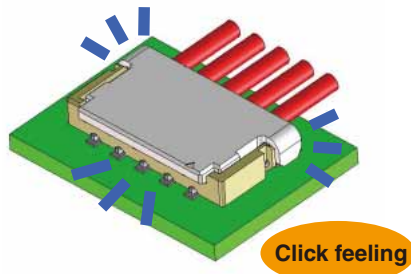

**Unmating operation**

① Start by lifting up on the front edge of the receptacle.

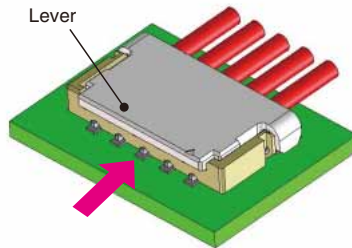

② Pull it upward to release the friction fit lock portion.

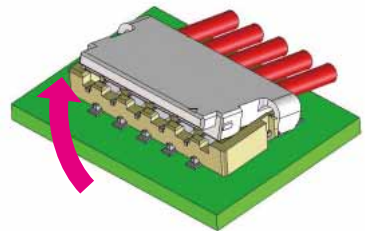

③ Reinforced lock portion will then be released. Continue lifting the receptacle in an upward direction.

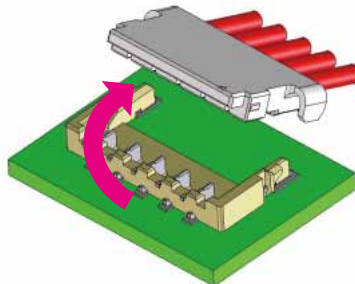

**HIROSE ELECTRIC CO.,LTD.**

6-3,Nakagawa Chuoh-2-Chome,Tsuzuki-Ku,Yokohama-Shi 224-8540,JAPAN  
 TEL: +81-45-620-3526 Fax: +81-45-591-3726  
<http://www.hirose.com>  
<http://www.hirose-connectors.com>