



Quality Products. Service Excellence.

Type 4, 4X Stainless Steel Pushbutton Enclosures *1435SS Series*



Application

- Designed to accept standard heavy duty oil tight pushbuttons, switches and pilot lights.
- Provides protection from dirt, dust, oil and large amounts of water from any angle, or where highly corrosive conditions exist.

Standards

- UL 508A Type 4 and 4X
- CSA Type 4 and 4X
- **Complies with**
 - NEMA Type 3R, 4 and 4X
 - JIC Standard EGP-1-1967
 - IEC 60529, IP66
- Appropriate components are required to maintain these standards.

Construction

- Formed 14 gauge stainless steel except A and B which are 16 gauge. 304 or 316 SS.
- Smooth continuously welded seams.
- Welded brackets provide for enclosure mounting.
- Captive stainless steel cover screws thread into sealed wells.
- Larger enclosures provide internally hinged removable covers, designed to hold the cover open during wiring.
- Oil resistant gasket and adhesive.
- A bonding stud is provided on the door and a grounding stud is provided on the enclosure.

Finish

- Natural stainless steel with a smooth brushed finish.

Accessories

- Hole Plugs
- Ground Wire Kits

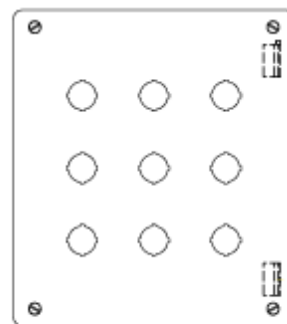
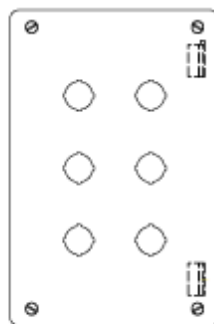
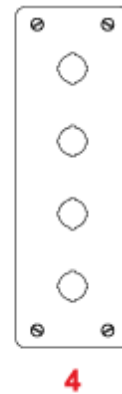
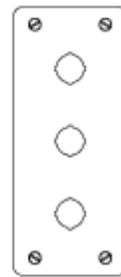
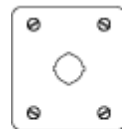
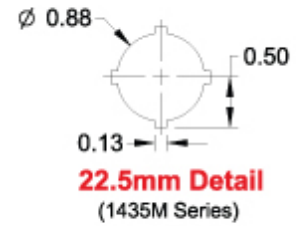
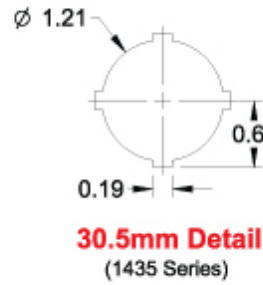
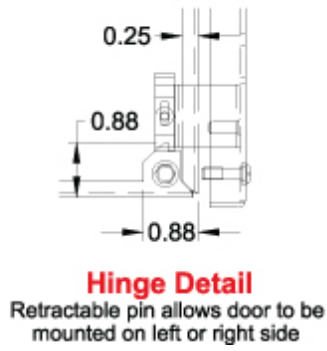
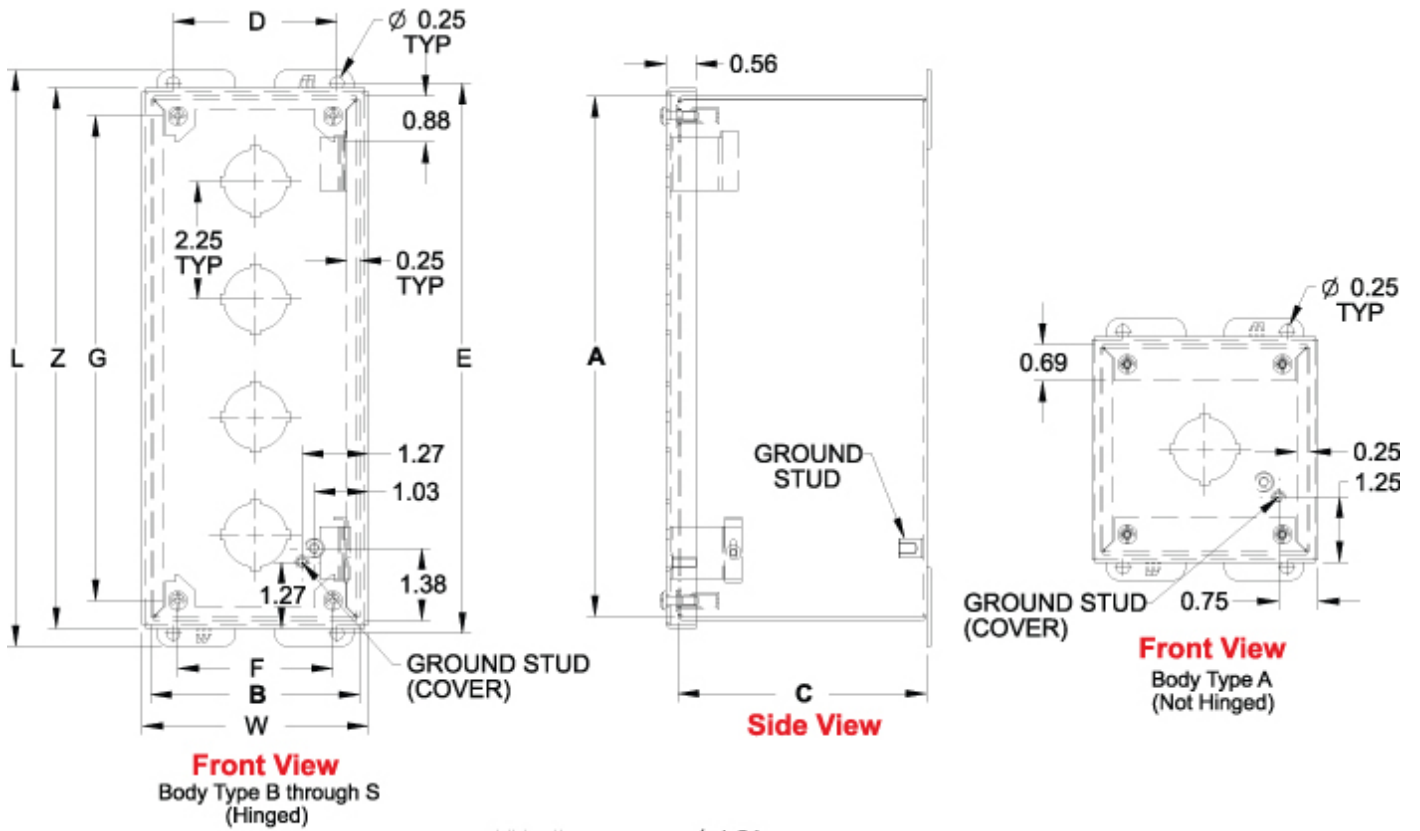

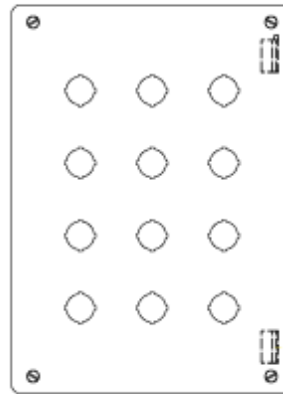

12

304 S.S. 22.5mm	Part No.			No. Of Holes								Overall Dimensions		
	304 S.S. 30.5mm	316 S.S. 22.5mm	316 S.S. 30.5mm		A	B	C	D	E	F	G	L	W	Z
1435MSSA ¹	1435SSA ¹	1435MS16A ¹	1435S16A ¹	1	3.50	3.25	2.75	2.38	4.00	2.21	2.75	4.50	3.56	3.81
1435MSSB ¹	1435SSB ¹	1435MS16B ¹	1435S16B ¹	2	5.75	3.25	2.75	2.38	6.25	2.21	5.00	6.75	3.56	6.06
1435MSSC ¹	1435SSC ¹	1435MS16C ¹	1435S16C ¹	3	8.00	3.25	2.75	2.38	8.50	2.21	7.25	9.00	3.56	8.31
1435MSSD ¹	1435SSD ¹	1435MS16D ¹	1435S16D ¹	4	10.25	3.25	2.75	2.38	10.75	2.21	9.50	11.25	3.56	10.56
1435MSSH	1435SSH	1435MS16H	1435S16H	6	9.50	6.25	3.00	5.38	10.00	5.21	8.75	10.50	6.56	9.81
1435MSSK	1435SSK	1435MS16K	1435S16K	9	9.50	8.50	3.00	7.63	10.00	7.46	8.75	10.50	8.81	9.81
1435MSSO	1435SSO	1435MS16O	1435S16O	12	11.75	8.50	3.00	7.63	12.25	7.46	11.00	12.75	8.81	12.06

¹ Not hinged

Data subject to change without notice