

# Micro-USB connectors meeting USB 2.0 Standard

## ZX Series

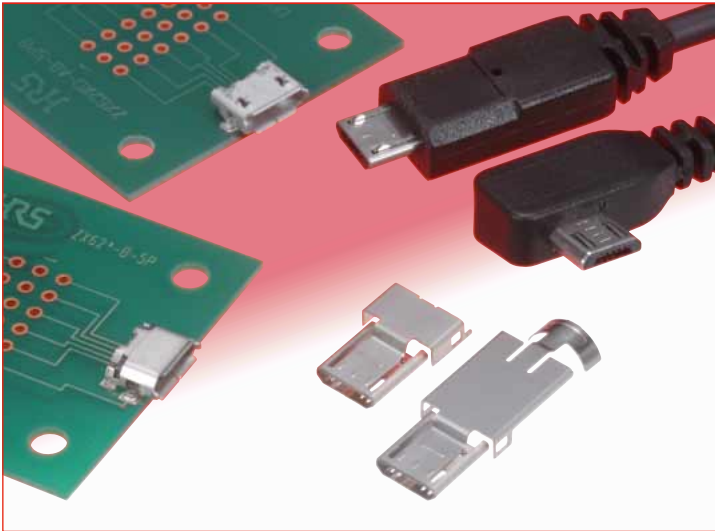

Note: Contact us to ascertain whether a TID number has been acquired for an individual product.

Fig.1

### Overview

Extremely small highly reliable connectors complying with physical, electrical and environmental requirements of Micro-USB standard (USB 2.0).

Receptacles and plugs are available in a wide variety of mounting and termination styles, allowing their use in various applications.

### Features

#### 1. Size reduction

Compared with the standard Mini-USB connectors, the size of ZX connectors is reduced by approximately 60% while still allowing a high-speed data transfer of 480 Mbps, specified in USB 2.0.

#### 2. Receptacle styles

Two interface configurations: Micro-B and Micro-AB in standard, mid-mount and reverse mounting styles. SMT and through-hole (shell) PC board terminations.

#### 3. Plug styles

Corresponding to the receptacle styles, two interface configurations: Micro-A and Micro-B, with direct wire or PCB wire soldering.

Several plug styles can be used for data transmission, earphone or charging applications.

#### 4. Smooth mating and unmating

A smooth mating and unmating operation results in less wear and a longer product life. The unique Hirose active latch mechanism produces a reliable and durable connector.

Even after repeated use, the user will experience a smooth click sensation when mating the connectors.

Note: The statement above only applies when using both plug and receptacles made by Hirose Electric.

#### 5. Hirose was the first company to obtain a Micro-USB certification (TID number).

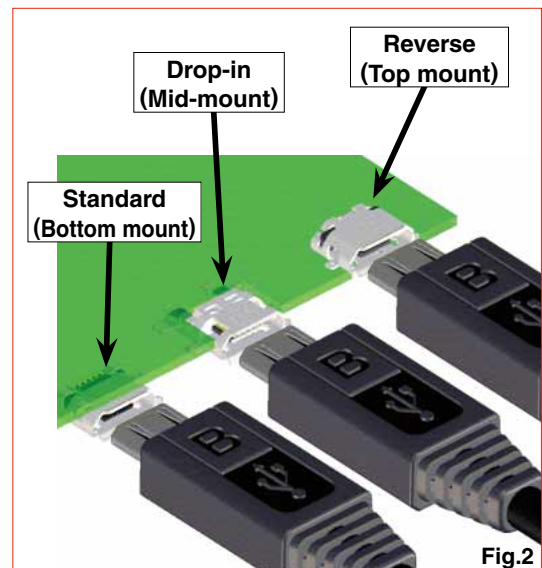

Fig.2

### USB 2.0 Hi-Speed (480 Mbps)

Eye diagram measurement results:  
Measured with 2.4 m long USB 2.0 cable

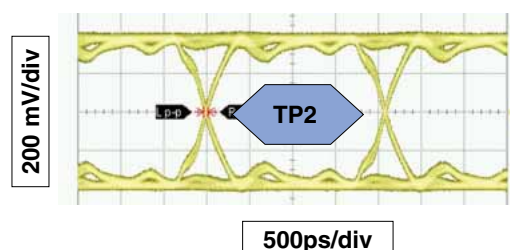

Fig.3

## ■ Specifications

Ratings	Current rating	1 A (per contact) or 1.8 A (contacts No. 1 and 5) and 0.5 A (contacts No. 2, 3, and 4)	Voltage rating	30 V AC
			Operating temperature range	-30°C to +85 °C (Note1)
			Storage temperature range	-30 °C to +60°C

Item	Specification	Conditions
1. Contact resistance	30 mΩ max.	100 mA
2. Withstanding voltage	No flashover or insulation breakdown	100 V AC / 1 minute
3. Capacitance	2 pF max.	Between adjacent contacts at 1,000 Hz (AC voltage)
4. Durability	Contact resistance: Rise from initial value of 10 mΩ max.	10,000 cycles
5. Total insertion/removal force	Insertion force: 35 N max., Removal force: 8 N min.	Mated with corresponding connector

Note1: Includes temperature rise caused by current flow.

Note2: Information contained in this catalog represents general requirements for this Series. Contact us for the drawings and specifications for a specific part number shown.

## ■ Materials

### ● Receptacles

Part	Material	Finish	Remarks
Insulator	LCP	Micro-B: Black, Micro-AB: Gray	UL94V-0
Contacts	Copper alloy	Selective gold plated	————
Shell	Stainless steel	Tin alloy plating	————

### ● Plugs

Part	Material	Finish	Remarks
Insulator	LCP	Micro-B: Black, Micro-AB: Gray	UL94V-0
Contacts	Copper alloy	Selective gold plated	————
Shell	Stainless steel	Tin alloy plating	————

## ■ Ordering information

### ● Receptacles

**ZX 62 RD - B - 5 P \* 8**

① ② ③ ④ ⑤ ⑥ ⑦ ⑧

### ● Plugs

**ZX 40 - B - 5 S \* - UNIT**

① ② ④ ⑤ ⑥ ⑦ ⑨

**ZX 40 - B - SLDA**

① ② ④ ⑨

① Series name	ZX
② Termination style	10's: Right-angle PCB wire, SMT 20's: Straight, PCB wire 40's: Direct wire 60's: Right-angle, PCB wire 80's: Cradle SMT
③ Board mounting style (Receptacles)	Blank Standard (Bottom mount) D Standard (Bottom mount) through hole R Reverse (Top mount) RD Reverse (Top mount) through hole M Drop-in (Mid-mount)
④ Mating side configuration	A Micro-A B Micro-B AB Micro-AB
⑤ Number of contacts	5
⑥ Contact type	P Receptacle- Male S Plug – Female
⑦ Serial No.	
⑧ Shell termination style – Blank Receptacles	SMT 8 Through hole (solder tab length: 0.8mm)
⑨ Components-plugs	UNIT Assembly (Insulator/contact/lock) Cover (Note 1)

Note 1: Classifiers such as A, B, and C are entered for \*.

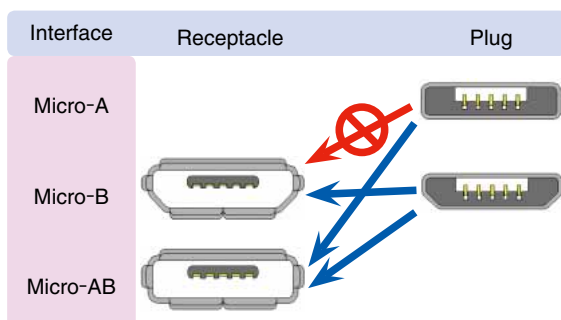

## Configurations

	Mating side configuration	Type	Part No.	3D Image	Page	
R e c e p t a c l e s	Micro-B	Standard	SMT	ZX62-B-5PA(11)		4
			SMT + DIP	ZX62D-B-5PA8		4
		Reverse	SMT	ZX62R-B-5P		5
		Drop-in	SMT	ZX62M-B-5P(01)		5
	Micro-AB	Standard	SMT	ZX62-AB-5PA(11)		6
			SMT + DIP	ZX62D-AB-5P8		6
		Reverse	SMT	ZX62R-AB-5P		7
			SMT + DIP	ZX62RD-AB-5P8		7
P l u g s	Micro-B	Direct wire soldering	Assembly (insulator/contacts/lock) :ZX40-B-5S-UNIT(12) Cover-top :ZX40-B-SLDA Cover-bottom :ZX40-SLDB		9 and 10	
		PCB wire soldering (straight, through hole)	Assembly (insulator/contacts/lock) :ZX20-B-5S-UNIT Cover :ZX20-B-SLDC		11	
		PCB wire soldering (SMT)	Assembly (insulator/contacts/lock) :ZX64-B-5S-UNIT(14) Cover-top :ZX64-B-SLDA Cover-bottom :ZX64-SLDB		12 and 13	
		PCB wire soldering (SMT)	Assembly (insulator/contacts/lock) :ZX64-B-5S-UNIT(14) Cover :ZX64-B-SLDC		12 and 14	
	Micro-A	Direct wire soldering	Assembly (insulator/contacts/lock) :ZX40-A-5S-UNIT Cover-top :ZX40-A-SLDA Cover-bottom :ZX40-SLDB		15 and 16	
C r a d l e s	Micro-B	SMT + DIP	ZX80-B-5S	With lock	17	
			ZX80-B-5SA	Without lock	17	

Note: 1. Part numbers in the Plugs section of the above table list the Assembly (insulator/contacts/locks) and the corresponding Shields/Covers.

Note: 2. Optional Printed Circuit boards for the Plugs are shown for reference only. Not supplied with applicable connectors.

Note: 3. The color of the insulators body in the Assembly (insulator/contacts/lock) shown in the 3D Image column above is blue for clarity. Refer to the Materials (Page 2) for correct colors.

## ■ Receptacles

### ● Micro B - Standard (Bottom mount), Shell SMT

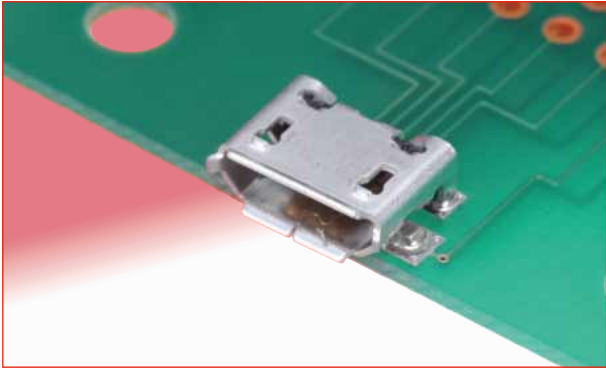

Part No.	HRS No.	Packaging
ZX62-B-5PA(11)	242-0033-8 11	3,500 pcs/reel

### ◆ Recommended PCB mounting pattern



All dimensions: mm

### ● Micro B - Standard (Bottom mount), Shell through hole

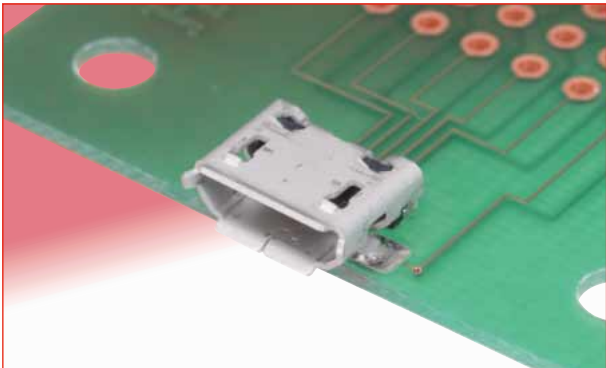

Part No.	HRS No.	Packaging
ZX62D-B-5PA8	242-0056-3	2,000 pcs/reel

### ◆ Recommended PCB mounting pattern

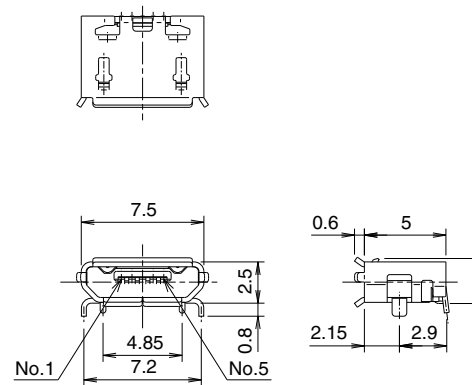
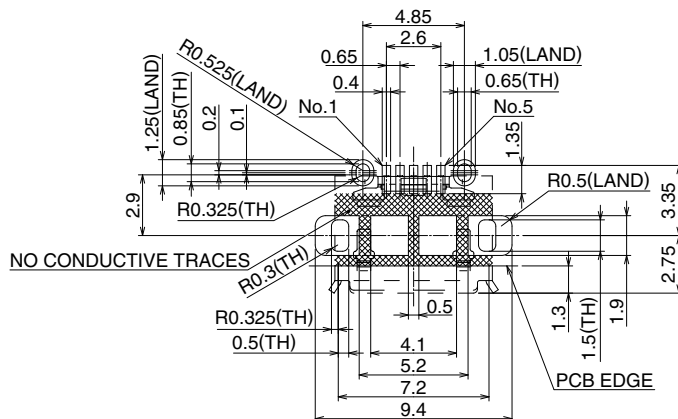

All dimensions: mm

## ■ Receptacles

### ● Micro B - Reverse (Top mount) Shell SMT

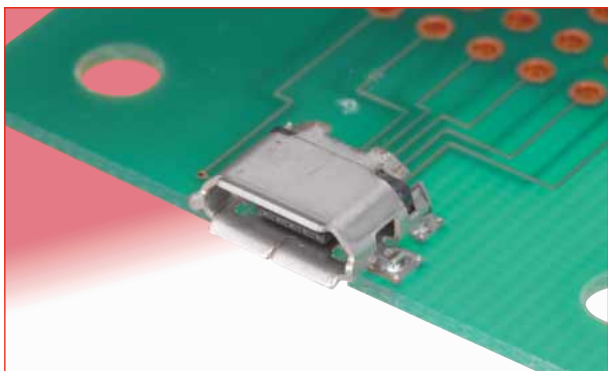

Part No.	HRS No.	Packaging
ZX62R-B-5P	242-0028-8	2,000 pcs/reel

### ◆ Recommended PCB mounting pattern

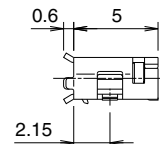
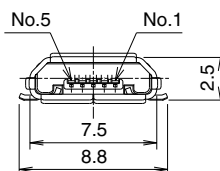
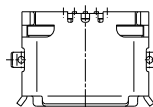
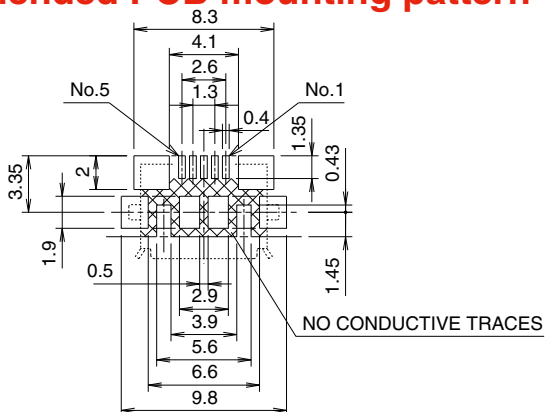

All dimensions: mm

### ● Micro B - Drop-in (Mid-mount), Shell SMT

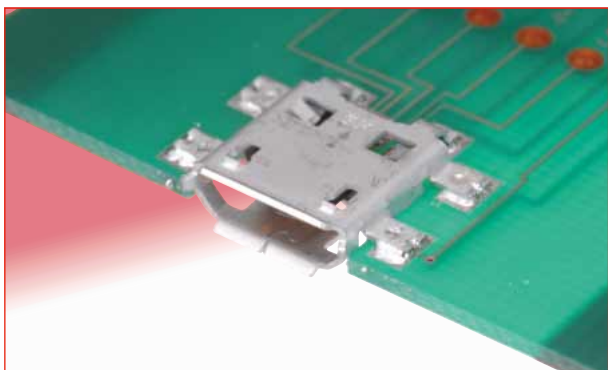

Part No.	HRS No.	Packaging
ZX62M-B-5P(01)	242-0024-7 01	1,500 pcs/reel

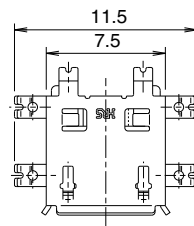

### ◆ Recommended PCB mounting pattern

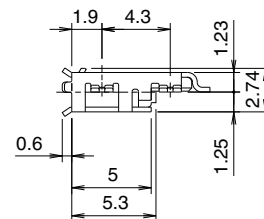
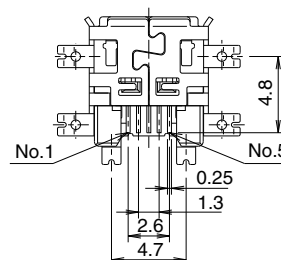
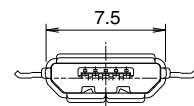
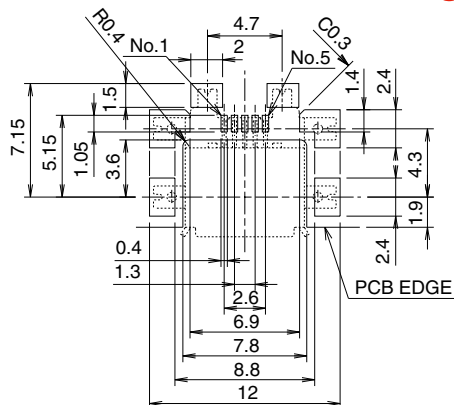

All dimensions: mm

## ■ Receptacles

### ● Micro AB - Standard (Bottom mount), Shell SMT

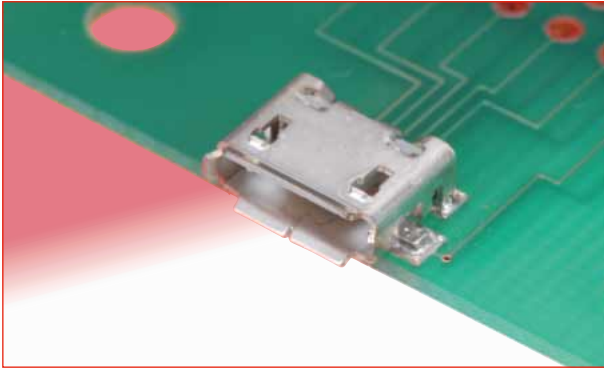

Part No.	HRS No.	Packaging
ZX62-AB-5PA(11)	242-0045-7 11	3,500 pcs/reel

### ◆ Recommended PCB mounting pattern

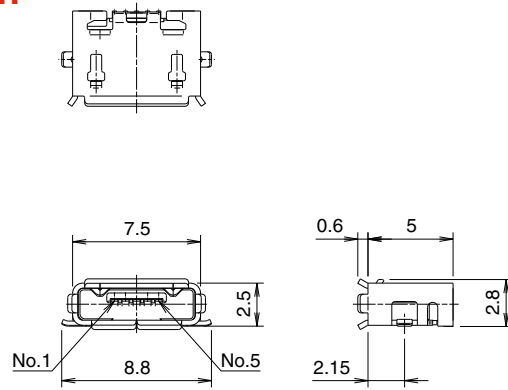

### ● Micro AB - Standard (Bottom mount), Shell through hole

All dimensions: mm

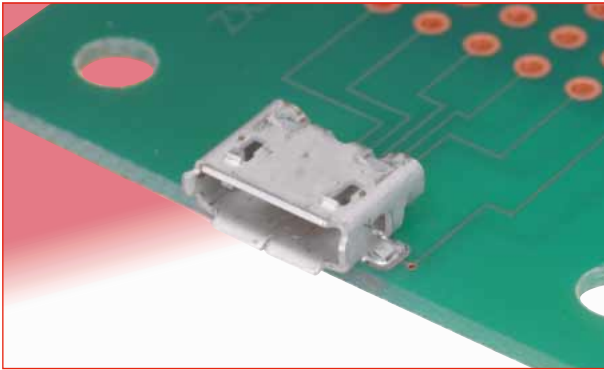





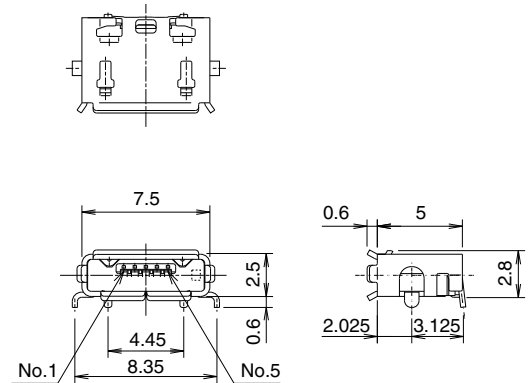
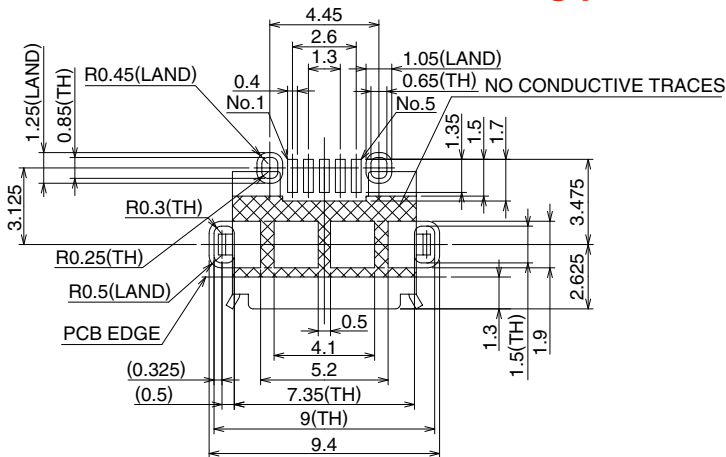

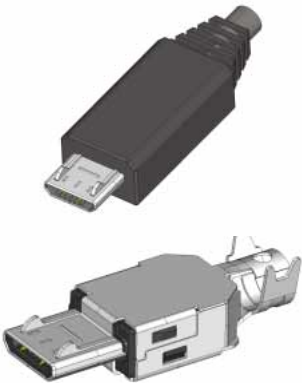
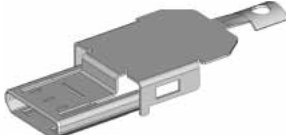

Part No.	HRS No.	Packaging
ZX62D-AB-5P8	242-0027-5	2,000 pcs/reel

### ◆ Recommended PCB mounting pattern

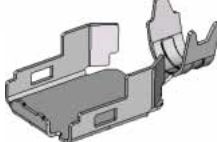

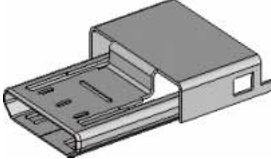
All dimensions: mm

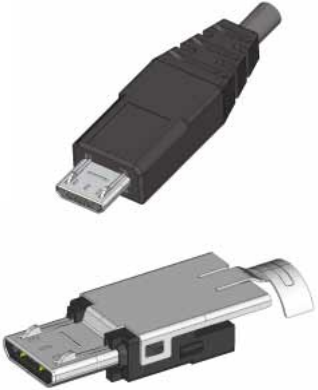
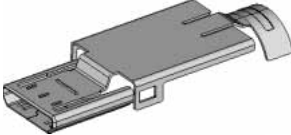

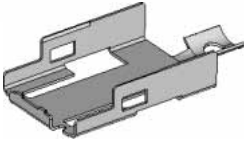
Plugs – assembled (not-terminated, without overmold)	Components
<p data-bbox="240 197 695 230"><b>ZX40 - Direct wire soldering</b></p> 	 <p data-bbox="1177 271 1414 304"><b>ZX40-*SLDA</b></p> <p data-bbox="1177 309 1267 331">Cover-top</p>  <p data-bbox="1177 400 1414 434"><b>ZX40-*5S-UNIT</b></p> <p data-bbox="1177 439 1366 506">Assembly (insulator/ contacts/lock) *No PCB required</p>  <p data-bbox="1177 544 1414 577"><b>ZX40-SLDB</b></p> <p data-bbox="1177 582 1302 604">Cover-bottom</p>
<p data-bbox="240 674 695 707"><b>ZX20 - PCB wire soldering</b></p> 	 <p data-bbox="1177 768 1414 801"><b>ZX20-*SLDC</b></p> <p data-bbox="1177 806 1235 828">Cover</p>  <p data-bbox="1177 916 1414 949"><b>ZX20-*5S-UNIT</b></p> <p data-bbox="1177 954 1414 1043">Assembly (insulator/ contacts/lock) *Vertical through hole PCB termination</p>
<p data-bbox="240 1081 695 1115"><b>ZX64 - PCB wire soldering</b></p> 	 <p data-bbox="1177 1153 1414 1187"><b>ZX64-*SLDA</b></p> <p data-bbox="1177 1191 1267 1214">Cover-top</p>  <p data-bbox="1177 1283 1414 1317"><b>ZX64-*5S-UNIT</b></p> <p data-bbox="1177 1321 1414 1411">Assembly (insulator/ contacts/lock) *Right angle through hole PCB termination</p>  <p data-bbox="1177 1471 1414 1505"><b>ZX64-SLDB</b></p> <p data-bbox="1177 1509 1302 1532">Cover-bottom</p>



## ■ Plugs

### ● Micro B - Assembly (insulator/contacts/lock) – Direct wire soldering



Part No.	HRS No.	Packaging
ZX40-B-5S-UNIT(12)	242-0002-4 12	4,000 pcs/reel

Contact HRS for Cable Termination Procedure Manual.

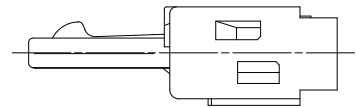
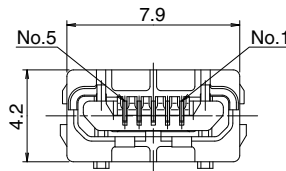
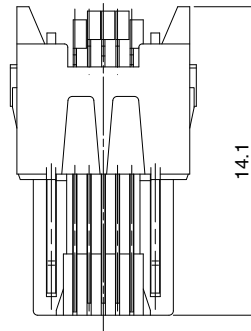
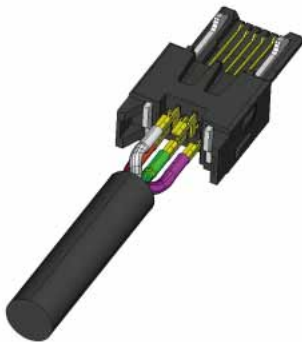

All dimensions: mm

### ● Micro B - Component, Cover-top - Direct wire soldering



Part No.	HRS No.	Packaging
ZX40-B-SLDA	242-0003-7	4,000 pcs/reel

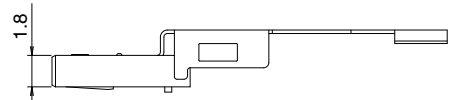
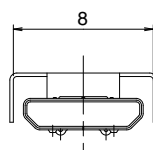
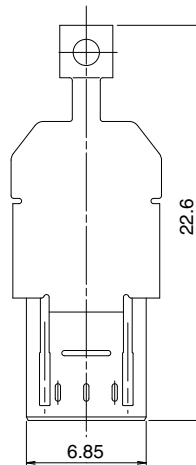

All dimensions: mm

## Plugs

### ● Micro A, Micro B - Component, Cover-bottom - Direct wire soldering

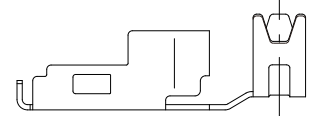
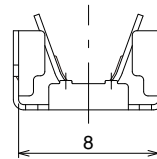
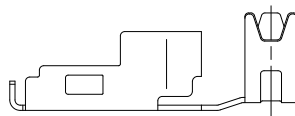
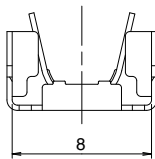
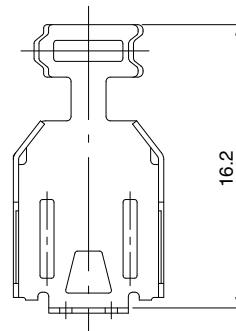
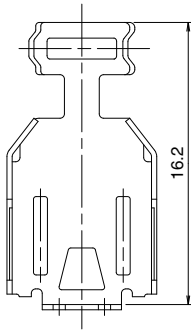
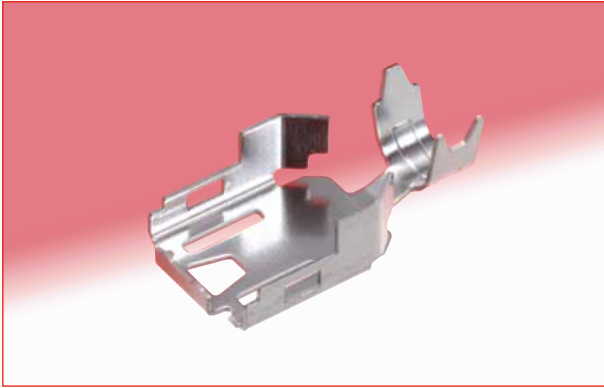

All dimensions: mm

ZX40-SLDB

ZX40-SLDB(3.3)

Part No.	HRS No.	Packaging	Cable dia.
ZX40-SLDB	242-0004-0	4,000 pcs/reel	φ3.8
ZX40-SLDB(3.3)	242-0023-4		φ3.3

### ● Assembled

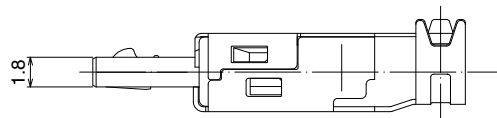
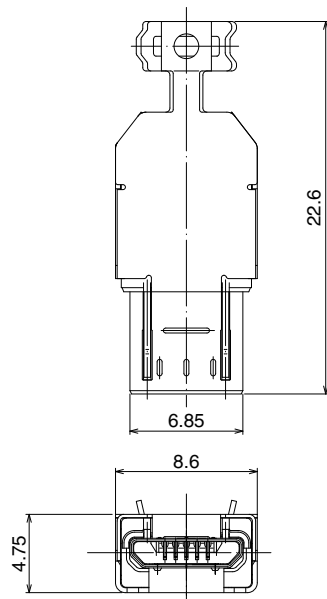

All dimensions: mm

## Plugs

### ● Micro B - Assembly (insulator/contacts/lock) - Vertical through hole PCB wire soldering (non-direct)



Part No.	HRS No.	Packaging
ZX20-B-5S-UNIT	242-0012-8 00	4,000 pcs/pks

Contact HRS for Cable Termination Procedure Manual.

#### PCB mounting pattern

\*PCB required (not supplied)  
Max. thickness: 0.6mm

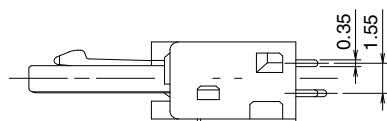
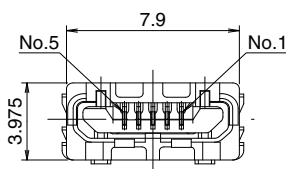
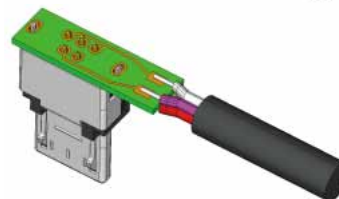
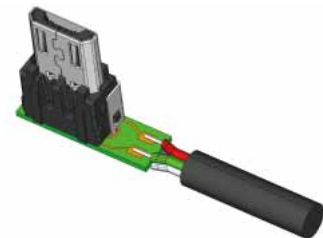
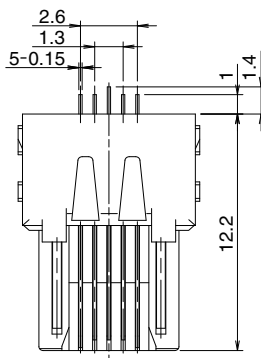
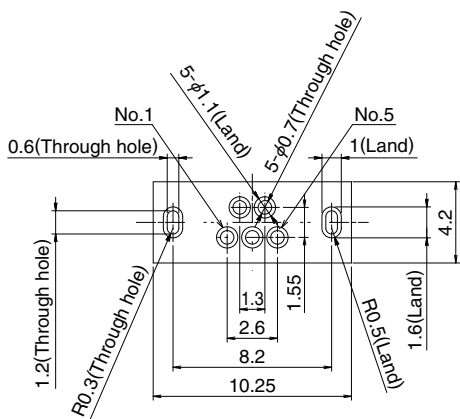

All dimensions: mm

### ● Micro B - Component, Cover - through hole

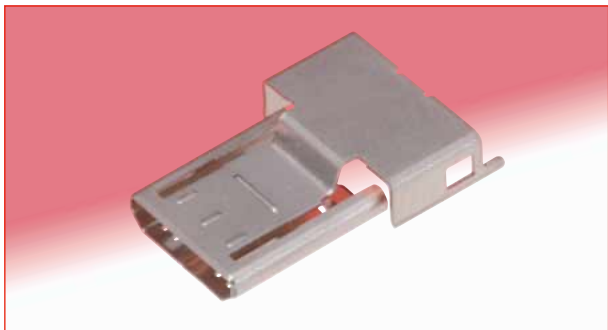

Part No.	HRS No.	Packaging
ZX20-B-SLDC	242-0022-1	4,000 pcs/reel

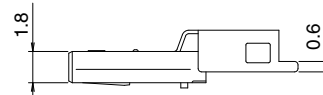
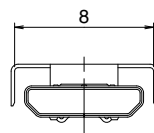
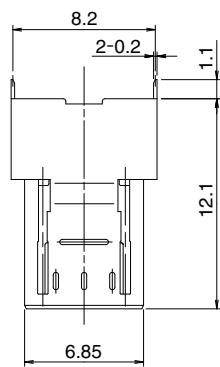

### ● Assembled

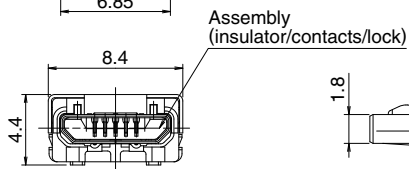
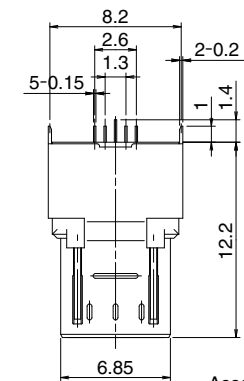

All dimensions: mm

## Plugs

### ● Micro B - Assembly (insulator/contacts/lock) - Right angle SMT

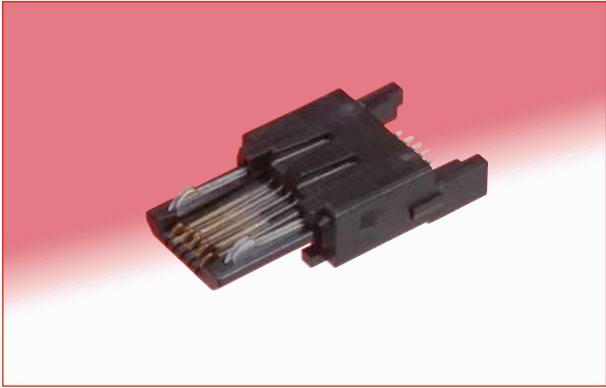

Part No.	HRS No.	Packaging
ZX64-B-5S-UNIT(14)	242-0009-3 14	1 piece

Contact HRS for Cable Termination Procedure Manual.

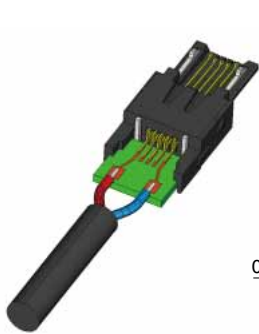

PCB mounting pattern  
\*PCB required (not supplied)  
Max. thickness: 1.0mm

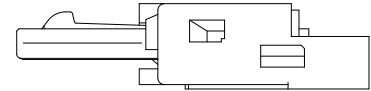
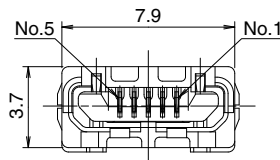
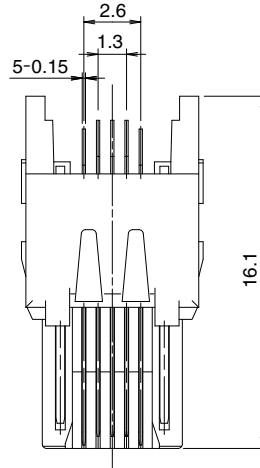
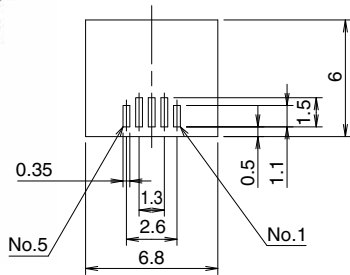

All dimensions: mm

### ● Micro B - Component, Cover-top – Right angle SMT

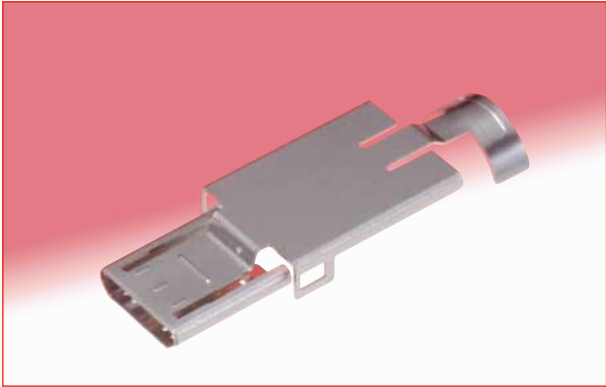

Part No.	HRS No.	Packaging
ZX64-B-SLDA	242-0013-0	4,000 pcs/reel

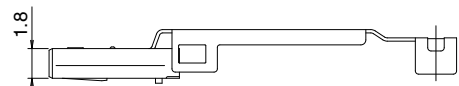
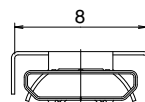
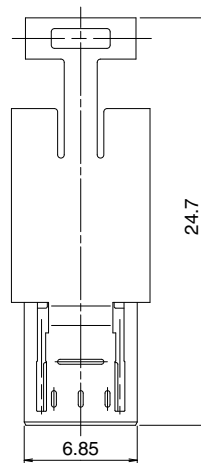

All dimensions: mm

## Plugs

### ● Micro B - Component, Cover-bottom - Right angle SMT

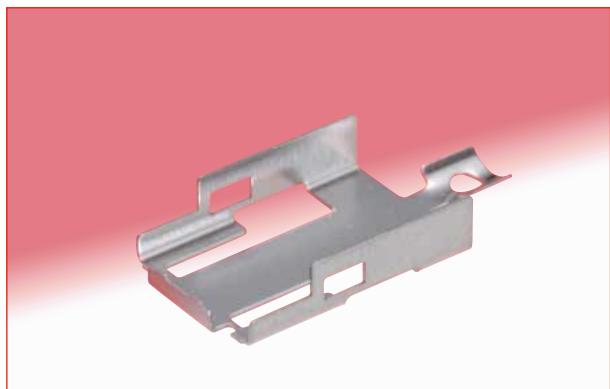

Part No.	HRS No.	Packaging
ZX64-SLDB	242-0049-8	4,000 pcs/reel

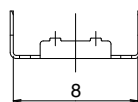
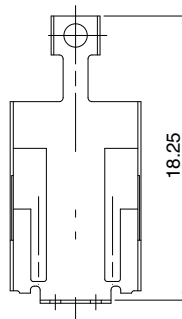

### ● Assembled



All dimensions: mm

### ● Micro B - Component, Shell/cover – Right angle SMT



Part No.	HRS No.	Packaging
ZX64-B-SLDC	242-0018-4	4,000 pcs/reel

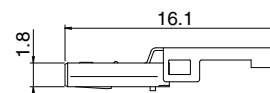
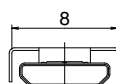
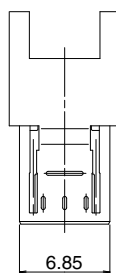

Shell/cover, without cable clamp  
This shell/cover does not require ZX64-SLDB.

### ● Assembled

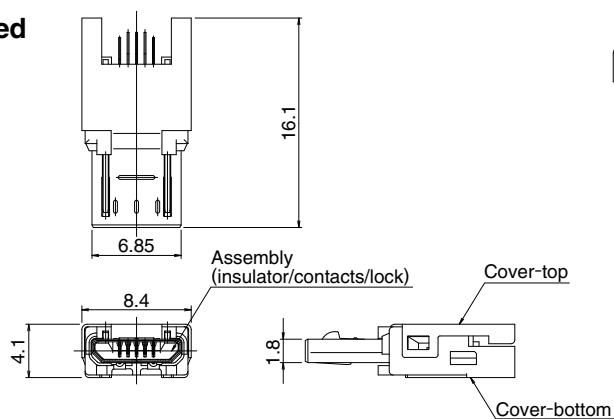

All dimensions: mm

## ■ Plugs

### ● Micro A - Assembly (insulator/contacts/lock) - Direct wire soldering

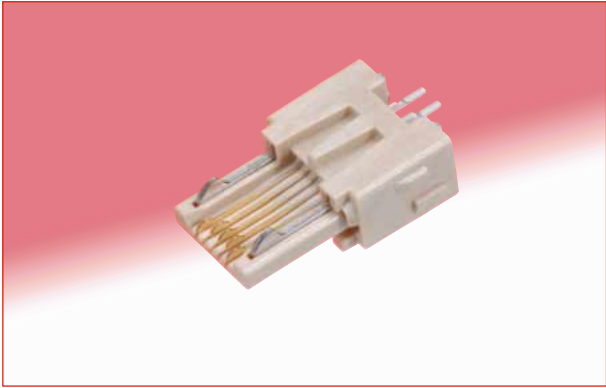

Part No.	HRS No.	Packaging
ZX40-A-5S-UNIT	242-0010-2	1 piece

Contact HRS for Cable Termination Procedure Manual.

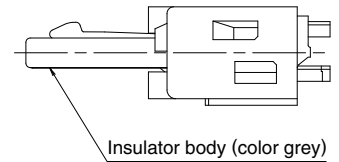
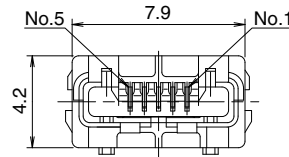
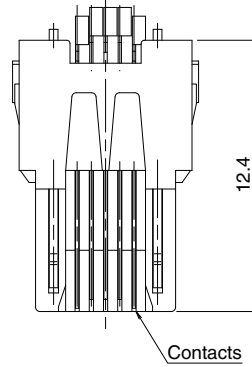

All dimensions: mm

### ● Micro A - Component, Cover-top - Direct wire soldering

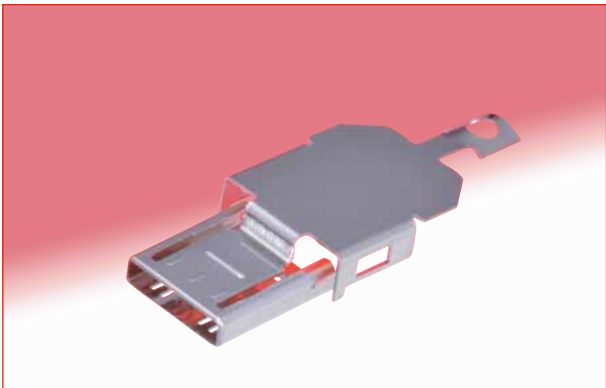

Part No.	HRS No.	Packaging
ZX40-A-SLDA	242-0011-5	4,000 pcs/reel

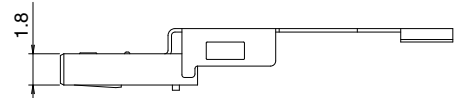
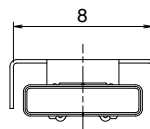
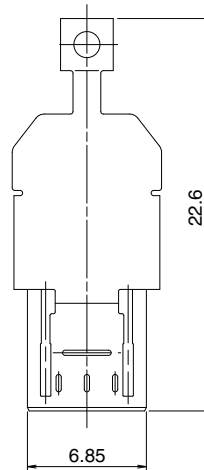

All dimensions: mm

## Plugs

### ● Micro A, Micro B - Component, Cover-bottom - Direct wire soldering

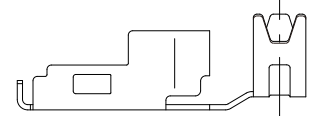
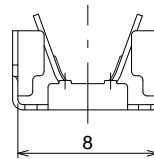
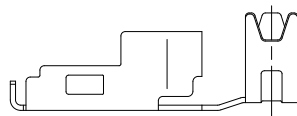
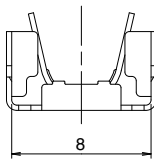
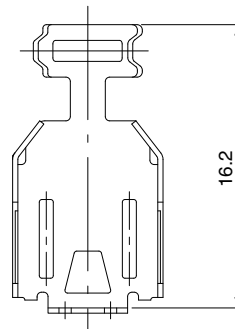
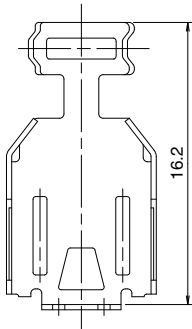
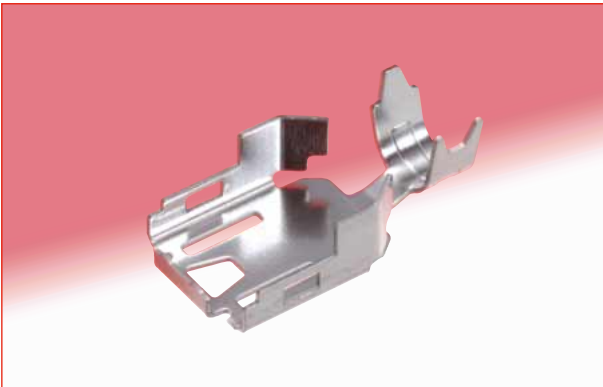

All dimensions: mm

ZX40-SLDB

ZX40-SLDB(3.3)

Part No.	HRS No.	Packaging	Cable dia.
ZX40-SLDB	242-0004-0	4,000 pcs/reel	φ3.8
ZX40-SLDB(3.3)	242-0023-4		φ3.3

### ● Assembled

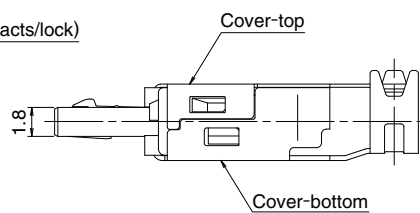
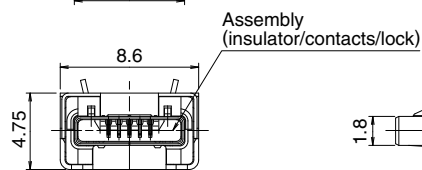
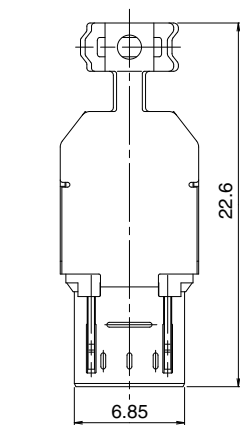

All dimensions: mm

## ■ Plug-Vertical, cradle mount, Shell through hole

### ● Micro B, with lock

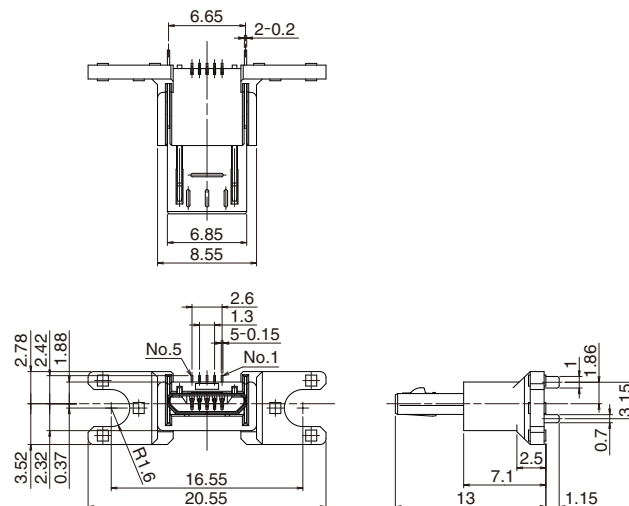
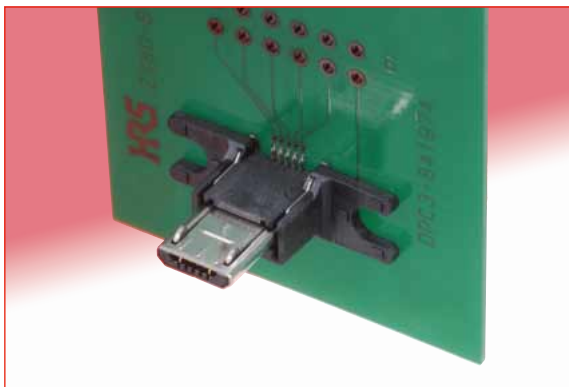

Part No.	HRS No.	Packaging
ZX80-B-5S	242-0017-1	100 pcs/pks

All dimensions: mm

### ● Micro B, without lock

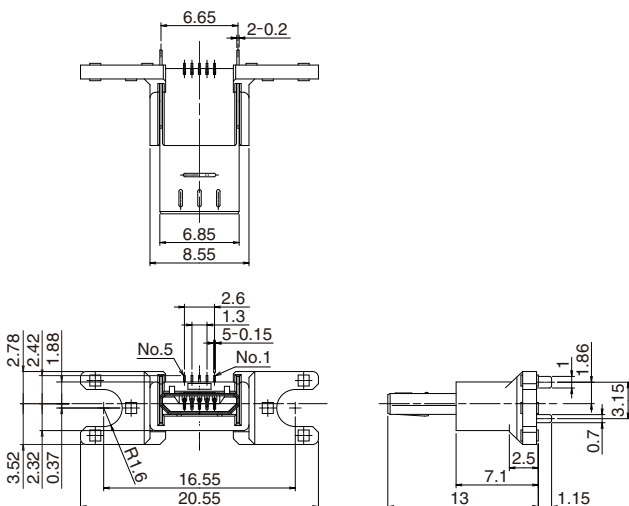

Part No.	HRS No.	Packaging
ZX80-B-5SA	242-0019-7	100 pcs/pks

## ◆ PCB mounting pattern

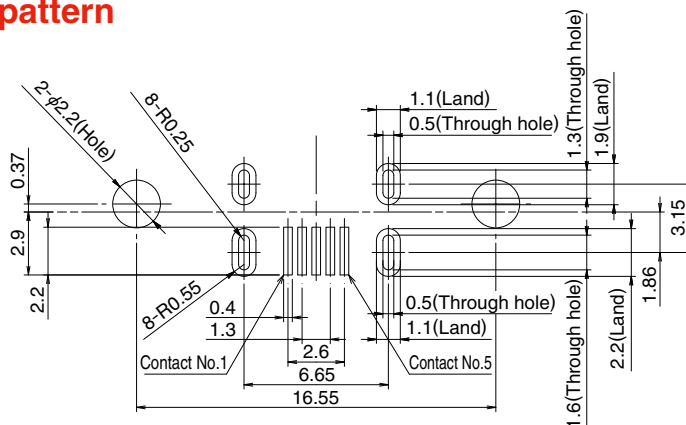

All dimensions: mm



## ◆ Packaging Specifications

### ● Embossed carrier tape dimensions

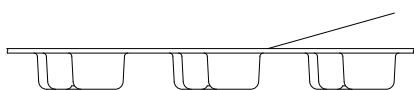

Part No.	A dimension	B dimension
ZX62-B-5PA(11)	24	11.5
ZX62-AB-5PA(11)	24	11.5
ZX62M-B-5P(01)	24	11.5
Other	16	7.5

### ● Reel Dimensions

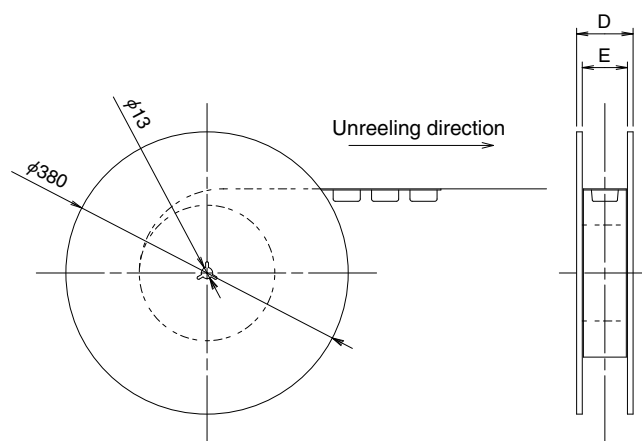

Part No.	D dimension	E dimension
ZX62-B-5PA(11)	30.4	24.4
ZX62-AB-5PA(11)	30.4	24.4
ZX62M-B-5P(01)	30.4	24.4
Other	22.4	16.4

## ◆ Recommended Temperature Profile - Receptacles

### ● Using lead-free solder paste

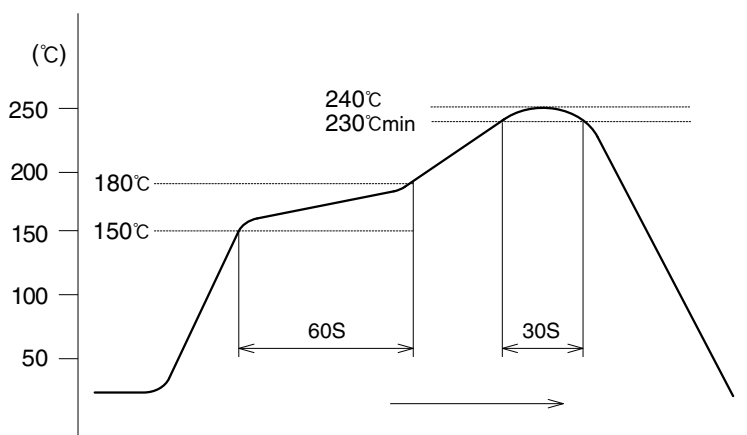

The temperature profile is based on the left conditions.

In individual applications the actual temperature may vary, depending on solder paste type, volume/thickness and board size/thickness. Contact your solder paste and equipment manufacturer for specific recommendations.

Note 1: Up to 2 cycles of Reflow soldering are possible under the same conditions, provided that there is a return to normal temperature between the first and second cycle.

Note 2: The temperature profile indicates the board surface temperature at the point of contacts with the connector terminals.

## ◆ Precautions

1. Exercise care when handling the connectors. Do not subject them to excessive external forces when mating/un-mating.
2. Mate and un-mate as intended, holding by the overmolded body, in the correct direction. Do not un-mate by pulling on the cable.
3. Some tooling marks may be visible on the surfaces of receptacle (shell/cover). No form/fit or function is affected.
4. Appearance of the surface finishes on the receptacles may vary between production runs. No affect on form, fit or function.

## MEMO :

A series of horizontal dashed lines for writing notes.



**USA:**

**HIROSE ELECTRIC (U.S.A.), INC. Headquarters**  
2688 Westhills Court, Simi Valley, CA 93065-6235  
Phone : +1-805-522-7958  
Fax : +1-805-522-3217  
<http://www.hiroseusa.com>

**USA:**

**HIROSE ELECTRIC (U.S.A.), INC. San Jose Office**  
3255 Scott Boulevard, Building 7, Suite 101  
Santa Clara, CA 95054  
Phone : +1-408-253-9640  
Fax : +1-408-253-9641  
<http://www.hiroseusa.com>

**USA:**

**HIROSE ELECTRIC (U.S.A.), INC. Detroit Office (Automotive)**  
37677 Professional Center Drive, Suite #100C  
Livonia, MI 48154  
Phone : +1-734-542-9963  
Fax : +1-734-542-9964  
<http://www.hiroseusa.com>

**THE NETHERLANDS:**

**HIROSE ELECTRIC EUROPE B.V.**  
Hogehillweg #8 1101 CC Amsterdam Z-O  
Phone : +31-20-6557460  
Fax : +31-20-6557469  
<http://www.hiroseeurope.com>

**GERMANY:**

**HIROSE ELECTRIC EUROPE B.V. German Branch**  
Herzog-Carl-Strasse 4 D-73760 Ostfildern  
(Scharnhauser Park)  
Phone : +49-711-4560-02-1  
Fax : +49-711-4560-02-299  
<http://www.hirose.de>

**GERMANY:**

**HIROSE ELECTRIC EUROPE B.V. Nuernberg Office**  
Muggenhofer Str. 136 90429 Nuernberg  
Phone : +49-911 32 68 89 63  
Fax : +49-911 32 68 89 69  
<http://www.hirose.de>

**UNITED KINGDOM:**

**Hirose Electric Europe BV (UK Branch)**  
4 Newton Court, Kelvin Drive, Knowlhill,  
Milton Keynes, MK5 8NH  
Phone : +44-1908 202050  
Fax : +44-1908 202058

**CHINA:**

**HIROSE ELECTRIC (SHANGHAI) CO., LTD.**  
1601, Henderson Metropolitan, NO.300, East Nanjing  
Road, Huangpu District, Shanghai, China 200001  
Phone : +86-21-6391-3355  
Fax : +86-21-6391-3335  
<http://www.hirose-china.com.cn>

**CHINA:**

**HIROSE ELECTRIC (SHANGHAI) CO.,LTD. BEIJING BRANCH**  
A1001, Ocean International Center, Building 56# East 4th  
Ring Middle Road, ChaoYang District, Beijing, 100025  
Phone : +86-10-5165-9332  
Fax : +86-10-5908-1381  
<http://www.hirose-china.com.cn>

**CHINA:**

**HIROSE ELECTRIC TECHNOLOGIES (SHENZHEN) CO., LTD.**  
Room 09-13, 19/F, Office Tower Shun Hing Square, Di Wang Commercial Centre,  
5002 Shen Nan Dong Road, Shenzhen City, Guangdong Province, 518008  
Phone : +86-755-8207-0851  
Fax : +86-755-8207-0873  
<http://www.hirose-china.com.cn>

**HONG KONG:**

**HIROSE ELECTRIC HONGKONG TRADING CO., LTD.**  
Room 1001, West Wing, Tsim Sha Tsui Centre, 66  
Mody Road, Tsim Sha Tsui East, Kowloon, Hong Kong  
Phone : +852-2803-5338  
Fax : +852-2591-6560  
<http://www.hirose-hongkong.com.hk>

**TAIWAN:**

**HIROSE ELECTRIC TAIWAN CO., LTD.**  
103 8F, No.87, Zhengzhou Rd., Taipei  
Phone : +886-2-2555-7377  
Fax : +886-2-2555-7350  
<http://www.hirose-taiwan.com.tw>

**KOREA:**

**HIROSE KOREA CO., LTD.**  
1261-10, Jeoungwhang-Dong, Shihung-City,  
Kyunggi-Do 429-450  
Phone : +82-31-496-7000,7124  
Fax : +82-31-496-7100  
<http://www.hirose.co.kr>

**SINGAPORE:**

**HIROSE ELECTRIC SINGAPORE PTE. LTD.**  
10 Anson Road #26-1, International Plaza  
079903, Singapore  
Phone : +65-6324-6113  
Fax : +65-6324-6123  
<http://www.hirose-singapore.com.sg>

**INDIA:**

**HIROSE ELECTRIC SINGAPORE PTE. LTD Delhi Liaison Office**  
Suite No. 606 5th Floor SB Tower 1A/1 Sector  
16 A Filmcity Noida 201301 Uttar Pradesh-India  
Phone : +91-120-4804917  
Fax : +91-120-4804949  
<http://www.hirose.com/sg/>

**INDIA:**

**HIROSE ELECTRIC SINGAPORE PTE. LTD. Bangalore Liaison office**  
Unit No.03, Ground Floor, Explorer Building International Tech  
Park Whitefield Road, Bangalore 560066 Karnataka, India  
Phone : +91-80-4120 1907  
Fax : +91-80-4120 9908  
<http://www.hirose-singapore.com.sg>

**MALAYSIA:**

**HIROSE ELECTRIC SINGAPORE PTE. LTD (Representative office)**  
1-10-07, Suntech @ Penang Cybercity (1164),Lintang  
Mayang Pasir 3,11950, Bayan Baru, Penang, Malaysia.  
Phone : +604-619-2564  
Fax : +604-619-2574  
<http://www.hirose.com/sg/>



**HIROSE ELECTRIC CO.,LTD.**

2-6-3,Nakagawa Chuoh,Tsuzuki-Ku,Yokohama-Shi 224-8540,JAPAN  
TEL: +81-45-620-3526 Fax: +81-45-591-3726  
<http://www.hirose.com>  
<http://www.hirose-connectors.com>