

Micro-USB connectors meeting USB 2.0 Standard

ZX Series

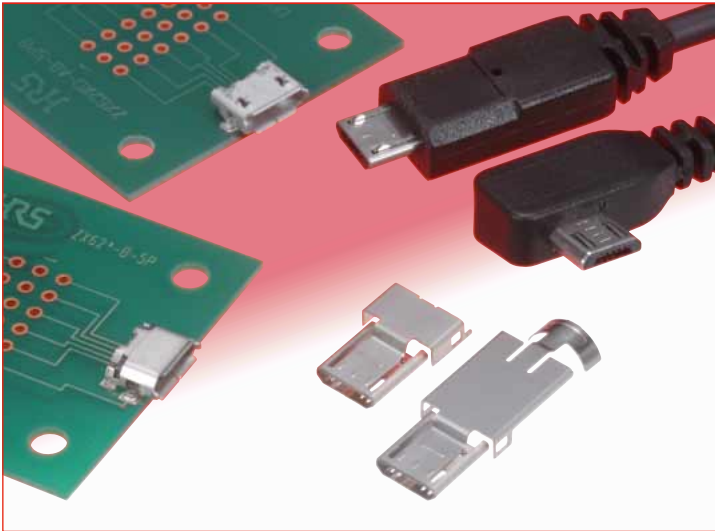

Note: Contact us to ascertain whether a TID number has been acquired for an individual product.

Fig.1

Overview

Extremely small highly reliable connectors complying with physical, electrical and environmental requirements of Micro-USB standard (USB 2.0). Receptacles and plugs are available in a wide variety of mounting and termination styles, allowing their use in various applications.

Features

1. Size reduction

Compared with the standard Mini-USB connectors, the size of ZX connectors is reduced by approximately 60% while still allowing a high-speed data transfer of 480 Mbps, specified in USB 2.0.

2. Receptacle styles

Two interface configurations: Micro-B and Micro-AB in standard, mid-mount and reverse mounting styles. SMT and through-hole (shell) PC board terminations.

3. Plug styles

Corresponding to the receptacle styles, two interface configurations: Micro-A and Micro-B, with direct wire or PCB wire soldering. Several plug styles can be used for data transmission, earphone or charging applications.

4. Smooth mating and unmating

A smooth mating and unmating operation results in less wear and a longer product life. The unique Hirose active latch mechanism produces a reliable and durable connector.

Even after repeated use, the user will experience a smooth click sensation when mating the connectors. Note: The statement above only applies when using both plug and receptacles made by Hirose Electric.

5. Hirose was the first company to obtain a Micro-USB certification (TID number).

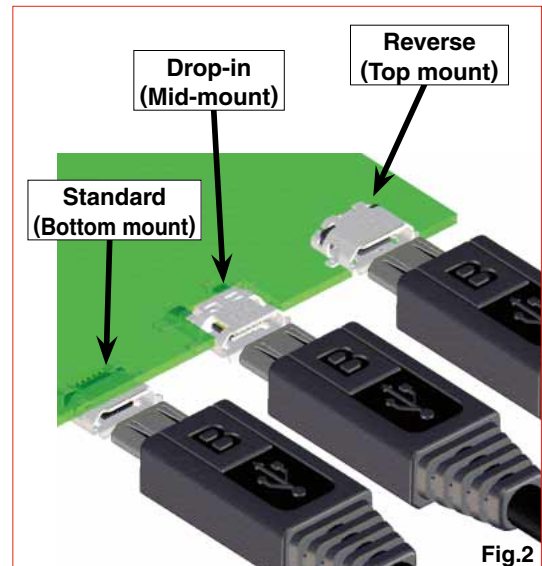

Fig.2

USB 2.0 Hi-Speed (480 Mbps)

Eye diagram measurement results:
Measured with 2.4 m long USB 2.0 cable

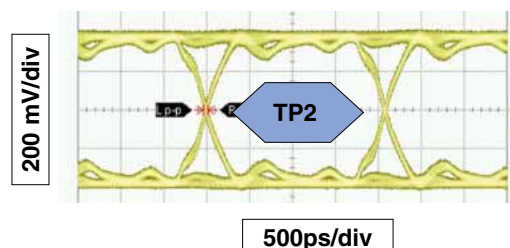

Fig.3

■ Specifications

Ratings	Current rating	1 A (per contact) or 1.8 A (contacts No. 1 and 5) and 0.5 A (contacts No. 2, 3, and 4)	Voltage rating	30 V AC
			Operating temperature range	-30°C to +85 °C (Note1)
			Storage temperature range	-30 °C to +60°C

Item	Specification	Conditions
1. Contact resistance	30 mΩ max.	100 mA
2. Withstanding voltage	No flashover or insulation breakdown	100 V AC / 1 minute
3. Capacitance	2 pF max.	Between adjacent contacts at 1,000 Hz (AC voltage)
4. Durability	Contact resistance: Rise from initial value of 10 mΩ max.	10,000 cycles
5. Total insertion/removal force	Insertion force: 35 N max., Removal force: 8 N min.	Mated with corresponding connector

Note1: Includes temperature rise caused by current flow.

Note2: Information contained in this catalog represents general requirements for this Series. Contact us for the drawings and specifications for a specific part number shown.

■ Materials

● Receptacles

Part	Material	Finish	Remarks
Insulator	LCP	Micro-B: Black, Micro-AB: Gray	UL94V-0
Contacts	Copper alloy	Selective gold plated	————
Shell	Stainless steel	Tin alloy plating	————

● Plugs

Part	Material	Finish	Remarks
Insulator	LCP	Micro-B: Black, Micro-AB: Gray	UL94V-0
Contacts	Copper alloy	Selective gold plated	————
Shell	Stainless steel	Tin alloy plating	————

■ Ordering information

● Receptacles

ZX 62 RD - B - 5 P * 8
1 2 3 4 5 6 7 8

● Plugs

ZX 40 - B - 5 S * - UNIT
1 2 4 5 6 7 9

ZX 40 - B - SLDA
1 2 4 9

1 Series name	ZX
2 Termination style	10's: Right-angle PCB wire, SMT 20's: Straight, PCB wire 40's: Direct wire 60's: Right-angle, PCB wire 80's: Cradle SMT
3 Board mounting style (Receptacles)	Blank Standard (Bottom mount) D Standard (Bottom mount) through hole R Reverse (Top mount) RD Reverse (Top mount) through hole M Drop-in (Mid-mount)
4 Mating side configuration	A Micro-A B Micro-B AB Micro-AB
5 Number of contacts	5
6 Contact type	P Receptacle- Male S Plug – Female
7 Serial No.	
8 Shell termination style – Blank Receptacles	SMT 8 Through hole (solder tab length: 0.8mm)
9 Components-plugs	UNIT Assembly (Insulator/contact/lock) Cover (Note 1)

Note 1: Classifiers such as A, B, and C are entered for *.

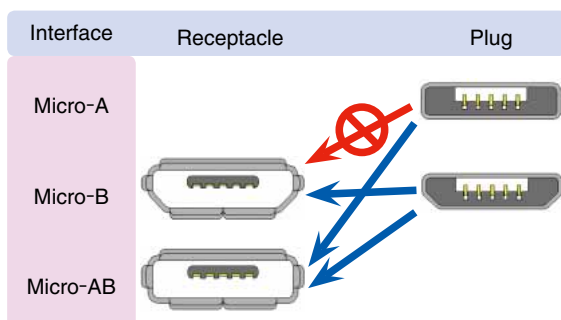

■ Configurations

	Mating side configuration	Type	Part No.	3D Image	Page	
R e c e p t a c l e s	Micro-B	Standard	SMT	ZX62-B-5PA(11)		4
			SMT + DIP	ZX62D-B-5PA8		4
		Reverse	SMT	ZX62R-B-5P		5
		Drop-in	SMT	ZX62M-B-5P(01)		5
	Micro-AB	Standard	SMT	ZX62-AB-5PA(11)		6
			SMT + DIP	ZX62D-AB-5P8		6
		Reverse	SMT	ZX62R-AB-5P		7
			SMT + DIP	ZX62RD-AB-5P8		7
P l u g s	Micro-B	Direct wire soldering	Assembly (insulator/contacts/lock) :ZX40-B-5S-UNIT(12) Cover-top :ZX40-B-SLDA Cover-bottom :ZX40-SLDB		9 and 10	
		PCB wire soldering (straight, through hole)	Assembly (insulator/contacts/lock) :ZX20-B-5S-UNIT Cover :ZX20-B-SLDC		11	
		PCB wire soldering (SMT)	Assembly (insulator/contacts/lock) :ZX64-B-5S-UNIT(14) Cover-top :ZX64-B-SLDA Cover-bottom :ZX64-SLDB		12 and 13	
		PCB wire soldering (SMT)	Assembly (insulator/contacts/lock) :ZX64-B-5S-UNIT(14) Cover :ZX64-B-SLDC		12 and 14	
	Micro-A	Direct wire soldering	Assembly (insulator/contacts/lock) :ZX40-A-5S-UNIT Cover-top :ZX40-A-SLDA Cover-bottom :ZX40-SLDB		15 and 16	
C r a d l e s	Micro-B	SMT + DIP	ZX80-B-5S	With lock	17	
			ZX80-B-5SA	Without lock	17	

Note: 1. Part numbers in the Plugs section of the above table list the Assembly (insulator/contacts/locks) and the corresponding Shields/Covers.

Note: 2. Optional Printed Circuit boards for the Plugs are shown for reference only. Not supplied with applicable connectors.

Note: 3. The color of the insulators body in the Assembly (insulator/contacts/lock) shown in the 3D Image column above is blue for clarity. Refer to the Materials (Page 2) for correct colors.

■ Receptacles

● Micro B - Standard (Bottom mount), Shell SMT

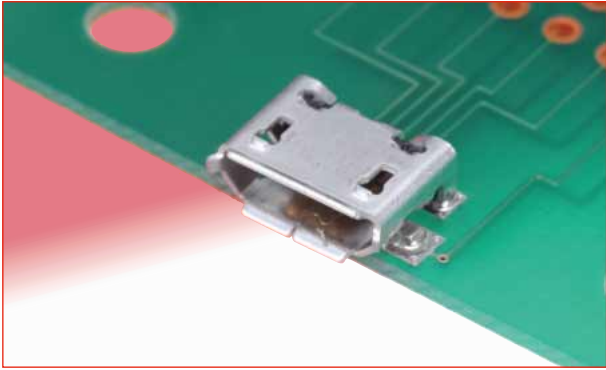

Part No.	HRS No.	Packaging
ZX62-B-5PA(11)	242-0033-8 11	3,500 pcs/reel

◆ Recommended PCB mounting pattern



All dimensions: mm

● Micro B - Standard (Bottom mount), Shell through hole

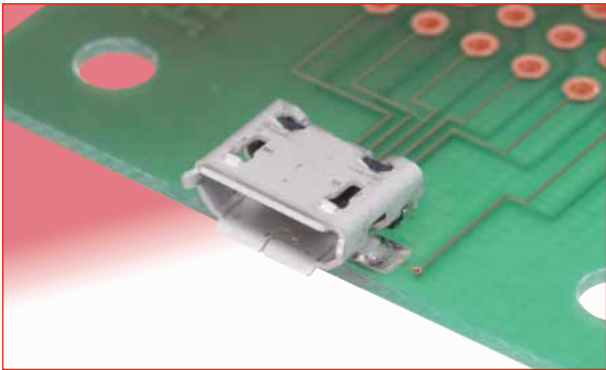

Part No.	HRS No.	Packaging
ZX62D-B-5PA8	242-0056-3	2,000 pcs/reel

◆ Recommended PCB mounting pattern

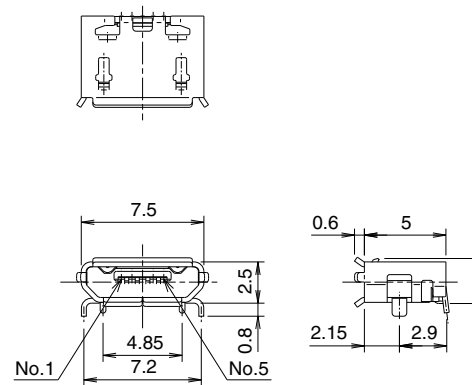
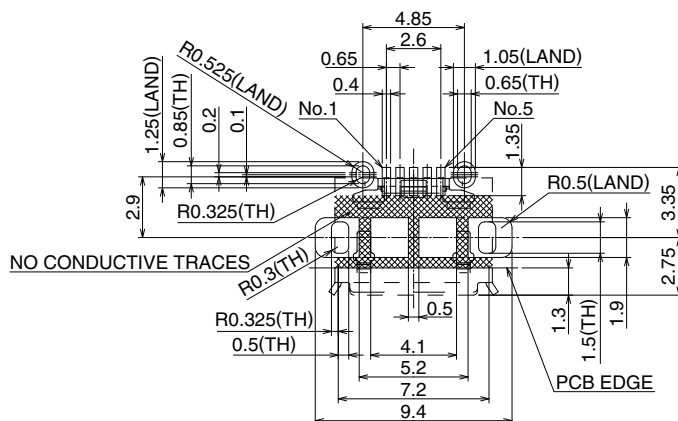

All dimensions: mm

■ Receptacles

● Micro B - Reverse (Top mount) Shell SMT

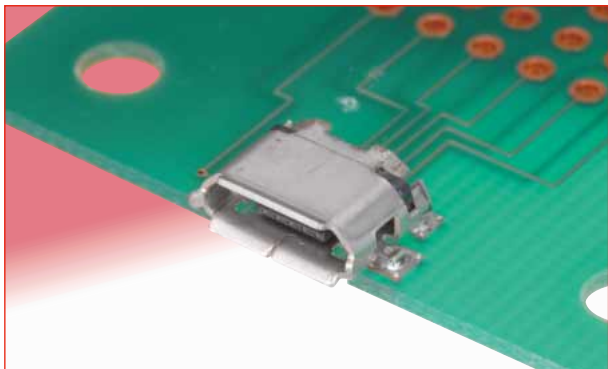

Part No.	HRS No.	Packaging
ZX62R-B-5P	242-0028-8	2,000 pcs/reel

◆ Recommended PCB mounting pattern

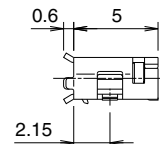
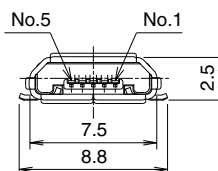
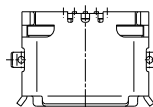
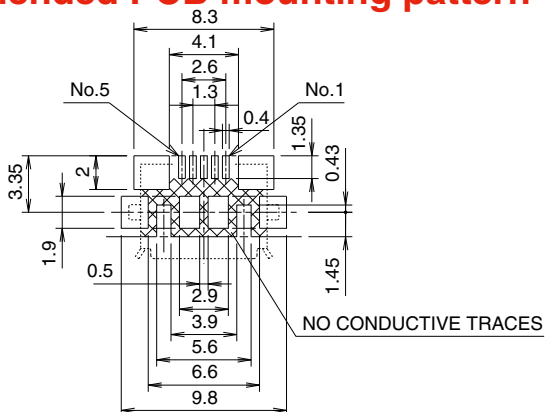

All dimensions: mm

● Micro B - Drop-in (Mid-mount), Shell SMT

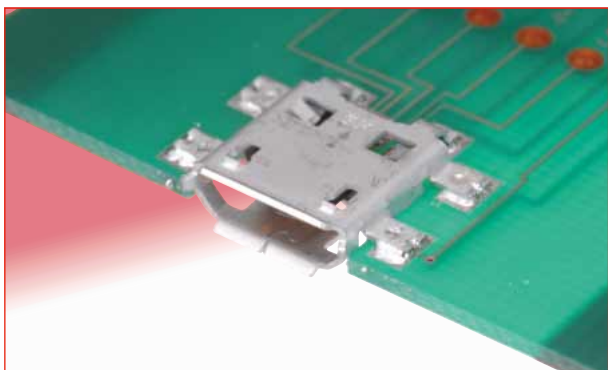

Part No.	HRS No.	Packaging
ZX62M-B-5P(01)	242-0024-7 01	1,500 pcs/reel

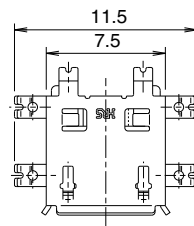

◆ Recommended PCB mounting pattern

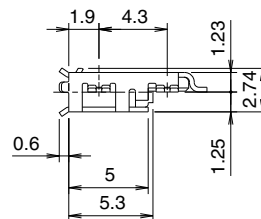
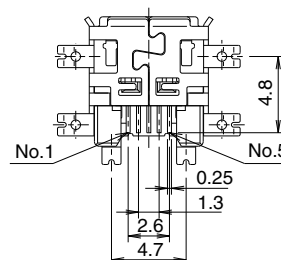
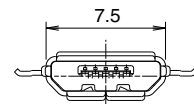
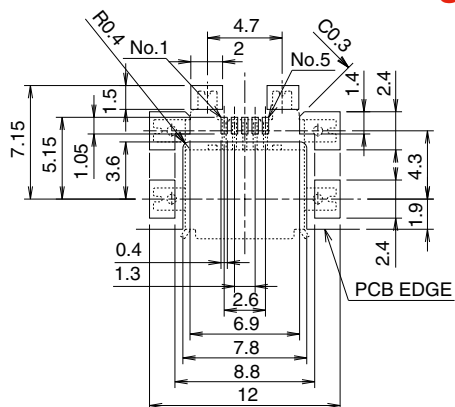

All dimensions: mm

■ Receptacles

● Micro AB - Standard (Bottom mount), Shell SMT

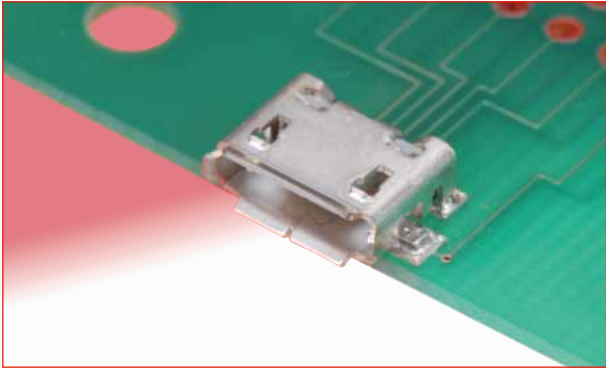

Part No.	HRS No.	Packaging
ZX62-AB-5PA(11)	242-0045-7 11	3,500 pcs/reel

◆ Recommended PCB mounting pattern

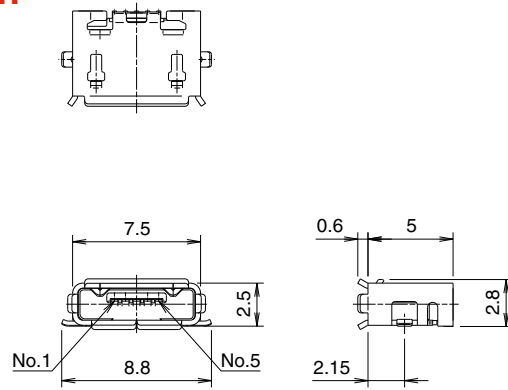

● Micro AB - Standard (Bottom mount), Shell through hole

All dimensions: mm

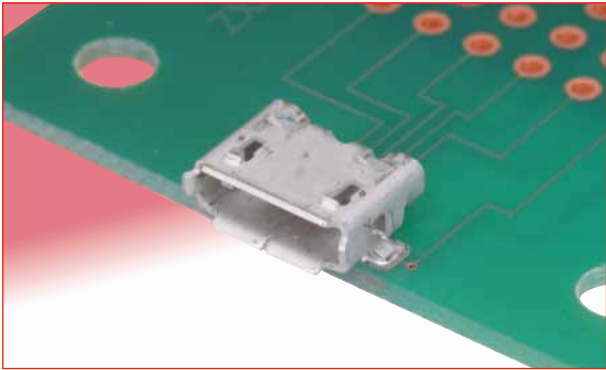





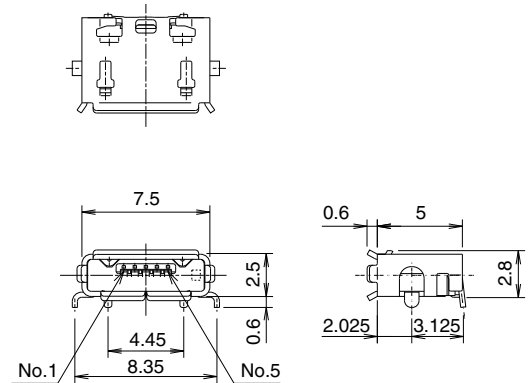
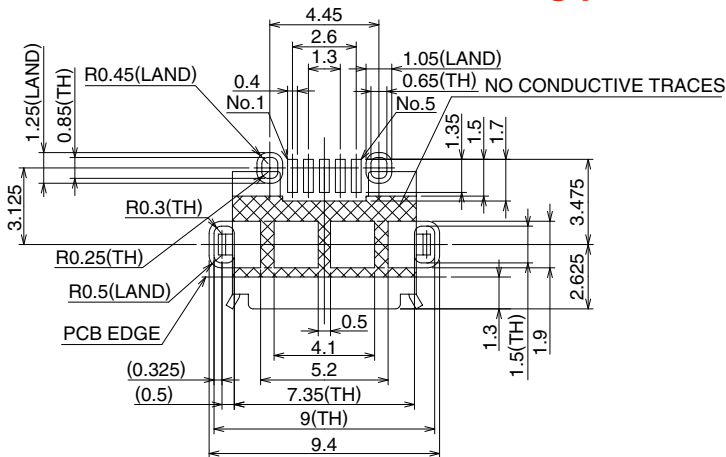

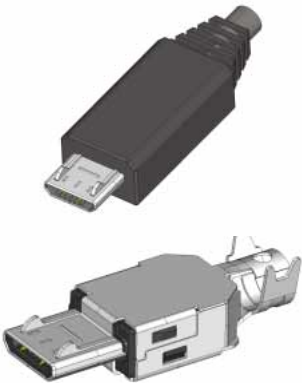
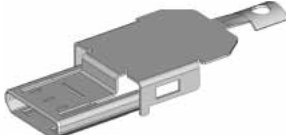

Part No.	HRS No.	Packaging
ZX62D-AB-5P8	242-0027-5	2,000 pcs/reel

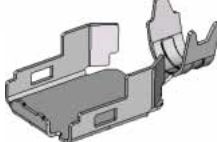
◆ Recommended PCB mounting pattern

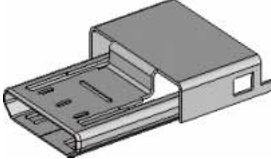

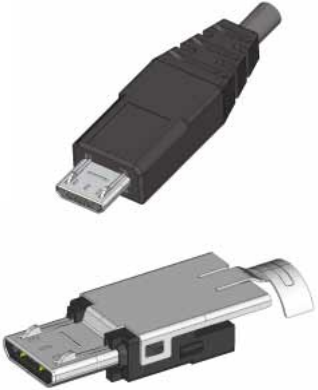
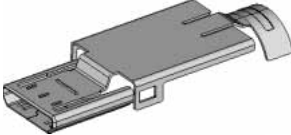
All dimensions: mm

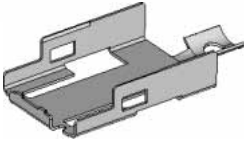
Plugs – assembled (not-terminated, without overmold)	Components
<p data-bbox="240 197 695 230">ZX40 - Direct wire soldering</p> 	 <p data-bbox="1177 271 1414 304">ZX40-*SLDA</p> <p data-bbox="1177 309 1267 331">Cover-top</p>  <p data-bbox="1177 400 1414 434">ZX40-*5S-UNIT</p> <p data-bbox="1177 439 1366 506">Assembly (insulator/ contacts/lock) *No PCB required</p>  <p data-bbox="1177 544 1414 577">ZX40-SLDB</p> <p data-bbox="1177 582 1302 604">Cover-bottom</p>
<p data-bbox="240 674 695 707">ZX20 - PCB wire soldering</p> 	 <p data-bbox="1177 768 1414 801">ZX20-*SLDC</p> <p data-bbox="1177 806 1235 828">Cover</p>  <p data-bbox="1177 916 1414 949">ZX20-*5S-UNIT</p> <p data-bbox="1177 954 1414 1043">Assembly (insulator/ contacts/lock) *Vertical through hole PCB termination</p>
<p data-bbox="240 1081 695 1115">ZX64 - PCB wire soldering</p> 	 <p data-bbox="1177 1153 1414 1187">ZX64-*SLDA</p> <p data-bbox="1177 1191 1267 1214">Cover-top</p>  <p data-bbox="1177 1283 1414 1317">ZX64-*5S-UNIT</p> <p data-bbox="1177 1321 1414 1411">Assembly (insulator/ contacts/lock) *Right angle through hole PCB termination</p>  <p data-bbox="1177 1471 1414 1505">ZX64-SLDB</p> <p data-bbox="1177 1509 1302 1532">Cover-bottom</p>

Plugs

● Micro B - Assembly (insulator/contacts/lock) – Direct wire soldering

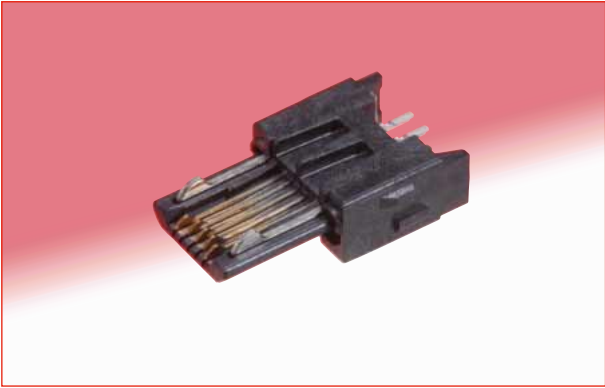

Part No.	HRS No.	Packaging
ZX40-B-5S-UNIT(12)	242-0002-4 12	4,000 pcs/reel

Contact HRS for Cable Termination Procedure Manual.

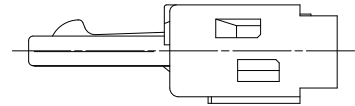
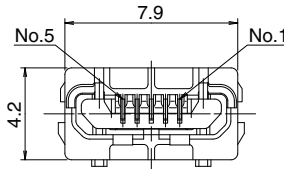
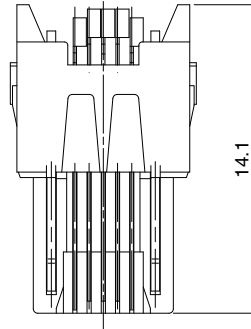
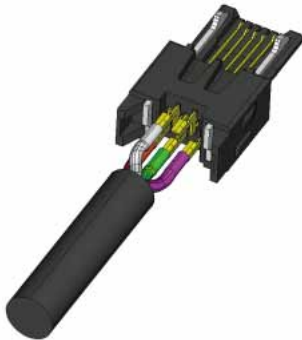

All dimensions: mm

● Micro B - Component, Cover-top - Direct wire soldering



Part No.	HRS No.	Packaging
ZX40-B-SLDA	242-0003-7	4,000 pcs/reel

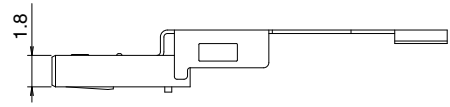
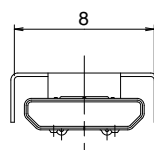
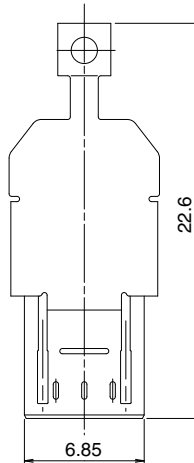

All dimensions: mm

■ Plugs

● Micro A, Micro B - Component, Cover-bottom - Direct wire soldering

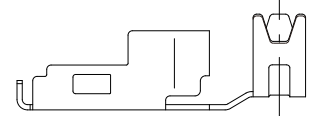
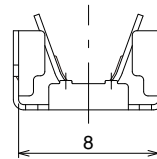
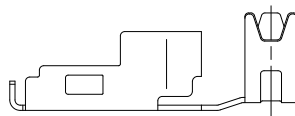
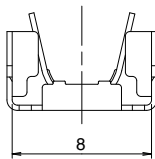
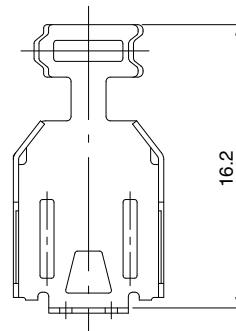
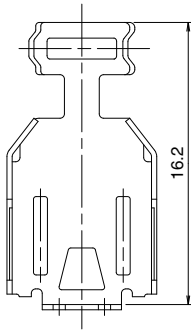
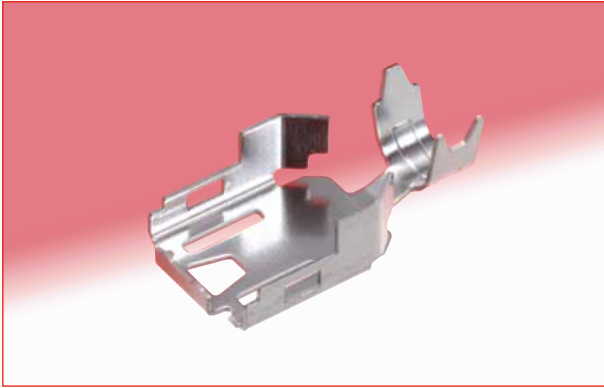

All dimensions: mm

ZX40-SLDB

ZX40-SLDB(3.3)

Part No.	HRS No.	Packaging	Cable dia.
ZX40-SLDB	242-0004-0	4,000 pcs/reel	φ3.8
ZX40-SLDB(3.3)	242-0023-4		φ3.3

● Assembled

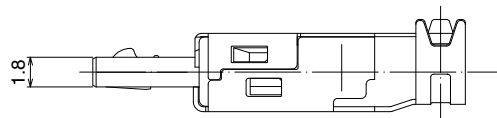
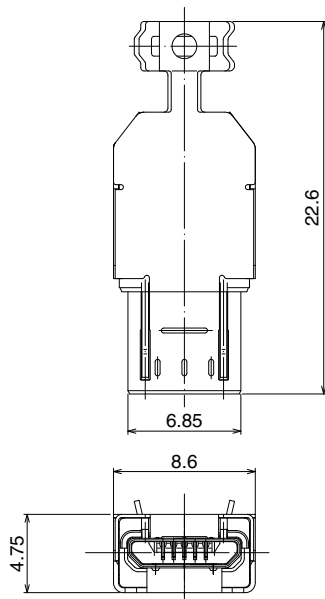

All dimensions: mm

Plugs

● Micro B - Assembly (insulator/contacts/lock) - Vertical through hole PCB wire soldering (non-direct)



Part No.	HRS No.	Packaging
ZX20-B-5S-UNIT	242-0012-8 00	4,000 pcs/pks

Contact HRS for Cable Termination Procedure Manual.

PCB mounting pattern

*PCB required (not supplied)
Max. thickness: 0.6mm

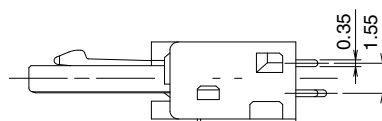
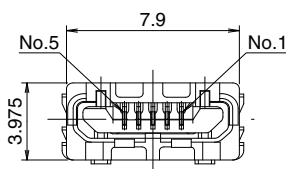
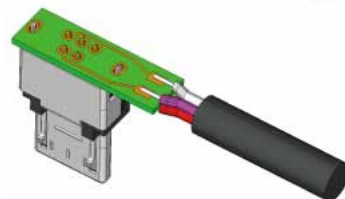
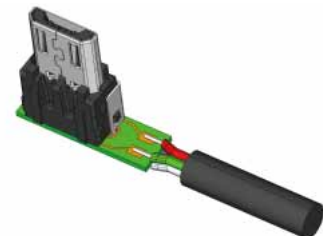
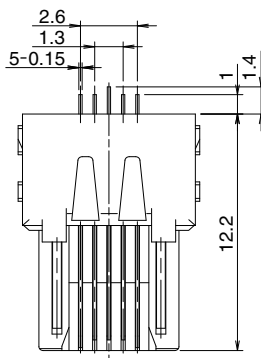
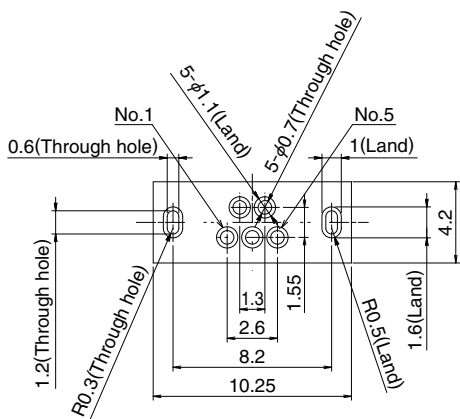

All dimensions: mm

● Micro B - Component, Cover - through hole

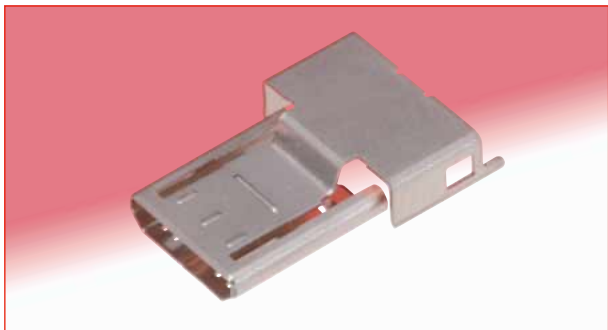

Part No.	HRS No.	Packaging
ZX20-B-SLDC	242-0022-1	4,000 pcs/reel

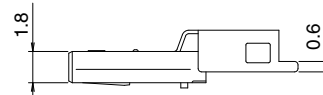
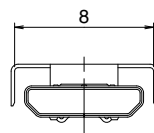
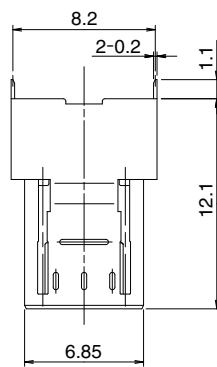

● Assembled

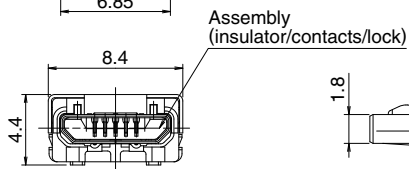
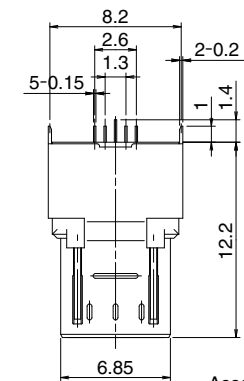

All dimensions: mm

Plugs

● Micro B - Assembly (insulator/contacts/lock) - Right angle SMT

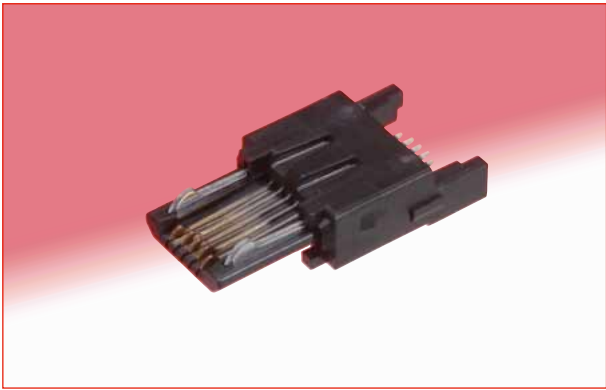

Part No.	HRS No.	Packaging
ZX64-B-5S-UNIT(14)	242-0009-3 14	1 piece

Contact HRS for Cable Termination Procedure Manual.

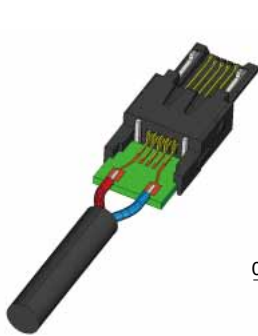

PCB mounting pattern
*PCB required (not supplied)
Max. thickness: 1.0mm

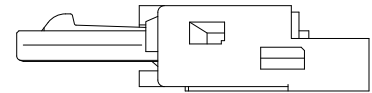
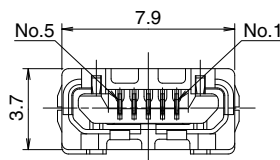
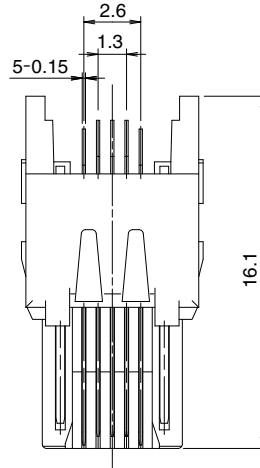
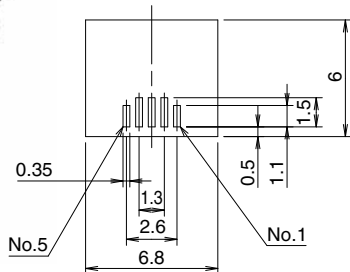

All dimensions: mm

● Micro B - Component, Cover-top – Right angle SMT

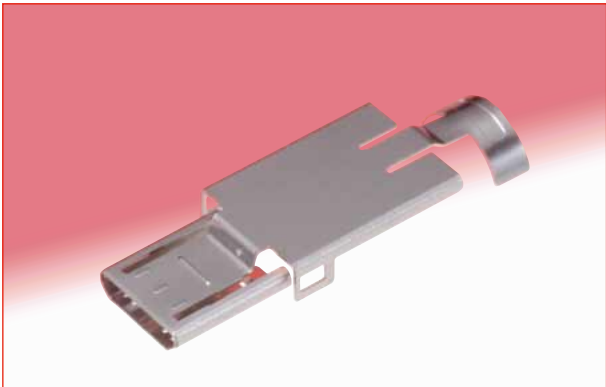

Part No.	HRS No.	Packaging
ZX64-B-SLDA	242-0013-0	4,000 pcs/reel

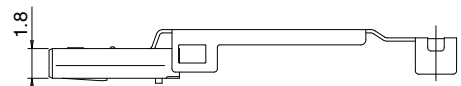
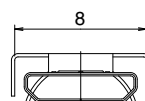
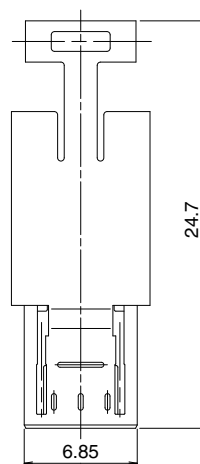

All dimensions: mm

Plugs

● Micro B - Component, Cover-bottom - Right angle SMT

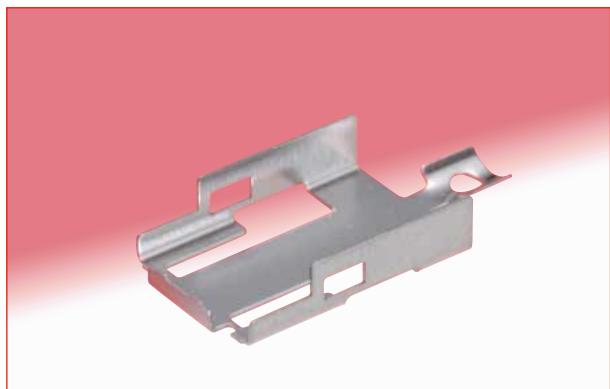

Part No.	HRS No.	Packaging
ZX64-SLDB	242-0049-8	4,000 pcs/reel

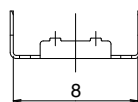
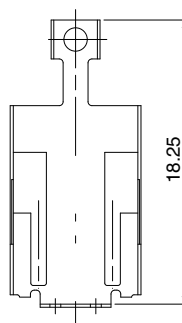

● Assembled



All dimensions: mm

● Micro B - Component, Shell/cover – Right angle SMT



Part No.	HRS No.	Packaging
ZX64-B-SLDC	242-0018-4	4,000 pcs/reel

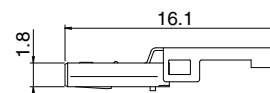
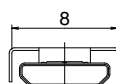
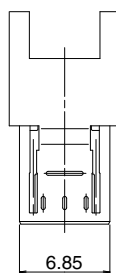

Shell/cover, without cable clamp
This shell/cover does not require ZX64-SLDB.

● Assembled

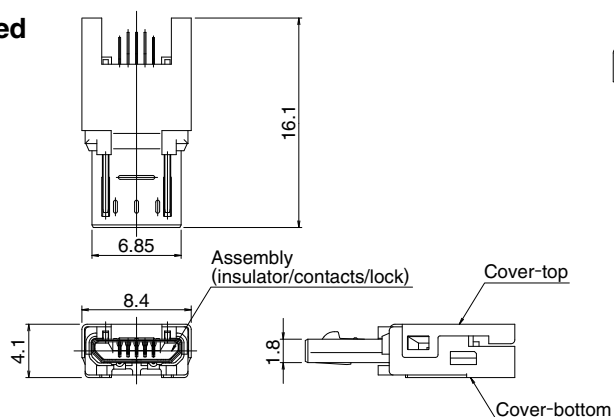

All dimensions: mm

■ Plugs

● Micro A - Assembly (insulator/contacts/lock) - Direct wire soldering

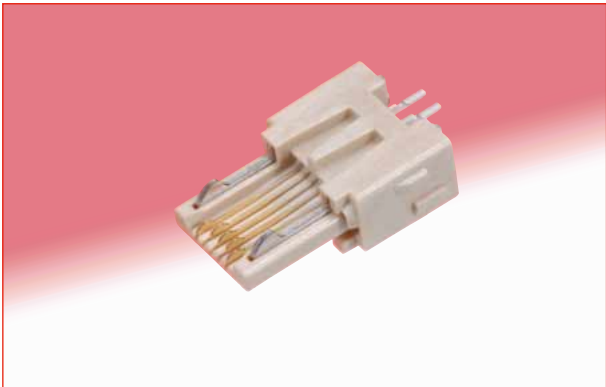

Part No.	HRS No.	Packaging
ZX40-A-5S-UNIT	242-0010-2	1 piece

Contact HRS for Cable Termination Procedure Manual.

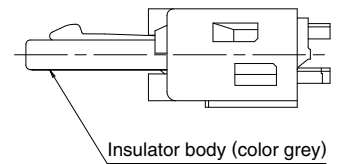
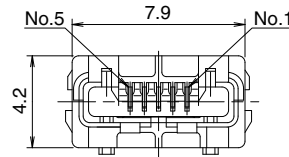
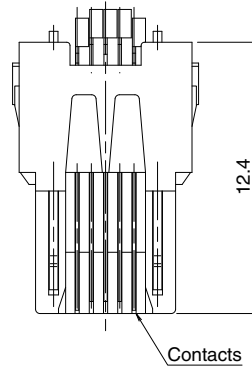

All dimensions: mm

● Micro A - Component, Cover-top - Direct wire soldering

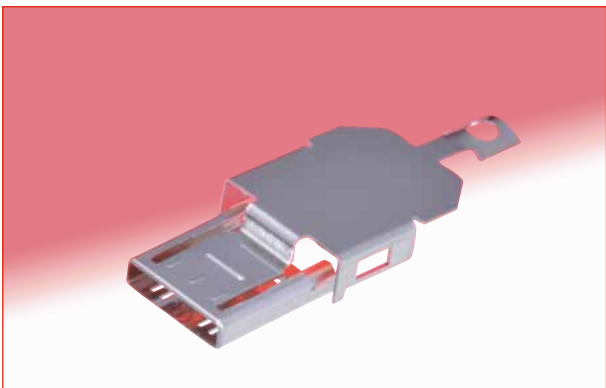

Part No.	HRS No.	Packaging
ZX40-A-SLDA	242-0011-5	4,000 pcs/reel

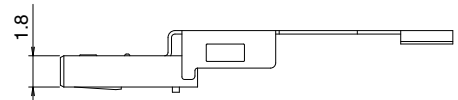
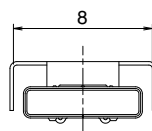
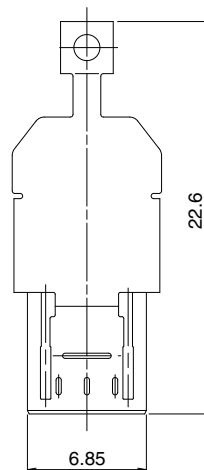

All dimensions: mm

Plugs

● Micro A, Micro B - Component, Cover-bottom - Direct wire soldering

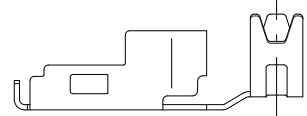
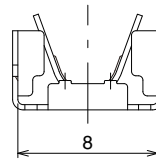
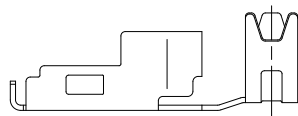
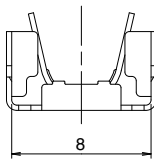
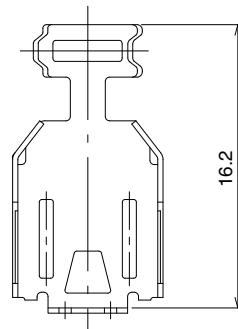
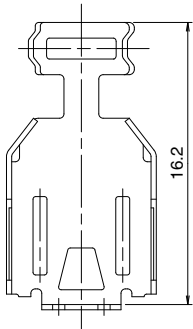
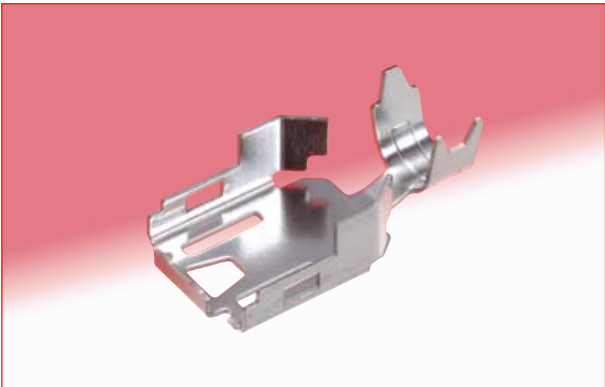

All dimensions: mm

ZX40-SLDB

ZX40-SLDB(3.3)

Part No.	HRS No.	Packaging	Cable dia.
ZX40-SLDB	242-0004-0	4,000 pcs/reel	φ3.8
ZX40-SLDB(3.3)	242-0023-4		φ3.3

● Assembled

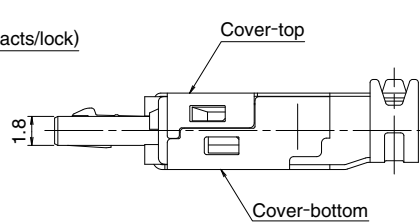
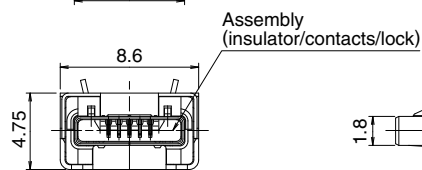
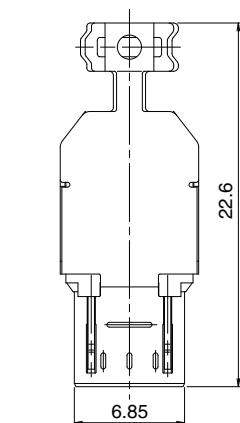

All dimensions: mm

■ Plug-Vertical, cradle mount, Shell through hole

● Micro B, with lock

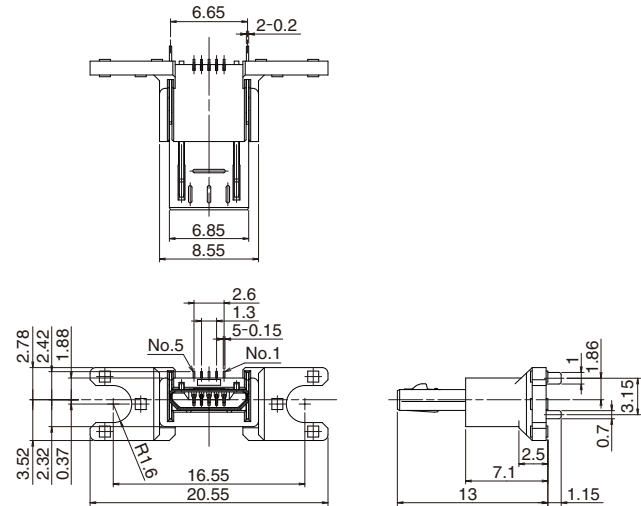
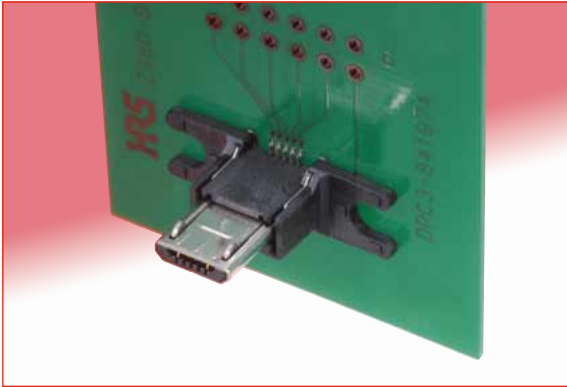

Part No.	HRS No.	Packaging
ZX80-B-5S	242-0017-1	100 pcs/pks

All dimensions: mm

● Micro B, without lock

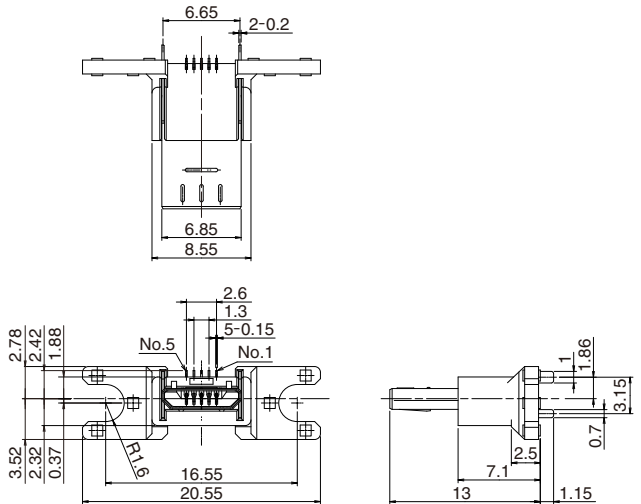
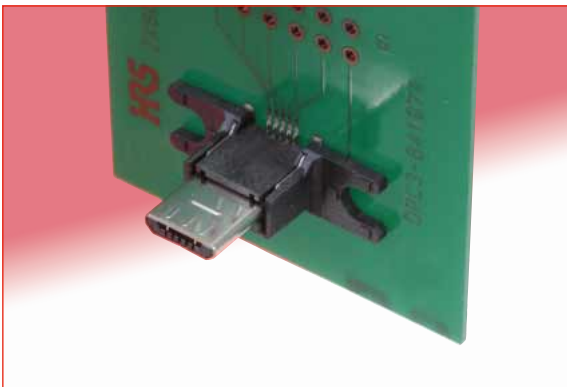

Part No.	HRS No.	Packaging
ZX80-B-5SA	242-0019-7	100 pcs/pks

◆ PCB mounting pattern

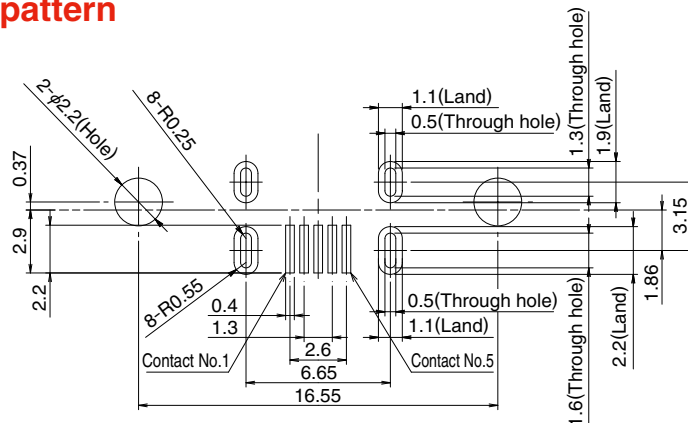

All dimensions: mm

◆ Packaging Specifications

● Embossed carrier tape dimensions

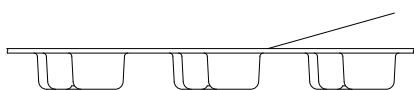

Part No.	A dimension	B dimension
ZX62-B-5PA(11)	24	11.5
ZX62-AB-5PA(11)	24	11.5
ZX62M-B-5P(01)	24	11.5
Other	16	7.5

● Reel Dimensions

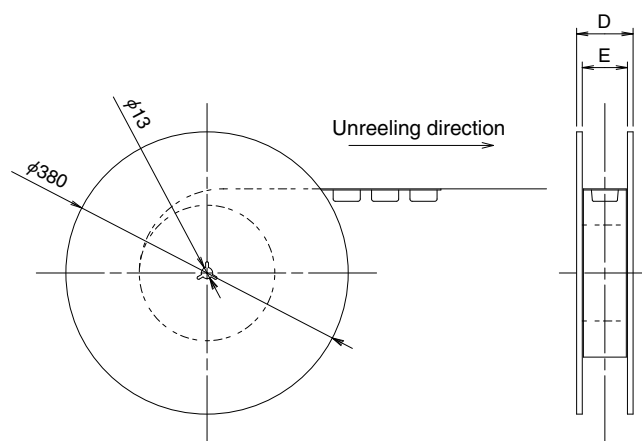

Part No.	D dimension	E dimension
ZX62-B-5PA(11)	30.4	24.4
ZX62-AB-5PA(11)	30.4	24.4
ZX62M-B-5P(01)	30.4	24.4
Other	22.4	16.4

◆ Recommended Temperature Profile - Receptacles

● Using lead-free solder paste

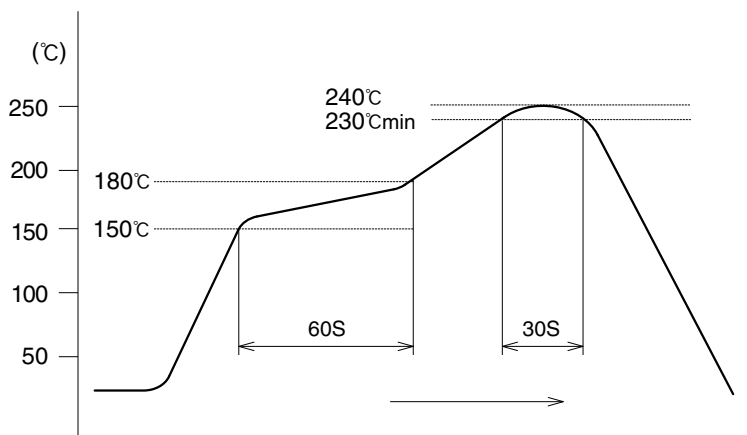

The temperature profile is based on the left conditions.

In individual applications the actual temperature may vary, depending on solder paste type, volume/thickness and board size/thickness. Contact your solder paste and equipment manufacturer for specific recommendations.

Note 1: Up to 2 cycles of Reflow soldering are possible under the same conditions, provided that there is a return to normal temperature between the first and second cycle.

Note 2: The temperature profile indicates the board surface temperature at the point of contacts with the connector terminals.

◆ Precautions

1. Exercise care when handling the connectors. Do not subject them to excessive external forces when mating/un-mating.
2. Mate and un-mate as intended, holding by the overmolded body, in the correct direction. Do not un-mate by pulling on the cable.
3. Some tooling marks may be visible on the surfaces of receptacle (shell/cover). No form/fit or function is affected.
4. Appearance of the surface finishes on the receptacles may vary between production runs. No affect on form, fit or function.

USA:

HIROSE ELECTRIC (U.S.A.), INC. Headquarters
2688 Westhills Court, Simi Valley, CA 93065-6235
Phone : +1-805-522-7958
Fax : +1-805-522-3217
<http://www.hiroseusa.com>

USA:

HIROSE ELECTRIC (U.S.A.), INC. San Jose Office
3255 Scott Boulevard, Building 7, Suite 101
Santa Clara, CA 95054
Phone : +1-408-253-9640
Fax : +1-408-253-9641
<http://www.hiroseusa.com>

USA:

HIROSE ELECTRIC (U.S.A.), INC. Detroit Office (Automotive)
37677 Professional Center Drive, Suite #100C
Livonia, MI 48154
Phone : +1-734-542-9963
Fax : +1-734-542-9964
<http://www.hiroseusa.com>

THE NETHERLANDS:

HIROSE ELECTRIC EUROPE B.V.
Hogehillweg #8 1101 CC Amsterdam Z-O
Phone : +31-20-6557460
Fax : +31-20-6557469
<http://www.hiroseeurope.com>

GERMANY:

HIROSE ELECTRIC EUROPE B.V. German Branch
Herzog-Carl-Strasse 4 D-73760 Ostfildern
(Scharnhauser Park)
Phone : +49-711-4560-02-1
Fax : +49-711-4560-02-299
<http://www.hirose.de>

GERMANY:

HIROSE ELECTRIC EUROPE B.V. Nuernberg Office
Muggenhofer Str. 136 90429 Nuernberg
Phone : +49-911 32 68 89 63
Fax : +49-911 32 68 89 69
<http://www.hirose.de>

UNITED KINGDOM:

Hirose Electric Europe BV (UK Branch)
4 Newton Court, Kelvin Drive, Knowlhill,
Milton Keynes, MK5 8NH
Phone : +44-1908 202050
Fax : +44-1908 202058

CHINA:

HIROSE ELECTRIC (SHANGHAI) CO., LTD.
1601, Henderson Metropolitan, NO.300, East Nanjing
Road, Huangpu District, Shanghai, China 200001
Phone : +86-21-6391-3355
Fax : +86-21-6391-3335
<http://www.hirose-china.com.cn>

CHINA:

HIROSE ELECTRIC (SHANGHAI) CO.,LTD. BEIJING BRANCH
A1001, Ocean International Center, Building 56# East 4th
Ring Middle Road, ChaoYang District, Beijing, 100025
Phone : +86-10-5165-9332
Fax : +86-10-5908-1381
<http://www.hirose-china.com.cn>

CHINA:

HIROSE ELECTRIC TECHNOLOGIES (SHENZHEN) CO., LTD.
Room 09-13, 19/F, Office Tower Shun Hing Square, Di Wang Commercial Centre,
5002 Shen Nan Dong Road, Shenzhen City, Guangdong Province, 518008
Phone : +86-755-8207-0851
Fax : +86-755-8207-0873
<http://www.hirose-china.com.cn>

HONG KONG:

HIROSE ELECTRIC HONGKONG TRADING CO., LTD.
Room 1001, West Wing, Tsim Sha Tsui Centre, 66
Mody Road, Tsim Sha Tsui East, Kowloon, Hong Kong
Phone : +852-2803-5338
Fax : +852-2591-6560
<http://www.hirose-hongkong.com.hk>

TAIWAN:

HIROSE ELECTRIC TAIWAN CO., LTD.
103 8F, No.87, Zhengzhou Rd., Taipei
Phone : +886-2-2555-7377
Fax : +886-2-2555-7350
<http://www.hirose-taiwan.com.tw>

KOREA:

HIROSE KOREA CO., LTD.
1261-10, Jeoungwhang-Dong, Shihung-City,
Kyunggi-Do 429-450
Phone : +82-31-496-7000,7124
Fax : +82-31-496-7100
<http://www.hirose.co.kr>

SINGAPORE:

HIROSE ELECTRIC SINGAPORE PTE. LTD.
10 Anson Road #26-1, International Plaza
079903, Singapore
Phone : +65-6324-6113
Fax : +65-6324-6123
<http://www.hirose-singapore.com.sg>

INDIA:

HIROSE ELECTRIC SINGAPORE PTE. LTD Delhi Liaison Office
Suite No. 606 5th Floor SB Tower 1A/1 Sector
16 A Filmcity Noida 201301 Uttar Pradesh-India
Phone : +91-120-4804917
Fax : +91-120-4804949
<http://www.hirose.com/sg/>

INDIA:

HIROSE ELECTRIC SINGAPORE PTE. LTD. Bangalore Liaison office
Unit No.03, Ground Floor, Explorer Building International Tech
Park Whitefield Road, Bangalore 560066 Karnataka, India
Phone : +91-80-4120 1907
Fax : +91-80-4120 9908
<http://www.hirose-singapore.com.sg>

MALAYSIA:

HIROSE ELECTRIC SINGAPORE PTE. LTD (Representative office)
1-10-07, Suntech @ Penang Cybercity (1164),Lintang
Mayang Pasir 3,11950, Bayan Baru, Penang, Malaysia.
Phone : +604-619-2564
Fax : +604-619-2574
<http://www.hirose.com/sg/>



HIROSE ELECTRIC CO.,LTD.

2-6-3,Nakagawa Chuoh,Tsuzuki-Ku,Yokohama-Shi 224-8540,JAPAN
TEL: +81-45-620-3526 Fax: +81-45-591-3726
<http://www.hirose.com>
<http://www.hirose-connectors.com>