

MICRO SWITCH™ GLS Global  
Miniature (EN50047) Limit Switches  
**GLC | GLD | GLE Series**



# MICRO SWITCH™ GLS Miniature (EN50047 Style) Limit Switches

The Honeywell MICRO SWITCH™ GLS miniature limit switch family offers a wide range of products for global solutions. These durable and reliable limit switches are suitable for many industrial applications, agriculture equipment, transportation equipment, and other applications requiring an environmentally sealed (IP and NEMA) switch.

The compact housings are often ideal for equipment where space is at a premium. The extensive product range is available in three different housing types; metal housing, plastic housing or a three conduit metal housing which are mounting compatible to EN50047. A wide range of actuators, contact blocks, and conduit/connectivity options enhance the product offering.

In today's demanding age of logic-level controls, electromechanical switches are frequently used to interface with PLCs and other logic level devices. GLS limit switches offer an option for gold-plated contacts for the standard switch. This option promotes the switch reliability for logic-level applications.

## *What makes our switches better?*

- Meets EN50047 mounting standards and EN/IEC electrical standards for world-wide use
- Large existing install base and channel allows for quick delivery worldwide
- Wide range of actuators and circuitry options in same footprint
- Certified for global use with CCC, CSA, CE, and UL acceptance

***Miniature global limit switch  
with heavy-duty ratings.***



EASY TO INSTALL AND MAINTAIN • GLOBAL  
RUGGED CONSTRUCTION • BUILT TO FIT

# Features and Benefits

## HOUSING MATERIAL OPTIONS

MICRO SWITCH™ GLS limit switches are manufactured with either a **metal housing** or **double-insulated plastic housing** for indoor and outdoor applications.

## FLEXIBLE OPERATING HEADS

Full range of actuator heads can be positioned at **90° increments** for design flexibility. Side rotary actuator heads can be **factory set for CW, CCW, or CW and CCW actuation** to meet application requirements.

*Removable contact block for wiring ease.*

## BUILT FOR LONG LIFE

**Dual bearing design** on side rotary actuators reduces side loading and enhances mechanical life.

## CIRCUITRY OPTIONS

Wide variety of normally closed and normally open double-break snap-action or slow-action contact options are available with **silver contacts for power switching** or **gold-plated contacts for low energy loads**.

*Galvanically isolated contacts for controlling two separate circuits.*

## CIRCUIT FLEXIBILITY

Normally closed double break **direct opening contacts**  conform to EN/IEC 60947-5-1-3 to provide forced opening of the normally closed contact. Each **contact throw is electrically isolated** to accept different voltages (Form Zb contacts) which provides circuit flexibility. Double pole double throw (2NC/2NO) contact option require same polarity for each pole. (Form Za for each pole).

## LOW TEMPERATURE FOR SEVERE ENVIRONMENTS

**-40 °C [-40 °F] standard construction** for side rotary and plunger actuated switches are suitable for many severe outdoor environments.

## GLOBAL ACCEPTANCE

With sealing up to **IP66** and **NEMA 4** for hostile environments, MICRO SWITCH™ GLS Series switches also carry **CE, UL, CSA, CCC** certification for global use.

## Potential Applications



### **PASSENGER ELEVATORS**

Buffer actuation, top stop, floor detection

### **COMMERICAL APPLIANCES**

Door interlock switch

### **ESCALATORS/MOVING STAIRS**

Side skirt detection, loose or missing tread, comb detection



### **SCISSOR/PLATFORM LIFTS**

Pothole detection, outrigger position, boom extend/retract

### **MATERIAL HANDLING**

Overhead doors

### **MACHINE TOOL EQUIPMENT**

Part presence, machine slide/table position, panel and door presence



### **OFF-ROAD EQUIPMENT**

- Agriculture planting and tillage equipment, stow position
- Road construction equipment, panel & door interlock switches
- Rail passenger door interlock switch
- Position of motorized railroad switch

# MICRO SWITCH™ GLS Global Miniature (EN50047 Style) Limit Switches

## MICRO SWITCH™ GLS SERIES PRODUCT NOMENCLATURE

GL	C	A	01	A1A	L	
Switch Type	Body	Conduit	Basic Switch	Head/Actuator	Modification Codes For Actuator types beginning with A*	
<b>GLS Series</b> Global Limit Switch	<b>C</b> Metal, miniature	<b>A</b> 1/2-14 NPT	<b>01</b> SPDT snap action	<b>A1A</b> Side rotary, fixed, 19 mm x 6 mm nylon roller	<b>E7B</b> Wobble, coil spring	<b>1</b> CW rotation only
	<b>D</b> Plastic, miniature	<b>B</b> PG 13.5	<b>03</b> SPDT, BBM slow acting	<b>A1B</b> Side rotary, fixed, 19 mm x 6 mm steel roller	<b>F</b> <sup>Δ</sup> Adj. top roller lever, Ø27,3 mm x 5 mm roller	<b>2</b> CCW rotation only
	<b>E</b> Metal, three conduit	<b>C</b> 20 mm	<b>04</b> SPDT, MBB slow acting	<b>A2A</b> Side rotary, adjust., 19 mm x 6 mm nylon roller	<b>K8A</b> Cat whisker, 140 mm	<b>3</b> Lever to right
			<b>05</b> DPST, 2NO slow acting	<b>A2B</b> Side rotary, adjust., 19 mm x 6 mm steel roller	<b>K8B</b> Cat whisker, 190 mm	<b>4</b> Lever to left
			<b>06</b> DPST, 2NC slow acting	<b>A4J</b> Side rotary, adjust., 140 mm aluminum rod	<b>K8D</b> Cat whisker, 165 mm	<b>5</b> Lever to mounting surf.
			<b>07</b> SPDT, snap action, gold cont.	<b>A4L</b> Side rotary, adjust., 200 mm aluminum rod	<b>A1</b> Side rotary, fixed, no roller	for Actuator/Type C
			<b>24</b> DPDT, snap action, Body E	<b>A5A</b> Side rotary, offset, 19 mm x 6 mm nylon roller	<b>A2</b> Side rotary, adjustable, no roller	<b>6</b> Roller perpendicular to mtg. surf.
			<b>32</b> DPDT, snap action, gold cont. Body E	<b>A5B</b> Side rotary, offset, 19 mm x 6 mm steel roller	<b>A1Y</b> Side rotary, fixed, 50 mm x 10 mm rubber roller	for Actuator/Type D
			<b>33</b> SPDT, BBM slow acting, gold contacts	<b>A9A</b> Side rotary, conveyor lever	<b>A2Y</b> Side rotary, adj., 50 mm x 10 mm rubber roller	<b>4</b> Lever to right, hinge to left
			<b>34</b> SPDT, MBB slow acting, gold contacts	<b>B</b> Top pin plunger	<sup>Δ</sup> Available with D style body (plastic) only.	
			<b>35</b> DPST, 2NO slow acting, gold contacts	<b>C</b> Top roller plunger		
			<b>36</b> DPST, 2NC slow acting, gold contacts	<b>D</b> Top roller lever		

NOTE: not all combinations of model codes are available. Please contact your Honeywell provider/representative for assistance.

\*For Type A modification codes, more than one code may be permissible. For example, GLCA01A1B-13 is a side rotary, lever-actuated switch, GLCA01A1B, adjusted for clockwise actuation only. The operating shaft is to the right side of the switch when viewing the switch from the front (label side).

# GLS Series

**Table 1. Specifications**

Characteristic	Parameter
Housing material	GLC Series and GLE Series: Electrostatic epoxy coated zinc GLD Series: High-strength glass re-enforced thermoplastic
Actuators	Side rotary, top pin plunger, top roller plunger, top roller lever, top wobble actuator
Termination	0.5-14 NPT, PG 13,5, M20, PF 1/2, Deutsch style 4-pin connector other cable/connector options available, contact the Honeywell Representative
Contact options*	GLC metal housing and GLD plastic housing: 1NC/1NO, 2NC, 2NO GLE metal housing, 1NC/1NO, 2NC, 2NO, 2NC/2NO
Contact type	snap-action, slow-action break-before-make (BBM), slow-action make-before-break (MBB), slow action
Contact material	silver (standard), gold plated (low-energy applications)
Thermal current (Ith)	10 A
Rated insulation voltage	300 V
Rated impulse voltage	2.5 kV
Sealing	NEMA 1, 4, 12, 13; IP66
Operating temperature	-40 °C to 85 °C [-40 °F to 185 °F]
Mechanical life	Up to 10 million cycles
Pollution code	3
Max. actuation frequency	250 operations/minute; 100 operations/minute (wobbles)
Shock	50 g per IEC 60068-2-27
Vibration	10 g per IEC 60068-2-6
Approvals	CE, UL, CSA and CCC
Conforming to standards	CE, EN50047, IEC/EN 60947-5-1; CSA C22.2 #14; UL 508; CCC GB14048.5

\*All normally closed contacts are positive opening (→).

The two contact elements are Zb (electrically separated) except the 2NC/2NO contacts requires same polarity each pole (Za).



**Table 2. Electrical Ratings**

IEC 60947-5-1 (EN60947-5-1) AC 15, A300; DC 13, Q300

Silver Contacts						Gold Contacts	
ac				dc			
A300 Ue	AC15 Ie	VA		Q300 Ue	DC13 Ie	VA	
Volts	Amps	Make	Break	Volts	Amps	Make	Break
120	6	7200	720	125	0.55	69	69
240	3	7200	720	250	0.27	69	69

1 V 10 μA min.  
50 V 100 mA max.

# MICRO SWITCH™ GLS Global Miniature (EN50047 Style) Limit Switches

## MICRO SWITCH™ GLC SERIES ORDER GUIDE/RECOMMENDED LISTINGS

For listings not shown, contact your Honeywell representative.

Table 3. Side Rotary, Plastic Roller

Contacts	Contact Type	Contact Mtl	Conduit	Oper. Torque	Bar Chart <sup>1</sup>	Listing
1NC/1NO	Snap action 	Silver	0.5-14 NPT	0,12 Nm max. [1.1 in-lb max.]		GLCA01A1A
		Silver	PG 13,5			GLCB01A1A
		Silver	M20			GLCC01A1A
		Gold plated	M20			GLCC07A1A
1NC/1NO	BBM, slow action 	Silver	0.5-14 NPT	0,11 Nm max. [1.0 in-lb max.]		GLCA03A1A
2 NO	Slow action 	Silver	0.5-14 NPT	0,11 Nm max. [1.0 in-lb max.]		GLCA05A1A

<sup>1</sup>Contact closed ■; Contact open □. \*Positive opening occurs.

Table 4. Side Rotary, Metal Roller

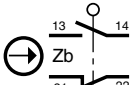
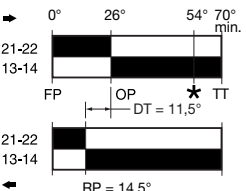
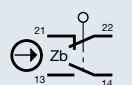
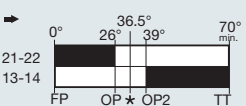
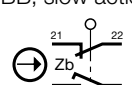
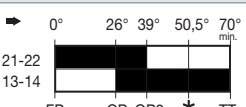
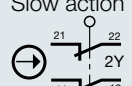
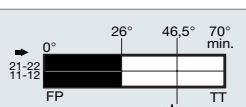
Contacts	Contact Type	Contact Mtl	Conduit	Oper. Torque	Bar Chart <sup>1</sup>	Listing
1NC/1NO	Snap action 	Silver	0.5-14 NPT	0,12 Nm max. [1.1 in-lb max.]		GLCA01A1B
		Silver	PG 13,5			GLCB01A1B
		Silver	M20			GLCC01A1B
		Gold plated	PG 13,5			GLCB07A1B
		Gold plated	M20			GLCC07A1B
1NC/1NO	BBM, slow action 	Silver	0.5-14 NPT	0,11 Nm max. [1.0 in-lb max.]		GLCA03A1B
			PG 13,5			GLCB03A1B
1NC/1NO	MBB, slow action 	Silver	0.5-14 NPT	0,11 Nm max. [1.0 in-lb max.]		GLCA04A1B
			PG 13,5			GLCB04A1B
2 NC	Slow action 	Silver	PG 13,5	0,11 Nm max. [1.0 in-lb max.]		GLCB06A1B

<sup>1</sup>Contact closed ■; Contact open □. \*Positive opening occurs.

Table 5. Side Rotary Adjustable, Plastic Roller

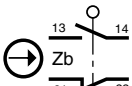
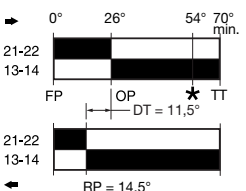
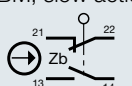
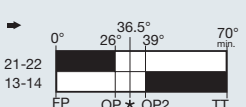
Contacts	Contact Type	Contact Mtl	Conduit	Oper. Torque	Bar Chart <sup>1</sup>	Listing
1NC/1NO	Snap action 	Silver	0.5-14 NPT	0,12 Nm max. [1.1 in-lb max.]		GLCA01A2A
		Silver	PG 13,5			GLCB01A2A
		BBM, slow action 	Silver	PG 13,5	0,11 Nm max. [1.0 in-lb max.]	

<sup>1</sup>Contact closed ■; Contact open □. \*Positive opening occurs.

# GLS Series

## MICRO SWITCH™ GLC SERIES ORDER GUIDE/RECOMMENDED LISTINGS

For listings not shown, contact your Honeywell representative.

Table 6. Side Rotary Adjustable, Metal Roller

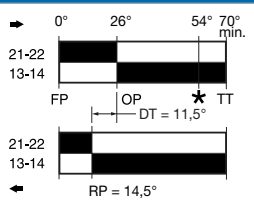
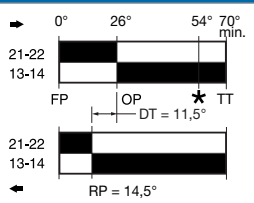
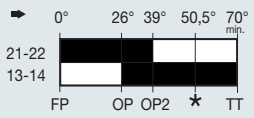
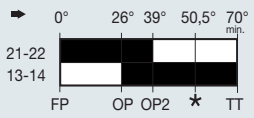
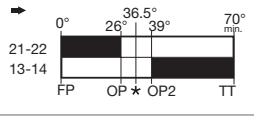
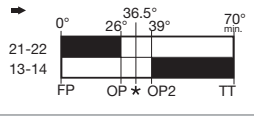
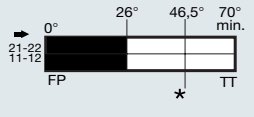
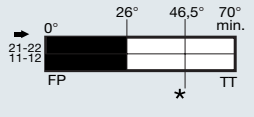
	Contacts	Contact Type	Contact Mtl	Conduit	Oper. Torque	Bar Chart <sup>1</sup>	Listing
	1NC/1NO	Snap action 	Silver	0.5-14 NPT	0,12 Nm max. [1.1 in-lb max.]		GLCA01A2B
			Silver	PG 13,5			GLCB01A2B
			Gold plated	PG 13,5			GLCB07A2B
			Silver	M20			GLCC01A2B
			Gold plated	M20			GLCC07A2B
1NC/1NO	MBB, slow action 	Silver	0.5-14 NPT	0,11 Nm max. [1.0 in-lb max.]		GLCA04A2B	
1NC/1NO	BBM, slow action 	Silver	M20	0,11 Nm max. [1.0 in-lb max.]		GLCC03A2B	
2NC	Slow action 	Silver	PG 13,5	0,11 Nm max. [1.0 in-lb max.]		GLCB06A2B	

<sup>1</sup>Contact closed ■; Contact open □. \*Positive opening occurs.

Table 7. Side Rotary Adjustable, Metal Rod, A4J (140 mm rod) and A4L (200 mm rod)

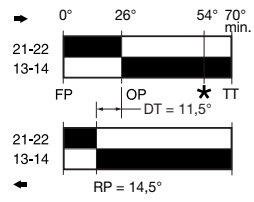
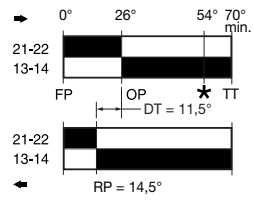
	Contacts	Contact Type	Contact Mtl	Conduit	Oper. Torque	Bar Chart <sup>1</sup>	Listing
	1NC/1NO	Snap action 	Silver	0.5-14 NPT	0,12 Nm max. [1.1 in-lb max.]		GLCA01A4J
				PG 13,5			GLCB01A4J
				M20			GLCC01A4J
				PG13,5			GLCB01A4L

<sup>1</sup>Contact closed ■; Contact open □. \*Positive opening occurs.

Table 8. Side Rotary Offset Lever, Metal Roller

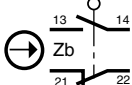
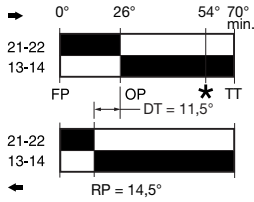
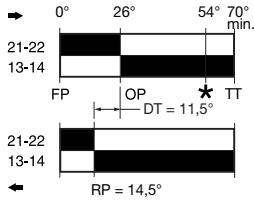
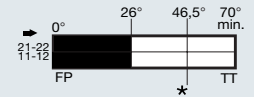
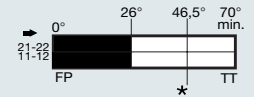
	Contacts	Contact Type	Contact Mtl	Conduit	Oper. Torque	Bar Chart <sup>1</sup>	Listing
	1NC/1NO	Snap action 	Silver	0.5-14NPT	0,12 Nm max. [1.1 in-lb max.]		GLCA01A5B
			Silver	PG 13,5			GLCB01A5B
	2NC	Slow action 	Silver	0.5-14 NPT	0,11 Nm max. [1.0 in-lb max.]		GLCA06A5B
			Gold plated	0.5-14 NPT			GLCA36A5B

<sup>1</sup>Contact closed ■; Contact open □. \*Positive opening occurs.



# MICRO SWITCH™ GLS Global Miniature (EN50047 Style) Limit Switches

## MICRO SWITCH™ GLC SERIES ORDER GUIDE/RECOMMENDED LISTINGS

For listings not shown, contact your Honeywell representative.

Table 9. Side Rotary Conveyor Lever, Ceramic Roller

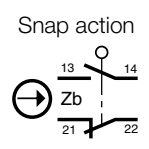
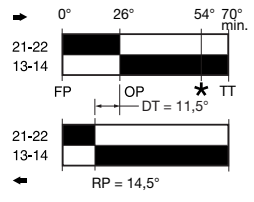
Contacts	Contact Type	Contact Mtl	Conduit	Oper. Torque	Bar Chart <sup>1</sup>	Listing
	Snap action 	Silver	0.5-14 NPT	0,12 Nm max. [1.1 in-lb max.]		<b>GLCA01A9A</b>
			PG 13,5			<b>GLCB01A9A</b>
			M20			<b>GLCC01A9A</b>

<sup>1</sup>Contact closed ■; Contact open □. \*Positive opening occurs.

Table 10. Top Pin Plunger

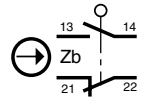
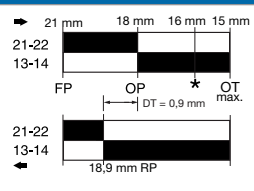
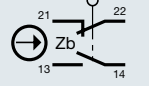
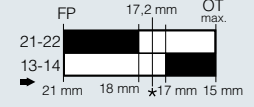
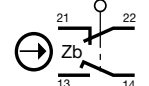
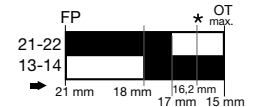
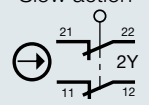
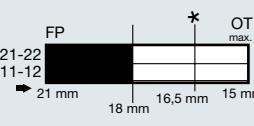
Contacts	Contact Type	Contact Mtl	Conduit	Oper. Force	Bar Chart <sup>1</sup>	Listing
	Snap action 	Silver	0.5-14 NPT	16 N max. [3.6 lb max.]		<b>GLCA01B</b>
		Silver	PG 13,5			<b>GLCB01B</b>
		Silver	M20			<b>GLCC01B</b>
		Gold plated	PG 13,5			<b>GLCB07B</b>
1NC/1NO	BBM, slow action 	Silver	0.5-14 NPT	14 N max. [3.2 lb max.]		<b>GLCA03B</b>
		PG 13,5		<b>GLCB03B</b>		
1NC/1NO	MBB, slow action 	Silver	0.5-14 NPT	16 N max. [3.6 lb max.]		<b>GLCA04B</b>
		PG 13,5		<b>GLCB04B</b>		
2 NC	Slow action 	Silver	PG 13,5	13 N max. [2.9 lb max.]		<b>GLCB06B</b>

<sup>1</sup>Contact closed ■; Contact open □. \*Positive opening occurs. NOTE: Bar chart measurements are in millimeters.

Table 11. Top Roller Plunger

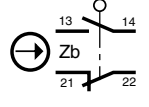
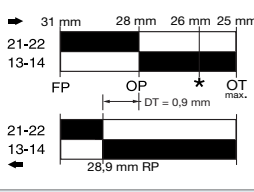
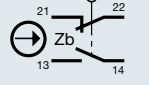
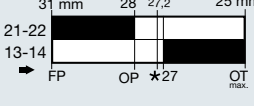
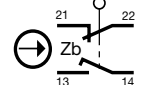
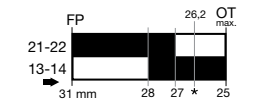
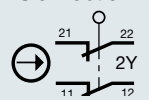
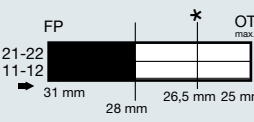
Contacts	Contact Type	Contact Mtl	Conduit	Oper. Force	Bar Chart <sup>1</sup>	Listing
	Snap action 	Silver	0.5-14 NPT	16 N max. [3.6 lb max.]		<b>GLCA01C</b>
		Silver	PG 13,5			<b>GLCB01C</b>
		Gold plated	PG 13,5			<b>GLCB07C</b>
		Silver	M20			<b>GLCC01C</b>
1NC/1NO	BBM, slow action 	Silver	0.5-14 NPT	14 N max. [3.2 lb max.]		<b>GLCA03C</b>
		PG 13,5		<b>GLCB03C</b>		
1NC/1NO	MBB, slow action 	Silver	PG 13,5	16 N max. [3.6 lb max.]		<b>GLCB04C</b>
2NC	Slow action 	Silver	PG 13,5	13 N max. [2.9 lb max.]		<b>GLCB06C</b>
		Gold plated	PG 13,5			<b>GLCB36C</b>
		Silver	M20			<b>GLCC06C</b>

<sup>1</sup>Contact closed ■; Contact open □. \*Positive opening occurs. NOTE: Bar chart measurements are in millimeters.

# GLS Series

## MICRO SWITCH™ GLC SERIES ORDER GUIDE/RECOMMENDED LISTINGS

For listings not shown, contact your Honeywell representative.

Table 12. Top Roller Lever

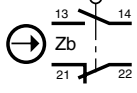
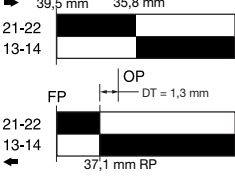
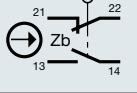
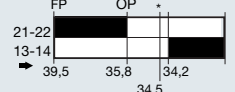
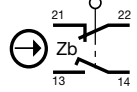
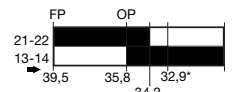
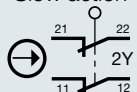
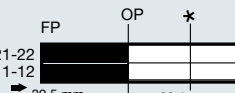
	Contacts	Contact Type	Contact Mtl	Conduit	Oper. Force	Bar Chart <sup>1</sup>	Listing
	1NC/1NO	Snap action 	Silver	0.5-14 NPT	10 N max. [2.2 lb max.]		GLCA01D
			Silver	PG 13,5			GLCB01D
			Gold plated	PG 13,5			GLCB07D
			Silver	M20			GLCC01D
1NC/1NO	BBM, slow action 	Silver	0.5-14 NPT	9 N max. [2.0 lb max.]		GLCA03D	
		Silver	PG 13,5			GLCB03D	
		Gold plated	PG 13,5			GLCB33D	
1NC/1NO	MBB, slow action 	Silver	PG 13,5	10 N max. [2.2 lb max.]		GLCB04D	
2NC	Slow action 	Silver	M20	8 N max. [1.8 lb max.]		GLCC06D	
		Gold plated	0.5-14 NPT			GLCA36D	

<sup>1</sup>Contact closed ■; Contact open □. \*Positive opening occurs. NOTE: Bar chart measurements are in millimeters.

Table 13. Coil Spring Wobble, 130 mm

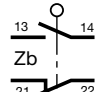
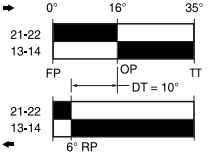
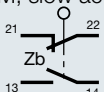
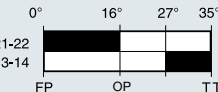
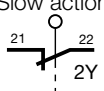
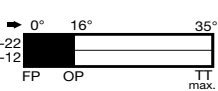
	Contacts	Contact Type	Contact Mtl	Conduit	Oper. Force	Bar Chart <sup>1</sup>	Listing
	1NC/1NO	Snap action 	Silver	0.5-14 NPT	1,3 N max. [0.29 lb] max.		GLCA01E7B
			Silver	PG 13,5			GLCB01E7B
			Silver	M20			GLCC01E7B
			Gold plated	PG 13,5			GLCB07E7B
1NC/1NO	BBM, slow action 	Silver	0.5-14 NPT	1,1 N max. [0.25 lb] max.		GLCA03E7B	
2NC	Slow action 	Silver	0.5-14 NPT	1,1 N max. [0.25 lb] max.		GLCA06E7B	

<sup>1</sup>Contact closed ■; Contact open □.

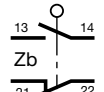
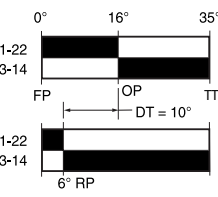
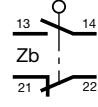
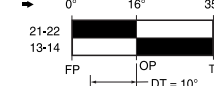

Table 14. Cat Whisker Wobble, 140 mm

	Contacts	Contact Type	Contact Mtl	Conduit	Oper. Force	Bar Chart <sup>1</sup>	Listing
	1NC/1NO	Snap action 	Silver	0.5-14 NPT	0,9 N max. [0.19 lb] max.		GLCA01K8A
				PG 13,5			GLCB01K8A

<sup>1</sup>Contact closed ■; Contact open □.

# MICRO SWITCH™ GLS Global Miniature (EN50047 Style) Limit Switches

Table 15. Cat Whisker Wobble, 190 mm

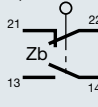
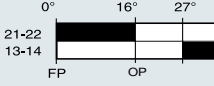
	Contacts	Contact Type	Contact Mtl	Conduit	Oper. Force	Bar Chart <sup>1</sup>	Listing
	1NC/1NO	Snap action 	Silver	0.5-14 NPT	0,9 N max. [0.19 lb] max.		<b>GLCA01K8B</b>
				PG 13,5			
	1NC/1NO	BBM, slow action 	Silver	0.5-14 NPT	0,7 N max. [0.16 lb] max.		<b>GLCA03K8B</b>

<sup>1</sup>Contact closed ■; Contact open □.

Figure 1. GLC Side Rotary • A1, A1A, A1B, and A1Y

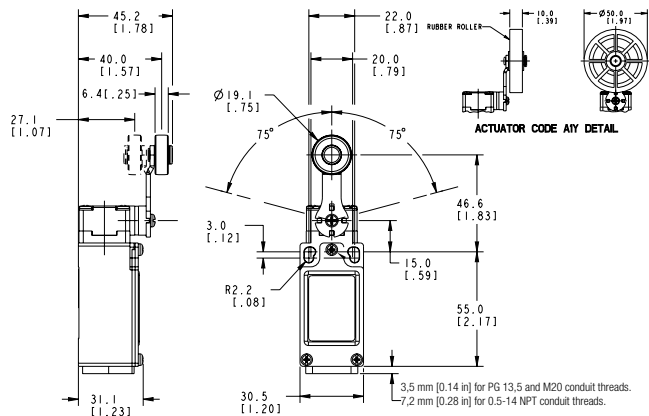

Figure 2. GLC Side Rotary • A2, A2A, A2B, and A2Y

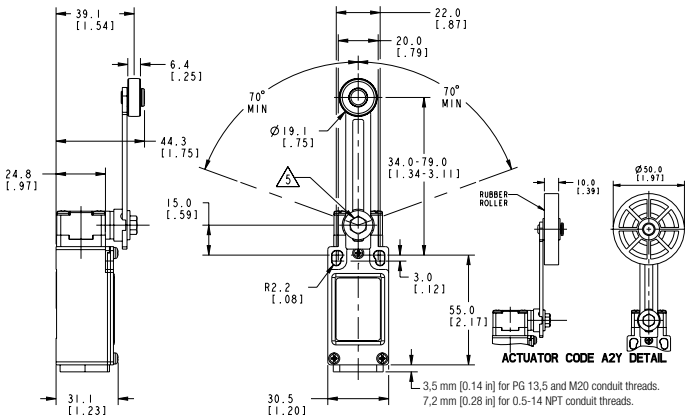

Figure 3. GLC Side Rotary Rod • A4J (140 mm) & A4L (200 mm)

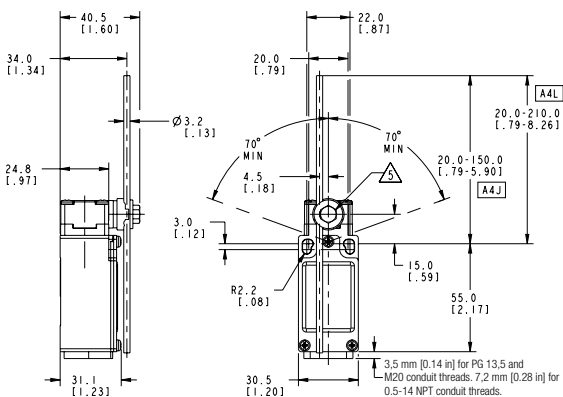

Figure 4. GLC Side Rotary • A5A and A5B

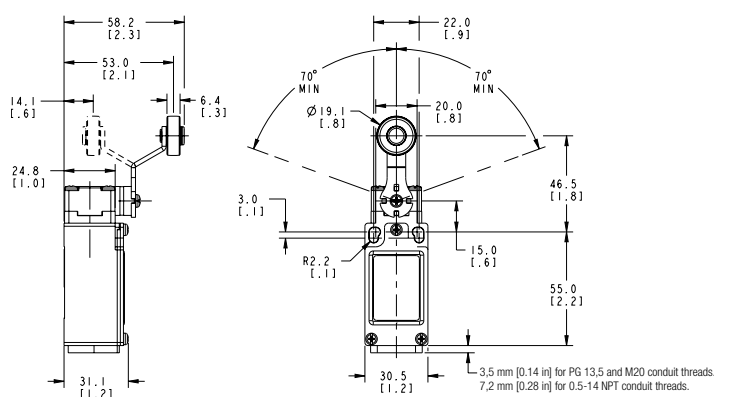

Figure 5. GLC Side Rotary • A9A

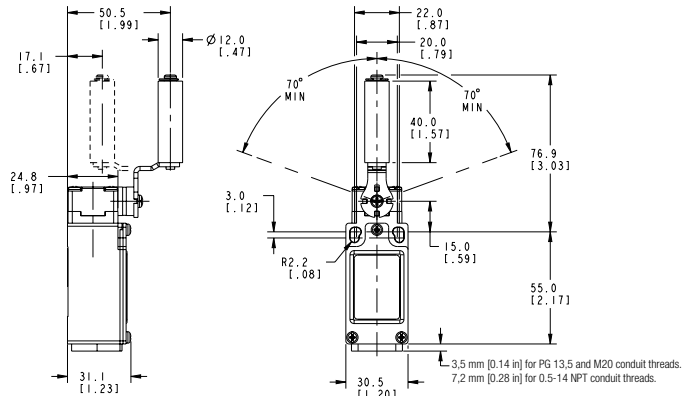
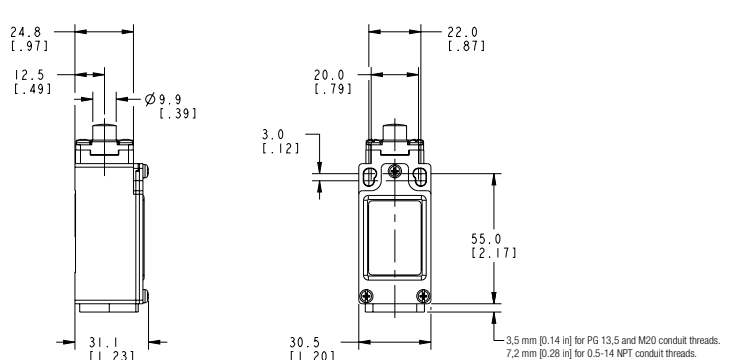
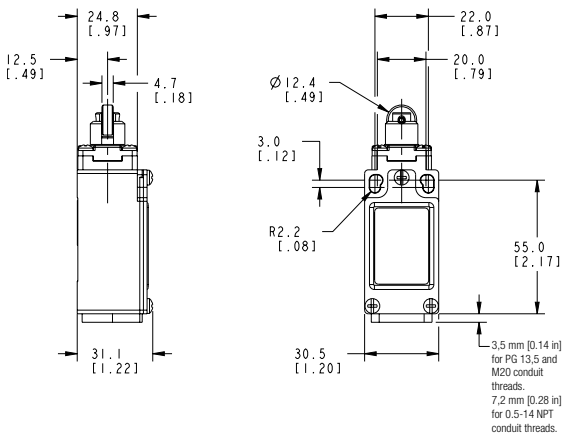

Figure 6. GLC Top Pin Plunger



# GLS Series

**Figure 7. GLC Top Roller Plunger**



**Figure 9. GLC Wobble • E7B**

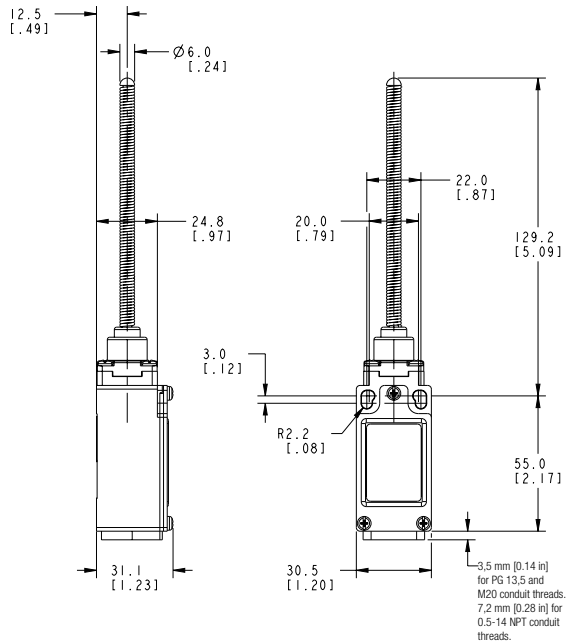

**Figure 8. GLC Top Roller Arm**

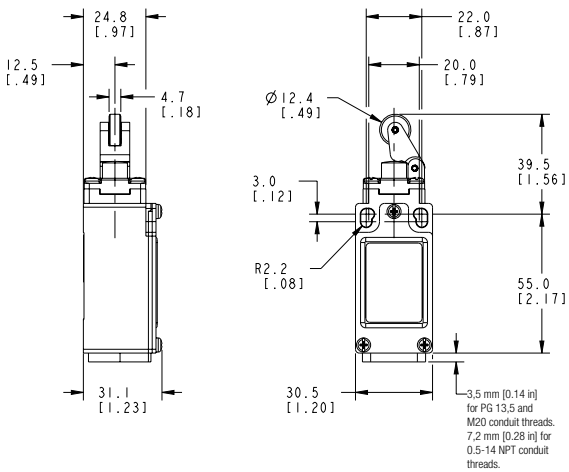

**Figure 10. GLC Wobble • K8A/K8B**

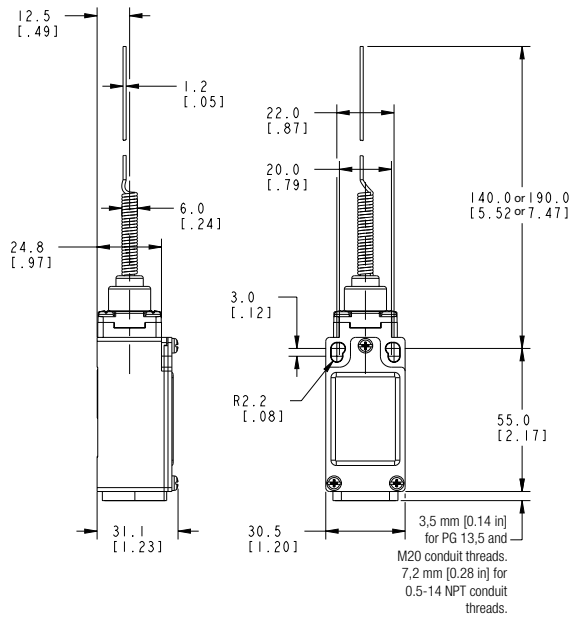

**Figure 11. GLC Conduit**

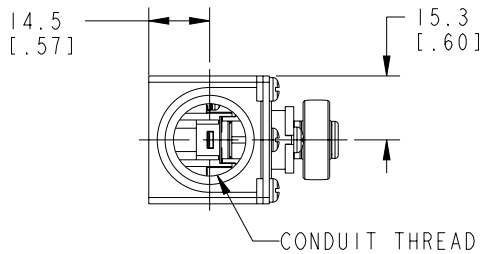



# MICRO SWITCH™ GLS Global Miniature (EN50047 Style) Limit Switches

## MICRO SWITCH™ GLD SERIES ORDER GUIDE/RECOMMENDED LISTINGS

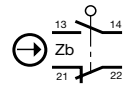
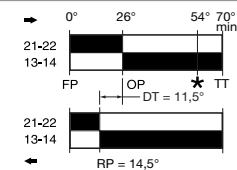
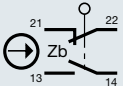
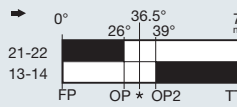
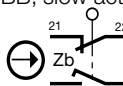
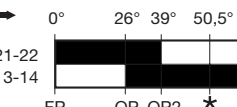
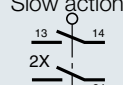
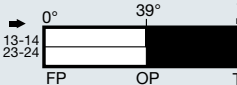
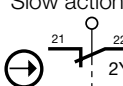

For listings not shown, contact your Honeywell representative.

Table 16. Side Rotary, Plastic Roller

Contacts	Contact Type	Contact Mtl	Conduit	Oper. Torque	Bar Chart <sup>1</sup>	Listing
1NC/1NO	Snap action 	Silver	0.5-14 NPT	0,12 Nm max. [1.1 in-lb max.]		GLDA01A1A
		Silver	PG 13,5			GLDB01A1A
		Gold plated	PG 13,5			GLDB07A1A
		Silver	M20			GLDC01A1A
1NC/1NO	BBM, slow action 	Silver	0.5-14 NPT	0,11 Nm max. [1.0 in-lb max.]		GLDA03A1A
			PG 13,5			GLDB03A1A
1NC/1NO	MBB, slow action 	Silver	PG 13,5	0,11 Nm max. [1.0 in-lb max.]		GLDB04A1A
2NO	Slow action 	Silver	M20	0,11 Nm max. [1.0 in-lb max.]		GLDC05A1A
2NC	Slow action 	Silver	M20	0,11 Nm max. [1.0 in-lb max.]		GLDC06A1A

<sup>1</sup>Contact closed ■; Contact open □. \*Positive opening occurs.

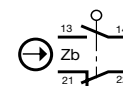
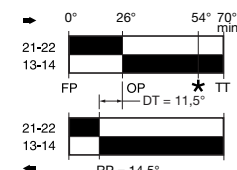
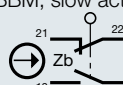
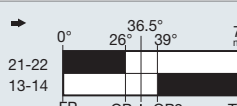
Table 17. Side Rotary, Metal Roller

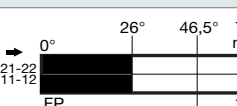
Contacts	Contact Type	Contact Mtl	Conduit	Oper. Torque	Bar Chart <sup>1</sup>	Listing
1NC/1NO	Snap action 	Silver	0.5-14 NPT	0,12 Nm max. [1.1 in-lb max.]		GLDA01A1B
		Silver	PG 13,5			GLDB01A1B
		Gold plated	PG 13,5			GLDB07A1B
		Silver	M20			GLDC01A1B
		Gold plated	M20			GLDC07A1B
1NC/1NO	BBM, slow action 	Silver	0.5-14 NPT	0,11 Nm max. [1.0 in-lb max.]		GLDA03A1B
			PG 13,5			GLDB03A1B
2NC	Slow action 	Silver	0.5-14 NPT	0,11 Nm max. [1.0 in-lb max.]		GLDA06A1B
			PG 13,5			GLDB06A1B
			M20			GLDC06A1B

<sup>1</sup>Contact closed ■; Contact open □. \*Positive opening occurs.

# GLS Series

## MICRO SWITCH™ GLD SERIES ORDER GUIDE/RECOMMENDED LISTINGS

For listings not shown, contact your Honeywell representative.

Table 18. Side Rotary Adjustable, Plastic Roller

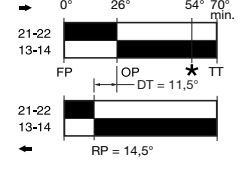
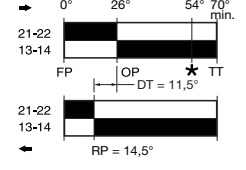
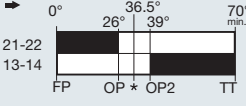
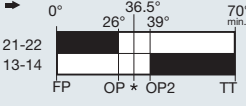
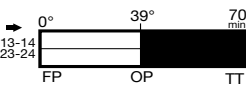
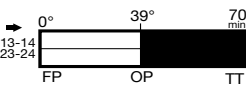
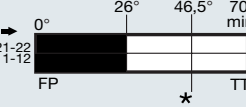
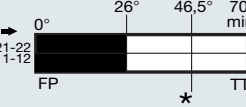
	Contacts	Contact Type	Contact Mtl	Conduit	Oper. Torque	Bar Chart <sup>1</sup>	Listing
	1NC/1NO	Snap action 	Silver	0.5-14 NPT	0,12 Nm max. [1.1 in-lb max.]		GLDA01A2A
				PG 13,5			GLDB01A2**
			PG 13,5	GLDB01A2A			
			M20	GLDC01A2A			
			Gold plated	PG 13,5			GLDB07A2A
	1NC/1NO	BBM, slow action 	Silver	PG 13,5	0,11 Nm max. [1.0 in-lb max.]		GLDB03A2A
	2NO	Slow action 	Silver	M20	0,11 Nm max. [1.0 in-lb max.]		GLDC05A2A
	2NC	Slow action 	Silver	0.5-14 NPT	0,11 Nm max. [1.0 in-lb max.]		GLDA06A2A
			Silver	PG 13,5			GLDB06A2A

<sup>1</sup>Contact closed ■; Contact open □. \*Positive opening occurs. \*\* No roller

Table 19. Side Rotary Adjustable, Metal Roller

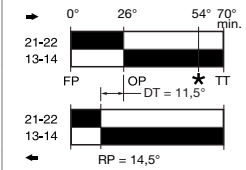
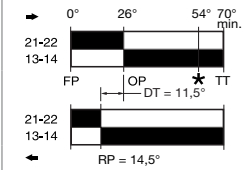
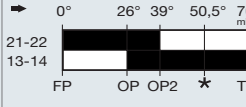
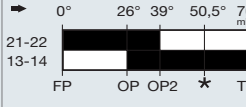
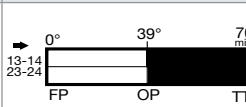
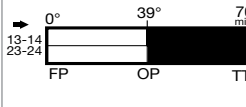
	Contacts	Contact Type	Contact Mtl	Conduit	Oper. Torque	Bar Chart <sup>1</sup>	Listing
	1NC/1NO	Snap action 	Silver	0.5-14 NPT	0,12 Nm max. [1.1 in-lb max.]		GLDA01A2B
			Gold plated	0.5-14 NPT			GLDA07A2B
			Silver	PG 13,5			GLDB01A2B
			Gold plated	PG 13,5			GLDB07A2B
			Silver	M20			GLDC01A2B
	1NC/1NO	MBB, slow action 	Silver	0.5-14 NPT	0,11 Nm max. [1.0 in-lb max.]		GLDA04A2B
	2NO	Slow action 	Silver	0.5-14 NPT	0,11 Nm max. [1.0 in-lb max.]		GLDA05A2B

<sup>1</sup>Contact closed ■; Contact open □. \*Positive opening occurs.

# MICRO SWITCH™ GLS Global Miniature (EN50047 Style) Limit Switches

## MICRO SWITCH™ GLD SERIES ORDER GUIDE/RECOMMENDED LISTINGS

For listings not shown, contact your Honeywell representative.

Table 20. Side Rotary Adjustable, Metal Rod

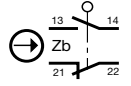
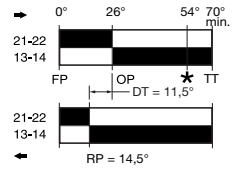
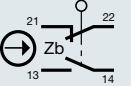
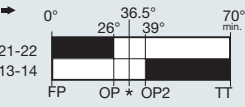
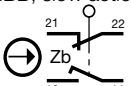
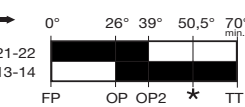
	Contacts	Contact Type	Contact Mtl	Conduit	Oper. Force	Bar Chart <sup>1</sup>	Listing
	1NC/1NO	Snap action 	Silver	0.5-14 NPT	0,12 Nm max. [1.1 in-lb max.]		GLDA01A4J
				PG 13,5			GLDB01A4J
				M20			GLDC01A4J
	1NC/1NO	BBM, slow action 	Silver	M20	0,11 Nm max. [1.0 in-lb max.]		GLDC03A4J
	1NC/1NO	MBB, slow action 	Silver	0.5-14 NPT	0,11 Nm max. [1.0 in-lb max.]		GLDA04A4J

<sup>1</sup>Contact closed ■; Contact open □. \*Positive opening occurs.

Table 21. Side Rotary Offset Lever, Metal Roller

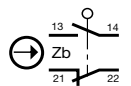
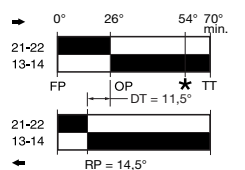
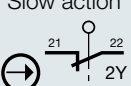
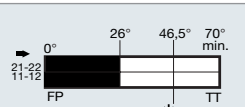
	Contacts	Contact Type	Contact Mtl	Conduit	Oper. Torque	Bar Chart <sup>1</sup>	Listing
	1NC/1NO	Snap action 	Silver	0.5-14NPT	0,12 Nm max. [1.1 in-lb max.]		GLDA01A5B
			Silver	PG 13,5			GLDB01A5B
			Silver	M20			GLDC01A5B
	2NC	Slow action 	Gold plated	PG 13,5	0,11 Nm max. [1.0 in-lb max.]		GLDB36A5B

<sup>1</sup>Contact closed ■; Contact open □. \*Positive opening occurs.

Table 22. Side Rotary Conveyor Lever, Ceramic Roller

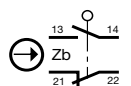
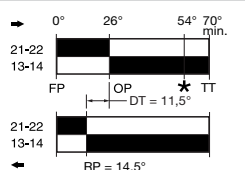
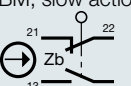
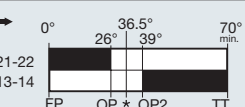
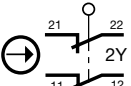
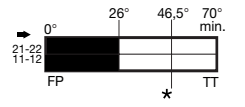
	Contacts	Contact Type	Contact Mtl	Conduit	Oper. Torque	Bar Chart <sup>1</sup>	Listing
	1NC/1NO	Snap action 	Silver	0.5-14 NPT	0,12 Nm max. [1.1 in-lb max.]		GLDA01A9A
			Gold plated	0.5-14 NPT			GLDA07A9A
			Silver	M20			GLDC01A9A
	1NC/1NO	BBM, slow action 	Silver	0.5-14 NPT	0,11 Nm max. [1.0 in-lb max.]		GLDA03A9A
	2NC	Slow action 	Silver	0.5-14 NPT	0,11 Nm max. [1.0 in-lb max.]		GLDA06A9A

<sup>1</sup>Contact closed ■; Contact open □. \*Positive opening occurs.

# GLS Series

## MICRO SWITCH™ GLD SERIES ORDER GUIDE/RECOMMENDED LISTINGS

For listings not shown, contact your Honeywell representative.

Table 23. Side Rotary, 50 mm Rubber Roller

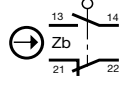
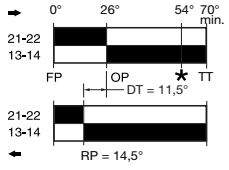
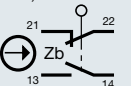
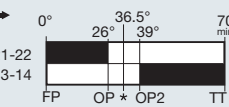
	Contacts	Contact Type	Contact Mtl	Conduit	Oper. Torque	Bar Chart <sup>1</sup>	Listing
	1NC/1NO	Snap action 	Silver	0.5-14 NPT	0,12 Nm max. [1.1 in-lb max.]		GLDA01A1Y
				PG 13,5			GLDB01A1Y
				M20			GLDC01A1Y
	1NC/1NO	BBM, slow action 	Silver	0.5-14 NPT	0,11 Nm max. [1.0 in-lb max.]		GLDA03A1Y
				PG 13,5			GLDB03A1Y

<sup>1</sup>Contact closed ■; Contact open □. \*Positive opening occurs.

Table 24. Side Rotary Adjustable, 50 mm Rubber Roller

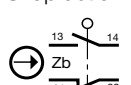
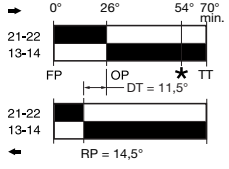
	Contacts	Contact Type	Contact Mtl	Conduit	Oper. Torque	Bar Chart <sup>1</sup>	Listing
	1NC/1NO	Snap action 	Silver	0.5-14 NPT	0,12 Nm max. [1.1 in-lb max.]		GLDA01A2Y
				PG 13,5			GLDB01A2Y
				0.5-14 NPT			0,11 Nm max. [1.0 in-lb max.]
	PG 13,5	GLDB03A2Y					

<sup>1</sup>Contact closed ■; Contact open □. \*Positive opening occurs.

Table 25. Top Pin Plunger

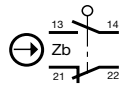
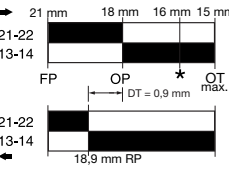
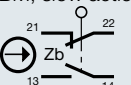
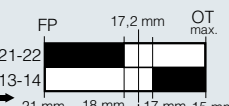
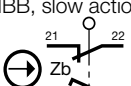
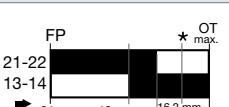
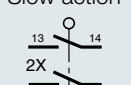
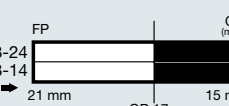
	Contacts	Contact Type	Contact Mtl	Conduit	Oper. Force	Bar Chart <sup>1</sup>	Listing
	1NC/1NO	Snap action 	Silver	0.5-14 NPT	16 N max. [3.6 lb max.]		GLDA01B
			Silver	PG 13,5			GLDB01B
			Gold plated	PG 13,5			GLDB07B
			Silver	M20			GLDC01B
			Gold plated	M20			GLDC07B
	1NC/1NO	BBM, slow action 	Silver	0.5-14NPT	14 N max. [3.2 lb max.]		GLDA03B
				PG 13,5			GLDB03B
	1NC/1NO	MBB, slow action 	Silver	0.5-14 NPT	16 N max. [3.6 lb max.]		GLDA04B
				PG 13,5			GLDB04B
				M20			GLDC04B
2 NO	Slow action 	Silver	M20	13 N max. [2.9 lb max.]		GLDC05B	

<sup>1</sup>Contact closed ■; Contact open □. \*Positive opening occurs. NOTE: Bar chart measurements are in millimeters.



# MICRO SWITCH™ GLS Global Miniature (EN50047 Style) Limit Switches

## MICRO SWITCH™ GLD SERIES ORDER GUIDE/RECOMMENDED LISTINGS

For listings not shown, contact your Honeywell representative.

Table 26. Top Roller Plunger

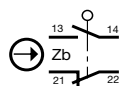
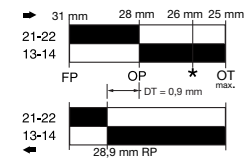
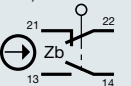
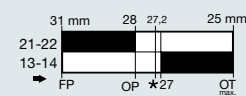
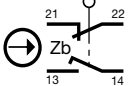
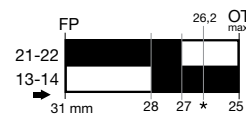
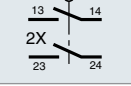
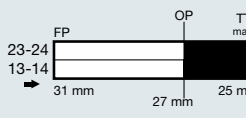
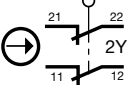
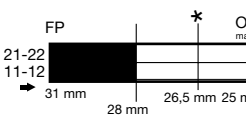
Contacts	Contact Type	Contact Mtl	Conduit	Oper. Force	Bar Chart <sup>1</sup>	Listing
1NC/1NO	Snap action 	Silver	0.5-14 NPT	16 N max. [3.6 lb max.]		GLDA01C
		Gold plated	0.5-14 NPT			GLDA07C
		Silver	PG 13,5			GLDB01C
		Gold plated	PG 13,5			GLDB07C
		Silver	M20			GLDC01C
1NC/1NO	BBM, slow action 	Silver	0.5-14 NPT	14 N max. [3.2 lb max.]		GLDA03C
		Silver	PG 13,5			GLDB03C
		Gold plated	PG 13,5			GLDB33C
		Silver	M20			GLDC03C
1NC/1NO	MBB, slow action 	Silver	PG 13,5	16 N max. [3.6 lb max.]		GLDB04C
2NO	Slow action 	Silver	M20	13 N max. [2.9 lb max.]		GLDC05C
2NC	Slow action 	Silver	0.5-14 NPT	13 N max. [2.9 lb max.]		GLDA06C
		Silver	PG 13,5			GLDB06C
		Gold plated	PG 13,5			GLDB36C
		Silver	M20			GLDC06C

<sup>1</sup>Contact closed ■; Contact open □. \*Positive opening occurs. NOTE: Bar chart measurements are in millimeters.

Table 27. Top Roller Lever

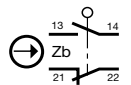
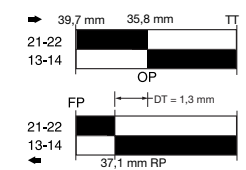
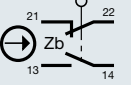
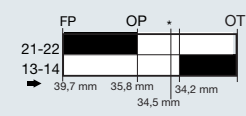
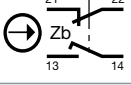
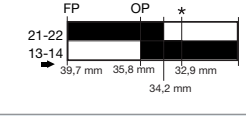
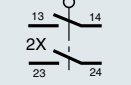
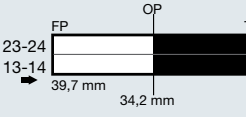
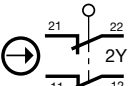
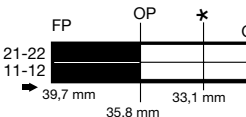
Contacts	Contact Type	Contact Mtl	Conduit	Oper. Force	Bar Chart <sup>1</sup>	Listing
1NC/1NO	Snap action 	Silver	0.5-14 NPT	10 N max. [2.2 lb max.]		GLDA01D
			PG 13,5			GLDB01D
			M20			GLDC01D
1NC/1NO	BBM, slow action 	Silver	0.5-14 NPT	9 N max. [2.0 lb max.]		GLDA03D
			PG 13,5			GLDB03D
			M20			GLDC03D
1NC/1NO	MBB, slow action 	Silver	PG 13,5	10 N max. [2.2 lb max.]		GLDB04D
2NO	Slow action 	Silver	M20	8 N max. [1.8 lb max.]		GLDC05D
2NC	Slow action 	Silver	0.5-14 NPT	8 N max. [1.8 lb max.]		GLDA06D
			M20			GLDC06D





<sup>1</sup>Contact closed ■; Contact open □. \*Positive opening occurs. NOTE: Bar chart measurements are in millimeters.

# GLS Series

## MICRO SWITCH™ GLD SERIES ORDER GUIDE/RECOMMENDED LISTINGS



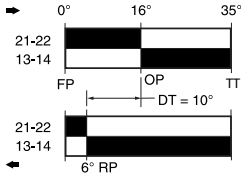

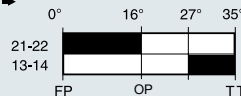
For listings not shown, contact your Honeywell representative.

Table 28. Coil Spring Wobble, 130 mm

	Contacts	Contact Type	Contact Mtl	Conduit	Oper. Force	Bar Chart <sup>1</sup>	Listing
	1NC/1NO	Snap action 	Silver	0.5-14 NPT	1,3 N max. [0.29 lb max.]		GLDA01E7B
				PG 13,5			GLDB01E7B
				M20			GLDC01E7B
	1NC/1NO	BBM, slow action 	Silver	0.5-14 NPT	1,1 N max. [0.25 lb max.]		GLDA03E7B

<sup>1</sup>Contact closed ■; Contact open □.

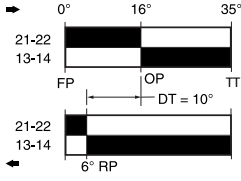
Table 29. Cat Whisker Wobble, 190 mm

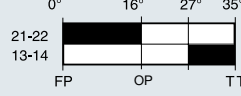
	Contacts	Contact Type	Contact Mtl	Conduit	Oper. Force	Bar Chart <sup>1</sup>	Listing
	1NC/1NO	Snap action 	Silver	0.5-14 NPT	0,9 N max. [0.19 lb max.]		GLDA01K8B
				PG 13,5			GLDB01K8B
				M20			GLDC01K8B
	1NC/1NO	BBM, slow action 	Silver	0.5-14 NPT	0,7 N max. [0.16 lb max.]		GLDA03K8B

<sup>1</sup>Contact closed ■; Contact open □.

# MICRO SWITCH™ GLS Global Miniature (EN50047 Style) Limit Switches

## MICRO SWITCH™ GLD DIMENSIONAL DRAWINGS mm [in]

Figure 12. GLD Side Rotary • A1, A1A, A1B, and A1Y

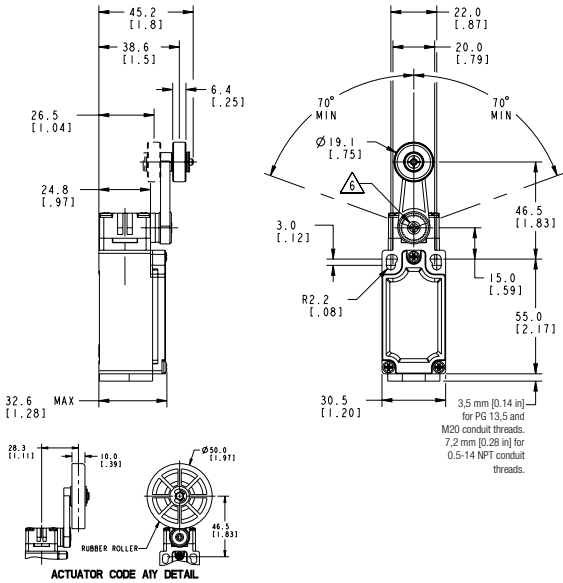

Figure 13. GLD Side Rotary • A2, A2A, A2B, and A2Y

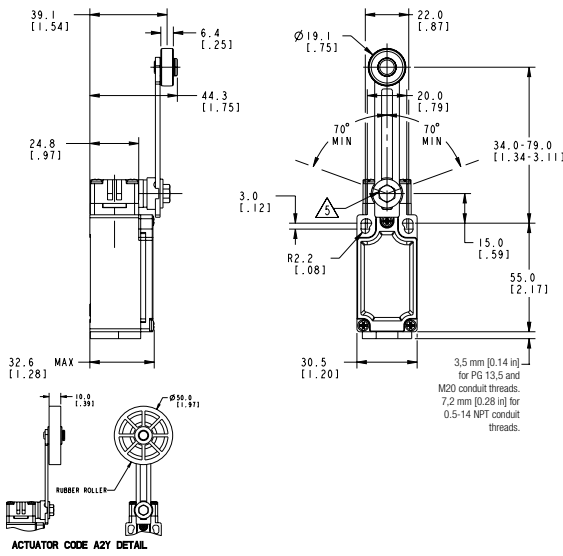

Figure 14. GLD Side Rotary Rod • A4J (140 mm) & A4L (200 mm)

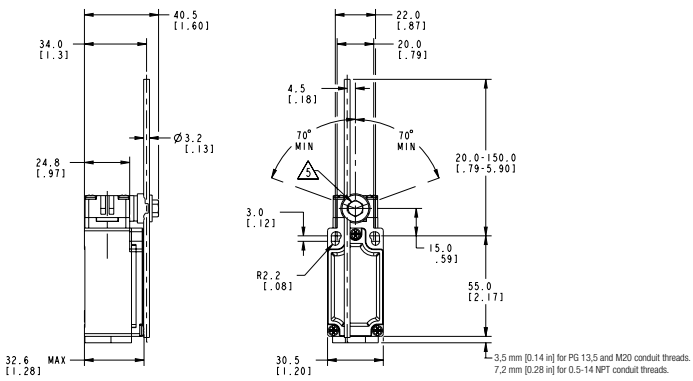

Figure 15. GLD Side Rotary • A5A and A5B

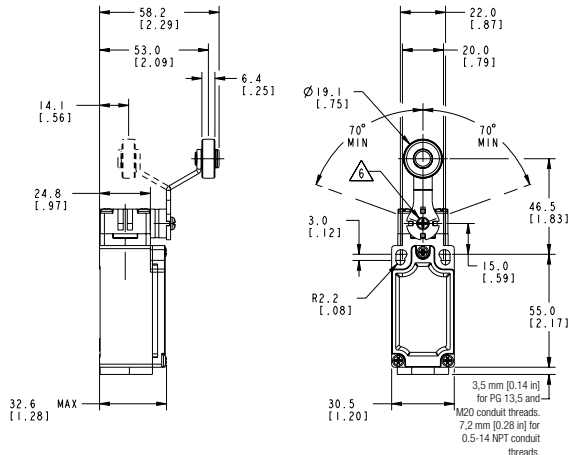

Figure 16. GLD Side Rotary • A9A

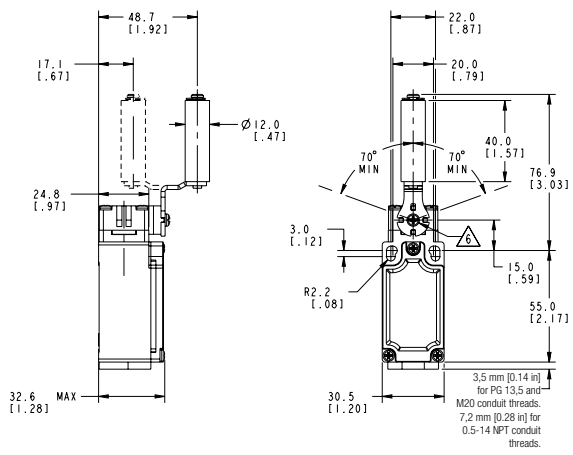
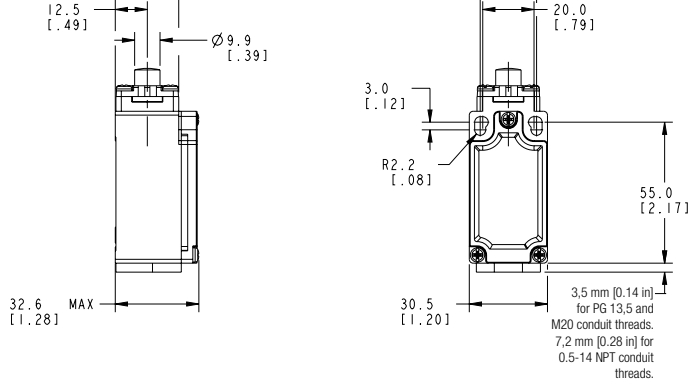

Figure 17. GLD Top Pin Plunger



## MICRO SWITCH™ GLD DIMENSIONAL DRAWINGS mm [in]

Figure 18. GLD Top Roller Plunger

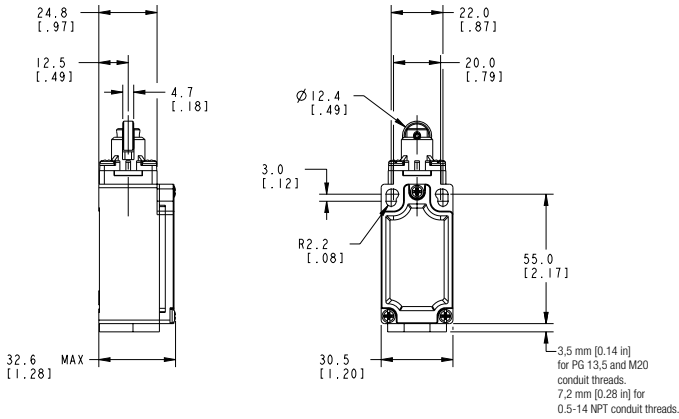

Figure 20. GLD Wobble • E7B

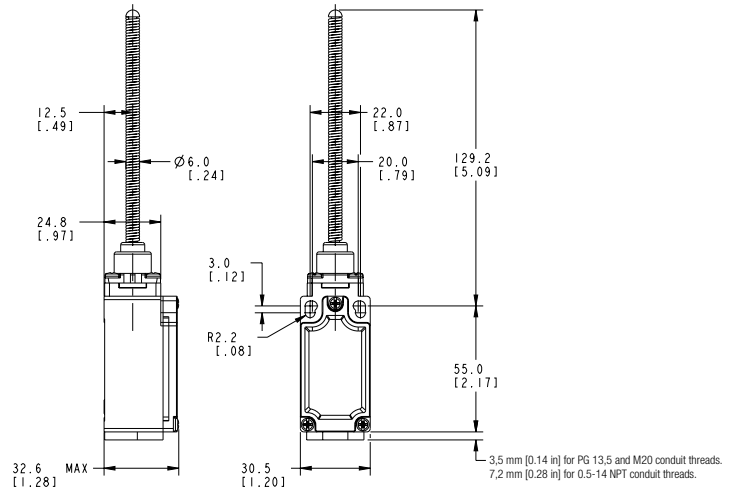

Figure 19. GLD Top Roller Arm

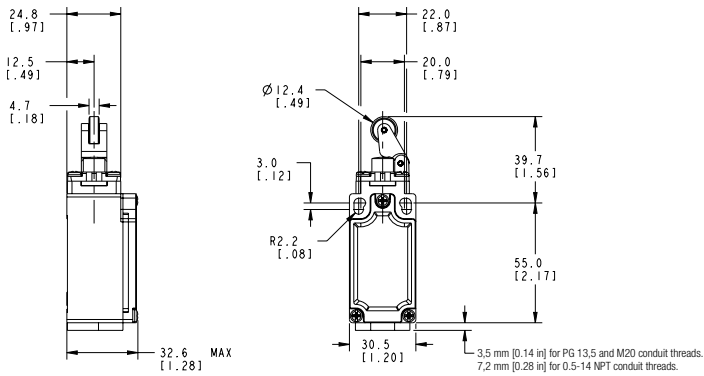

Figure 21. GLD Wobble • K8A/K8B

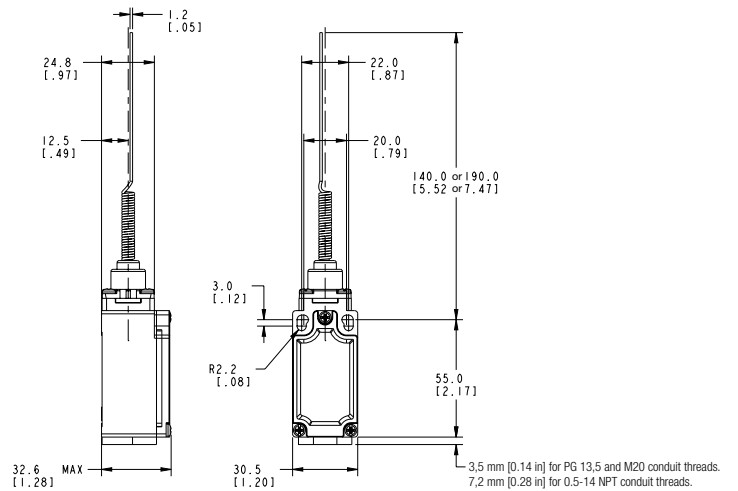
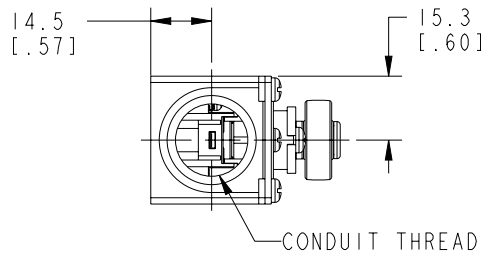

Figure 22. GLD Conduit



# MICRO SWITCH™ GLS Global Miniature (EN50047 Style) Limit Switches

## MICRO SWITCH™ GLE SERIES ORDER GUIDE/RECOMMENDED LISTINGS

For listings not shown, contact your Honeywell representative.

Table 30. Side Rotary, Plastic Roller

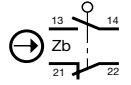
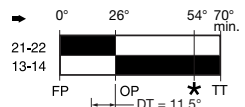
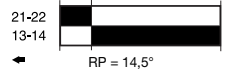
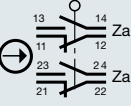
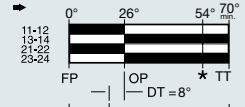
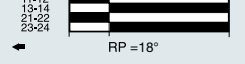
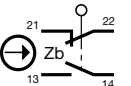
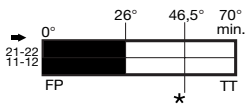
	Contacts	Contact Type	Contact Mtl	Conduit †	Oper. Torque	Bar Chart <sup>1</sup>	Listing
	1NC/1NO	Snap action 	Silver	0.5-14 NPT	0,12 Nm max. [1.1 in-lb max.]		<b>GLEA01A1A</b>
				PG 13,5			<b>GLEB01A1A</b>
	2NC/2NO	Snap action 	Gold plated	0.5-14 NPT	0,165 Nm max. [1.6 in-lb max.]		<b>GLEA32A1A</b>
PG 13,5						<b>GLEB32A1A</b>	
	2NC	Slow action 	Silver	PG 13,5	0,11 Nm max. [1.0 in-lb max.]		<b>GLEB06A1A</b>

<sup>1</sup>Contact closed ■; Contact open □. \*Positive opening occurs. † 0.5-14 NPT conduit option includes adapter.

Table 31. Side Rotary, Metal Roller

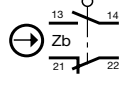
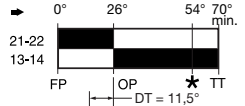
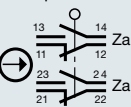
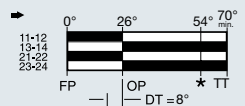
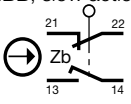
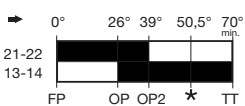
	Contacts	Contact Type	Contact Mtl	Conduit †	Oper. Torque	Bar Chart <sup>1</sup>	Listing
	1NC/1NO	Snap action 	Silver	0.5-14 NPT	0,12 Nm max. [1.1 in-lb max.]		<b>GLEA01A1B</b>
			Silver	PG 13,5			<b>GLEB01A1B</b>
			Gold plated	PG 13,5			<b>GLEB07A1B</b>
			Silver	M20			<b>GLEC01A1B</b>
2NC/2NO	Snap action 	Silver	0.5-14 NPT	0,165 Nm max. [1.6 in-lb max.]		<b>GLEA24A1B</b>	
			PG 13,5			<b>GLEB24A1B</b>	
			M20			<b>GLEC24A1B</b>	
	1NC/1NO	MBB, slow action 	Silver	PG 13,5	0,11 Nm max. [1.0 in-lb max.]		<b>GLEB04A1B</b>

<sup>1</sup>Contact closed ■; Contact open □. \*Positive opening occurs. † 0.5-14 NPT conduit option includes adapter.

## MICRO SWITCH™ GLE SERIES ORDER GUIDE/RECOMMENDED LISTINGS

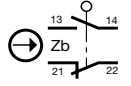
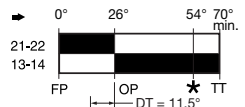
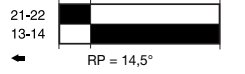
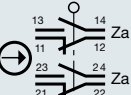
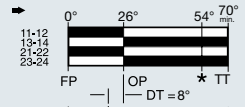
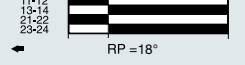

For listings not shown, contact your Honeywell representative.

Table 32. Side Rotary Adjustable, Plastic Roller

	Contacts	Contact Type	Contact Mtl	Conduit †	Oper. Torque	Bar Chart <sup>1</sup>	Listing
	1NC/1NO	Snap action 	Silver	0.5-14 NPT	0,12 Nm max. [1.1 in-lb max.]		GLEA01A2A
				PG 13,5			
	2NC/2NO	Snap action 	Silver	0.5-14 NPT	0,165 Nm max. [1.6 in-lb max.]		GLEA24A2A
				M20			GLEC24A2A

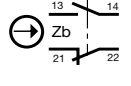
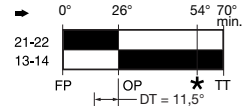
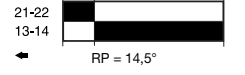
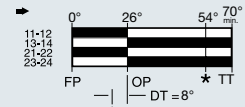

<sup>1</sup>Contact closed ■; Contact open □. \*Positive opening occurs. † 0.5-14 NPT conduit option includes adapter.

Table 33. Side Rotary Adjustable, Metal Roller

	Contacts	Contact Type	Contact Mtl	Conduit †	Oper. Torque	Bar Chart <sup>1</sup>	Listing
	1NC/1NO	Snap action 	Silver	0.5-14 NPT	0,12 Nm max. [1.1 in-lb max.]		GLEA01A2B
				PG 13,5			GLEB01A2B
				M20			GLEC01A2B
	2NC/2NO	Snap action 	Gold plated	PG 13,5	0,165 Nm max. [1.6 in-lb max.]		GLEB07A2B
0.5-14 NPT				Silver			0.5-14 NPT
				PG 13,5			GLEB24A2B

<sup>1</sup>Contact closed ■; Contact open □. \*Positive opening occurs. † 0.5-14 NPT conduit option includes adapter.

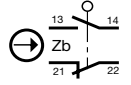
Table 34. Side Rotary Adjustable, Metal Rod, A4J (140 mm Rod)

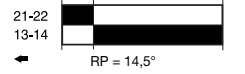
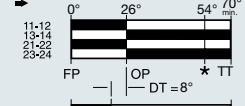
	Contacts	Contact Type	Contact Mtl	Conduit †	Oper. Torque	Bar Chart <sup>1</sup>	Listing
	1NC/1NO	Snap action 	Silver	0.5-14 NPT	0,12 Nm max. [1.1 in-lb max.]		GLEA01A4J
				PG 13,5			GLEB01A4J
				M20			GLEC01A4J
	2NC/2NO	Snap action 	Silver	0.5-14 NPT	0,165 Nm max. [1.6 in-lb max.]		GLEA24A4J

<sup>1</sup>Contact closed ■; Contact open □. \*Positive opening occurs. † 0.5-14 NPT conduit option includes adapter.

# MICRO SWITCH™ GLS Global Miniature (EN50047 Style) Limit Switches

## MICRO SWITCH™ GLE SERIES ORDER GUIDE/RECOMMENDED LISTINGS

For listings not shown, contact your Honeywell representative.

Table 35. Side Rotary Offset Lever, Plastic Roller

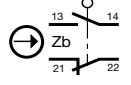
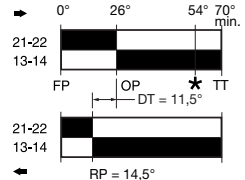
	Contacts	Contact Type	Contact Mtl	Conduit †	Oper. Torque	Bar Chart <sup>1</sup>	Listing
	1NC/1NO	Snap action 	Silver	0.5-14 NPT	0,12 Nm max. [1.1 in-lb max.]		<b>GLEA01A5A</b> <b>GLEB01A5A</b>
				PG 13,5			

<sup>1</sup>Contact closed ■; Contact open □. \*Positive opening occurs. † 0.5-14 NPT conduit option includes adapter.

Table 36. Side Rotary Offset Lever, Metal Roller

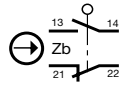
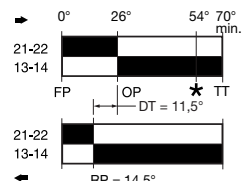
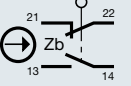
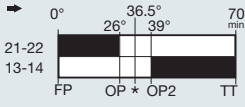
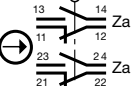
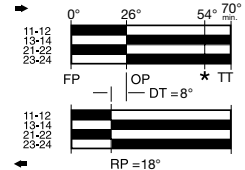
	Contacts	Contact Type	Contact Mtl	Conduit †	Oper. Torque	Bar Chart <sup>1</sup>	Listing
	1NC/1NO	Snap action 	Silver	0.5-14 NPT	0,12 Nm max. [1.1 in-lb max.]		<b>GLEA01A5B</b> <b>GLEB01A5B</b>
				PG 13,5			
	1NC/1NO	BBM, slow action 	Silver	PG 13,5	0,11 Nm max. [1.0 in-lb max.]		<b>GLEB03A5B</b>
	2NC/2NO	Snap action 	Silver	0.5-14 NPT	0,165 Nm max. [1.6 in-lb max.]		<b>GLEA24A5B</b>

<sup>1</sup>Contact closed ■; Contact open □. \*Positive opening occurs. † 0.5-14 NPT conduit option includes adapter.

Table 37. Side Rotary Conveyor Lever, Ceramic Roller

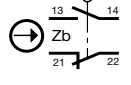
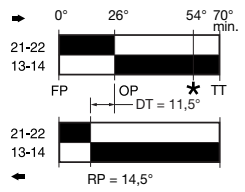
	Contacts	Contact Type	Contact Mtl	Conduit	Oper. Torque	Bar Chart <sup>1</sup>	Listing
	1NC/1NO	Snap action 	Silver	PG 13,5	0,12 Nm max. [1.1 in-lb max.]		<b>GLEB01A9A</b> <b>GLEC01A9A</b>
				M20			

<sup>1</sup>Contact closed ■; Contact open □. \*Positive opening occurs.

# GLS Series

## MICRO SWITCH™ GLE SERIES ORDER GUIDE/RECOMMENDED LISTINGS

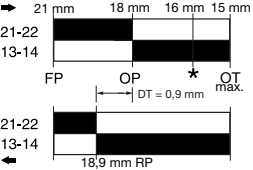
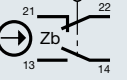
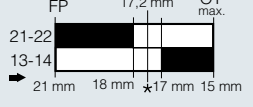
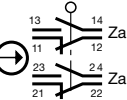
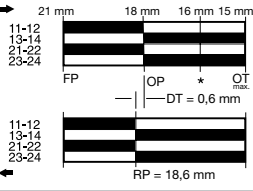

For listings not shown, contact your Honeywell representative.

Table 38. Top Pin Plunger

	Contacts	Contact Type	Contact Mtl	Conduit †	Oper. Force	Bar Chart <sup>1</sup>	Listing					
	1NC/1NO	Snap action 	Silver	0.5-14 NPT	16 N max. [3.6 lb max.]		GLEA01B					
				PG 13,5			GLEB01B					
				M20			GLEC01B					
			Gold plated	PG 13,5			GLEB07B					
				1NC/1NO			BBM, slow action 	Silver	PG 13,5	14 N max. [3.2 lb max.]		GLEB03B
									M20			GLEC03B
	Gold plated	PG 13,5	GLEB33B									
		M20	GLEC33B									
	2NC/2NO	Snap action 	Silver	0.5-14 NPT	13 N max. [2.9 lb max.]		GLEA24B					
				PG 13,5			GLEB24B					
				M20			GLEC24B					
			Gold plated	M20			GLEC32B					

<sup>1</sup>Contact closed ■; Contact open □. \*Positive opening occurs. NOTE: Bar chart measurements are in millimeters. † 0.5-14 NPT conduit option includes adapter.

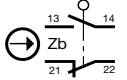
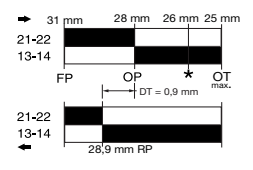
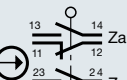
Table 39. Top Roller Plunger

	Contacts	Contact Type	Contact Mtl	Conduit †	Oper. Force	Bar Chart <sup>1</sup>	Listing				
	1NC/1NO	Snap action 	Silver	0.5-14 NPT	16 N max. [3.6 lb max.]		GLEA01C				
				PG 13,5			GLEB01C				
				M20			GLEC01C				
	Gold plated		PG 13,5	GLEB07C							
			2NC/2NO	Snap action 			Silver	0.5-14 NPT	13 N max. [2.9 lb max.]		GLEA24C
								PG 13,5			GLEB24C
M20	GLEC24C										

<sup>1</sup>Contact closed ■; Contact open □. \*Positive opening occurs. NOTE: Bar chart measurements are in millimeters. † 0.5-14 NPT conduit option includes adapter.



# MICRO SWITCH™ GLS Global Miniature (EN50047 Style) Limit Switches

## MICRO SWITCH™ GLE SERIES ORDER GUIDE/RECOMMENDED LISTINGS

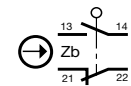
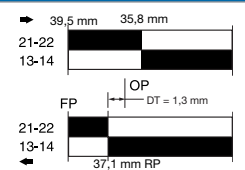
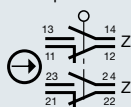
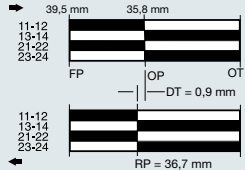
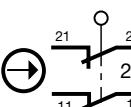
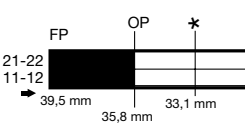

For listings not shown, contact your Honeywell representative.

Table 40. Top Roller Lever

	Contacts	Contact Type	Contact Mtl	Conduit †	Oper. Force	Bar Chart <sup>1</sup>	Listing
	1NC/1NO	Snap action 	Silver	0.5-14 NPT	10 N max. [2.2 lb max.]		GLEA01D
				PG 13,5			GLEB01D
				M20			GLEC01D
	2NC/2NO	Snap action 	Silver	0.5-14 NPT	3,2 N max. [0.72 lb max.]		GLEA24D
				PG 13,5			GLEB24D
				M20			GLEC24D
2 NC	Slow action 	Silver	0.5-14 NPT	8 N max. [1.8 lb max.]		GLEA06D	

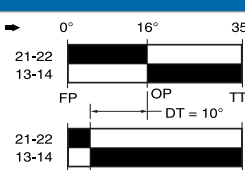
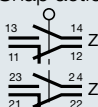
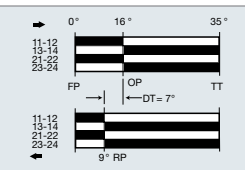

<sup>1</sup>Contact closed ■; Contact open □. \*Positive opening occurs. NOTE: Bar chart measurements are in millimeters. † 0.5-14 NPT conduit option includes adapter.

Table 41. Coil Spring Wobble, 130 mm

	Contacts	Contact Type	Contact Mtl	Conduit †	Oper. Force	Bar Chart <sup>1</sup>	Listing
	1NC/1NO	Snap action 	Silver	0.5-14 NPT	1,3 N max. [0.29 lb max.]		GLEA01E7B
				PG 13,5			GLEB01E7B
	2NC/2NO	Snap action 	Silver	0.5-14 NPT	1.1 N max. 0.25 lb max.]		GLEA24E7B
				PG 13,5			GLEB24E7B

<sup>1</sup>Contact closed ■; Contact open □. \*Positive opening occurs. NOTE: Bar chart measurements are in millimeters. † 0.5-14 NPT conduit option includes adapter.

Table 42. Cat Whisker Wobble, 140 mm

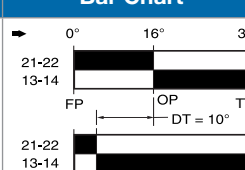
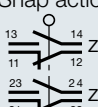
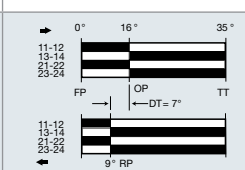
	Contacts	Contact Type	Contact Mtl	Conduit	Oper. Force	Bar Chart <sup>1</sup>	Listing
	1NC/1NO	Snap action 	Silver	PG 13,5	0,9 N max. [0.19 lb max.]		GLEB01K8A
			Gold plated	PG 13,5			GLEB07K8A
	2NC/2NO	Snap action 	Silver	PG 13,5	1.1 N max. 0.25 lb max.]		GLEB24K8A

<sup>1</sup>Contact closed ■; Contact open □.

## MICRO SWITCH™ GLE DIMENSIONAL DRAWINGS mm [in]

Figure 23. GLE Side Rotary • A1, A1A, A1B, and A1Y

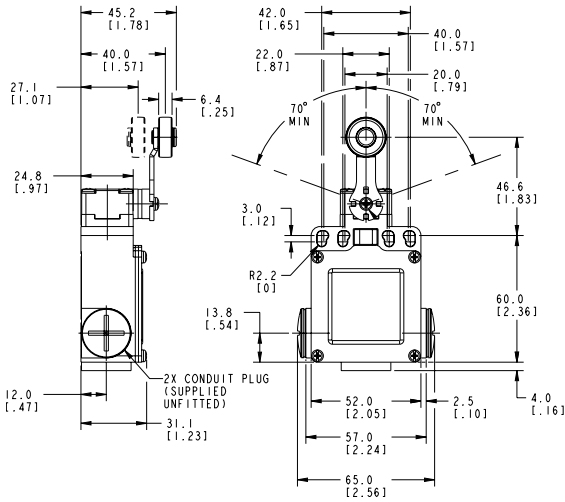

Figure 26. GLE Side Rotary • A5A and A5B

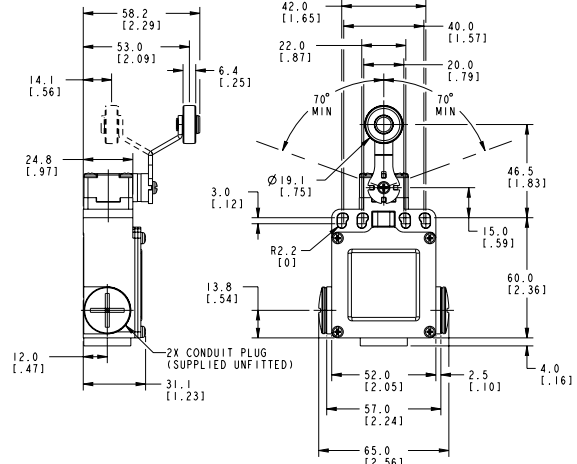

Figure 24. GLE Side Rotary • A2, A2A, A2B, and A2Y

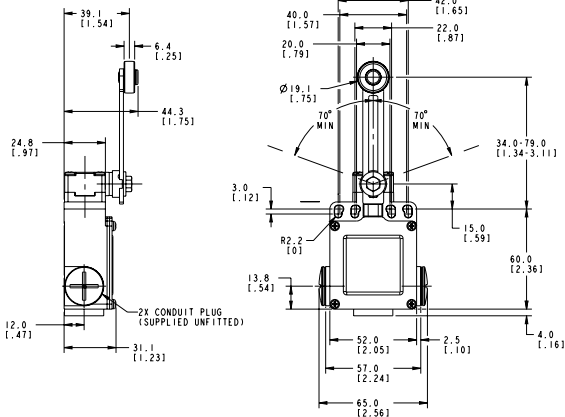

Figure 27. GLE Side Rotary • A9A

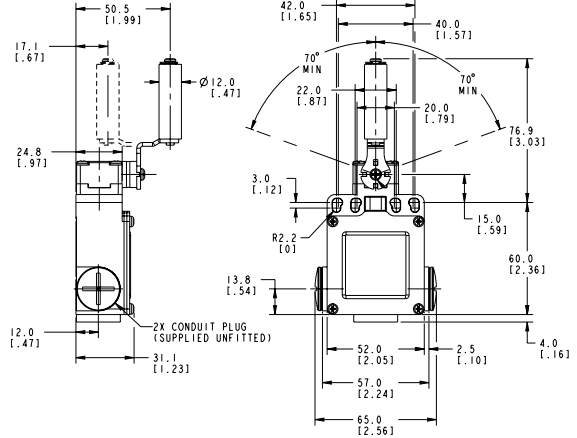

Figure 25. GLE Side Rotary • A4J and A4L

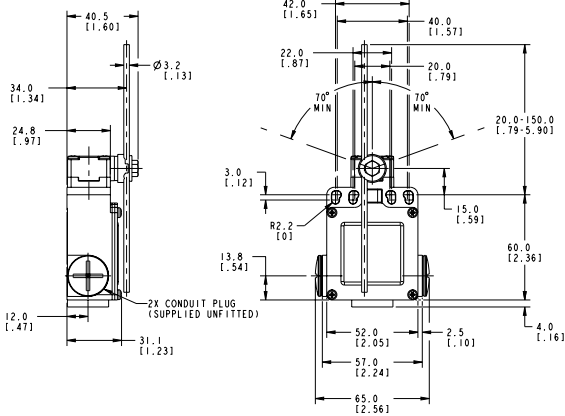
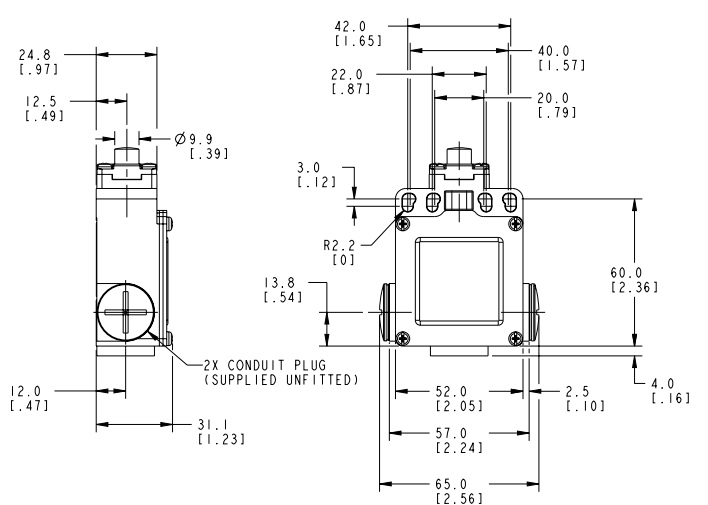

Figure 28. GLE Top Pin Plunger



# MICRO SWITCH™ GLS Global Miniature (EN50047 Style) Limit Switches

## MICRO SWITCH™ GLE DIMENSIONAL DRAWINGS mm [in]

Figure 29. GLE Top Roller Plunger

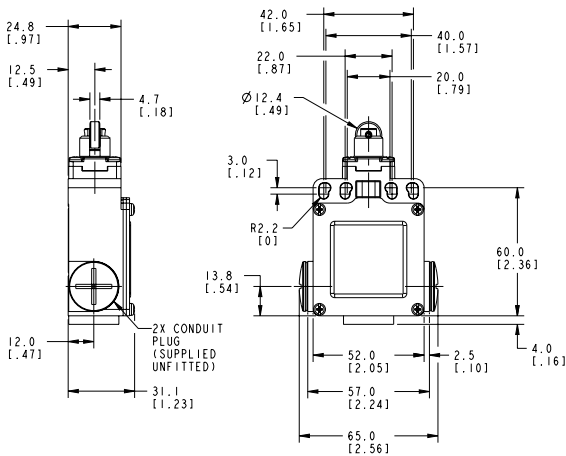

Figure 31. GLE Wobble • E7B

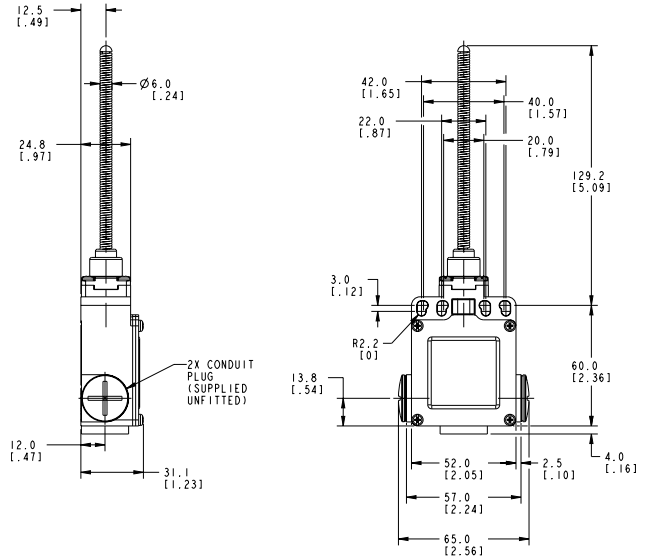

Figure 30. GLE Top Roller Arm

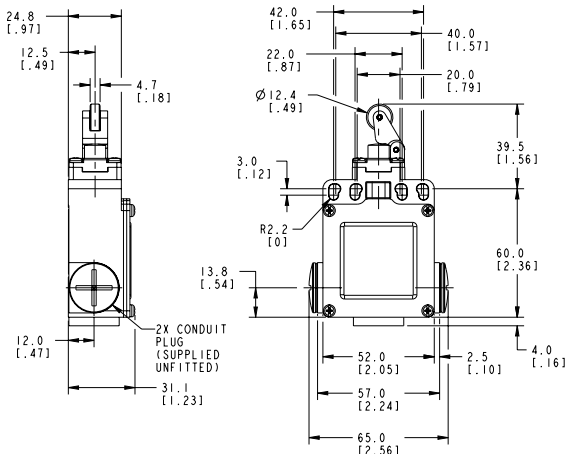

Figure 32. GLE Wobble • K8A

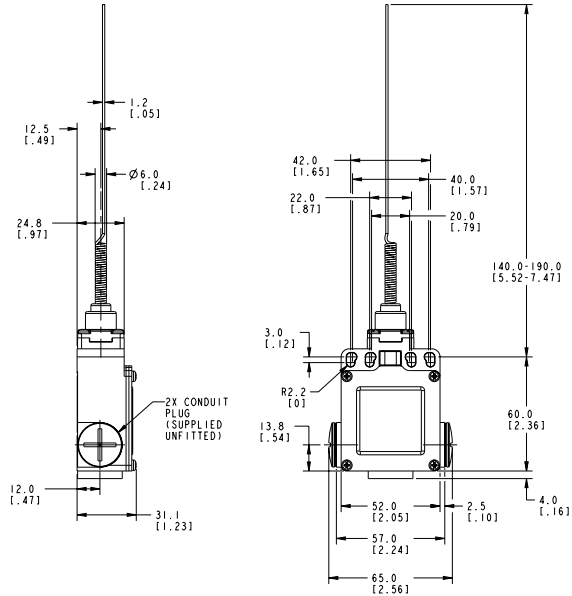
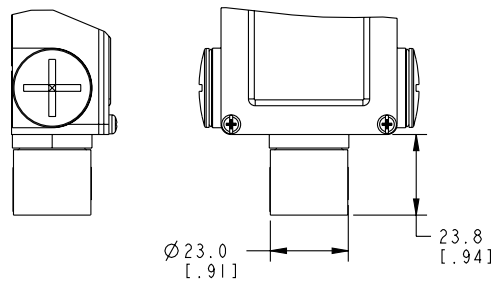

Figure 33. GLE Conduit Adapter for 0.5-14 NPT



# GLS Series

## FACTORY PRE-WIRED LIMIT SWITCHES WITH INTEGRAL CONNECTOR

### Epoxy coated metal Limit Switches

**GLCC01B-D1:** Top pin plunger, 1NC/1NO snap action, with Deutsch DT style 4 pin connector

**GLCC01C-D1:** Top roller plunger, 1NC/1NO snap action, with Deutsch DT style 4 pin connector

**GLCC06A1B-D1:** Side rotary with metal roller, 2NC slow action, with Deutsch DT style 4 pin connector



### Plastic Limit Switches

**GLDC01A1A-D1:** Side rotary with plastic roller, 1NC/1NO snap action, with Deutsch DT style 4 pin connector

**GLDC01A1B-D1:** Side rotary with metal roller, 1NC/1NO snap action, with Deutsch DT style 4 pin connector

**GLDC01C-D1:** Top roller plunger, 1NC/1NO snap action, with Deutsch DT style 4 pin connector

Note: Reference base catalog listing for switch characteristics. For example, cat. listing GLCC01B-D1 has base cat. listing GLCC01B.

### Connector Without Limit Switch



**GLZ8C-DEU:** DT style 4 pin connector prewired with 6 in. of lead wires (4) and 20 mm conduit thread with jam nut



**GLZ8C-PA:** DT style 4 pin connector packet with all parts furnished unassembled for a 20 mm conduit thread

## FACTORY PRE-WIRED LIMIT SWITCHES WITH INTEGRAL CONNECTOR

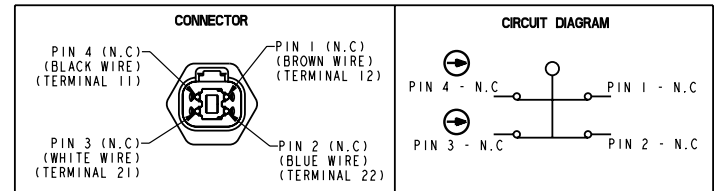
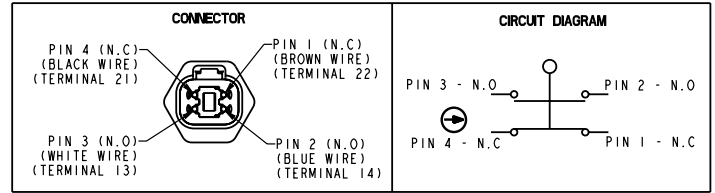

## REPLACEMENT PARTS - BASIC SWITCHES

Body Type	Basic Switch									
	01	03	04	06	07	24	32	33	34	36
GLC	GLZ301	GLZ303	GLZ304	GLZ306	GLZ307	n/a	n/a	GLZ333	GLZ334	GLZ336
GLD	GLZ301	GLZ303	GLZ304	GLZ306	GLZ307	n/a	n/a	GLZ333	GLZ334	GLZ336
GLE	GLZ301	GLZ303	GLZ304	GLZ306	GLZ307	GLZ324	GLZ332	GLZ333	GLZ334	GLZ336

# MICRO SWITCH™ GLS Global Miniature (EN50047 Style) Limit Switches

This datasheet supports the following MICRO SWITCH™ GLS Series Limit Switches

GLCA01A1A	GLCB01B	GLCC03A2B	GLDA06A9A	GLDB07A2A	GLEA01A1B	GLEB07C
GLCA01A1B	GLCB01C	GLCC06A1B-D1	GLDA06C	GLDB07A2B	GLEA01A2A	GLEB07K8A
GLCA01A1B-3	GLCB01D	GLCC06C	GLDA06D	GLDB07B	GLEA01A2B	GLEB24A1B
GLCA01A2A	GLCB01E7B	GLCC06D	GLDA07A2B	GLDB07C	GLEA01A4J	GLEB24A2B
GLCA01A2B	GLCB01K8A	GLCC07A1A	GLDA07A9A	GLDB33C	GLEA01A5A	GLEB24B
GLCA01A4J	GLCB01K8B	GLCC07A1B	GLDA07C	GLDB33C-6	GLEA01A5B	GLEB24C
GLCA01A5B	GLCB03A1B	GLCC07A2B	GLDB01A1-3	GLDB36A5B	GLEA01B	GLEB24C-6
GLCA01A9A	GLCB03A2A	GLCD03A1A	GLDB01A1A	GLDB36C	GLEA01C	GLEB24C-6
GLCA01B	GLCB03B	GLCD03B	GLDB01A1B	GLDB36C-6	GLEA01D	GLEB24E7B
GLCA01C	GLCB03C	GLDA01A1A	GLDB01A1B3	GLDC01A1A	GLEA01E7B	GLEB24K8A
GLCA01C-6	GLCB03D	GLDA01A1A-D	GLDB01A1Y	GLDC01A1A-D1	GLEA06D	GLEB32A1A
GLCA01D	GLCB04A1B	GLDA01A1B	GLDB01A2	GLDC01A1B	GLEA24A1B	GLEB33B
GLCA01E7B	GLCB04B	GLDA01A1B-D	GLDB01A2A	GLDC01A1B-D1	GLEA24A1B-C	GLEC01A1B
GLCA01K8A	GLCB04C	GLDA01A1Y	GLDB01A2B	GLDC01A1Y	GLEA24A2A	GLEC01A2B
GLCA01K8B	GLCB04D	GLDA01A2A	GLDB01A2Y	GLDC01A2A	GLEA24A2B	GLEC01A4J
GLCA03A1A	GLCB06A1B	GLDA01A2B	GLDB01A4J	GLDC01A2B	GLEA24A4J	GLEC01A9A
GLCA03A1B	GLCB06A1B-3	GLDA01A2Y	GLDB01A5B	GLDC01A4J	GLEA24A5B	GLEC01B
GLCA03B	GLCB06A1B-4	GLDA01A4J	GLDB01B	GLDC01A5B	GLEA24B	GLEC01C
GLCA03C	GLCB06A2B	GLDA01A5B	GLDB01C	GLDC01A9A	GLEA24C	GLEC01D
GLCA03C-6	GLCB06B	GLDA01A9A	GLDB01D	GLDC01B	GLEA24C-6	GLEC03B
GLCA03D	GLCB06C	GLDA01B	GLDB01D-D	GLDC01C	GLEA24D	GLEC24A1B
GLCA03E7B	GLCB07A1B	GLDA01C	GLDB01E7B	GLDC01C-D1	GLEA24E7B	GLEC24A2A
GLCA03K8B	GLCB07A1B-3	GLDA01C-D	GLDB01K8B	GLDC01D	GLEA32A1A	GLEC24B
GLCA04A1B	GLCB07A2B	GLDA01D	GLDB03A1A	GLDC01E7B	GLEB01A1A	GLEC24C
GLCA04A2B	GLCB07B	GLDA01E7B	GLDB03A1B	GLDC01K8B	GLEB01A1B	GLEC24D
GLCA04B	GLCB07C	GLDA01K8B	GLDB03A1Y	GLDC03A4J	GLEB01A2A	GLEC32B
GLCA05A1A	GLCB07D	GLDA03A1A	GLDB03A1Y-3	GLDC03C	GLEB01A2B	GLEC33B
GLCA06A1B-4	GLCB07E7B	GLDA03A1B	GLDB03A1Y-4	GLDC03D	GLEB01A4J	GLED01D
GLCA06A5B	GLCB33D	GLDA03A1Y	GLDB03A2A	GLDC04B	GLEB01A5A	GLZ301
GLCA06C-6	GLCB34A1B-5	GLDA03A2Y	GLDB03A2Y	GLDC05A1A	GLEB01A5B	GLZ303
GLCA06E7B	GLCB35A1B-5	GLDA03A9A	GLDB03B	GLDC05A2A	GLEB01A9A	GLZ304
GLCA07A1B-3	GLCB36C	GLDA03B	GLDB03C	GLDC05B	GLEB01B	GLZ306
GLCA36A5B	GLCC01A1A	GLDA03C	GLDB03C-6	GLDC05C	GLEB01C	GLZ307
GLCA36D	GLCC01A1B	GLDA03C-6	GLDB03D	GLDC05D	GLEB01D	GLZ332
GLCB01A1A	GLCC01A2B	GLDA03D	GLDB04A1A	GLDC06A1A	GLEB01E7B	GLZ333
GLCB01A1A/4	GLCC01A4J	GLDA03E7B	GLDB04B	GLDC06A1B	GLEB01K8A	GLZ334
GLCB01A1B	GLCC01A9A	GLDA03K8B	GLDB04C	GLDC06C	GLEB03A5B	GLZ336
GLCB01A2A	GLCC01B	GLDA04A2B	GLDB04D	GLDC06D	GLEB03B	GLZ8C-DEU
GLCB01A2B	GLCC01B-D1	GLDA04A4J	GLDB06A1B	GLDC07A1B	GLEB04A1B	GLZ8C-PA
GLCB01A4J	GLCC01C	GLDA04B	GLDB06A2A	GLDC07B	GLEB06A1A	
GLCB01A4L	GLCC01C-D1	GLDA05A2B	GLDB06C	GLDD01A1B	GLEB07A1B	
GLCB01A5B	GLCC01D	GLDA06A1B	GLDB07A1A	GLDD01D	GLEB07A2B	
GLCB01A9A	GLCC01E7B	GLDA06A2A	GLDB07A1B	GLEA01A1A	GLEB07B	

## ADDITIONAL INFORMATION

The following associated literature is available on the Honeywell web site at [sensing.honeywell.com](http://sensing.honeywell.com):

- Product installation instructions
- Aerospace range guide
- Transportation range guide
- Limits and Machine Safety range guide
- Product application-specific information
  - Application Note: Sensors and Switches for Industrial Manual Process Valves
  - Application Note: Sensors and Switches Used in Valve Actuators and Valve Positioners
  - Industrial Machinery Switch Guide
  - Limit and Enclosed Switches Application Information
  - Limit and Enclosed Switches Operating Characteristics
  - Limit and Enclosed Switches Reference Standards
  - Limit and Enclosed Switches Typical Applications
  - Sensors and Switches in Mobile Cranes
  - Sensors and Switches in Front Loaders
  - Sensors and Switches in Elevator Applications

### **WARNING**

#### **IF USED IN APPLICATIONS CONCERNING HUMAN SAFETY**

- Only use NC direct opening (“positive opening”/“positive break”) contacts, identified by the symbol .
- Do NOT use flexible/adjustable actuators. Only use actuators designed for safety applications.
- Do NOT defeat, tamper, remove, or bypass this switch.
- Hazardous voltage, disconnect power before servicing.
- Strictly adhere to all installation and maintenance instructions
- Consult with local safety agencies and their requirements when designing a machine-control link, interface, and all control elements that affect safety.

**Failure to comply with these instructions could result in death or serious injury.**

### **WARNING**

#### **MISUSE OF DOCUMENTATION**

- The information presented in this product sheet is for reference only. Do not use this document as a product installation guide.
- Complete installation, operation, and maintenance information is provided in the instructions supplied with each product.

**Failure to comply with these instructions could result in death or serious injury.**

## WARRANTY/REMEDY

Honeywell warrants goods of its manufacture as being free of defective materials and faulty workmanship. Honeywell’s standard product warranty applies unless agreed to otherwise by Honeywell in writing; please refer to your order acknowledgement or consult your local sales office for specific warranty details. If warranted goods are returned to Honeywell during the period of coverage, Honeywell will repair or replace, at its option, without charge those items it finds defective. **The foregoing is buyer’s sole remedy and is in lieu of all other warranties, expressed or implied, including those of merchantability and fitness for a particular purpose. In no event shall Honeywell be liable for consequential, special, or indirect damages.**

While we provide application assistance personally, through our literature and the Honeywell website, it is up to the customer to determine the suitability of the product in the application.

Specifications may change without notice. The information we supply is believed to be accurate and reliable as of this printing. However, we assume no responsibility for its use.

**Find out more**

Honeywell serves its customers through a worldwide network of sales offices, representatives and distributors. For application assistance, current specifications, pricing or name of the nearest Authorized Distributor, contact your local sales office.

To learn more about Honeywell's sensing and control products, call **+1-815-235-6847** or **1-800-537-6945**, visit **sensing.honeywell.com**, or e-mail inquiries to **info.sc@honeywell.com**

Sensing and Control  
Honeywell  
1985 Douglas Drive North  
Golden Valley, MN 55422  
**honeywell.com**

The Honeywell logo is displayed in a bold, red, sans-serif font.