

## Precision Thermostats



### DESCRIPTION

Thermostats can provide either temperature control or over-temperature protection by breaking electrical contact when a specified temperature is reached.

Honeywell manufactures a wide range of thermostats for a variety of potential applications:

- Non-hermetic and hermetically-sealed versions designed to serve infotech, transportation, telecom, industrial, aircraft, medical equipment, radar, communications and electronic control systems needs.
- High reliability military and aerospace versions that meet the unique needs of the military, aerospace and aviation industries.

Honeywell can also integrate these thermostats in higher value cable assemblies, incorporating wire harness and connectors.

Also available are a selection of pre-configured REDI-TEMP Thermostats.

### Table of Contents

<b>DESCRIPTION</b>	<b>p. 1</b>
<b>NOMENCLATURE</b>	<b>p. 2</b>
<b>DEFINITION OF TERMS</b>	<b>p. 3</b>
<b>NOTES</b>	
<b>PRECISION THERMOSTATS</b>	
3600/3601 Series TO-5 Thermal Switches	<b>p. 4</b>
3001/3004 Series Non-Hermetic	<b>p. 6</b>
3150 Series Low Profile Hermetic	<b>p. 8</b>
3156 Series Low Level/Low Profile Hermetic	<b>p. 10</b>
3100 Series Hermetic	<b>p. 12</b>
3106 Series Low Level Hermetic	<b>p. 14</b>
3800 Series Industrial Grade for Severe Duty	<b>p. 16</b>
3000 Series Custom (345X Series Internal)	<b>p. 18</b>
<b>HIGH RELIABILITY MILITARY AND AEROSPACE THERMOSTATS</b>	
3153 Series Low Profile	<b>p. 21</b>
3500 Series Military	<b>p. 22</b>
3000 Series Custom (3500 Series/Other Internal)	<b>p. 24</b>
3MS1 QPL Series Military	<b>p. 25</b>
3200 Series High Reliability	<b>p. 27</b>
<b>MOUNTING HARDWARE</b>	<b>p. 29</b>
Brackets, studs and terminations	
<b>REDI-TEMP THERMOSTATS</b>	
3100U REDI-TEMP Series	<b>p. 34</b>
3600/3601 REDI-TEMP Series	<b>p. 35</b>

# Precision Thermostats

## NOMENCLATURE

The nomenclature given in Figures 1 and 2 is provided for reference only.

Figure 1. Precision Thermostat Nomenclature



Figure 2. High Reliability Military and Aerospace Thermostat Nomenclature



## DEFINITION OF TERMS

- **Automatic Reset:** A type of thermostat that will automatically reset at a specific temperature (i.e. a thermostat operates at 65,5 °C [150 °F] and resets at 48,89 °C [120 °F]).
- **Bimetal:** Two dissimilar metals bonded together to form the material for manufacturing thermally-sensitive discs which actuate the thermostat.
- **Close on Rise (COR):** Refers to operation of the contacts. When the temperature rises to its set point, the contacts close or make contact and complete the circuit.
- **Contact Resistance:** The value of resistance measured between the terminals.
- **Dielectric Strength:** The value of insulation between two electrically conducting parts. It may be tested by the application of a predetermined overvoltage for a specified time.
- **Differential:** The temperature difference between the operate and reset set points, also known as operate and reset.
  - **Nominal:** The temperature difference between nominal set points regardless of tolerance.
  - **Maximum:** The temperature difference between the operate and reset points.
  - **Minimum:** Minimum number of degrees between actual open and closing set points.
- **Exposure Temperature:** Thermal environment of a device during application operation.
- **FLA (Full Load Amps):** Current taken from the line by the motor when the motor is yielding the rated hp at the rated voltage and frequency.
- **Life Cycles:** The endurance rating of the thermostat expressed in number of operations with stated electrical load applied. Temperature limit application = open or rise.
- **LRA (Locked Rotor Amps):** The amount of current the motor can be expected to draw under starting conditions when full voltage is applied, also known as starting inrush current.
- **Manual Reset:** A bimetal thermostat with a reset button that must be pressed to reset the contacts.
- **Open on Rise (OOR):** Refers to the operation of contacts. When the temperature rises to its set point the contacts open, terminating the circuit.
- **Overmold:** Encapsulation with an insulating material.
- **Phenolic:** Thermoset plastic used for the insulating body of the thermostat.
- **Set Point:** The nominal temperature at which the thermostat operates.
- **SPST (Single Pole/Single Throw):** A switch with one current path which can be either open or closed.
- **Tolerance:** The allowable range above and below the set point temperature.
- **Operate:** Change of state when the thermostat reaches its set point.
- **Reset:** Change of state when the thermostat returns to its original condition prior to operation.

## NOTES

- **Standard Temperature Characteristics Tables:**
  - **Temperatures:** Please consult applications engineering for temperature ranges, tolerances and differentials not noted. The operating temperature ranges include tolerances.
  - **Tolerances:** The  $\pm$  tolerances given have been established after review of many thermostat applications. Attempts should be made to establish the widest acceptable tolerance possible.
- **UL and CSA Approvals:** 12,7 mm [0.5 in] thermostats are available with multiple agency approval for incorporation into equipment.
- **Fan control applications:** Require thermostat set points to be derated by 20 °C from the equivalent temperature limit application. They also close on rise.

# Precision Thermostats

Figure 3. 3600/3601 Series TO-5 Thermal Switches



The 3600/3601 Series is a single-pole, single-throw, bimetal snap-action switch that opens (3600) or closes (3601) on temperature rise. This series represents the first hermetically sealed switches in a TO-5 package that is wave solderable, providing increased manufacturing efficiency. They are designed for mounting on printed circuit boards to protect against hazardous temperatures associated with the thermal density of components on backplanes, flexible circuitry and sophisticated time-based circuits. They have WE-1 gold alloy cross point contacts for low voltage applications, and are packaged in a standard JEDEC TO-5 transistor housing with 19 mm [0.75 in] long, 457 mm [0.018 in] diameter leads. They provide both ambient and surface sensing and are preset and tamper-proof. A variety of mounting brackets is available.

Preconfigured REDI-TEMP versions are available. See page 35.

Potential applications:

- Printed circuit boards
- Logic level or dry circuit applications

Table 1. 3600/3601 Series Standard Temperature Characteristics\*

Series	Operating Temperature Range	Contact Action	Set Point Tolerance
3600	40 °C to 120 °C [104 °F to 248 °F]	open on rise	±5 °C [±8 °F]
3601	40 °C to 120 °C [104 °F to 248 °F]	close on rise	±7 °C [±12.6 °F]

\*Operating temperatures are available in 5 °C [8 °F] increments between 40 °C to 120 °C [104 °F to 248 °F].

**Table 2. 3600/3601 Series Specifications**

Characteristic	Parameter
Switch type	SPST
Reset type	automatic
Amperage	1 A resistive
Voltage	28 Vdc/ac
Operating temperature range	40 °C to 120 °C [104 °F to 248 °F]
Environmental exposure range	-50 °C to 150 °C [-58 °F to 302 °F]
Dielectric strength	MIL-STD-202 Method 301 – 500 Vac 60 Hz for one second, terminal to case
Insulation resistance	MIL-STD-202 Method 302 Cond. B – 20 MOhm, 500 Vdc
Contact resistance	MIL-STD-202 Method 307 – 60 mOhm
Hermetic seal	MIL-STD-202 Method 112 Cond. 1x10 <sup>3</sup> Atm cc/sec
Material:	
Base	nickel
Contacts	WE-1 gold alloy cross point
Terminals	nickel/iron alloy allow, copper core
Closure	hermetically sealed
Brackets	phosphor bronze
Marking	MIL-STD-1285
Weight	1,6 g [0.06 oz] (brackets and wire leads not included)

**Table 3. 3600/3601 Series Contact Ratings**

Life Cycles	28 Vdc/ac	5 Vdc/Vac
10,000	1 A	5 mA

# Precision Thermostats

Figure 4. 3001/3004 Series Non-Hermetic Thermostats

	 <p> <b>A</b> Contacts  <b>B</b> Bimetal disc  <b>C</b> Ceramic transfer pin  <b>D</b> Metal closure  <b>E</b> Phenolic insulator  <b>F</b> Contact arm  <b>G</b> Metal sleeve (3004 only)  <b>H</b> Phenolic base  <b>I</b> Rivet (3004 only)  <b>J</b> Terminal         </p>
<p>The 3001/3004 Series is factory pre-set, single-pole, single-throw thermal switch available to open and close on temperature rise. The 3001 has a low-profile that allows it to be used in most applications where a non-hermetic precision thermostat is required for tight tolerances and the 3004 has a metal sleeve rivet construction. A metal closure makes the phenolic base dustproof and also provides thermal and electrical isolation for the silver contacts.</p>	<p>3001: Not UL/CSA approved.            3001U Vac only: UL/CSA approved.            3004 Vac and hp only: UL/CSA approved.</p> <p>Potential applications:</p> <ul style="list-style-type: none"> <li>• Computers</li> <li>• Office equipment</li> <li>• Blood analyzers</li> </ul>

Table 4. 3001/3004 Series Standard Temperature Characteristics

Operating Temperature Range °C [°F]	Tolerance		Standard Mean Differential °C [°F]	Optional Max. Differential °C [°F]
	Open °C [°F]	Close °C [°F]		
-17,8 °C to 0 °C [0 °F to 31 °F]	±3,9 [±7]	±5,0 [±9]	16,7 to 33,3 [30 to 60]	-
	±3,3 [±6]	±3,9 [±7]	8,3 to 16,1 [15 to 29]	-
0 °C to 26,1 °C [32 °F to 79 °F]	±3,3 [±6]	±4,4 [±8]	16,7 to 33,3 [30 to 60]	-
	±2,8 [±5]	±3,9 [±7]	8,3 to 16,1 [15 to 29]	-
	±2,8 [±5]	±2,8 [±5]	5,6 to 7,8 [10 to 14]	-
26,7 °C to 93,3 °C [80 °F to 200 °F]	±2,8 [±5]	±3,9 [±7]	16,7 to 33,3 [30 to 60]	-
	±2,8 [±5]	±3,3 [±6]	8,3 to 16,1 [15 to 29]	-
	±2,8 [±5]	±2,8 [±5]	5,6 to 7,8 [10 to 14]	-
	±2,8 [±5]	-	-	5,6 [10]
	-	±2,8 [±5]	-	5,6 [10]
	±2,2 [±4]	-	-	4,4 [8]
93,9 °C to 148,9 °C [201 °F to 300 °F]	±3,9 [±7]	±4,4 [±8]	16,7 to 44,4 [30 to 80]	-
	±3,9 [±7]	±3,9 [±7]	13,9 to 16,1 [25 to 29]	-
	±3,3 [±6]	±3,9 [±7]	11,1 to 13,3 [20 to 24]	-
	±3,9 [±7]	-	-	8,3 [15]
	-	±3,9 [±7]	-	8,3 [15]
	±3,3 [±6]	-	-	6,7 [12]
	-	±3,3 [±6]	-	6,7 [12]
149,4 °C to 168,3 °C [301 °F to 335 °F]	±5,6 [±10]	±6,7 [±12]	22,2 to 44,5 [40 to 80]	-
	±5,6 [±10]	±5,6 [±10]	19,5 to 21,7 [35 to 39]	-
	±4,4 [±8]	±5,6 [±10]	13,9 to 16,1 [30 to 34]	-
	±5,6 [±10]	-	-	11,1 [20]
	-	±5,6 [±10]	-	11,1 [20]
	±4,4 [±8]	-	-	10,0 [18]
-	±4,4 [±8]	-	10,0 [18]	

**Table 5. 3001/3004 Series Specifications**

Characteristic	Parameter
Switch type	SPST
Reset type	automatic
Amperage	see Tables 6, 7, 8
Voltage	120 Vac
Operating temperature range	-17,8 °C to 150 °C [0 °F to 302 °F]
Environmental exposure range	-17,8 °C to 177 °C [0 °F to 350 °F]
Dielectric strength	MIL-STD-202 Method 301 3001: 1500 Vac 60 Hz, terminal to case 3004: 2000 Vac 60 Hz, terminal to case
Insulation resistance	MIL-STD-202 Method 302 Cond. B – 500 MOhm, 500 Vdc applied
Contact resistance	MIL-STD-202 Method 307 – 50 mOhm
Material:	
Base	phenolic
Contacts	silver alloy
Terminals	plated brass or steel
Closure	aluminum, stainless steel or brass
Brackets	stainless steel or brass
Approvals	UL File E36103, CSA File LR21048
Weight	4 g [0.14 oz] (brackets and wire leads not included)

**Table 6. 3001 Contact Ratings**

Life Cycles	30 Vac/dc	120 Vac	240 Vac
5,000	7 A	6 A	3 A
10,000	6.5 A	5 A	2.5 A
25,000	6 A	4 A	2 A
50,000	5.5 A	3.3 A	1.5 A
100,000	5 A	2 A	1 A

**Table 7. 3001U Contact Ratings**

Life Cycles	120 Vac	240 Vac	250 Vac
6,000	6 A	1.5 A	1.5 A
6,000	1/10 hp	-	-
100,000	3 A	-	-

**Table 8. 3004 Contact Ratings**

Life Cycles	120 Vac	250 Vac
6,000	8 A	1.5 A
6,000	1/10 hp	-
100,000	4.0 A	-

# Precision Thermostats

Figure 5. 3150 Series Low Profile Hermetic Thermostats





**A** Glass header  
**B** Housing  
**C** Contact  
**D** Movable contact  
**E** Actuator  
**F** Laser weld  
**G** Bimetal disc  
**H** Cap  
**I** Contact arm  
**J** Weld cap  
**K** Terminals

The 3150 Series is a single-pole, single-throw switch activated by a snap-action bimetal disc. The case is laser welded to form a hermetically sealed steel housing, with a glass-to-metal seal at the terminal junction. The low profile and compact design allows it to be used in most applications that require miniaturization. Temperature calibrations are pre-set at the factory, and each unit is thermally and mechanically inspected. It is available to open or close on temperature rise. A variety of mounting brackets and terminals is available.

3150: Not UL approved.  
 3150U 120 Vac max.: UL/CSA approved.  
 3150UX 240 Vac max.: UL/CSA approved.

Potential applications:

- Office equipment
- Computers
- Aircraft
- Electronic controls

Table 9. 3150 Series Standard Temperature Characteristics

Operating Temperature Range	Tolerance		Standard Mean Differential °C [°F]	Optional Max. Differential °C [°F]
	Open °C [°F]	Close °C [°F]		
-28,89 °C to -12,2 °C [-20 °F to 10 °F]	±5,6 [±10]	±4,4 [±8]	16,7 to 22,2 [30 to 40]	-
	±4,4 [±8]	±4,4 [±8]	11,1 to 16,1 [20 to 29]	-
	±3,9 [±7]	±3,9 [±7]	7,8 to 10,6 [14 to 19]	-
-11,7 °C to 107,2 °C [11 °F to 225 °F]	±2,8 [±5]	±2,8 [±5]	11,1 to 44,4 [20 to 80]	-
	±2,8 [±5]	±2,8 [±5]	8,3 to 10,6 [15 to 19]	-
	±2,8 [±5]	±2,8 [±5]	5,6 to 7,8 [10 to 14]	-
	±2,2 [±4]	-	-	4,4 [8]
	-	±2,2 [±4]	-	4,4 [8]
	±1,7 [±3]	-	-	3,3 [6]
107,8 °C to 148,9 °C [226 °F to 300 °F]	±4,4 [±8]	±3,3 [±6]	13,9 to 27,8 [25 to 50]	-
	5,6 [±7]	±3,3 [±6]	8,3 to 13,3 [15 to 34]	-
	±3,3 [±6]	±3,3 [±6]	6,7 to 7,8 [12 to 14]	-
	±2,8 [±5]	-	-	6,7 [12]
	-	±2,8 [±5]	-	6,7 [12]
	±2,2 [±4]	-	-	4,4 [8]
149,4 °C to 176,7 °C [301 °F to 350 °F]	±6,7 [±12]	±5,6 [±10]	19,5 to 27,8 [35 to 50]	-
	±5,6 [±10]	±5,6 [±10]	13,9 to 18,9 [25 to 34]	-
	±4,4 [±8]	±4,4 [±8]	8,3 to 13,3 [15 to 24]	-
	±3,9 [±7]	-	-	8,3 [15]
	-	±3,9 [±7]	-	8,3 [15]
	±2,8 [±5]	-	-	5,6 [10]
-	±2,8 [±5]	-	5,6 [10]	



**Table 10. 3150 Series Specifications**

Characteristic	Parameter
Switch type	SPST
Reset type	automatic
Amperage	see Tables 11, 12, 13
Voltage	120 Vac
Operating temperature range	-28,89 °C to 177 °C [-20 °F to 350 °F]
Environmental exposure range	-54 °C to 260 °C [-65 °F to 500 °F]
Dielectric strength	3150: MIL-STD-202 Method 301 – 750 Vac, 60 Hz terminal to case 3150U: MIL-STD-202 Method 301 – 1250 Vac, 60 Hz terminal to case 3150UX: MIL-STD-202 Method 301 – 1500 Vac, 60 Hz terminal to case
Insulation resistance	MIL-STD-202 Method 302 Cond. B: 50 MOhm, 500 Vdc applied
Contact resistance	MIL-STD-202, Method 307: 50 mOhm
Hermetic seal	MIL-STD-202, Method 112 Cond. 1x10 <sup>5</sup> Atm cc/sec
Moisture resistance	MIL-STD-202, Method 106
Material:	
Base	cold rolled plated steel
Contacts	silver alloy
Terminals	nickel/iron alloy
Closure	hermetically sealed
Brackets	cold rolled plated steel
Plating	copper/nickel QQ-N-290
Marking	MIL-STD-1285
Approvals	UL File E36103, CSA File LR21048
Weight	5,0 g [0.17 oz] (brackets and wire leads not included)

**Table 11. 3150 Contact Ratings**

Life Cycles	30 Vac/dc	120 Vac	240 Vac
5,000	6 A	6 A	1.5 A
10,000	4 A	4 A	1.25 A
25,000	3 A	3 A	1 A
50,000	2 A	2 A	1 A
100,000	2 A	2 A	1 A

**Table 12. 3150U Contact Ratings**

Life Cycles	24 Vdc	120 Vac
6,000	–	6 A
6,000	–	1/10 hp
100,000	0.5 A	3 A

**Table 13. 3150UX Contact Ratings**

Life Cycles	240 Vac
6,000	1.5 A
100,000	0.25 A

# Precision Thermostats

Figure 6. 3156 Series Low Level/Low Profile Hermetic Thermostats





**A** Glass header  
**B** Housing  
**C** Contact  
**D** Movable contact  
**E** Actuator  
**F** Laser Weld  
**G** Bimetallic disc  
**H** Cap  
**I** Contact arm  
**J** Weld cap  
**J** Terminals

The 3156 Series is a single-pole, single-throw switch activated by a snap-action bimetal disc. It has WE-1 gold alloy cross point contacts for use in potential low voltage applications. The case is laser welded to form a hermetically-sealed steel housing, with glass-to-metal seal at the terminal junction. Its low silhouette and compact design allows use in most applications that require miniaturization. Temperature calibrations are pre-set at the factory and each unit is thermally and mechanically inspected. It is available to open or close on temperature rise. A variety of mounting brackets and terminals is available.

3156: Not UL/CSA approved.  
 3156U: UL/CSA approved.

Potential applications:

- Dry circuit applications where space is limited

Table 14. 3156 Series Standard Temperature Characteristics

Operating Temperature Range	Tolerance		Standard Mean Differential °C [°F]	Optional Max. Differential °C [°F]
	Open °C [°F]	Close °C [°F]		
-28,89 °C to -12,2 °C [-20 °F to 10 °F]	±5,6 [±10]	±4,4 [±8]	16,7 to 22,2 [30 to 40]	-
	±4,4 [±8]	±4,4 [±8]	11,1 to 16,1 [20 to 29]	-
	±3,9 [±7]	±3,9 [±7]	7,8 to 10,6 [14 to 19]	-
-11,7 °C to 107,2 °C [11 °F to 225 °F]	±2,8 [±5]	±2,8 [±5]	11,1 to 44,4 [20 to 80]	-
	±2,8 [±5]	±2,8 [±5]	8,3 to 10,6 [15 to 19]	-
	±2,8 [±5]	±2,8 [±5]	5,6 to 7,8 [10 to 14]	-
	±2,2 [±4]	-	-	4,4 [8]
	-	±2,2 [±4]	-	4,4 [8]
	±1,7 [±3]	-	-	3,3 [6]
107,8 °C to 148,9 °C [226 °F to 300 °F]	±4,4 [±8]	±3,3 [±6]	13,9 to 44,4 [25 to 80]	-
	±3,9 [±7]	±3,3 [±6]	8,3 to 13,3 [15 to 24]	-
	3,3 [±6]	±3,3 [±6]	6,7 to 7,8 [12 to 14]	-
	±2,8 [±5]	-	-	6,7 [12]
	-	±2,8 [±5]	-	6,7 [12]
	±2,2 [±4]	-	-	4,4 [8]
149,4 °C to 176,7 °C [301 °F to 350 °F]	-	±2,2 [±4]	-	4,4 [8]
	±6,7 [±12]	±5,6 [±10]	19,5 to 27,8 [35 to 50]	-
	±5,6 [±10]	±5,6 [±10]	13,9 to 18,9 [25 to 34]	-
	±4,4 [±8]	±4,4 [±8]	8,3 to 13,3 [15 to 24]	-
	±3,9 [±7]	-	-	8,3 [15]
	-	±3,9 [±7]	-	8,3 [15]
	±2,8 [±5]	-	-	5,6 [10]
	-	±2,8 [±5]	-	5,6 [10]
	-	-	-	-

**Table 15. 3156 Series Specifications**

Characteristic	Parameter
Switch type	SPST
Reset type	automatic
Amperage	500 mA
Voltage	50 Vdc
Operating temperature range	-28,89 °C to 177 °C [-20 °F to 350 °F]
Environmental exposure range	-54 °C to 260 °C [-65 °F to 500 °F]
Dielectric strength	3156: MIL-STD-202 Method 301 – 750 Vac, 60 Hz terminal to case 3156U: MIL-STD-202 Method 301 – 1250 Vac, 60 Hz terminal to case
Insulation resistance	MIL-STD-202 Method 302 Cond. B – 50 MOhm, 500 Vdc applied
Contact resistance	MIL-STD-202, Method 307 – 50 mOhm
Hermetic seal	MIL-STD-202, Method 112 Cond. 1x10 <sup>5</sup> Atm cc/sec
Moisture resistance	MIL-STD-202, Method 106
Material:	
Base	cold rolled plated steel
Contacts	WE-1 gold alloy cross point
Terminals	nickel/iron alloy
Closure	hermetically sealed
Brackets	cold rolled plated steel
Plating	copper/nickel QQ-N-290
Marking	MIL-STD-1285
Approvals	UL File E36103, CSA File LR21048
Weight	5,0 g [0.17 oz] (brackets and wire leads not included)

**Table 16. 3156 Series Contact Ratings**

Life Cycles	50 Vdc	120 Vac
100,000	500 mA	100 mA

# Precision Thermostats

Figure 7. 3100 Series Hermetic Thermostats

	 <p> <b>A</b> Housing  <b>B</b> Contact arm  <b>C</b> Ceramic insulator  <b>D</b> Laser weld  <b>E</b> Bimetal disc  <b>F</b> Ceramic transfer pin  <b>G</b> Cap  <b>H</b> Contacts  <b>I</b> Glass header  <b>J</b> Terminals         </p>
<p>The 3100 Series is a single-pole, single-throw switch activated by a snap-action bimetal disc. The case is laser welded to form a hermetically-sealed steel housing, with a glass-to-metal seal at the terminal junction. Temperature calibrations are pre-set at the factory. Each unit is thermally and mechanically inspected and tamperproof. They are available to open or close on temperature rise. A variety of mounting brackets and terminals is available.</p> <p>Preconfigured REDI-TEMP versions are available. See page 34.</p>	<p>3100 120 Vac max.: Not UL/CSA approved.            3100U 240 V: UL/CSA approved.            3100UX: UL/CSA approved.</p> <p>Potential applications include high temperature control for:</p> <ul style="list-style-type: none"> <li>• Office equipment</li> <li>• Computers</li> <li>• Aircraft</li> <li>• Electronic controls</li> </ul>

Table 17. 3100 Series Standard Temperature Characteristics

Operating Temperature Range	Tolerance		Standard Mean Differential °C [°F]	Optional Max. Differential °C [°F]
	Open °C [°F]	Close °C [°F]		
-28,89 °C to -12,2 °C [-20 °F to 10 °F]	±5,6 [±10]	±4,4 [±8]	16,7 to 22, 2 [30 to 40]	-
	±4,4 [±8]	±4,4 [±8]	11,1 to 16,1 [20 to 29]	-
	±3,9 [±7]	±3,9 [±7]	7,8 to 10,6 [14 to 19]	-
	±3,3 [±6]	-	-	4,4 [8]
	-	±3,3 [±6]	-	4,4 [8]
-11,7 °C to 93,3 °C [11 °F to 200 °F]	±2,8 [±5]	±2,8 [±5]	11,1 to 44,4 [20 to 80]	-
	±2,8 [±5]	±2,8 [±5]	8,3 to 10,6 [15 to 19]	-
	±2,8 [±5]	±2,8 [±5]	5,6 to 7,8 [10 to 14]	-
	±2,2 [±4]	-	-	4,4 [8]
	-	±2,2 [±4]	-	4,4 [8]
	±1,7 [±3]	-	-	3,3 [6]
93,9 °C to 148,9 °C [201 °F to 300 °F]	±4,4 [±8]	±3,3 [±6]	13,9 to 44,4 [25 to 80]	-
	±3,9 [±7]	±3,3 [±6]	8,3 to 13,3 [15 to 24]	-
	±3,3 [±6]	±3,3 [±6]	6,7 to 7,8 [12 to 14]	-
	±2,8 [±5]	±2,8 [±5]	5,6 to 7,8 [10 to 14]	-
	±2,2 [±4]	-	-	4,4 [8]
	-	±2,2 [±4]	-	4,4 [8]
149,4 °C to 176,7 °C [301 °F to 350 °F]	±6,7 [±12]	±5,6 [±10]	19,4 to 44,4 [35 to 80]	-
	±5,6 [±10]	±5,6 [±10]	13,9 to 18,9 [25 to 34]	-
	±4,4 [±8]	±4,4 [±8]	8,9 to 13,3 [16 to 24]	-
	±3,9 [±7]	±3,9 [±7]	7,8 to 10,0 [14 to 18]	-
	±2,8 [±5]	-	-	5,6 [10]
	-	±2,8 [±5]	-	5,6 [10]
177,2 °C to 204,4 °C [351 °F to 400 °F]	±8,3 [±15]	±8,3 [±15]	22,2 to 55,6 [40 to 100]	-
	±8,3 [±15]	±6,7 [±12]	16,7 to 21,7 [30 to 39]	-
	±5,6 [±10]	±5,6 [±10]	11,1 to 16,1 [20 to 29]	-
	±4,4 [±8]	±4,4 [±8]	8,9 to 10,6 [16 to 19]	-
	±3,3 [±6]	-	-	8,3 [15]
205 °C to 232,20 °C [401 °F to 450 °F]	±11,1 [±20]	±8,3 [±15]	22,2 to 55,6 [40 to 100]	-
232,8 °C to 260 °C [451 °F to 500 °F]	±13,9 [±25]	±13,9 [±25]	33,3 to 66,7 [60 to 120]	-

**Table 18. 3100 Series Specifications**

Characteristic	Parameter
Switch type	SPST
Reset type	automatic
Amperage	see Tables 19, 20, 21
Voltage	30 Vac/dc
Operating temperature range	-28,89 °C to 260 °C [-20 °F to 500 °F]
Environmental exposure range	-62 °C to 288 °C [-80 °F to 550 °F]
Dielectric strength	3100 and 3100U: MIL-STD-202 Method 301 – 1250 Vac, 60 Hz terminal to case 3100UX: MIL-STD-202 Method 301 – 1500 Vac, 60 Hz terminal to case
Insulation Resistance	MIL-STD-202 Method 302 Cond. B – 50 MOhm, 500 Vdc applied
Contact Resistance	MIL-STD-202, Method 307 – 50 mOhm
Hermetic seal	MIL-STD-202, Method 112 Cond. 1x10 <sup>5</sup> Atm cc/sec
Moisture resistance	MIL-STD-202, Method 106
Material:	
Base	cold rolled plated steel
Contacts	silver
Terminals	nickel/iron alloy
Closure	hermetically sealed
Brackets	cold rolled plated steel
Plating	copper/nickel QQ-N-290
Marking	Mil-STD-1285
Approvals	3100U: UL File E36103; CSA File LR21048
Weight	5,5 g [0.19 oz] (brackets and wire leads not included)

**Table 19. 3100 Contact Ratings**

Life Cycles	30 Vac/dc	120 Vac	240 Vac
5,000	7 A	6 A	3 A
10,000	6.5 A	5 A	2.5 A
25,000	6 A	4 A	2 A
50,000	5.5 A	3 A	1.5 A
100,000	5 A	2 A	1 A

**Table 20. 3100U Contact Ratings**

Life Cycles	120 Vac
6,000	6 A
6,000	1/10 hp
100,000	3 A
30,000	3 A
100,000	100 mA

**Table 21. 3100UX Contact Ratings**

Life Cycles	240 Vac
6,000	1.5 A
6,000	-
100,000	1.1025 A
30,000	-
100,000	-

# Precision Thermostats

Figure 8. 3106 Series Low Level Hermetic Thermostats

	
<p>The 3106 Series is a single-pole, single-throw switch activated by a snap-action bimetal disc. The case is laser welded to form a hermetically-sealed steel housing, with a glass-to-metal seal at the terminal junction. WE-1 gold alloy cross point contacts allow use in potential low voltage applications. Temperature calibrations are pre-set at the factory, and each unit is thermally and mechanically inspected. It is available to open or close on temperature rise. A variety of mounting brackets and terminals is available.</p>	<p>3106: Not UL/CSA approved. 3106U: UL/CSA approved.</p> <p>Potential applications:</p> <ul style="list-style-type: none"> <li>• Logic level</li> <li>• Dry circuit applications</li> </ul>

Table 22. 3106 Series Standard Temperature Characteristics

Operating Temperature Range	Tolerance		Standard Mean Differential °C [°F]	Optional Max. Differential °C [°F]
	Open °C [°F]	Close °C [°F]		
-28,89 °C to -12,2 °C [-20 °F to 10 °F]	±5,6 [±10]	±4,4 [±8]	16,7 to 22, 2 [30 to 40]	-
	±4,4 [±8]	±4,4 [±8]	11,1 to 16,1 [20 to 29]	-
	±3,9 [±7]	±3,9 [±7]	7,8 to 10,6 [14 to 19]	-
	±3,3 [±6]	-	-	4,4 [8]
	-	±3,3 [±6]	-	4,4 [8]
-11,7 °C to 93,3 °C [11 °F to 200 °F]	±2,8 [±5]	±2,8 [±5]	11,1 to 44,4 [20 to 80]	-
	±2,8 [±5]	±2,8 [±5]	8,3 to 10,6 [15 to 19]	-
	±2,8 [±5]	±2,8 [±5]	5,6 to 7,8 [10 to 14]	-
	±2,2 [±4]	-	-	4,4 [8]
	-	±2,2 [±4]	-	4,4 [8]
	±1,7 [±3]	-	-	3,3 [6]
93,9 °C to 148,9 °C [201 °F to 300 °F]	-	±1,7 [±3]	-	3,3 [6]
	±4,4 [±8]	±3,3 [±6]	13,9 to 44,4 [25 to 80]	-
	±3,9 [±7]	±3,3 [±6]	8,3 to 13,3 [15 to 24]	-
	±3,3 [±6]	±3,3 [±6]	6,7 to 7,8 [12 to 14]	-
	±2,8 [±5]	±2,8 [±5]	5,6 to 7,8 [10 to 14]	-
	±2,2 [±4]	-	-	4,4 [8]
149,4 °C to 176,7 °C [301 °F to 350 °F]	-	±2,2 [±4]	-	4,4 [8]
	±6,7 [±12]	±5,6 [±10]	19,4 to 44,4 [35 to 80]	-
	±5,6 [±10]	±5,6 [±10]	13,9 to 18,9 [25 to 34]	-
	±4,4 [±8]	±4,4 [±8]	8,9 to 13,3 [16 to 24]	-
	±3,9 [±7]	±3,9 [±7]	7,8 to 10,0 [14 to 18]	-
	±2,8 [±5]	-	-	5,6 [10]
177,2 °C to 204,4 °C [351 °F to 400 °F]	-	±2,8 [±5]	-	5,6 [10]
	±8,3 [±15]	±8,3 [±15]	22,2 to 55,6 [40 to 100]	-
	±8,3 [±15]	±6,7 [±12]	16,7 to 21,7 [30 to 39]	-
	±5,6 [±10]	±5,6 [±10]	11,1 to 16,1 [20 to 29]	-
	±4,4 [±8]	±4,4 [±8]	8,9 to 10,6 [16 to 19]	-
	±3,3 [±6]	-	-	8,3 [15]
	-	±3,3 [±6]	-	8,3 [15]

**Table 23. 3106 Series Specifications**

Characteristic	Parameter
Switch type	SPST
Reset type	automatic
Amperage	500 mA
Voltage	50 Vdc
Operating temperature range	-29 °C to 204,4 °C [-20 °F to 400 °F]
Environmental exposure range	-62 °C to 260 °C [80 °F to 500 °F]
Dielectric strength	MIL-STD-202 Method 301 – 1250 Vac 60 Hz, terminal to case
Insulation resistance	MIL-STD-202 Method 302 Cond. B – 50 MOhm, 500 Vdc applied
Contact resistance	MIL-STD-202, Method 307 – 25 mOhm
Hermetic seal	MIL-STD-202, Method 112 Cond. 1x10 <sup>5</sup> Atm cc/sec
Moisture resistance	MIL-STD-202, Method 106
Material:	
Base	cold rolled plated steel
Contacts	WE-1 gold alloy cross point
Terminals	nickel/iron alloy
Closure	hermetically sealed
Brackets	cold rolled plated steel
Plating	copper/nickel QQ-N-290
Marking	MIL-STD 1285
Approvals	UL File E36103, CSA File LR21048
Weight	5,5 g [0.19 oz] (brackets and wire leads not included)

**Table 24. 3106 Series Contact Ratings**

Life Cycles	24 Vdc	50 Vdc	120 Vac
100,000	500 mA	500 mA	100 mA

# Precision Thermostats

Figure 9. 3800 Series Industrial Grade Thermostats for Severe Duty Applications

	 <p> <b>A</b> Contacts  <b>B</b> Ceramic insulator  <b>C</b> Disc retainer  <b>D</b> Laser weld  <b>E</b> Bimetal disc  <b>F</b> Ceramic transfer pin  <b>G</b> Cap  <b>H</b> Capping washer  <b>I</b> Contact arm  <b>J</b> Weld cap  <b>K</b> Glass header  <b>L</b> Terminal         </p>
<p>The 3800 Series uses the same materials and manufacture as Honeywell's military-grade thermostats, allowing them to be used where high levels of vibration and mechanical shock are common but a military device is not required. Originally designed for use in motor protection applications, the 3800 Series is now used in commercial aircraft, such as the Boeing 737, 747, 757, 767 and 777, and other applications where severe duty may be encountered.</p>	<p>Available in UL and CSA versions. Please contact Honeywell.</p> <p>Potential applications:</p> <ul style="list-style-type: none"> <li>• Commercial aircraft</li> <li>• Industrial</li> <li>• HVAC</li> </ul>

Table 25. Standard Temperature Characteristics

Operating Temperature Range	Tolerance		Standard Mean Differential °C [°F]	Optional Max. Differential °C [°F]
	Open °C [°F]	Close °C [°F]		
-28,9 °C to -12,2 °C [-20 °F to 10 °F]	±5,6 [±10]	±4,4 [±8]	16,7 to 22,2 [30 to 40]	-
	±4,4 [±8]	±4,4 [±8]	11,1 to 16,1 [20 to 29]	-
	±3,9 [±7]	±3,9 [±7]	7,8 to 10,6 [14 to 19]	-
	±3,3 [±6]	-	-	4,4 [8]
	-	±3,3 [±6]	-	4,4 [8]
-11,7 °C to 93,3 °C [11 °F to 200 °F]	±2,8 [±5]	±2,8 [±5]	11,1 to 44,4 [20 to 80]	-
	±2,8 [±5]	±2,8 [±5]	8,3 to 10,6 [15 to 19]	-
	±2,8 [±5]	±2,8 [±5]	5,6 to 7,8 [10 to 14]	-
	±2,2 [±4]	-	-	4,4 [8]
	-	±2,2 [±4]	-	4,4 [8]
	±1,7 [±3]	-	-	3,3 [6]
93,9 °C to 148,9 °C [201 °F to 300 °F]	-	±1,7 [±3]	-	3,3 [6]
	±4,4 [±8]	±3,3 [±6]	13,9 to 44,4 [25 to 80]	-
	±3,9 [±7]	±3,3 [±6]	8,3 to 13,3 [15 to 24]	-
	±3,3 [±6]	±3,3 [±6]	6,7 to 7,8 [12 to 14]	-
	±2,8 [±5]	±2,8 [±5]	5,6 to 7,8 [10 to 14]	-
	±2,2 [±4]	-	-	4,4 [8]
149,4 °C to 176,7 °C [301 °F to 350 °F]	-	±2,2 [±4]	-	4,4 [8]
	±6,7 [±12]	±5,6 [±10]	19,4 to 44,4 [35 to 80]	-
	±5,6 [±10]	±5,6 [±10]	13,9 to 18,9 [25 to 34]	-
	±4,4 [±8]	±4,4 [±8]	8,9 to 13,3 [16 to 24]	-
	±3,9 [±7]	±3,9 [±7]	7,8 to 10,0 [14 to 18]	-
	±2,8 [±5]	-	-	5,6 [10]
177,2 °C to 204,4 °C [351 °F to 400 °F]	-	±2,8 [±5]	-	5,6 [10]
	±8,3 [±15]	±8,3 [±15]	22,2 to 55,6 [40 to 100]	-
	±8,3 [±15]	±6,7 [±12]	16,7 to 21,7 [30 to 39]	-
	±5,6 [±10]	±5,6 [±10]	11,1 to 16,1 [20 to 29]	-
	±4,4 [±8]	±4,4 [±8]	8,9 to 10,6 [16 to 19]	-
	±3,3 [±6]	-	-	6,7 [12]
205 °C to 232,2 °C [401 °F to 450 °F]	-	±3,3 [±6]	-	6,7 [12]
	±11,1 [±20]	±8,3 [±15]	22,2 to 55,6 [40 to 100]	-
232,8 °C to 260 °C [541 °F to 500 °F]	±13,9 [±25]	±13,9 [±25]	33,3 to 66,7 [60 to 120]	-



**Table 26. 3800 Series Specifications**

Characteristic	Parameter
Switch type	SPST
Reset type	automatic
Amperage	see Table 27
Voltage	120 Vac
Operating temperature range	-28.9 °C to 260 °C [-20 °F to 500 °F]
Environmental exposure range	-62 °C to 288 °C [-80 °F to 550 °F]
Dielectric strength	MIL-STD-202 Method 301, 1250 Vac 60 Hz, terminal to case
Insulation resistance	MIL-STD-202 Method 302 Cond. B, 50 MOhm, minimum terminal to case
Contact resistance	MIL-STD-202 Method 307, 50 mOhm max.
Hermetic seal	MIL-STD-202, Method 112, Cond. A, A x 10 <sup>-5</sup> atm cc/sec
Vibration (random)	MIL-STD-202, Method 214, 30 Grms, 20 Hz to 2,000 Hz
Vibration (sinusoidal)	MIL-STD-202, Method 204, Cond. D 20 G, 20 Hz to 2,000 Hz
Mechanical shock	MIL-STD-202, Method 213, 400 G
Thermal shock	MIL-STD-202, Method 107, Cond. B
Acceleration	MIL-STD-202, Method 212, 20 G
Moisture resistance	MIL-STD-202, Method 106
Material:	
Base	cold plated steel
Contacts	silver alloy
Terminals	Ni/Fe Alloy
Closure	hermetically sealed
Brackets	cold rolled plated steel
Marking	MIL-STD-1285
Weight	7.5 g [0.26 oz] (brackets and wires not included)

**Table 27. 3800 Series Contact Ratings**

Life Cycles	30 Vac/dc	120 Vac	240 Vac
5,000	7 A	6 A	3 A
10,000	6.5 A	5 A	2.5 A
25,000	6 A	4 A	2 A
50,000	5.5 A	3 A	1.5 A
100,000	5 A	2 A	1

# Precision Thermostats

Figure 10. 3000 Series (345X Series Internal) Custom Packaged Thermostats



Table 28. 3000 Series (345X Series Internal) Specifications

Characteristic	Parameter
Switch type	custom
Reset type	automatic
Amperage	custom
Voltage	custom
Operating temperature range	-40 °C to 204 °C [-40 °F to 400 °F]
Environmental exposure range	-65 °C to 260 °C [-85 °F to 500 °F]
Dielectric strength	MIL-STD-202, Method 301, 1250 Vac
Insulation Resistance	MIL-STD-202, Method 302, 500 MOhm
Contact Resistance	MIL-STD-202, Method 307, 50 mOhm max.
Hermetic seal	MIL-STD-202, Method 112 Cond. A
Moisture resistance	MIL-STD-202, Method 106
Shock	MIL-STD-202, Method 213, 100 G
Vibration	MIL-STD-202, Method 204, 20 G
Thermal shock	MIL-STD-202, Method 107, Cond. B
Salt spray	MIL-STD-202, Method 101, Cond. B
Housing material	stainless steel and brass
Weight	72 g [2.5 oz]

**HIGH RELIABILITY THERMOSTATS**

Tables 29 and 30 provide overall performance qualifications for the High Reliability Thermostats. Figure 11 indicates potential applications.

**Table 29. Performance Qualifications, Part 1**

Series Name	Shock	Vibration	Acceleration	Thermal Shock	Dielectric Strength
3200 3200EM	MIL-STD-202 Method 213 – 750 G	MIL-STD-202 Method 204 – 30 G MIL-STD-202 Method 21 – 50 G	MIL-STD-202 Method 212 – 20 G	MIL-STD-202 Method 107 – Cond. B	MIL-STD-202 Method 301 – 1250 Vac
3MS1 QPL	MIL-STD-202 Method 213 – 100 G	MIL-STD-202 Method 204 – 20 G			
3500	MIL-STD-202 Method 213 – 400 G		N/A		
3153	MIL-STD-202				
3000	Method 213 – 100 G				

**Table 30. Performance Qualifications, Part 2**

Series Name	Insulation Resistance	Contact Resistance	Hermetic Seal	Moisture Resistance	Salt Spray*
3200	MIL-STD-202 Method 302 – 500 MOhm	MIL-STD-202 Method 307 – 0.025 Ohm max.	MIL-STD-202 Method 112 – Cond. C	MIL-STD-202 Method 106	MIL-STD-202 Method 101 – Cond. B
3MS1 QPL		MIL-STD-202 Method 307 – 0.055 Ohm max.			
3500					
3153					
3000					

\*Not applicable to 3153 and 3500 Series with mounting brackets and operating temperatures exceeding 162,8 °C [325 °F].

**Figure 11. High Reliability Thermostat Potential Applications**



# Precision Thermostats

## HIGH RELIABILITY MILITARY AND AEROSPACE THERMOSTATS

Figure 12. 3153 Series Low Profile Thermostats

	
<p>The 3153 Series is a single-pole, single-throw switch activated by a snap-action bimetal disc. The case is laser welded to form a hermetically-sealed steel housing, with a glass-to-metal seal at the terminal junction. The low profile and compact design allow use in most applications that require miniaturization. Temperature calibrations are pre-set at the factory and each unit is thermally and mechanically inspected. It is available to open or close on temperature rise.</p>	<p>Potential applications:</p> <ul style="list-style-type: none"> <li>• Non QPL military</li> <li>• Commercial aircraft</li> <li>• Aircraft batteries</li> </ul>

Table 31. 3153 Series Standard Temperature Characteristics

Temperature Setpoint Range	Tolerance		Nominal Differential °C [°F]	Max. Differential °C [°F]
	Open °C [°F]	Close °C [°F]		
-28,89 °C to -12,2 °C [-20 °F to 10 °F]	±5,6 [±10]	±4,4 [±8]	16,7 to 22,2 [30 to 40]	-
	±4,4 [±8]	±4,4 [±8]	11,1 to 16,1 [20 to 29]	-
	±3,9 [±7]	±3,9 [±7]	11,1 to 16,1 [20 to 29]	-
-11,7 °C to 9,4 °C [11 °F to 49 °F]	±2,8 [±5]	±2,8 [±5]	11,1 to 22,2 [20 to 40]	-
	±2,8 [±5]	±2,8 [±5]	8,3 to 10,6 [15 to 19]	-
	±2,8 [±5]	±2,8 [±5]	6,1 to 7,8 [11 to 14]	-
	<b>Open or Close Only</b>		-	4,4 [8]
10 °C to 107,2 °C [50 °F to 225 °F]	±2,8 [±5]	±2,8 [±5]	11,1 to 22,2 [20 to 40]	-
	±2,8 [±5]	±2,8 [±5]	8,3 to 10,6 [15 to 19]	-
	±2,8 [±5]	±2,8 [±5]	6,1 to 7,8 [11 to 14]	-
	<b>Open or Close Only</b>		-	4,4 [8]
107,8 °C to 148,9 °C [226 °F to 350 °F]	±4,4 [±8]	±3,3 [±6]	13,9 to 27,8 [25 to 50]	-
	±3,9 [±7]	±3,3 [±6]	11,1 to 13,3 [20 to 24]	-
	±3,3 [±6]	±3,3 [±6]	8,3 to 10,6 [15 to 19]	-
	<b>Open or Close Only</b>		-	6,7 [12]
149,4 °C to 176,7 °C [301 °F to 350 °F]	±6,7 [±12]	±5,6 [±10]	19,5 to 27,8 [35 to 50]	-
	±5,6 [±10]	±5,6 [±10]	13,6 to 18,9 [25 to 34]	-
	±4,4 [±8]	±4,4 [±8]	8,3 to 13,3 [15 to 24]	-
	<b>Open or Close Only</b>		-	8,3 [15]

**Table 32. 3153 Series Specifications**

Characteristic	Parameter
Switch type	SPST
Reset type	automatic
Amperage	5 A resistive
Voltage	28 Vac/dc
Operating temperature range	-29 °C to 177 °C [-20 °F to 350 °F]
Environmental exposure range	-65 °C to 260 °C [-85 °F to 500 °F]
Dielectric strength	MIL-STD-202, Method 301, 1250 Vac
Insulation resistance	MIL-STD-202, Method 302, 500 MOhm
Contact resistance	MIL-STD-202, Method 307, 50 mOhm max.
Hermetic seal	MIL-STD-202, Method 112, Cond. A
Moisture resistance	MIL-STD-202, Method 106
Shock	MIL-STD-202, Method 213, 100 G
Vibration	MIL-STD-202, Method 204, 20 G
Thermal shock	Mil-STD-202, Method 107, Cond. B
Salt spray*	Mil-STD-202, Method 101, Cond. B
Housing material	cold rolled plated steel
Marking	MIL-STD-1285
Weight	6 g [0.12 oz] (brackets not included)
Approvals	Acceptance testing performed in accordance with MIL-PRF-24236, Table III.

\*Not applicable to thermostats with brackets or those operating at temperatures above 162,8°C [325 °F].

**Table 33. 3153 Series Contact Ratings**

Load Type	Life Cycles	28 Vac/dc	115 Vac
Resistive	100,000	5 A	2 A
Inductive	100,000	2.5 A	1 A
Lamp	100,000	1 A	0.5 A

# Precision Thermostats

Figure 13. 3500 Series Military Thermostats

	 <p> <b>A</b> Contacts  <b>B</b> Ceramic insulator  <b>C</b> Disc retainer  <b>D</b> Laser weld  <b>E</b> Bimetal disc  <b>F</b> Ceramic transfer pin  <b>G</b> Cap  <b>H</b> Capping washer  <b>I</b> Contact arm  <b>J</b> Backfill dry gas  <b>K</b> Weld cap  <b>L</b> Glass header  <b>M</b> Terminals         </p>
<p>The 3500 Series is a single-pole, single-throw switch activated by a snap-action bimetal disc. It meets or exceeds the requirements of MIL-PRF-24236 and is designed for potential military and commercial aircraft applications. It is not QPL listed (see the 3MS1 QPL Series). The case is laser welded to form a hermetically sealed steel housing, with a glass-to-metal seal at the terminal junction. Temperature calibrations are preset at the factory, and each unit is thermally and mechanically inspected. It is available to open or close on temperature rise.</p>	<p>Potential applications:</p> <ul style="list-style-type: none"> <li>• Military aircraft</li> <li>• Commercial aircraft</li> <li>• Military vehicles</li> </ul>

Table 34. 3500 Series Standard Temperature Characteristics

Temperature Setpoint Range	Tolerance		Nominal Differential °C [°F]	Max. Differential °C [°F]
	Open °C [°F]	Close °C [°F]		
-45,6 °C to 17,8 °C [-50 °F to 0 °F]	±8,3 [±15]	±8,3 [±15]	16,7 to 33,3 [30 to 60]	-
	±5,6 [±10]	±5,6 [±10]	16,7 to 33,3 [30 to 60]	-
	±4,4 [±8]	±4,4 [±8]	11,1 to 27,8 [20 to 50]	-
-17,2 °C to 93,3 °C [1 °F to 200 °F]	±8,3 [±15]	±8,3 [±15]	16,7 to 33,3 [30 to 60]	-
	±5,6 [±10]	±5,6 [±10]	16,7 to 33,3 [30 to 60]	-
	±4,4 [±8]	±4,4 [±8]	11,1 to 27,8 [20 to 50]	-
	±2,8 [±5]	±2,8 [±5]	5,6 to 22,2 [10 to 40]	-
	±2,2 [±4]	-	-	4,4 [8]
	-	±2,2 [±4]	-	4,4 [8]
93,9 °C to 148,9 °C [201 °F to 300 °F]	±8,3 [±15]	±8,3 [±15]	16,7 to 33,3 [30 to 60]	-
	±5,6 [±10]	±5,6 [±10]	16,7 to 33,3 [30 to 60]	-
	±4,4 [±8]	±4,4 [±8]	11,1 to 27,8 [20 to 50]	-
	±2,8 [±5]	±2,8 [±5]	5,6 to 22,2 [10 to 40]	-
	±2,2 [±4]	-	-	4,4 [8]
	-	±2,2 [±4]	-	4,4 [8]
149,4 °C to 176,6 °C [301 °F to 350 °F]	±8,3 [±15]	±8,3 [±15]	16,7 to 33,3 [30 to 60]	-
	±5,6 [±10]	±5,6 [±10]	16,7 to 33,3 [30 to 60]	-
	±4,4 [±8]	±4,4 [±8]	11,1 to 27,8 [20 to 50]	-
	±2,8 [±5]	-	-	5,5 [10]
	-	2,8 [±5]	-	5,5 [10]
177,2 °C to 204,4 °C [351 °F to 400 °F]	±8,3 [±15]	±8,3 [±15]	16,7 to 44,4 [30 to 80]	-
	±5,6 [±10]	±5,6 [±10]	16,7 to 33,3 [30 to 60]	-
	±4,4 [±8]	±4,4 [±8]	8,3 to 10,6 [15 to 19]	-
	±3,3 [±6]	-	-	8,3 [15]
	-	±4,4 [±8]	-	8,3 [15]

Table 35. 3500 Series Specifications

Characteristic	Parameter
Switch type	SPST
Reset type	automatic
Amperage	5 A resistive
Voltage	28 Vdc
Operating temperature range	-51 °C to 204 °C [-60 °F to 400 °F]
Environmental exposure range	-65 °C to 260 °C [-85 °F to 500 °F]
Dielectric strength	MIL-STD-202, Method 301, 1250 Vac
Insulation resistance	MIL-STD-202, Method 302, 500 MOhm
Contact resistance	MIL-STD-202, Method 307, 50 mOhm max.
Hermetic seal	MIL-STD-202, Method 112, Cond. C
Moisture resistance	MIL-STD-202, Method 106
Shock	MIL-STD-202, Method 213, 400 G
Vibration	MIL-STD-202, Method 204, 20 G
Acceleration	MIL-STD-202, Method 212, 20 G
Thermal shock	MIL-STD-202, Method 107, Cond. B
Salt spray*	MIL-STD-202, Method 101, Cond. B
Housing material	cold rolled plated steel
Marking	MIL-STD-1285
Weight	7,5 g [0.26 oz] (brackets and lead wire not included)

\*Not applicable to thermostats with brackets or those operating at temperatures above 162,8°C [325 °F].

Table 36. 3500 Series Contact Ratings

Load Type	Life Cycles	28 Vac/dc	115 Vac
Resistive	100,000	5 A	2 A
Inductive	100,000	2.5 A	1 A
Lamp	100,000	1 A	0.5 A

# Precision Thermostats

Figure 14. 3000 Series (3500 Series or Other Internal) Custom Packaged Thermostats



The 3000 Series is customizable. Features include internal and external design options, all-welded hermetically sealed stainless steel construction, customized probe length (152 mm [6 in]) and a hermetic connector or potted construction.

A typical 3000 Series configuration includes:

- 3500 Series or other thermostat
- Termination selection
- Housing selection
- Customized part number

Potential applications:

- HVAC
- Liquid bath control
- Transportation

Table 37. 3000 Series (3500 Series or Other Internal) Specifications

Characteristic	Parameter
Switch type	Custom
Reset type	Automatic
Amperage	Custom
Voltage	Custom
Operating temperature range	-40 °C to 204 °C [-40 °F to 400 °F]
Environmental exposure range	-65 °C to 260 °C [-85 °F to 500 °F]
Dielectric strength	MIL-STD-202, Method 301, 1250 Vac
Insulation Resistance	MIL-STD-202, Method 302, 500 MOhm
Contact Resistance	MIL-STD-202, Method 307, 50 mOhm max.
Hermetic seal	MIL-STD-202, Method 112 Cond. A
Moisture resistance	MIL-STD-202, Method 106
Shock	MIL-STD-202, Method 213, 100 G
Vibration	MIL-STD-202, Method 204, 20 G
Thermal shock	MIL-STD-202, Method 107, Cond. B
Salt spray	MIL-STD-202, Method 101, Cond. B
Housing material	stainless steel
Weight	72 g [2.5 oz]



Figure 15. 3MS1 QPL Series Military Thermostats

	 <ul style="list-style-type: none"> <li><b>A</b> Contacts</li> <li><b>B</b> Ceramic insulator</li> <li><b>C</b> Disc retainer</li> <li><b>D</b> Laser weld</li> <li><b>E</b> Bimetal disc</li> <li><b>F</b> Ceramic transfer pin</li> <li><b>G</b> Cap</li> <li><b>H</b> Capping washer</li> <li><b>I</b> Contact arm</li> <li><b>J</b> Backfill dry gas</li> <li><b>K</b> Weld cap</li> <li><b>L</b> Glass header</li> <li><b>M</b> Terminal</li> </ul>
<p>The 3MS1 QPL Series is a single-pole, single-throw switch activated by a snap-action bimetal disc. It is qualified to MIL-PRF-24236, Type 1, Class 4, and is QPL listed for military applications. The case is laser welded to form a hermetically-sealed steel housing, with a glass-to-metal seal at the terminal junction. Temperature calibrations are pre-set at the factory and each unit is thermally and mechanically inspected. It is available to open or close on temperature rise. Available mounting brackets and terminal configurations are in accordance with the M-24236/1 Military Specification Sheet.</p>	<p>Potential applications:</p> <ul style="list-style-type: none"> <li>• Military aircraft</li> <li>• Military vehicles</li> </ul>

Table 38. 3MS1 QPL Series Standard Temperature Characteristics

Temperature Setpoint Range	Tolerance		Nominal Differential °C [°F]
	Open °C [°F]	Close °C [°F]	
-45,6 °C to 17,8 °C [-50 °F to 0 °F]	±13,9 [±25]	±13,9 [±25]	33,3 to 55,5 [60 to 100]
	±8,3 [±15]	±8,3 [±15]	22,2 to 44,4 [40 to 80]
	±5,6 [±10]	±5,6 [±10]	16,7 to 33,3 [30 to 60]
	±4,4 [±8]	±4,4 [±8]	11,1 to 27,8 [20 to 50]
-17,2 °C to 93,3 °C [1 °F to 200 °F]	±13,9 [±25]	±13,9 [±25]	33,3 to 55,5 [60 to 100]
	±8,3 [±15]	±8,3 [±15]	22,2 to 44,4 [40 to 80]
	±5,6 [±10]	±5,6 [±10]	16,7 to 33,3 [30 to 60]
	±4,4 [±8]	±4,4 [±8]	11,1 to 27,8 [20 to 50]
	±2,8 [±5]	±2,8 [±5]	5,6 to 22,2 [10 to 40]
	±1,7 [±3]	±1,7 [±3]	5,6 to 11,1 [10 to 20]
93,9 °C to 148,9 °C [201 °F to 300 °F]	±13,9 [±25]	±13,9 [±25]	33,3 to 55,5 [60 to 100]
	±8,3 [±15]	±8,3 [±15]	22,2 to 44,4 [40 to 80]
	±5,6 [±10]	±5,6 [±10]	16,7 to 33,3 [30 to 60]
	±4,4 [±8]	±4,4 [±8]	11,1 to 27,8 [20 to 50]
	±2,8 [±5]	±2,8 [±5]	5,6 to 22,2 [10 to 40]
149,4 °C to 191 °C [301 °F to 375 °F]	±13,9 [±25]	±13,9 [±25]	33,3 to 55,5 [60 to 100]
	±8,3 [±15]	±8,3 [±15]	22,2 to 44,4 [40 to 80]
	±5,6 [±10]	±5,6 [±10]	16,7 to 33,3 [30 to 60]
	±4,4 [±8]	±4,4 [±8]	11,1 to 27,8 [20 to 50]

# Precision Thermostats

**Table 39. 3MS1 QPL Series Specifications**

Characteristic	Parameter
Switch type	SPST
Reset type	automatic
Amperage	5 A resistive
Voltage	28 Vac/Vdc
Operating temperature range	-20 °C to 350 °C [-50 °F to 177 °F]
Environmental exposure range	-65 °C to 260 °C [-85 °F to 500 °F]
Dielectric strength	MIL-STD-202, Method 301, 1250 Vac
Insulation resistance	MIL-STD-202, Method 302, 500 MOhm
Contact resistance	MIL-STD-202, Method 307, 50 MOhm max.
Hermetic seal	MIL-STD-202, Method 112, Cond. C
Moisture resistance	MIL-STD-202, Method 106
Shock	MIL-STD-202, Method 213, 100 G
Vibration	MIL-STD-202, Method 204, 20 G
Acceleration	MIL-STD-202, Method 212, 20 G
Thermal shock	MIL-STD-202, Method 107, Cond. B
Salt spray	MIL-STD-202, Method 101, Cond. B
Housing material	cold rolled plated steel
Marking	MIL-STD-1285
Approvals	QPL Mil-PRF-24236/1
Weight	7,5 g [0.26 oz]

**Table 40. 3MS1 QPL Series Contact Ratings**

Load Type	Life Cycles	28 Vac/dc	115 Vac
Resistive	100,000	5 A	2 A
Inductive	100,000	2.5 A	1 A
Lamp	100,000	1 A	0.5 A

Figure 16. 3200 Series High Reliability Aerospace Thermostats

			
<p>The 3200 Series is a single-pole, single-throw switch activated by a snap-action bimetal disc. It is manufactured and tested to meet or exceed critical military and aerospace specifications for spaceflight use, including temperature stability, shock, vibration and cleanliness. The case is laser welded to form a hermetically-sealed steel housing, with a glass-to-metal seal at the terminal junction. Temperature calibrations are pre-set at the factory and each unit is thermally and mechanically inspected. It is available to open or close on temperature rise.</p> <p>The 3200EM (Engineering Model) version is produced using the same components as the 3200, but is not subjected to the rigors of extensive flight testing. It is specifically designed for ground and experimental testing.</p>	<table border="1" style="width: 100%; border-collapse: collapse;"> <tr> <td style="width: 50%;"> <p><b>A</b> Contacts  <b>B</b> Ceramic insulator  <b>C</b> Ceramic pin guide  <b>D</b> Disc retainer  <b>E</b> Laser weld  <b>F</b> Bimetal disc  <b>G</b> Ceramic transfer pin</p> </td> <td style="width: 50%;"> <p><b>H</b> Cap  <b>I</b> Contact arm  <b>J</b> Backfill dry gas  <b>K</b> Weld cap  <b>L</b> Glass header  <b>M</b> Terminals</p> </td> </tr> </table> <p>Potential applications:</p> <ul style="list-style-type: none"> <li>• Satellites</li> <li>• Rockets</li> <li>• Missiles</li> </ul>	<p><b>A</b> Contacts  <b>B</b> Ceramic insulator  <b>C</b> Ceramic pin guide  <b>D</b> Disc retainer  <b>E</b> Laser weld  <b>F</b> Bimetal disc  <b>G</b> Ceramic transfer pin</p>	<p><b>H</b> Cap  <b>I</b> Contact arm  <b>J</b> Backfill dry gas  <b>K</b> Weld cap  <b>L</b> Glass header  <b>M</b> Terminals</p>
<p><b>A</b> Contacts  <b>B</b> Ceramic insulator  <b>C</b> Ceramic pin guide  <b>D</b> Disc retainer  <b>E</b> Laser weld  <b>F</b> Bimetal disc  <b>G</b> Ceramic transfer pin</p>	<p><b>H</b> Cap  <b>I</b> Contact arm  <b>J</b> Backfill dry gas  <b>K</b> Weld cap  <b>L</b> Glass header  <b>M</b> Terminals</p>		

Table 41. 3200 Series Standard Temperature Characteristics

Temperature Setpoint Range	Tolerance		Nominal Differential °C [°F]
	Open °C [°F]	Close °C [°F]	
-51,1 °C to -29,4 °C [-60 °F to -21 °F]	consult factory		consult factory
-28,9 °C to 17,8 °C [-20 °F to 0 °F]	±4,4 [±8]	±3,9 [±7]	10,6 to 16,7 [19 to 30]
	±3,9 [±7]	±3,3 [±6]	9,4 to 15,0 [17 to 27]
	±3,3 [±6]	±3,3 [±6]	8,9 to 14,5 [16 to 26]
	±3,3 [±6]	±2,8 [±5]	8,3 to 13,9 [15 to 25]
	±2,8 [±5]	±2,8 [±5]	8,3 to 13,9 [15 to 25]
17,2 °C to 37,8 °C [1 °F to 100 °F]	±3,9 [±7]	±3,3 [±6]	9,4 to 15,0 [17 to 27]
	±3,3 [±6]	±3,3 [±6]	8,9 to 13,9 [16 to 25]
	±3,3 [±6]	±2,8 [±5]	8,3 to 13,9 [15 to 25]
	±2,8 [±5]	±2,8 [±5]	7,8 to 13,9 [14 to 25]
	±2,2 [±4]	±2,2 [±4]	7,2 to 13,9 [13 to 25]
38,3 °C to 93,3 °C [101 °F to 200 °F]	±5,0 [±9]	±4,4 [±8]	11,7 to 16,7 [21 to 30]
	±3,9 [±7]	±3,3 [±6]	9,4 to 16,7 [17 to 30]
	±3,3 [±6]	±2,8 [±5]	8,3 to 16,75 [15 to 30]
	±2,8 [±5]	±2,8 [±5]	7,8 to 13,9 [14 to 25]
93,9 °C to 162,8 °C [200 °F to 325 °F]	±5,6 [±10]	±5,0 [±9]	12,8 to 19,4 [23 to 35]
	±4,4 [±8]	±3,3 [±6]	10,0 to 19,4 [18 to 35]
	±3,9 [±7]	±3,3 [±6]	9,4 to 19,4 [17 to 35]
	±3,3 [±6]	±3,3 [±6]	8,9 to 19,4 [16 to 35]

# Precision Thermostats

**Table 42. 3200 Series Specifications**

Characteristic	Parameter
Switch type	SPST
Reset type	automatic
Amperage	5 A resistive
Voltage	28 Vac/Vdc
Operating temperature range	-51 °C to 162,8 °C [-60 °F to 325 °F]
Environmental exposure range	-65 °C to 177 °C [-85 °F to 350 °F]
Dielectric strength	MIL-STD-202, Method 301, 1250 Vac
Insulation resistance	MIL-STD-202, Method 302, 500 MOhm
Contact resistance	MIL-STD-202, Method 307, 25 mOhm max.
Hermetic seal	MIL-STD-202, Method 112, Cond. C
Moisture resistance	MIL-STD-202, Method 106
Shock	MIL-STD-202, Method 213, 750 G
Vibration	MIL-STD-202, Method 204, 30 G, MIL-STD-202, Method 214, 50 G
Acceleration	MIL-STD-202, Method 212, 20 G
Thermal shock	MIL-STD-202, Method 107, Cond. B
Salt spray	MIL-STD-202, Method 101, Cond. B
Housing material	cold rolled plated steel
Marking	MIL-STD-1285
Approvals	NASA GSFC S-311-641, S-311-641/01
Weight	8,5 g [0.30 oz] (brackets and lead wires not included)

**Table 43. 3200 Series Contact Ratings**

Load Type	Life Cycles	28 Vac/dc	115 Vac
Resistive	100,000	5 A	2 A
Inductive	100,000	2.5 A	1 A
Lamp	100,000	1 A	0.5 A

**MOUNTING HARDWARE**

**3600/3601 Series**

**Figure 17. 3600/3601 Series Brackets**



**Figure 18. 3600/3601 Series Terminals**



**3001/3004 Series**

**Figure 19. 3001/3004 Brackets**



# Precision Thermostats

Figure 20. 3001/3004 Series Cap Studs



Figure 22. 3001/3004 Series Terminals



3100/3106 Series

Figure 23. 3100/3106 Terminals



3150/3156 Series

Figure 24. 3150/3156 Terminals



3000 Series

Figure 25. 3000 Series





A Specify wire gauge and insulation

B Specify dimension

# Precision Thermostats

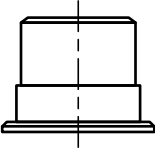
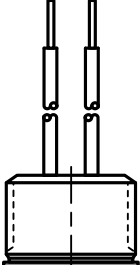
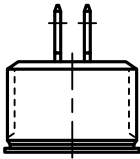
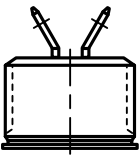
**Figure 26. 3000 Series Terminations**

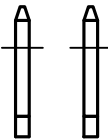
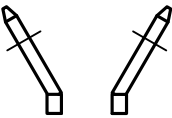
<p><b>0</b> Hermetic connector, bayonet or threaded</p> 	<p><b>3</b> 1/2-1/4 NPT thread, wire leads and lengths as required</p> 	<p><b>4a</b> 1/2-1/4 NPT thread, 0.25 in male quick connect terminals</p> 	<p><b>4b</b> 1/2-1/4 NPT thread 60° 0.25 in male quick connect terminals</p> 
<p><b>1</b> Wire leads and lengths as required</p> 	<p><b>2a</b> 0.25 in male quick connect terminals</p> 	<p><b>2b</b> 60° 0.25 in male quick connect terminals</p> 	

**Figure 27. 3000 Series Housings: Used with Terminations 0, 3, 4a, 4b, 1, 2a, 2b only.**

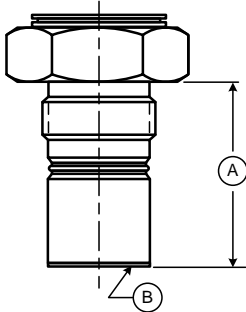
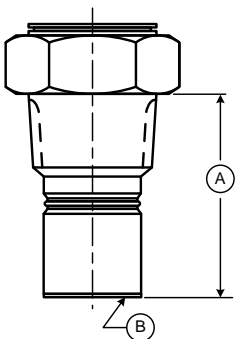
<p><b>3000-45X</b> 3/4-16 UNF-3A thread, 1 in hex.</p> 	<p><b>3000-55X</b> 1/2-14 NPT thread, 7/8 in hex.</p> 
<p><b>A</b> Probe length <b>B</b> Sensing surface</p>	

**Figure 28. 3000 Series Housings: Used with Terminations 0, 3, 4a, 4b only.**

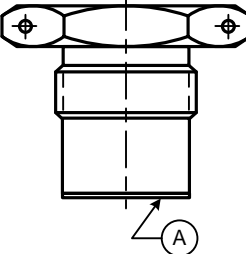
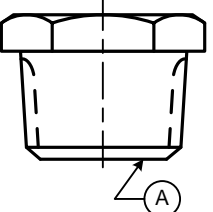
<p><b>3000-141</b> 3/4-16 UNF-3A thread, 1 in hex.</p> 	<p><b>3000-53X</b> 1/2-14 NPT thread, 7/8 in hex.</p> 
<p><b>A</b> Sensing surface</p>	



**Used on All Series**

Overmolds provide electrical isolation. Examples in Fig. 29 use the 3100/3106 Series; however, overmolds may be used on other series. Please consult Honeywell.

**Figure 29. Overmolds used on All Series (3100/3106 Series Shown).**

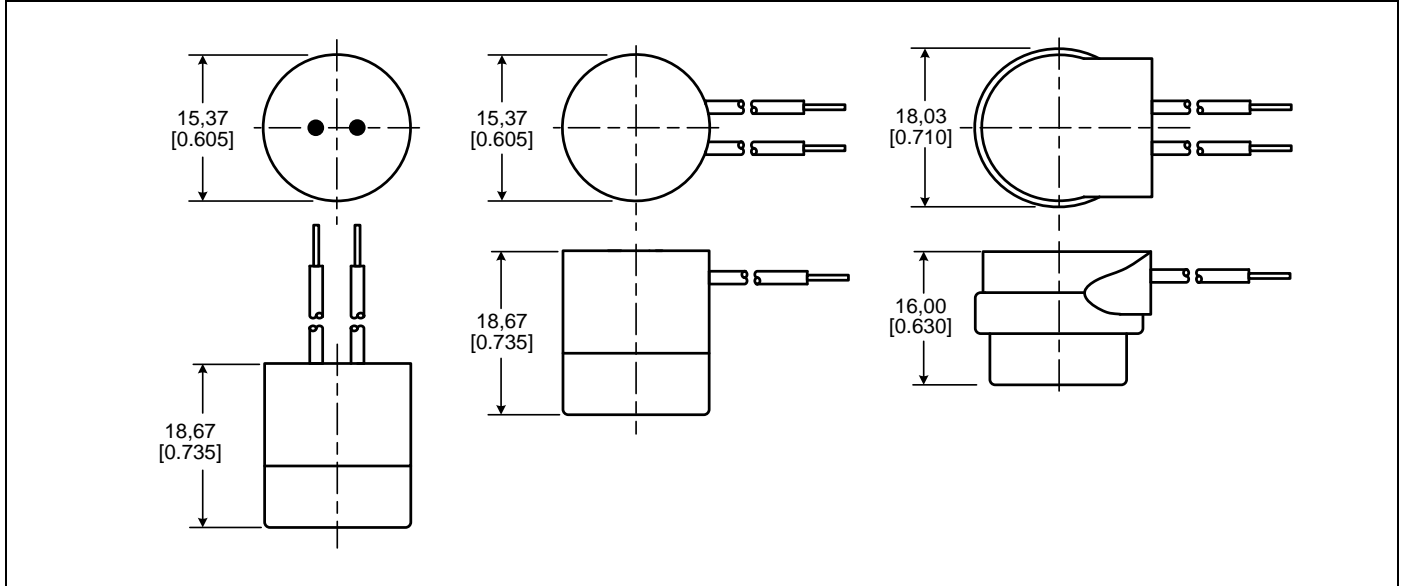

**Figure 30. Cap Studs Used on All Series**

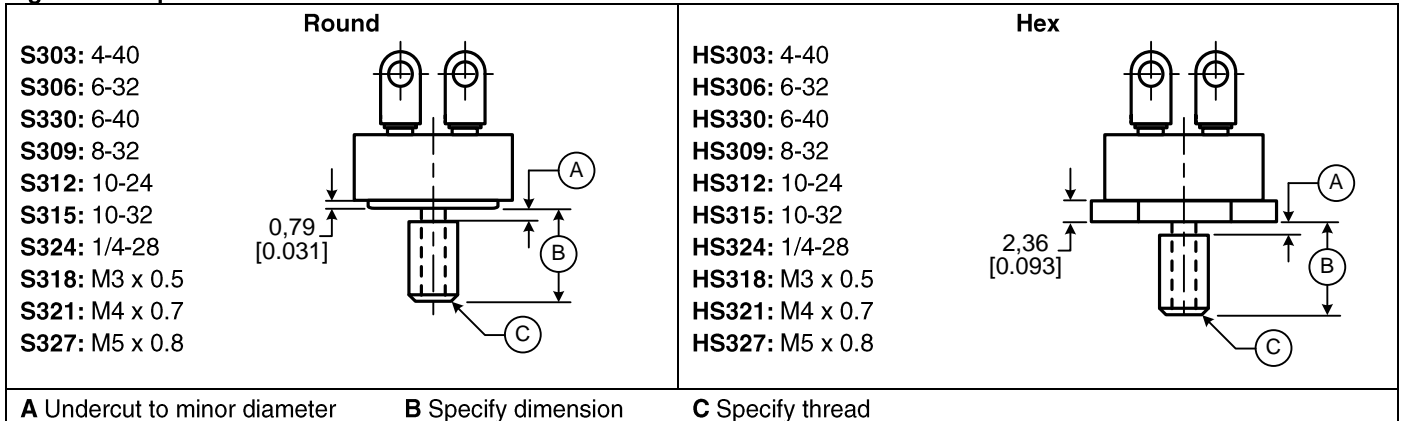

# Precision Thermostats

Figure 31. 3100U REDI-TEMP Series (See pages 12 for specifications and applications.)



Table 44. 3100U REDI-TEMP Series Open on Rise

Catalog Listing	Open Temp. °C [°F]	Open Tolerance °C [°F]	Close Temp. °C [°F]	Close Tolerance °C [°F]
3100U-3-1431	4 [40]	±3 [±5]	-7 [20]	±3 [±5]
3100U-3-1432	10 [50]	±3 [±5]	-1 [30]	±3 [±5]
3100U-3-1433	16 [60]	±3 [±5]	4 [40]	±3 [±5]
3100U-3-1434	21 [70]	±3 [±5]	10 [50]	±3 [±5]
3100U-3-1435	27 [80]	±3 [±5]	16 [60]	±3 [±5]
3100U-3-1436	32 [90]	±3 [±5]	21 [70]	±3 [±5]
3100U-3-1437	38 [100]	±3 [±5]	27 [80]	±3 [±5]
3100U-3-1438	43 [110]	±3 [±5]	32 [90]	±3 [±5]
3100U-3-1439	49 [120]	±3 [±5]	38 [100]	±3 [±5]
3100U-3-1440	54 [130]	±3 [±5]	43 [110]	±3 [±5]
3100U-3-1441	60 [140]	±3 [±5]	49 [120]	±3 [±5]
3100U-3-1446	88 [190]	±3 [±5]	77 [170]	±3 [±5]
3100U-3-1447	93 [200]	±3 [±5]	82 [180]	±3 [±5]
3100U-3-1448	99 [210]	±5 [±8]	85 [185]	±4 [±6]
3100U-3-1449	104 [220]	±5 [±8]	91 [195]	±4 [±6]
3100U-3-1450	110 [230]	±5 [±8]	96 [205]	±4 [±6]
3100U-3-1451	116 [240]	±5 ± [8]	102 [215]	±4 [±6]
3100U-3-1452	121 [250]	±5 [±8]	107 [225]	±4 [±6]

Table 45. 3100U REDI-TEMP Series Close on Rise

Catalog Listing	Close Temp. °C [°F]	Close Tolerance °C [°F]	Open Temp. °C [°F]	Open Tolerance °C [°F]
3100U-3-1453	4 [40]	±5 [±5]	-7 [20]	±3 [±5]
3100U-3-1454	10 [50]	±5 [±5]	-1 [30]	±3 [±5]
3100U-3-1455	16 [60]	±5 [±5]	4 [40]	±3 [±5]
3100U-3-1456	27 [80]	±5 [±5]	16 [60]	±3 [±5]
3100U-3-1457	38 [100]	±5 [±5]	27 [80]	±3 [±5]
3100U-3-1458	49 [120]	±5 [±5]	38 [100]	±3 [±5]
3100U-3-1459	60 [140]	±5 [±5]	49 [120]	±3 [±5]
3100U-3-1460	71 [160]	±5 [±5]	60 [140]	±3 [±5]
3100U-3-1461	82 [180]	±5 [±5]	71 [160]	±3 [±5]
3100U-3-1462	93 [200]	±5 [±5]	82 [180]	±3 [±5]
3100U-3-1463	104 [220]	±4 [±6]	91 [195]	±5 [±8]

Figure 32. 3600/3601 REDI-TEMP Series (See pages 4 and 5 for specifications and applications.)



Table 46. 3600/3601 REDI-TEMP Series Open on Rise

Catalog Listing	Open Temperature °C [°F]	Open Tolerance °C [°F]	Close Temperature °C [°F]	Close Tolerance °C [°F]	Minimum Differential Temperature °C [°F]
3600040010001	40.0 [104]	±5 [±8]	N/A	N/A	±2 [±3.6]
3600045010001	45.0 [113]	±5 [±8]	N/A	N/A	±2 [±3.6]
3600050010001	50.0 [122]	±5 [±8]	N/A	N/A	±2 [±3.6]
3600055010001	55.0 [131]	±5 [±8]	N/A	N/A	±5 [±8]
3600060010001	60.0 [140]	±5 [±8]	N/A	N/A	±5 [±8]
3600065010001	65.0 [149]	±5 [±8]	N/A	N/A	±5 [±8]
3600070010001	70.0 [158]	±5 [±8]	N/A	N/A	±5 [±8]
3600075010001	90.0 [194]	±5 [±8]	N/A	N/A	±5 [±8]
3600080010001	80.0 [176]	±5 [±8]	N/A	N/A	±5 [±8]
3600085010001	75.0 [167]	±5 [±8]	N/A	N/A	±7 [±12.6]
3600090010001	90.0 [194]	±5 [±8]	N/A	N/A	±7 [±12.6]
3600095010001	95.0 [203]	±5 [±8]	N/A	N/A	±7 [±12.6]
3600100010001	100.0 [212]	±5 [±8]	N/A	N/A	±7 [±12.6]

Table 47. 3600/3601 REDI-TEMP Series Close on Rise

Catalog Listing	Close Temperature °C [°F]	Close Tolerance °C [°F]	Open Temperature °C [°F]	Open Tolerance °C [°F]	Minimum Differential Temperature °C [°F]
3601040010001	40.0 [104]	±7 [±12.6]	N/A	N/A	±2 [±3.6]
3601045010001	45.0 [113]	±7 [±12.6]	N/A	N/A	±2 [±3.6]
3601050010001	50.0 [122]	±7 [±12.6]	N/A	N/A	±2 [±3.6]
3601055010001	55.0 [131]	±7 [±12.6]	N/A	N/A	±5 [±8]
3601060010001	60.0 [140]	±7 [±12.6]	N/A	N/A	±5 [±8]
3601065010001	65.0 [149]	±7 [±12.6]	N/A	N/A	±5 [±8]
3601070010001	70.0 [158]	±7 [±12.6]	N/A	N/A	±5 [±8]
3601075010001	90.0 [194]	±7 [±12.6]	N/A	N/A	±5 [±8]
3601080010001	80.0 [176]	±7 [±12.6]	N/A	N/A	±5 [±8]
3601085010001	75.0 [167]	±7 [±12.6]	N/A	N/A	±7 [±12.6]
3601090010001	90.0 [194]	±7 [±12.6]	N/A	N/A	±7 [±12.6]
3601095010001	95.0 [203]	±7 [±12.6]	N/A	N/A	±7 [±12.6]
3601100010001	100.0 [212]	±7 [±12.6]	N/A	N/A	±7 [±12.6]

## **WARNING**

### **PERSONAL INJURY**

DO NOT USE these products as safety or emergency stop devices or in any other application where failure of the product could result in personal injury.

**Failure to comply with these instructions could result in death or serious injury.**

### **WARRANTY/REMEDY**

Honeywell warrants goods of its manufacture as being free of defective materials and faulty workmanship. Honeywell's standard product warranty applies unless agreed to otherwise by Honeywell in writing; please refer to your order acknowledgement or consult your local sales office for specific warranty details. If warranted goods are returned to Honeywell during the period of coverage, Honeywell will repair or replace, at its option, without charge those items it finds defective. **The foregoing is buyer's sole remedy and is in lieu of all other warranties, expressed or implied, including those of merchantability and fitness for a particular purpose. In no event shall Honeywell be liable for consequential, special, or indirect damages.**

While we provide application assistance personally, through our literature and the Honeywell web site, it is up to the customer to determine the suitability of the product in the application.

Specifications may change without notice. The information we supply is believed to be accurate and reliable as of this printing. However, we assume no responsibility for its use.

## **WARNING**

### **MISUSE OF DOCUMENTATION**

- The information presented in this product sheet is for reference only. Do not use this document as a product installation guide.
- Complete installation, operation, and maintenance information is provided in the instructions supplied with each product.

**Failure to comply with these instructions could result in death or serious injury.**

### **SALES AND SERVICE**

Honeywell serves its customers through a worldwide network of sales offices, representatives and distributors. For application assistance, current specifications, pricing or name of the nearest Authorized Distributor, contact your local sales office or:

**E-mail:** [info.sc@honeywell.com](mailto:info.sc@honeywell.com)

**Internet:** [www.honeywell.com/sensing](http://www.honeywell.com/sensing)

#### **Phone and Fax:**

Asia Pacific +65 6355-2828  
+65 6445-3033 Fax  
Europe +44 (0) 1698 481481  
+44 (0) 1698 481676 Fax  
Latin America +1-305-805-8188  
+1-305-883-8257 Fax  
USA/Canada +1-800-537-6945  
+1-815-235-6847  
+1-815-235-6545 Fax

Sensing and Control  
Honeywell  
1985 Douglas Drive North  
Golden Valley, MN 55422  
[www.honeywell.com](http://www.honeywell.com)

009048-2-EN IL50 GLO Printed in USA  
April 2010  
Copyright © 2010 Honeywell International Inc. All rights reserved.

# **Honeywell**