



Heavy Duty Pressure Transducers

PX2 Series

1 bar to 70 bar | 100 kPa to 7 MPa |
15 psi to 1000 psi



Heavy Duty Pressure Transducers

Honeywell's PX2 Series Heavy Duty Pressure Transducer is a portfolio of highly configurable pressure sensors that use piezoresistive sensing technology with ASIC (Application Specific Integrated Circuit) signal conditioning in a stainless steel housing. The PX2 Series is fully calibrated and compensated for offset, sensitivity, temperature effects and non-linearity using the on-board ASIC. This provides a Total Error Band of $\pm 2\%$ over the operating temperature range of $-40\text{ }^{\circ}\text{C}$ to $125\text{ }^{\circ}\text{C}$ [$-40\text{ }^{\circ}\text{F}$ to $257\text{ }^{\circ}\text{F}$].

With thousands of possible configurations, the PX2 Series allows Honeywell to meet customer requirements and quickly provide samples. New standard configurations are regularly being added.

The PX2 Series is compatible with a variety of harsh media including brake fluid, common hydrofluorocarbon refrigerants, engine oil, tap water, hydraulic fluids, and compressed air. The wide operating temperature range, ingress protection up to IP69K, and 100 V/m radiated immunity allow for reliable performance in tough environments.

These transducers measure absolute, sealed gage, or vented gage pressure. The absolute versions have an internal vacuum reference and an output value proportional to absolute pressure, the sealed gage versions have an internal pressure reference of one atmosphere at sea level, and the vented gage versions measure pressure with respect to ambient pressure.

The PX2 Series is available in three pressure ranges:

- 1 bar to 70 bar
- 100 kPa to 7 MPa
- 15 psi to 1000 psi

All products are RoHS compliant and are designed and manufactured according to ISO 9001 standards.

What makes our transducers better?

- **Affordable:** Competitive product cost, over 60,000 standard configurations, and global application support
- **Available:** Wide selection of features and a short lead time for samples and production parts
- **High performance:** Small Total Error Band, fast response time, and longer life
- **High durability:** Environmentally tough, wide operating temperature range, and ability to withstand mechanical shock and vibration



Count on affordability and availability with these high performing, durable transducers.

AFFORDABLE • AVAILABLE • HIGH PERFORMANCE

Features and Benefits

Affordability minimizes your cost to produce.

COST EFFECTIVE*

The PX2 Series is a precise pressure measurement solution that optimizes system performance at a competitive cost.

DESIGNED FOR CONFIGURABILITY*

With over 60,000 standard configurations, the PX2 Series easily meets our customers' specific application needs.

APPLICATION EXPERTISE*

Knowledgeable application engineers are available to answer customers' specific design questions during the development of their product.

GLOBAL SUPPORT

Honeywell's global presence offers customers immediate product and application support throughout the development cycle, from design to global manufacturing.

Available feature-rich and fast.

WIDE SELECTION OF OPTIONS

Numerous standard or custom connectors, ports, pressure ranges and types, and output options include:

- Electrical connector types: Delphi Metri-Pack 150 (UL 94 HB or V-0 options), Micro M12, DIN, Deutsch, or cable harness (1 m, 2 m, 3 m, or 5 m).
- Pressure port types: 7/16-20 UNF 1/4 in 45° Flare Female Schrader (SAE J512), 7/16-20 UNF 45° Flare Male (SAE J513), 7/16-20 UNF 37° Flare Male (SAE J514), G1/4 (ISO 1179-3), G1/8 (ISO 1179-3), M12 x 1.5 (ISO 6149-3), 1/4-18 NPT, 1/8-27 NPT, 9/16-18 UNF, (SAE J1926-3), or 7/16-20 UNF (SAE J1926-3)
- Pressure range: 1 bar to 70 bar | 100 kPa to 7 MPa | 15 psi to 1000 psi.
- Pressure reference: Absolute, sealed gage, or vented gage.
- Output transfer function: Ratiometric, regulated, or current.
- Two available flame retardant options: UL 94 HB is standard on all electrical terminations, UL 94 V-0 is available upon request.

SHORT LEAD TIME

Due to the PX2 Series' configurability, customers can count on a quick response to prototypes. Additionally, dedicated teams and manufacturing processes ensure that product samples are shipped quickly to support your demanding product development cycle.

Dependable, consistent performance.

SMALL TOTAL ERROR BAND (TEB)

Honeywell specifies TEB, the most comprehensive, clear, and meaningful measurement that provides the transducer's true accuracy over a compensated temperature range of -40 °C to 125 °C [-40 °F to 257 °F] (see Figure 1).

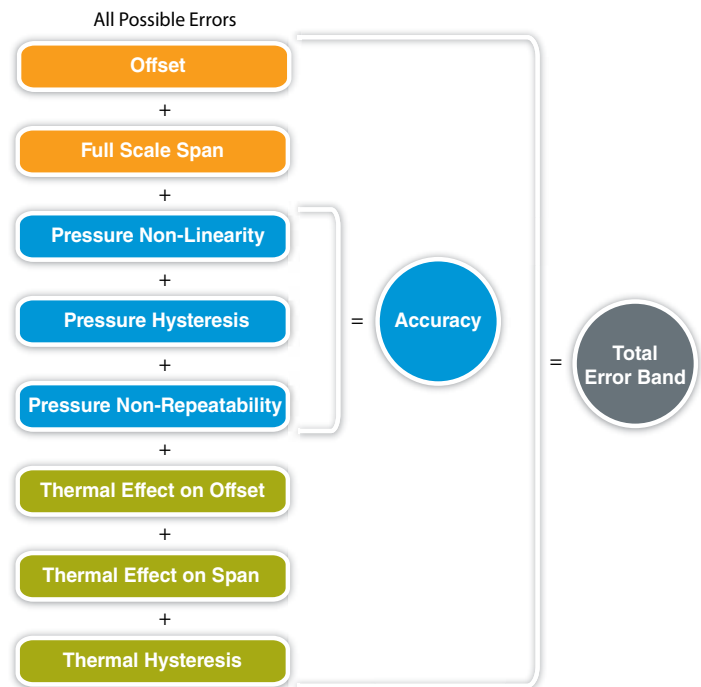

Figure 1: TEB For the PX2 Series

The PX2 Series' industry-leading TEB of $\pm 2\%$:

- Provides excellent transducer interchangeability due to minimal part-to-part variation in accuracy.
- Reduces the customers' need for individual transducer testing and calibration.
- Supports system accuracy and warranty requirements.

FAST RESPONSE TIME

A fast response time of <2 ms helps maximize system performance.

APPLICATION LIFE

A minimum 10 million cycles to operating pressure provides enhanced life in the application.

Features and Benefits

ENERGY EFFICIENT*

AC and AD output transfer functions offer a 3.3 V ratiometric output with a <7 ms turn on time, enabling the PX2 Series to be used when energy efficiency is a key requirement.

SIX SIGMA DESIGN STANDARDS*

Results in a high level of quality, performance, and consistency so that customers are assured that the transducer will perform to specification.

Durability improves output and endurance.

ENVIRONMENTALLY TOUGH

Compatibility with a wide variety of harsh media, up to IP69K ingress protection, and 100 V/m radiated immunity allow for use in tough environments. Sensor has overvoltage, reverse voltage, and short circuit protection.

WIDE OPERATING TEMPERATURE RANGE

A compensated operating temperature range of -40 °C to 125 °C [-40 °F to 257 °F] allows customers to design the same sensor into a variety of applications.

SHOCK AND VIBRATION RESISTANT

A mechanical shock rating of 100 G per MIL-STD-202F, Method 213B, Cond. F, and a vibration rating of 20 G sweep, 10 Hz to 2000 Hz, increase flexibility of use within the application.

GOOD EMC PROTECTION

Provides confidence that the transducer will not be damaged by environmental electromagnetic interference. Radiated immunity protection up to 100 V/m (ISO 11452-2) is available.

Potential Applications



INDUSTRIAL

HVAC/R

May be used to monitor system performance for proper environmental control of:

- Compressor inlet and outlet pressure
- Rooftop chillers
- Compressor rack rooms
- Refrigerant recovery systems
- Compressor oil pressure

AIR COMPRESSORS

May be used to monitor compressor performance and efficiency, specifically:

- Compressor inlet and outlet pressure
- Cooling water inlet and outlet pressure
- Compressor oil pressure
- Filter pressure drop



GENERAL

May be used to monitor air and fluid pressure in the following applications:

- Emissions monitoring
- Factory automation
- Flow and level
- Fluid power
- Foam dispensing
- Injection molding knock-out valves
- Lasers
- Laminating equipment
- Packaging equipment
- Pneumatics
- Pumps
- Solar energy
- Sprayers
- System pressure
- Valves

Heavy Duty Pressure Transducers

Table 1. Electrical Specifications

| Characteristic | Ratiometric Output | | | | Current Output | Regulated Output | | | |
|---|---|-----------|-----------|-----------|--------------------------------|-------------------------|-------------------|-------------------|-------------------|
| | Output Transfer Function Order Code ¹ | | | | | | | | |
| | AA | AB | AC | AD | CH | BC | BD | BE | BG |
| Output transfer function ¹ : | | | | | | | | | |
| null output value | 10% of Vs | 5% of Vs | 10% of Vs | 5% of Vs | 4 mA | 1 V | 0.25 V | 0.5 V | 1 V |
| full scale output value | 90% of Vs | 95% of Vs | 90% of Vs | 95% of Vs | 4 mA | 6 V | 10.25 V | 4.5 V | 5 V |
| full scale span (FSS) | 80% of Vs | 90% of Vs | 80% of Vs | 90% of Vs | 16 mA | 5 V | 10 V | 4 V | 4 V |
| operating supply voltage, min. (Vs) ² | 4.75 V | 4.5 V | 3.135 V | 3.135 V | 8 V | 9 V | 13 V | 8 V | 8 V |
| operating supply voltage, typ. (Vs) ² | 5 V | 5 V | 3.3 V | 3.3 V | — | — | — | — | — |
| operating supply voltage, max. (Vs) ² | 5.25 V | 5.5 V | 3.465 V | 3.465 V | 30 V ⁴ | 30 V ³ | 30 V ³ | 30 V ³ | 30 V ³ |
| Supply current (typ.) | 5 mA | | 4 mA | | — | 5.5 mA | | | |
| Output load (pull up or down) | | | | | | | | | |
| minimum | | | | | — | 2 kOhm | | | |
| maximum | | | | | (Vs - 8) x 50 Ohm ⁴ | — | | | |
| Absolute voltage ratings ⁵ : | | | | | | | | | |
| minimum ⁶ | | | | | -16 V | -16 V | | | |
| maximum ⁶ | | | | | 30 V | 30 V | | | |
| maximum applied to output pin (short circuit protection) ⁷ | | | | | — | 12 V | | | |
| EMC rating ⁸ : | | | | | | | | | |
| CE compliance: | | | | | | | | | |
| electrostatic discharge | ±4 kV contact, ±8 kV air per IEC 61000-4-2 | | | | | | | | |
| radiated immunity | 10 V/m (80 MHz to 1000 MHz) per IEC 61000-4-3 | | | | | | | | |
| fast transient burst | ±1 kV per IEC61000-4-4 | | | | | | | | |
| immunity to conducted disturbances | 3 V per IEC61000-4-6 | | | | | | | | |
| radiated emissions | 40 dB 30 MHz to 230 MHz; 47 dB 230 MHz to 1000 MHz per CISPR 11 | | | | | | | | |
| ISO 11452-2: | | | | | | | | | |
| radiated immunity | 100 V/m 200 MHz to 2 GHz | | | | | 20 V/m 200 MHz to 2 GHz | | | |

¹Output transfer function options are shown in the Nomenclature and Order Guide. (See Figure 4.)

²Transducer will not produce valid output when supply voltage is outside of operating range.

³Applies at 25 °C. See Figure 2 for Regulated Output Supply Voltage.

⁴Applies at 25 °C. See Figure 3 for Current Output Supply Voltage.

⁵Absolute maximum ratings are the extreme limits the device can withstand without damage to the product. Voltages above these ratings may cause permanent damage. Exposure to absolute maximum conditions for extended periods may degrade device reliability.

⁶Absolute voltage applies to potential across power and ground terminals.

⁷Short circuit protection between output pin and ground, and output pin and supply pin.

⁸All EMC ratings verified with the Delphi Metri-Pack 150 electrical connector type.

Figure 2. Regulated Output Supply Voltage

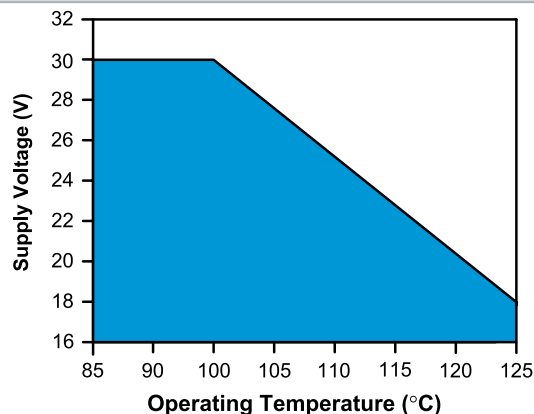
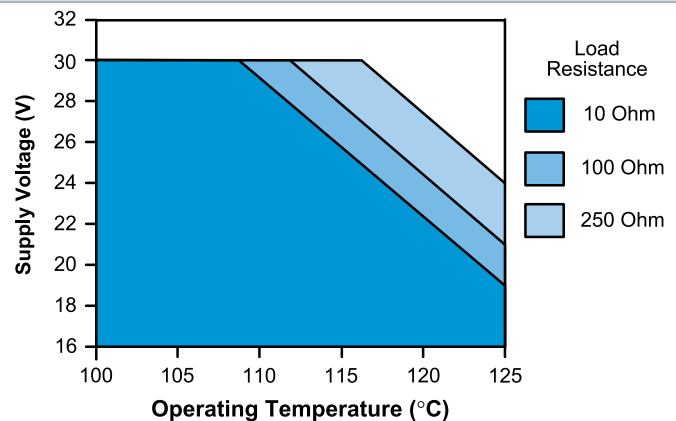

Figure 3. Current Output Supply Voltage



PX2 Series

Table 2. Performance Specifications¹

| Characteristic | Parameter |
|--|---|
| Operating temperature range ² | -40 °C to 125 °C [-40 °F to 257 °F] |
| Storage temperature range ³ | -40 °C to 125 °C [-40 °F to 257 °F] |
| Compensated temperature range ⁴ | -40 °C to 125 °C [-40 °F to 257 °F] |
| Overpressure minimum rating ⁵ | (See Table 3.) |
| Burst pressure minimum rating ⁶ | (See Table 3.) |
| Long term stability | ±0.5 %FSS ⁹ (1000 hr at 25 °C [77 °F]) |
| Accuracy ⁷ | ±0.25 %FSS ⁹ (See Figure 1.) |
| Offset error ⁸ | ±1 %FSS ⁹ |
| Total Error Band ¹⁰ | ±2 %FSS ⁹ (-40 °C to 125 °C [-40°F to 257 °F]) (See Figure 1.) |
| Response time ¹¹ | <2 ms |
| Turn on time ¹² | <7 ms |
| Life ¹³ | min. of 10 million cycles to operating pressure |

¹All specifications apply at 25 °C and under operating conditions unless otherwise noted.

²Operating Temperature Range: The temperature range over which the product will produce an output proportional to pressure but may not remain within the specified performance limits.

³Storage Temperature Range: The temperature range over which the product may safely be exposed without excitation or pressure applied. Under these conditions the product will remain in specification after excursion to any temperatures within this range. Exposure to temperatures outside this range may cause permanent damage to the product.

⁴Compensated Temperature Range: The temperature range (or ranges) over which the product will produce an output proportional to pressure within the specified performance limits.

⁵Overpressure: The absolute maximum rating for pressure which may be safely applied to the product for it to remain in specification once pressure is returned to the operating pressure range. Exposure to higher pressure may cause permanent damage to the product.

⁶Burst Pressure: The maximum pressure that may be applied to the product without causing escape of the pressure media. The product should not be expected to function after exposure to any pressure beyond the rated burst pressure. This rating is also the case burst rating of the product.

⁷Accuracy: The maximum deviation in output from a Best Fit Straight Line (BFSL) fitted to the output measured over the pressure range at 25 °C. Includes all errors due to pressure non-linearity, pressure hysteresis, and non-repeatability.

⁸Offset Error: the maximum deviation in the output signal obtained when the reference pressure is applied at 25 °C relative to the ideal transfer function.

⁹Full Scale Span (FSS): The algebraic difference between the output signal measured at the maximum (Pmax.) and minimum (Pmin.) limits of the pressure range.

¹⁰Total Error Band: The maximum deviation from the ideal transfer function over the entire compensated temperature and pressure range. Includes all errors due to offset, full scale span, pressure non-linearity, pressure hysteresis, repeatability, thermal effect on offset, thermal effect on span, and thermal hysteresis.

¹¹Response Time: The response time of the transducer is the maximum amount of time that the transducer will take for the transducer to output a change from 10% to 90% of full scale in response to a 0% to 100% full scale step input pressure range.

¹²Turn On Time: Duration from power applied until first valid output.

¹³Life may vary depending on the application in which transducer is used. Contact Honeywell Sales and Service for Mean Time to Failure (MTTF) data based on customer-specific usage profile.

Heavy Duty Pressure Transducers

Table 3. Pressure Ratings

| bar | | | kPa | | | MPa | | | psi | | |
|--------------------|---------------|----------------|--------------------|---------------|----------------|--------------------|---------------|----------------|--------------------|---------------|----------------|
| Operating Pressure | Over-pressure | Burst Pressure | Operating Pressure | Over-pressure | Burst Pressure | Operating Pressure | Over-pressure | Burst Pressure | Operating Pressure | Over-pressure | Burst Pressure |
| 1 | 5 | 8 | 100 | 500 | 800 | 1 | 3.1 | 5.1 | 15 | 70 | 115 |
| 1.6 | 5 | 8 | 160 | 1000 | 1700 | 1.6 | 5.2 | 8.6 | 30 | 150 | 250 |
| 2 | 10 | 17 | 250 | 1000 | 1700 | 2.5 | 6.9 | 10.3 | 50 | 250 | 400 |
| 2.5 | 10 | 17 | 400 | 1700 | 2700 | 4 | 6.9 | 10.3 | 100 | 450 | 750 |
| 4 | 17 | 27 | 600 | 3100 | 5100 | 4.6 | 6.9 | 10.3 | 150 | 450 | 750 |
| 6 | 31 | 51 | — | | | 6 | 13.8 | 20.6 | 200 | 750 | 1250 |
| 8 | 31 | 51 | — | | | 7 | 13.8 | 20.6 | 250 | 750 | 1250 |
| 10 | 31 | 51 | — | | | — | | | 300 | 1000 | 1500 |
| 16 | 52 | 86 | — | | | — | | | 500 | 1000 | 1500 |
| 25 | 69 | 103 | — | | | — | | | 600 | 1000 | 1500 |
| 34 | 69 | 103 | — | | | — | | | 667 | 1000 | 1500 |
| 40 | 69 | 103 | — | | | — | | | 750 | 1500 | 2250 |
| 46 | 69 | 103 | — | | | — | | | 800 | 1500 | 2250 |
| 60 | 138 | 206 | — | | | — | | | 850 | 2000 | 3000 |
| 70 | 138 | 206 | — | | | — | | | 1000 | 2000 | 3000 |

Table 4. Pressure Reference Types

| Pressure Reference | Description |
|--------------------------|---|
| Absolute | Output is proportional to the difference between applied pressure and a built-in fixed reference to vacuum (zero pressure), where the minimum operating pressure is set to absolute zero pressure (perfect vacuum). |
| Sealed gage ¹ | Output is proportional to the difference between applied pressure and a built-in fixed reference to 1 atmA, where the minimum operating pressure is set to 14.7 psiA (1 atmA). |
| Vented gage ² | Sensor measures pressure relative to ambient pressure. Output is proportional to the difference between applied pressure and atmospheric (ambient) pressure, where the minimum operating pressure is set to atmospheric pressure. |

¹Sealed gage option only available in pressure ranges at or above 100 psi.

²Vented gage option only available in pressure ranges between 100 psi and 667 psi.

Table 5. Mechanical Characteristics

| Characteristic | Parameter |
|---|--|
| Mechanical shock | 100 G per MIL-STD-202F, Method 213B, Cond. F (at 25 °C) |
| Vibration | 20 G sweep, 10 Hz to 2000 Hz (at 25 °C) |
| Enclosure rating | per electrical connector type selection (See Figure 5.) |
| Wetted materials: port substrate adhesives electronics | 304 stainless steel alumina ceramic epoxy glass, silicon |
| External materials: housing connector: UL 94 HB (standard) UL 94 V-0 (optional) cable jacket | 304 stainless steel PBT 30% GF, black PBT 30% GF, natural (beige) TPE |
| Installation torque | per pressure port type (See Figure 6.) |

PX2 Series

Figure 4. Nomenclature and Order Guide¹

| PX2 Series | A | N1 | XX ⁷ | 150P | A | BD | X ⁷ | |
|--|----------|--|-----------------|---|-----------------|----------------|----------------|---------------------------|
| | | | | | | | | Electrical Connector Type |
| PX2 Heavy Duty Pressure Transducer ¹ | A | Delphi Metri-Pack 150, Standard (UL 94 HB) ² (For UL 94 V-0 version, see order code J below.) | F1 | 7/16-20 UNF 1/4 in. 45° Flare Female Schrader (SAE J512) | 100K | 100kPa | A | AA |
| | B | Micro M12 (IEC 61076-2) | F2 | 7/16-20 UNF 45° Flare Male (SAE J513) | 160K | 160 kPa | S | AB |
| | C | DIN (EN 175301-803C) | F3 | 7/16-20 UNF 37° Flare Male (SAE J514) | 250K | 250 kPa | G | AC |
| | D | Deutsch (DTM04-3P) | G1 | G1/4 (ISO 1179-3) | 400K | 400 kPa | | AD |
| | E | Cable harness, 1 meter cable length ³ | G2 | G1/8 (ISO 1179-3) | 600K | 600 kPa | | BC |
| | F | Cable harness, 2 meter cable length ³ | M1 | M12 x 1.5 (ISO 6149-3) | 001G | 1 MPa | | BD |
| | G | Cable harness, 3 meter cable length ^{3,4} | N1 | 1/4-18 NPT | 1.6G | 1.6 MPa | | BE |
| | H | Cable harness, 5 meter cable length ^{3,4} | N2 | 1/8-27 NPT | 2.5G | 2.5 MPa | | BG |
| | J | Delphi Metri-Pack 150 (UL 94 V-0) ² | S1 | 9/16-18 UNF (SAE J1926-3) | 004G | 4 MPa | | CH |
| | | | S2 | 7/16-20 UNF (SAE J1926-3) | 4.6G | 4.6 MPa | | |
| | | | | 040B | 40 bar | | | |
| | | | | 046B | 46 bar | | | |
| | | | | 060B | 60 bar | | | |
| | | | | 070B | 70 bar | | | |
| | | | | 015P | 15 psi | | | |
| | | | | 030P | 30 psi | | | |
| | | | | 050P | 50 psi | | | |
| | | | | 100P | 100 psi | | | |
| | | | | 150P | 150 psi | | | |
| | | | | 200P | 200 psi | | | |
| | | | | 250P | 250 psi | | | |
| | | | | 300P | 300 psi | | | |
| | | | | 500P | 500 psi | | | |
| | | | | 600P | 600 psi | | | |
| | | | | 667P | 667 psi | | | |
| | | | | 750P | 750 psi | | | |
| | | | | 01KP | 1000 psi | | | |

¹Not all catalog listing combinations are available. Custom products are available. Please contact Honeywell.

²Mating connectors available from Honeywell are 3685301 (1 m cable length) and 3685302 (3 m cable length).

³Three-wire cable is required for ratiometric and regulated outputs; two-wire cable is required for current output.

⁴Three meter and five meter cables are only available with Output Transfer Function CH = Current, 4 mA to 20 mA.

⁵Sealed gage option only available in pressure ranges at or above 100 psi.

⁶Vented gage option only available in pressure ranges between 100 psi and 667 psi (not available on cable harness configurations).

⁷Reserved for future use.

Heavy Duty Pressure Transducers

Figure 5. Electrical Connector Type Dimensions (For reference only: mm/[in].)

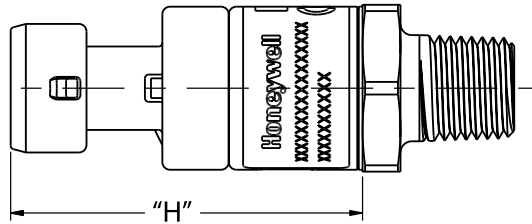

| A Delphi Metri-Pack 150, Standard (UL 94 HB) | | | B Micro M12 (IEC 61076-2) | | | C DIN (EN 175301-803C) | | |
|--|----------------|----------------|---|----------------|----------------|--|----------------|----------------|
| J Delphi Metri-Pack 150 (UL 94 V-0) | | | | | | | | |
| Connector: DELPHI 12078088 Mating Connector: DELPHI 12110192 IP Rating¹: IP65 (all versions) | | | Connector: IEC 61076-2-101 Mating Connector: 4 POS TYPE D IP Rating¹: IP65/IP67 (absolute, sealed gage versions) IP65 (vented gage versions) | | | Connector: EN 175301-803C Mating Connector: EN 175301-803C DIN 43650C 8MM IP Rating¹: IP65 (all versions) | | |
| Pin | Voltage Output | Current Output | Pin | Voltage Output | Current Output | Pin | Voltage Output | Current Output |
| A | GND | RTN | 1 | V+ | supply | 1 | GND | RTN |
| B | V+ | supply | 3 | GND | RTN | 2 | V+ | supply |
| C | Vout | NC | 4 | Vout | NC | 3 | Vout | NC |
| | | | | | | PE | NC | NC |

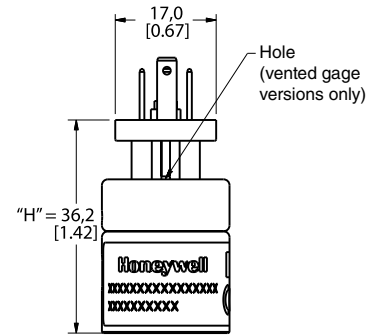
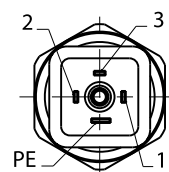
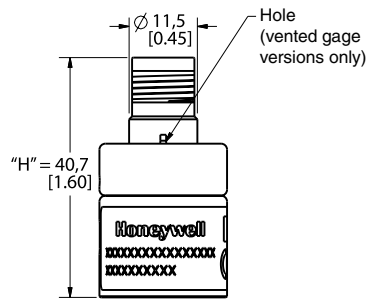
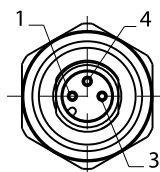
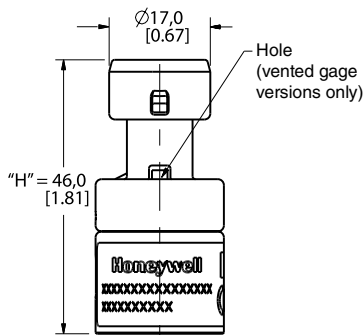
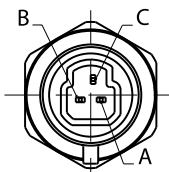

¹IP rating is determined by the electrical connection chosen.

PX2 Series

Figure 5. Electrical Connector Type Dimensions (continued)

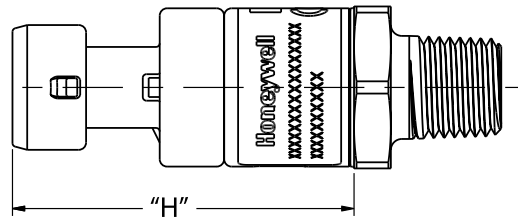

| | |
|-----------------------------------|--|
| D Deutsch (DTM04-3P) | E Cable Harness, 1 Meter ² F Cable Harness, 2 Meter ² G Cable Harness, 3 Meter ^{2,3} H Cable Harness, 5 Meter ^{2,3} |
|-----------------------------------|--|

Connector: Deutsch DTM04-3P
Mating Connector: DTM06-3S
IP Rating¹: IP65, IP67, IP69K (absolute, sealed gage versions)
 IP65 (vented gage versions)

Connector: 24 AWG with TPE Jacket
Mating Connector: Flying leads
IP Rating¹: IP65, IP67, IP69K (absolute, sealed gage versions)

| Pin | Voltage Output | Current Output | Wire Color | Voltage Output | Wire Color | Current Output |
|-----|----------------|----------------|------------|----------------|------------|----------------|
| 1 | GND | RTN | red | V+ | red | supply |
| 2 | Vout | NC | black | GND | black | RTN |
| 3 | V+ | supply | white | Vout | | |

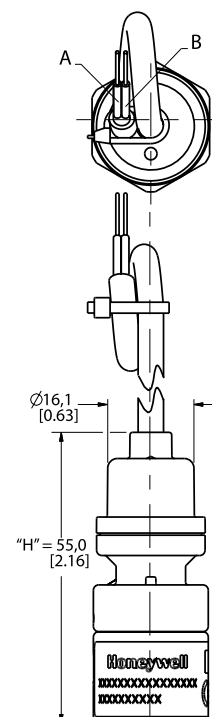
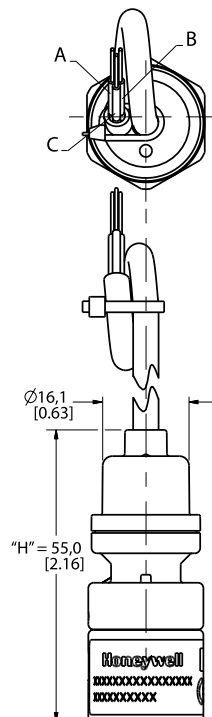
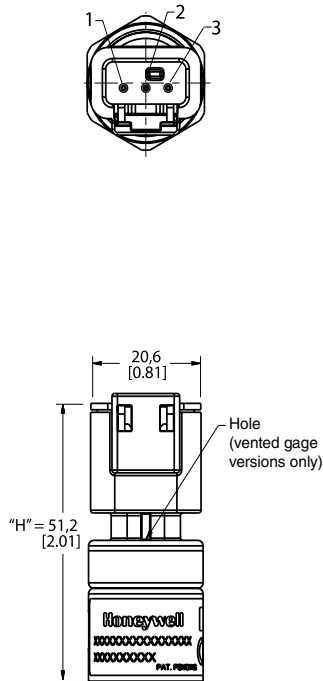

¹IP rating is determined by the electrical connector type chosen.

²Three-wire cable is required for ratiometric and regulated outputs; two wire cable is required for current output.

³Three meter and five meter cables are only available with Output Transfer Function **CH** = Current, 4 mA to 20 mA.

Heavy Duty Pressure Transducers

Figure 6. Pressure Port Type Dimensions (For reference only: mm/[in].)¹

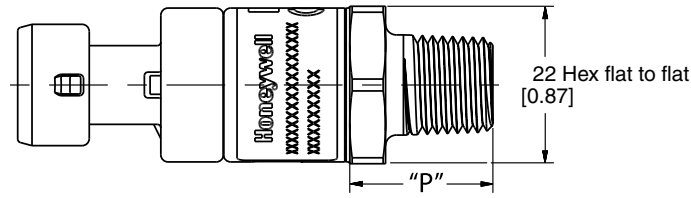

| | |
|--|---|
| <p>F1 7/16-20 UNF 1/4 in 45° Flare Female Schrader (SAE J512)</p> <p>Seal: 45° cone Mating geometry: SAE J512 Installation torque²: 17 N m [12.5 ft-lb]</p> | <p>F2 7/16-20 UNF 45° Flare Male (SAE J513)</p> <p>Seal: 45° cone Mating geometry: SAE J513 Installation torque²: 1/4 Turn from finger tight</p> |
| <p>F3 7/16-20 UNF 37° Flare Male (SAE J514)</p> <p>Seal^{3,4}: 37° cone Mating Geometry: SAE J514 Installation Torque²: 16 N m [11.8 ft-lb]</p> | <p>G1 G1/4 (ISO 1179-3)</p> <p>Seal^{3,4}: O-ring Mating geometry: ISO 1179-1 Installation torque²: 50 N m [38.9 ft-lb]</p> |
| <p>G2 G1/8 (ISO 1179-3)</p> <p>Seal^{3,4}: O-ring Mating geometry: ISO 1179-1 Installation torque²: 25 N m [18.4 ft-lb]</p> | <p>M1 M12 X 1.5 (ISO 6149-3)</p> <p>Seal^{3,3}: O-ring Mating geometry: ISO 6149-1 Installation torque²: 25 N m [18.4 ft-lb]</p> |
| <p>N1 1/4-18 NPT</p> <p>Seal: pipe thread Mating geometry: ANSI B1.20.1 Installation torque²: 2 to 3 turns from finger tight</p> | <p>N2 1/8-27 NPT</p> <p>Seal: pipe thread Mating geometry: ANSI B1.20.1 Installation torque²: 2 to 3 turns from finger tight</p> |
| <p>S1 9/16-18 UNF (SAE J1926-3)</p> <p>Seal^{3,4}: O-ring Mating geometry: SAE J1926-1 Installation torque²: 30 N m [22.1 ft-lb]</p> | <p>S2 7/16-20 UNF (SAE J1926-3)</p> <p>Seal^{3,4}: O-ring Mating geometry: SAE J1926-1 Installation torque²: 18 N m [12.3 ft-lb]</p> |

¹See **CAUTION** on back page.

²Straight thread maximum torque is validated to 150% of installation torque.

³Seals for pressure port type order codes **S1**, **S2**, **M1**, **G1** and **G2** are included and assembled to the sensors.

⁴O-ring material is nitrile 70 durometer -30 °C to 125 °C [-22 °F to 257 °F].

CAUTION

PRODUCT DAMAGE

- Ensure torque specifications are determined for the specific application. Values provided are for reference only. NPT ports are not specified with torque values. Correct installation is based on the number of Turns From Finger Tight (TFFT). (Mating materials and thread sealants can result in significantly different torque values from one application to the next.)
- When using NPT ports in stainless steel manifolds, use a thread sealant with anti-seize properties to prevent thread galling. Ensure the sealant is rated for the application.
- Use appropriate tools (such as an open ended wrench or deep well socket) to install transducers.
- Always hand-start transducers into the hole to prevent cross threading and damage

Failure to comply with these instructions may result in product damage.

⚠ WARNING

PERSONAL INJURY

DO NOT USE these products as safety or emergency stop devices or in any other application where failure of the product could result in personal injury.

Failure to comply with these instructions could result in death or serious injury.

⚠ WARNING

MISUSE OF DOCUMENTATION

- The information presented in this datasheet is for reference only. Do not use this document as a product installation guide.
- Complete installation, operation, and maintenance information is provided in the instructions supplied with each product.

Failure to comply with these instructions could result in death or serious injury.

ADDITIONAL INFORMATION

The following associated literature is available at sensing.honeywell.com:

- Product line guide
- Product part listing/nomenclature tree
- Product range guide
- Technical Information:
 - Total Error Band Specification for Honeywell Heavy Duty Pressure Transducers, PX2 Series
- Application information
- Product installation instructions

Find out more

Honeywell serves its customers through a worldwide network of sales offices, representatives and distributors. For application assistance, current specifications, pricing or name of the nearest Authorized Distributor, contact your local sales office.

To learn more about Honeywell's sensing and control products,

call **+1-815-235-6847** or

1-800-537-6945,

visit **sensing.honeywell.com**, or e-mail inquiries to

info.sc@honeywell.com

Sensing and Control
Honeywell
1985 Douglas Drive North
Golden Valley, MN 55422
honeywell.com

WARRANTY/REMEDY

Honeywell warrants goods of its manufacture as being free of defective materials and faulty workmanship. Honeywell's standard product warranty applies unless agreed to otherwise by Honeywell in writing; please refer to your order acknowledgement or consult your local sales office for specific warranty details. If warranted goods are returned to Honeywell during the period of coverage, Honeywell will repair or replace, at its option, without charge those items it finds defective. **The foregoing is buyer's sole remedy and is in lieu of all other warranties, expressed or implied, including those of merchantability and fitness for a particular purpose. In no event shall Honeywell be liable for consequential, special, or indirect damages.**

While we provide application assistance personally, through our literature and the Honeywell website, it is up to the customer to determine the suitability of the product in the application.

Specifications may change without notice. The information we supply is believed to be accurate and reliable as of this printing. However, we assume no responsibility for its use.

Honeywell