

Standard Power MOSFET

IXTH / IXTM 5N100
IXTH / IXTM 5N100A

| V_{DSS} | I_{D25} | $R_{DS(on)}$ |
|-----------|-----------|--------------|
| 1000 V | 5 A | 2.4 Ω |
| 1000 V | 5 A | 2.0 Ω |

N-Channel Enhancement Mode

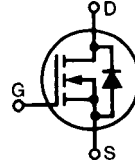

| Symbol | Test Conditions | Maximum Ratings | |
|---|---|-----------------------------|------------------|
| V_{DSS} | $T_J = 25^\circ\text{C}$ to 150°C | 1000 | V |
| V_{DGR} | $T_J = 25^\circ\text{C}$ to 150°C ; $R_{GS} = 1\text{ M}\Omega$ | 1000 | V |
| V_{GS} | Continuous | ± 20 | V |
| V_{GSM} | Transient | ± 30 | V |
| I_{D25} | $T_C = 25^\circ\text{C}$ | 5 | A |
| I_{DM} | $T_C = 25^\circ\text{C}$, pulse width limited by T_{JM} | 20 | A |
| P_D | $T_C = 25^\circ\text{C}$ | 180 | W |
| T_J | | -55 ... +150 | $^\circ\text{C}$ |
| T_{JM} | | 150 | $^\circ\text{C}$ |
| T_{stg} | | -55 ... +150 | $^\circ\text{C}$ |
| M_d | Mounting torque | 1.13/10 | Nm/lb.in. |
| Weight | | TO-204 = 18 g, TO-247 = 6 g | |
| Maximum lead temperature for soldering 1.6 mm (0.062 in.) from case for 10 s | | 300 | $^\circ\text{C}$ |

TO-247 AD (IXTH)

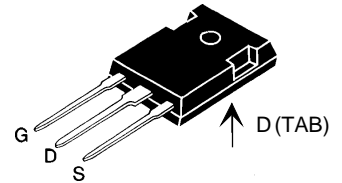

TO-204 AA (IXTM)

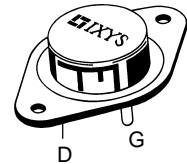

G = Gate, D = Drain,
S = Source, TAB = Drain

Features

- International standard packages
- Low $R_{DS(on)}$ HDMOS™ process
- Rugged polysilicon gate cell structure
- Low package inductance (< 5 nH)
 - easy to drive and to protect
- Fast switching times

Applications

- Switch-mode and resonant-mode power supplies
- Motor controls
- Uninterruptible Power Supplies (UPS)
- DC choppers

Advantages

- Easy to mount with 1 screw (TO-247) (isolated mounting screw hole)
- Space savings
- High power density

| Symbol | Test Conditions | Characteristic Values ($T_J = 25^\circ\text{C}$, unless otherwise specified) | | |
|--------------|---|---|------|------------------------------|
| | | min. | typ. | max. |
| V_{DSS} | $V_{GS} = 0\text{ V}$, $I_D = 3\text{ mA}$ | 1000 | | V |
| $V_{GS(th)}$ | $V_{DS} = V_{GS}$, $I_D = 250\text{ }\mu\text{A}$ | 2 | | 4.5 V |
| I_{GSS} | $V_{GS} = \pm 20\text{ V}_{DC}$, $V_{DS} = 0$ | | | $\pm 100\text{ nA}$ |
| I_{DSS} | $V_{DS} = 0.8 \cdot V_{DSS}$ $V_{GS} = 0\text{ V}$ | | | 250 μA 1 mA |
| $R_{DS(on)}$ | $V_{GS} = 10\text{ V}$, $I_D = 0.5 I_{D25}$ Pulse test, $t \leq 300\text{ }\mu\text{s}$, duty cycle $d \leq 2\%$ | | | 2.4 Ω 2.0 Ω |

| Symbol | Test Conditions | Characteristic Values ($T_J = 25^\circ\text{C}$, unless otherwise specified) | | |
|--------------|---|---|------|--------|
| | | min. | typ. | max. |
| g_{fs} | $V_{DS} = 10\text{ V}; I_D = 0.5 \cdot I_{D25}$, pulse test | 4 | 6 | S |
| C_{iss} | $V_{GS} = 0\text{ V}, V_{DS} = 25\text{ V}, f = 1\text{ MHz}$ | | 2600 | pF |
| C_{oss} | | | 180 | pF |
| C_{rss} | | | 45 | pF |
| $t_{d(on)}$ | $V_{GS} = 10\text{ V}, V_{DS} = 0.5 \cdot V_{DSS}, I_D = 0.5 I_{D25}$ $R_G = 4.7\ \Omega$, (External) | | 35 | 100 ns |
| t_r | | | 20 | 50 ns |
| $t_{d(off)}$ | | | 100 | 200 ns |
| t_f | | | 30 | 80 ns |
| $Q_{g(on)}$ | $V_{GS} = 10\text{ V}, V_{DS} = 0.5 \cdot V_{DSS}, I_D = 0.5 I_{D25}$ | | 88 | 130 nC |
| Q_{gs} | | | 21 | 30 nC |
| Q_{gd} | | | 38 | 70 nC |
| R_{thJC} | | | 0.7 | K/W |
| R_{thCK} | | 0.25 | | K/W |

Source-Drain Diode

| Symbol | Test Conditions | Characteristic Values ($T_J = 25^\circ\text{C}$, unless otherwise specified) | | |
|----------|---|---|------|-------|
| | | min. | typ. | max. |
| I_S | $V_{GS} = 0\text{ V}$ | | | 5 A |
| I_{SM} | Repetitive; pulse width limited by T_{JM} | | | 20 A |
| V_{SD} | $I_F = I_S, V_{GS} = 0\text{ V}$, Pulse test, $t \leq 300\ \mu\text{s}$, duty cycle $d \leq 2\%$ | | | 1.5 V |
| t_{rr} | $I_F = I_S, -di/dt = 100\text{ A}/\mu\text{s}, V_R = 100\text{ V}$ | 900 | | ns |

TO-247 AD (IXTH) Outline

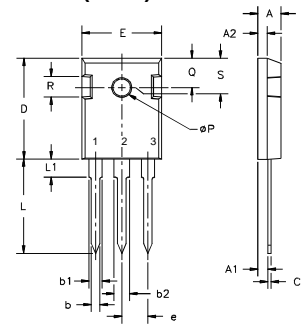

Terminals: 1 - Gate 2 - Drain
3 - Source Tab - Drain

| Dim. | Millimeter | | Inches | |
|----------------|------------|-------|--------|-------|
| | Min. | Max. | Min. | Max. |
| A | 4.7 | 5.3 | .185 | .209 |
| A ₁ | 2.2 | 2.54 | .087 | .102 |
| A ₂ | 2.2 | 2.6 | .059 | .098 |
| b | 1.0 | 1.4 | .040 | .055 |
| b ₁ | 1.65 | 2.13 | .065 | .084 |
| b ₂ | 2.87 | 3.12 | .113 | .123 |
| C | .4 | .8 | .016 | .031 |
| D | 20.80 | 21.46 | .819 | .845 |
| E | 15.75 | 16.26 | .610 | .640 |
| e | 5.20 | 5.72 | 0.205 | 0.225 |
| L | 19.81 | 20.32 | .780 | .800 |
| L1 | | 4.50 | | .177 |
| ØP | 3.55 | 3.65 | .140 | .144 |
| Q | 5.89 | 6.40 | 0.232 | 0.252 |
| R | 4.32 | 5.49 | .170 | .216 |
| S | 6.15 | BSC | 242 | BSC |

TO-204AA (IXTM) Outline

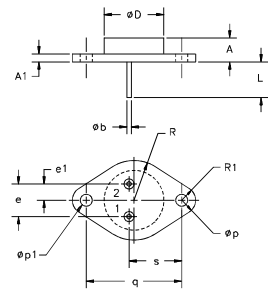

Pins 1 - Gate 2 - Source
Case - Drain

| Dim. | Millimeter | | Inches | |
|-----------------|------------|-------|--------|-------|
| | Min. | Max. | Min. | Max. |
| A | 6.4 | 11.4 | .250 | .450 |
| A ₁ | | 3.42 | | .135 |
| Øb | .97 | 1.09 | .038 | .043 |
| ØD | | 22.22 | | .875 |
| e | 10.67 | 11.17 | .420 | .440 |
| e ₁ | 5.21 | 5.71 | .205 | .225 |
| L | 7.93 | | .312 | |
| Øp | 3.84 | 4.19 | .151 | .165 |
| Øp ₁ | 3.84 | 4.19 | .151 | .165 |
| q | | 30.15 | | 1.187 |
| R | | 13.33 | | .525 |
| R ₁ | | 4.77 | | .188 |
| s | 16.64 | 17.14 | .655 | .675 |

Fig. 1 Output Characteristics

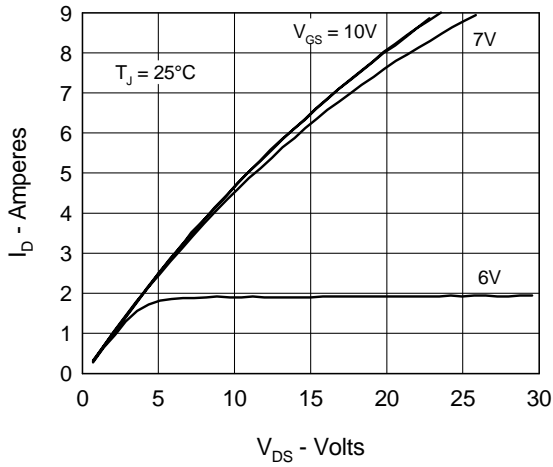

Fig. 2 Input Admittance

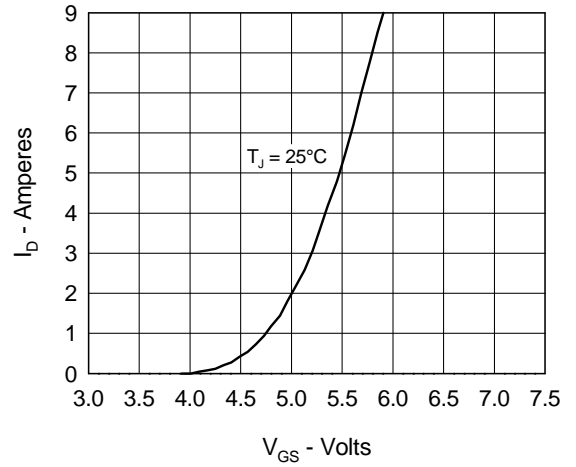

Fig. 3 $R_{DS(on)}$ vs. Drain Current

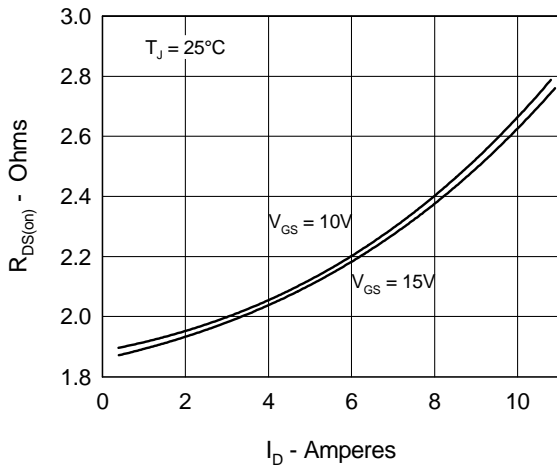

Fig. 4 Temperature Dependence of Drain to Source Resistance

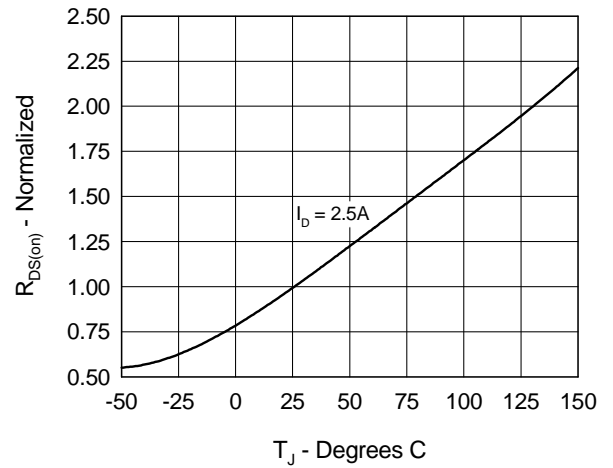

Fig. 5 Drain Current vs. Case Temperature

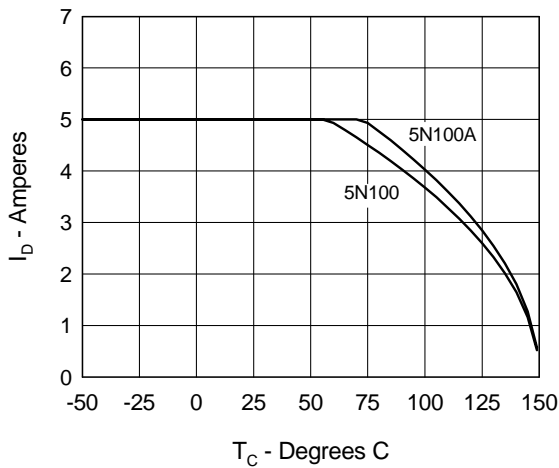

Fig. 6 Temperature Dependence of Breakdown and Threshold Voltage

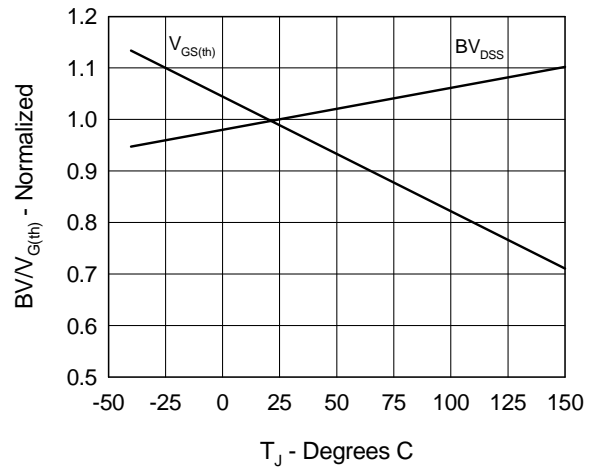

Fig.7 Gate Charge Characteristic Curve

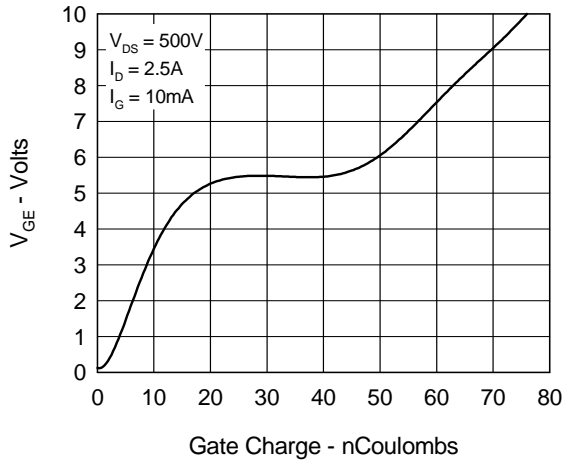

Fig.8 Forward Bias Safe Operating Area

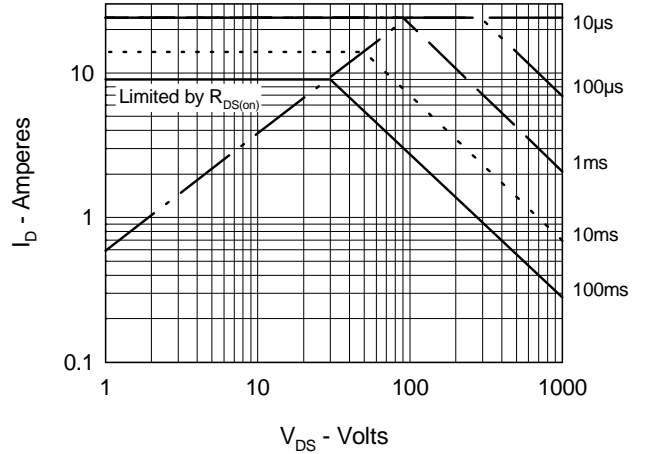

Fig.9 Capacitance Curves

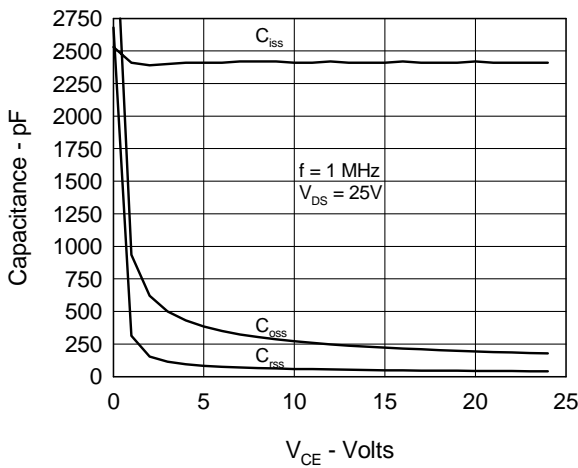

Fig.10 Source Current vs. Source to Drain Voltage

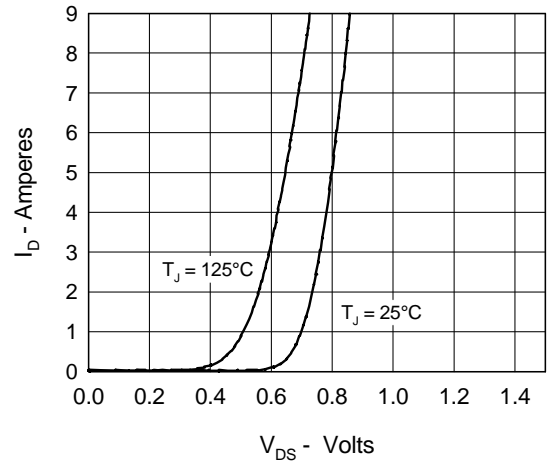

Fig.11 Transient Thermal Impedance

