

# HiPerFAST™ IGBT with Diode

Optimized for 10-25 kHz  
hard switching and up to  
100 kHz resonant switching

**IXGK 60N60B2D1**  
**IXGX 60N60B2D1**

$V_{CES} = 600 \text{ V}$   
 $I_{C25} = 75 \text{ A}$   
 $V_{CE(sat)} < 1.8 \text{ V}$   
 $t_{fi(typ)} = 100 \text{ ns}$

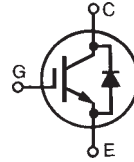

Symbol	Test Conditions	Maximum Ratings	
$V_{CES}$	$T_J = 25^\circ\text{C to } 150^\circ\text{C}$	600	V
$V_{CGR}$	$T_J = 25^\circ\text{C to } 150^\circ\text{C}; R_{GE} = 1 \text{ M}\Omega$	600	V
$V_{GES}$	Continuous	$\pm 20$	V
$V_{GEM}$	Transient	$\pm 30$	V
$I_{C25}$	$T_C = 25^\circ\text{C}$ (limited by leads)	75	A
$I_{C110}$	$T_C = 110^\circ\text{C}$	60	A
$I_{CM}$	$T_C = 25^\circ\text{C}, 1 \text{ ms}$	300	A
<b>SSOA</b> <b>(RBSOA)</b>	$V_{GE} = 15 \text{ V}, T_{VJ} = 125^\circ\text{C}, R_G = 10 \Omega$ Clamped inductive load @ $V_{CE} \leq 600 \text{ V}$	$I_{CM} = 150$	A
$P_C$	$T_C = 25^\circ\text{C}$	500	W
$T_J$		-55 ... +150	$^\circ\text{C}$
$T_{JM}$		150	$^\circ\text{C}$
$T_{stg}$		-55 ... +150	$^\circ\text{C}$
$M_d$	Mounting torque, TO-264	1.13/10 Nm/lb.in.	
<b>Weight</b>	TO-264	10	g
	PLUS247	6	g
Maximum lead temperature for soldering 1.6 mm (0.062 in.) from case for 10 s		300	$^\circ\text{C}$

TO-264 AA  
(IXGK)

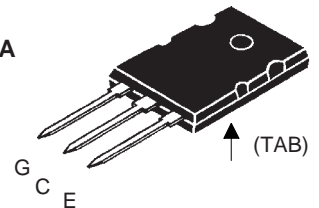

PLUS247  
(IXGX)

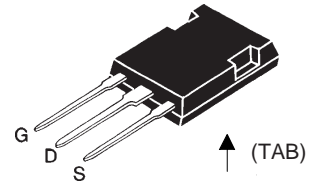

G = Gate      C = Collector  
E = Emitter    Tab = Collector

## Features

- Square RBSOA
- High current handling capability
- MOS Gate turn-on for drive simplicity
- Fast Recovery Epitaxial Diode (FRED) with soft recovery and low  $I_{RM}$

## Applications

- Switch-mode and resonant-mode power supplies
- Uninterruptible power supplies (UPS)
- DC choppers
- AC motor speed control
- DC servo and robot drives

## Advantages

- Space savings (two devices in one package)
- Easy to mount with 1 screw

Symbol	Test Conditions	Characteristic Values ( $T_J = 25^\circ\text{C}$ , unless otherwise specified)		
		Min.	Typ.	Max.
$V_{GE(th)}$	$I_C = 250 \mu\text{A}, V_{CE} = V_{GE}$	3.0		5.0
$I_{CES}$	$V_{CE} = V_{CES}$ $V_{GE} = 0 \text{ V}$ $T_J = 125^\circ\text{C}$			300 $\mu\text{A}$
				5 mA
$I_{GES}$	$V_{CE} = 0 \text{ V}, V_{GE} = \pm 20 \text{ V}$			$\pm 100 \text{ nA}$
$V_{CE(sat)}$	$I_C = 50 \text{ A}, V_{GE} = 15 \text{ V}$ Note 1			1.8

Symbol	Test Conditions	Characteristic Values ( $T_J = 25^\circ\text{C}$ , unless otherwise specified)			
		Min.	Typ.	Max.	
$g_{fs}$	$I_C = 50\text{ A}; V_{CE} = 10\text{ V}$ , Note 1	40	58	S	
$C_{ies}$	$V_{CE} = 25\text{ V}, V_{GE} = 0\text{ V}, f = 1\text{ MHz}$		3900	pF	
$C_{oes}$			340	pF	
$C_{res}$			100	pF	
$Q_g$	$I_C = 50\text{ A}, V_{GE} = 15\text{ V}, V_{CE} = 0.5 V_{CES}$		170	nC	
$Q_{ge}$			25	nC	
$Q_{gc}$			57	nC	
$t_{d(on)}$	<b>Inductive load, <math>T_J = 25^\circ\text{C}</math></b> $I_C = 50\text{ A}, V_{GE} = 15\text{ V}$ $V_{CE} = 400\text{ V}, R_G = R_{off} = 3.3\ \Omega$		28	ns	
$t_{ri}$			30	ns	
$t_{d(off)}$			160	270	ns
$t_{fi}$			100	170	ns
$E_{off}$			1.0	2.5	mJ
$t_{d(on)}$	<b>Inductive load, <math>T_J = 125^\circ\text{C}</math></b> $I_C = 50\text{ A}, V_{GE} = 15\text{ V}$ $V_{CE} = 400\text{ V}, R_G = R_{off} = 2.0\ \Omega$		28	ns	
$t_{ri}$			36	ns	
$E_{on}$			1.5	mJ	
$t_{d(off)}$			310	ns	
$t_{fi}$			240	ns	
$E_{off}$		2.8	mJ		
$R_{thJC}$		0.15	0.25	KW	
$R_{thCK}$				KW	

**Reverse Diode (FRED)**

Symbol	Test Conditions	Characteristic Values ( $T_J = 25^\circ\text{C}$ , unless otherwise specified)		
		min.	typ.	max.
$V_F$	$I_F = 60\text{ A}, V_{GE} = 0\text{ V}$ , Note 1			2.1 V
		$T_J = 150^\circ\text{C}$		1.4 V
$I_{RM}$	$I_F = 60\text{ A}, V_{GE} = 0\text{ V}, -di_F/dt = 100\text{ A}/\mu\text{s}$ $V_R = 100\text{ V}$			8.3 A
$t_{rr}$	$I_F = 1\text{ A}; -di/dt = 200\text{ A/ms}; V_R = 30\text{ V}$		35	ns
$R_{thJC}$				0.85 KW

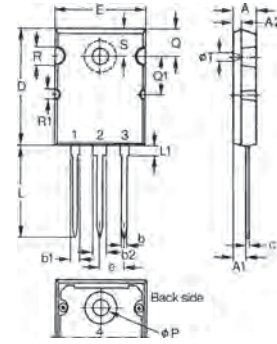
 Note 1: Pulse test,  $t \leq 300\ \mu\text{s}$ , duty cycle  $\leq 2\%$ 
**TO-264 AA Outline**

Dim.	Millimeter		Inches	
	Min.	Max.	Min.	Max.
A	4.82	5.13	.190	.202
A1	2.54	2.89	.100	.114
A2	2.00	2.10	.079	.083
b	1.12	1.42	.044	.056
b1	2.39	2.69	.094	.106
b2	2.90	3.09	.114	.122
c	0.53	0.83	.021	.033
D	25.91	26.16	1.020	1.030
E	19.81	19.96	.780	.786
e	5.46BSC		.215BSC	
J	0.00	0.25	.000	.010
K	0.00	0.25	.000	.010
L	20.32	20.83	.800	.820
L1	2.29	2.59	.090	.102
P	3.17	3.66	.125	.144
Q	6.07	6.27	.239	.247
Q1	8.38	8.69	.330	.342
R	3.81	4.32	.150	.170
R1	1.78	2.29	.070	.090
S	6.04	6.30	.238	.248
T	1.57	1.83	.062	.072

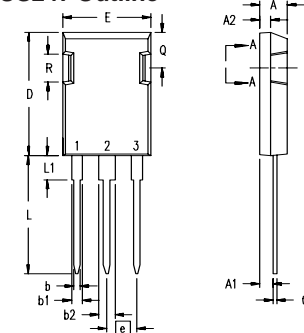
**PLUS247 Outline**

 Terminals: 1 - Gate  
 2 - Drain (Collector)  
 3 - Source (Emitter)  
 4 - Drain (Collector)

Dim.	Millimeter		Inches	
	Min.	Max.	Min.	Max.
A	4.83	5.21	.190	.205
A <sub>1</sub>	2.29	2.54	.090	.100
A <sub>2</sub>	1.91	2.16	.075	.085
b	1.14	1.40	.045	.055
b <sub>1</sub>	1.91	2.13	.075	.084
b <sub>2</sub>	2.92	3.12	.115	.123
C	0.61	0.80	.024	.031
D	20.80	21.34	.819	.840
E	15.75	16.13	.620	.635
e	5.45 BSC		.215 BSC	
L	19.81	20.32	.780	.800
L1	3.81	4.32	.150	.170
Q	5.59	6.20	.220	0.244
R	4.32	4.83	.170	.190

IXYS reserves the right to change limits, test conditions, and dimensions.

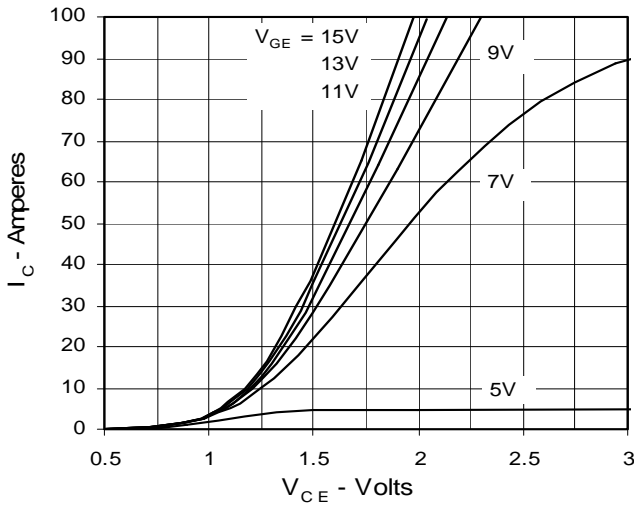
**Fig. 1. Output Characteristics**  
**@ 25 Deg. C**



**Fig. 2. Extended Output Characteristics**  
**@ 25 deg. C**

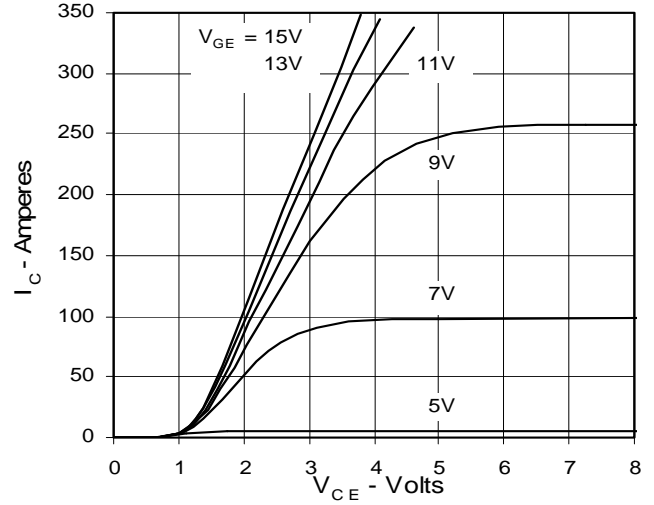

**Fig. 3. Output Characteristics**  
**@ 125 Deg. C**

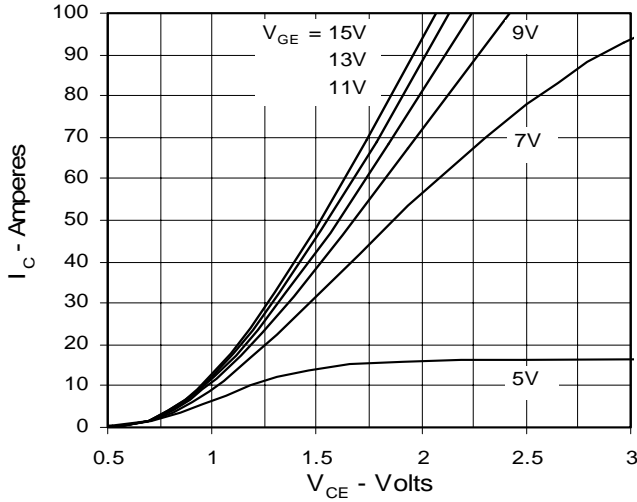

**Fig. 4. Dependence of  $V_{CE(sat)}$  on Temperature**

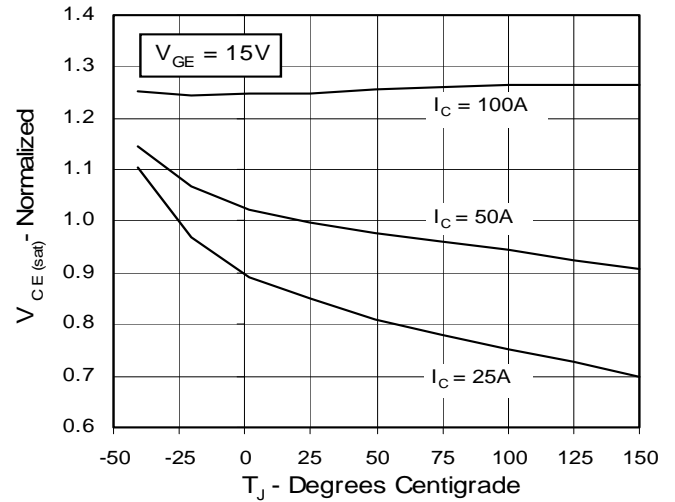

**Fig. 5. Collector-to-Emitter Voltage vs. Gate-to-Emmitter voltage**

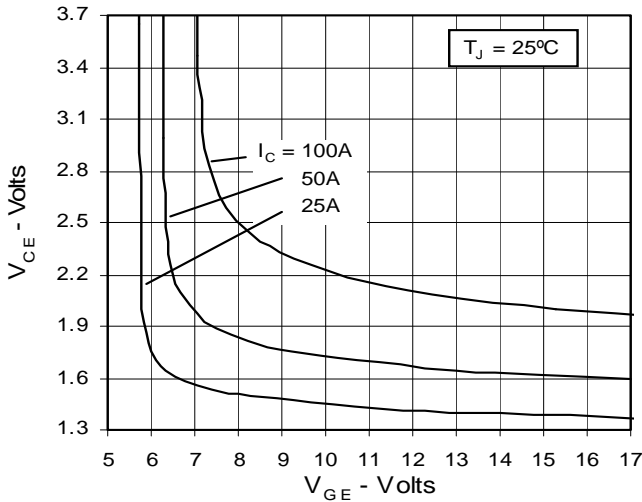

**Fig. 6. Input Admittance**

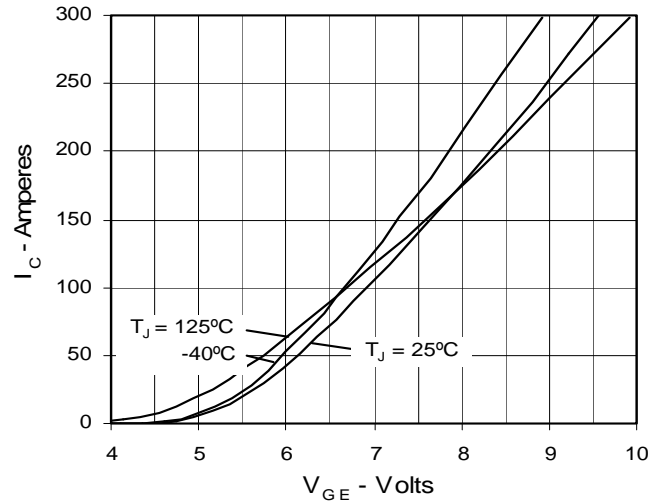

Fig. 7. Transconductance

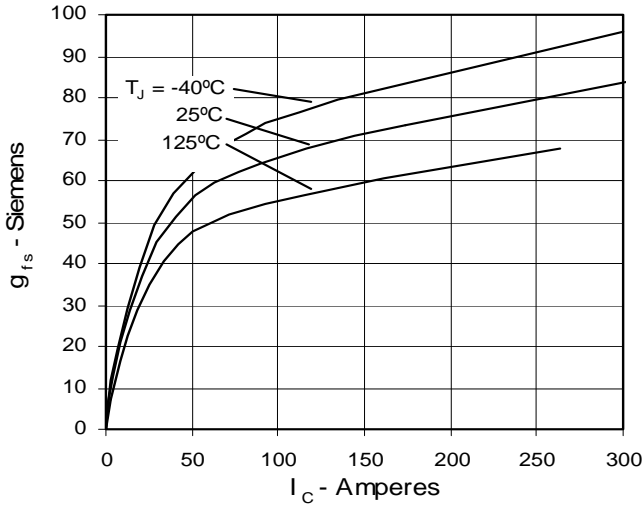

Fig. 8. Dependence of Turn-Off Energy on  $R_G$

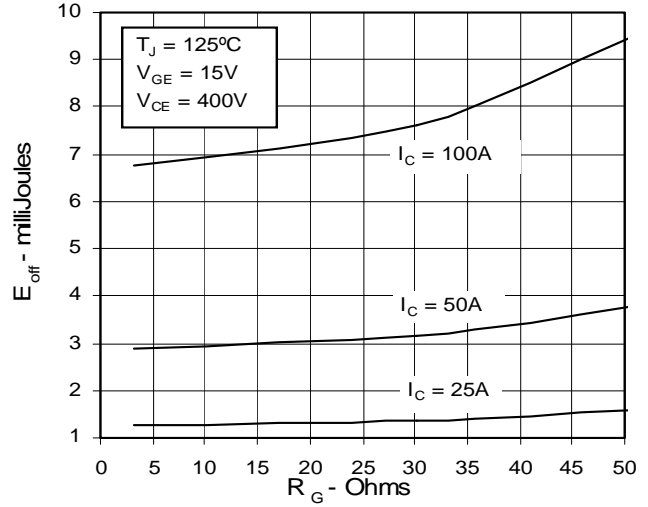

Fig. 9. Dependence of Turn-Off Energy on  $I_C$

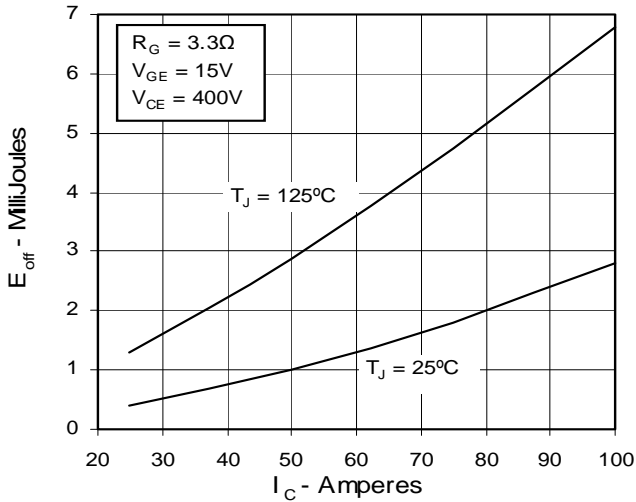

Fig. 10. Dependence of Turn-Off Energy on Temperature

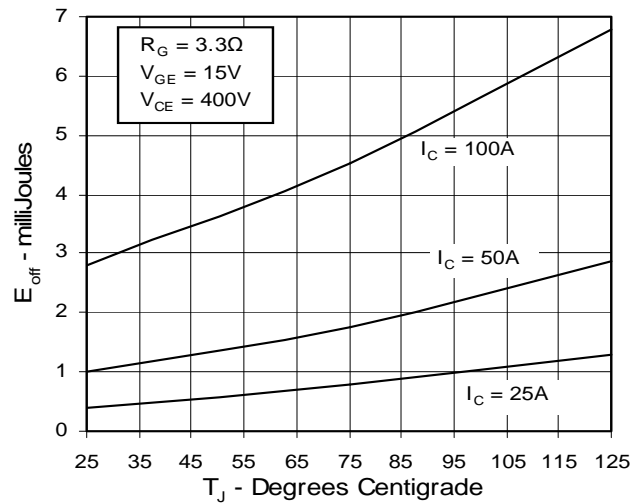

Fig. 11. Dependence of Turn-Off Switching Time on  $R_G$

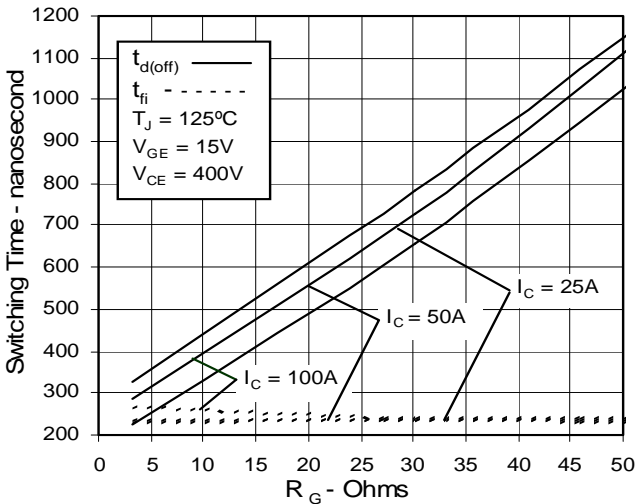
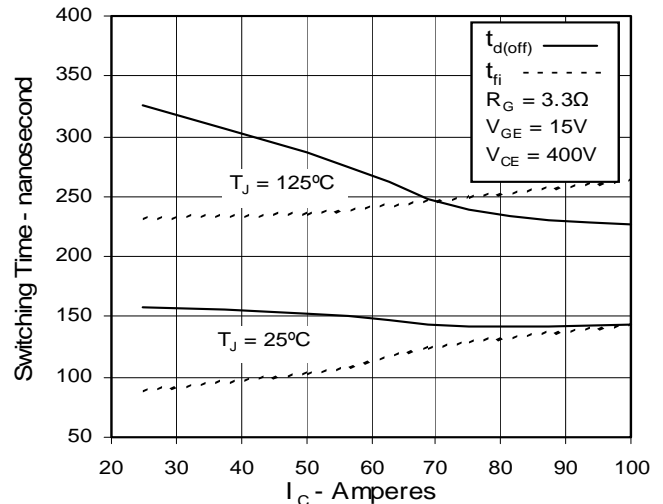
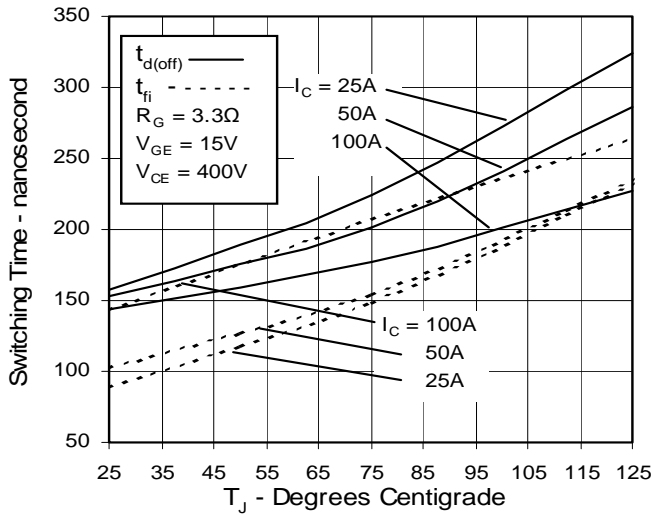

Fig. 12. Dependence of Turn-Off Switching Time on  $I_C$



**Fig. 13. Dependence of Turn-Off Switching Time on Temperature**



**Fig. 14. Gate Charge**

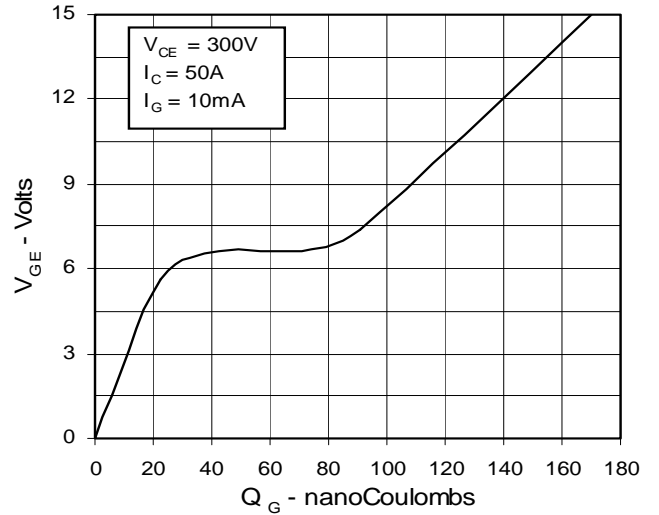

**Fig. 15. Capacitance**

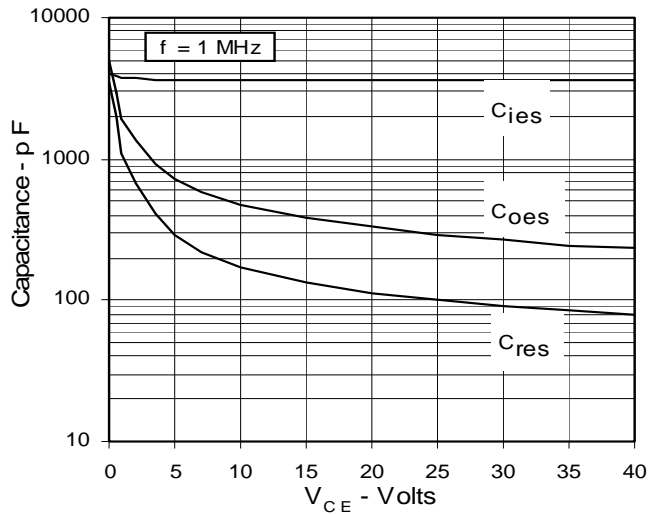

**Fig. 16. Maximum Transient Thermal Resistance**

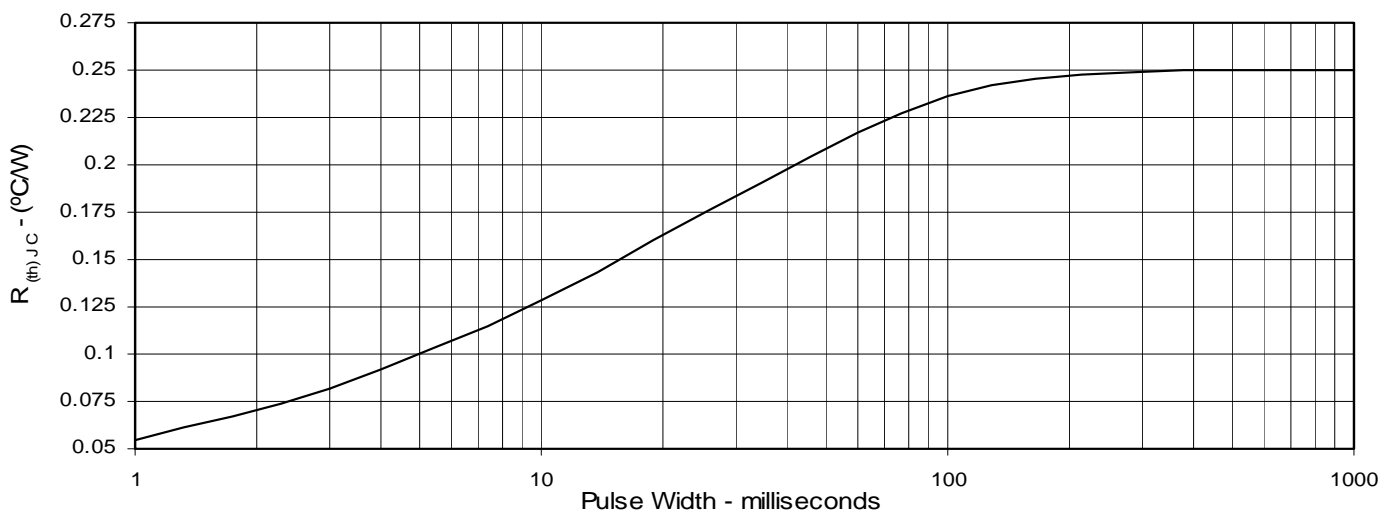

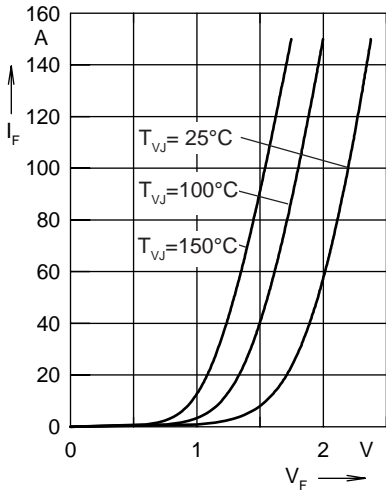

Fig. 17. Forward current  $I_F$  versus  $V_F$

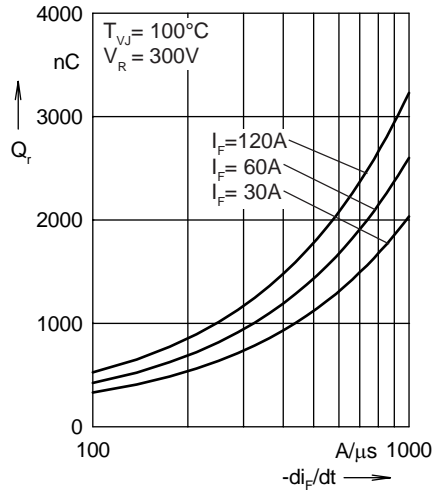

Fig. 18. Reverse recovery charge  $Q_r$  versus  $-di_F/dt$

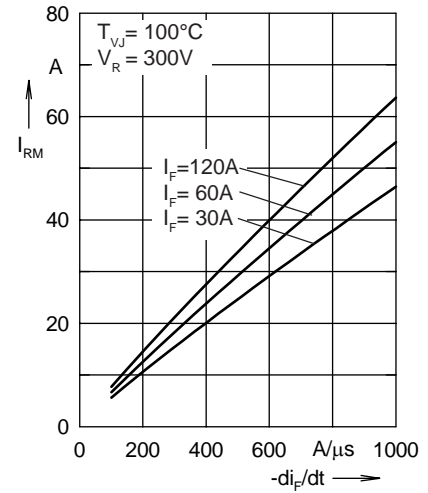

Fig. 19. Peak reverse current  $I_{RM}$  versus  $-di_F/dt$

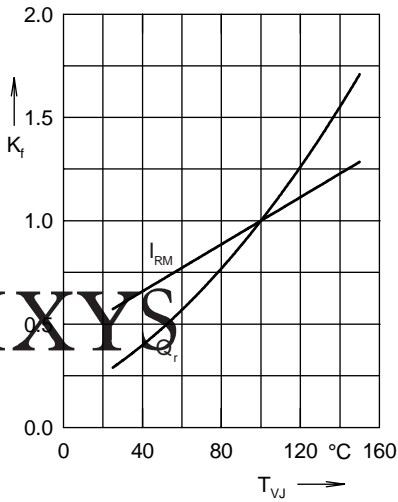

Fig. 20. Dynamic parameters  $Q_r$ ,  $I_{RM}$  versus  $T_{VJ}$

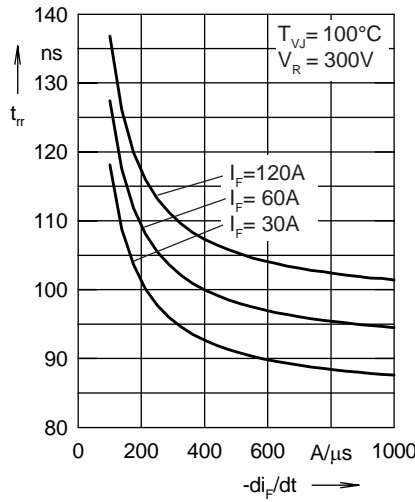

Fig. 21. Recovery time  $t_{tr}$  versus  $-di_F/dt$

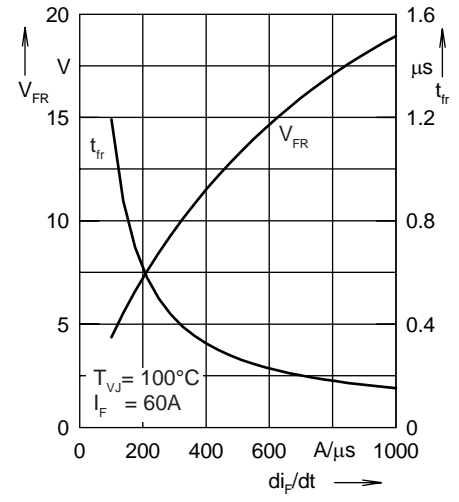

Fig. 22. Peak forward voltage  $V_{FR}$  and  $t_{tr}$  versus  $di_F/dt$

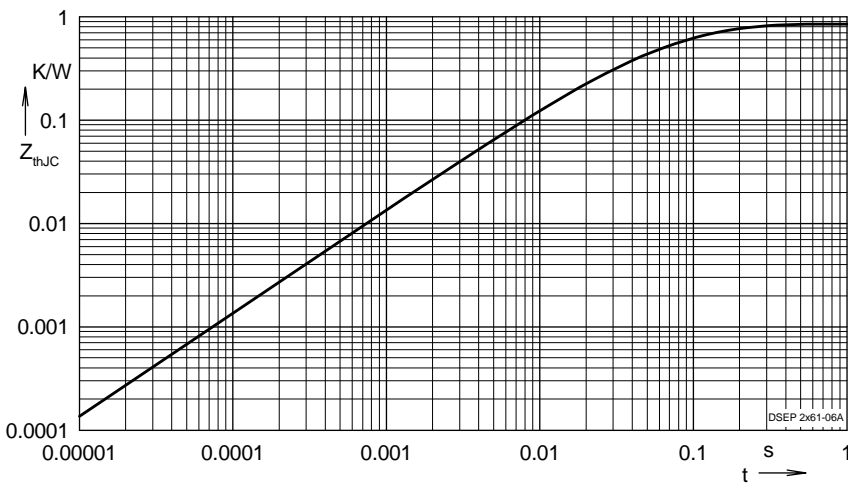

Fig. 23. Transient thermal resistance junction to case

Constants for  $Z_{thJC}$  calculation:

i	$R_{thi}$ (K/W)	$t_i$ (s)
1	0.3073	0.0055
2	0.3533	0.0092
3	0.0887	0.0007
4	0.1008	0.0399