

High Voltage
High speed IGBT

IXSH35N140A

Short Circuit SOA Capability

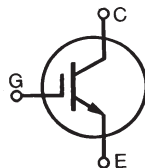

$$V_{CES} = 1400V$$

$$I_{C90} = 35A$$

$$V_{CE(sat)} \leq 4.0V$$

$$t_{fi(typ)} = 200ns$$

TO-247

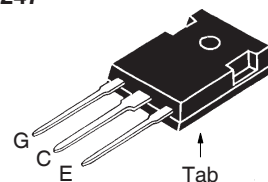

G = Gate C = Collector
E = Emitter Tab = Collector

Symbol	Test Conditions	Maximum Ratings	
V_{CES}	$T_J = 25^\circ C$ to $150^\circ C$	1400	V
V_{CGR}	$T_J = 25^\circ C$ to $150^\circ C$, $R_{GE} = 1M\Omega$	1400	V
V_{GES}	Continuous	± 20	V
V_{GEM}	Transient	± 30	V
I_{C25}	$T_C = 25^\circ C$	70	A
I_{C90}	$T_C = 90^\circ C$	35	A
I_{CM}	$T_C = 25^\circ C$, 1ms	140	A
SSOA (RBSOA)	$V_{GE} = 15V$, $T_J = 125^\circ C$, $R_G = 3\Omega$ Clamped Inductive Load	$I_{CM} = 70$ @ $V_{CE} \leq 960$	A V
t_{SC} (SCSOA)	$V_{GE} = 15V$, $V_{CE} = 840V$, $T_J = 125^\circ C$ $R_G = 22\Omega$, non Repetitive	10	μs
P_C	$T_C = 25^\circ C$	300	W
T_J		-55 ... +150	$^\circ C$
T_{JM}		150	$^\circ C$
T_{stg}		-55 ... +150	$^\circ C$
M_d	Mounting Torque	1.13 / 10	Nm/lb.in.
T_L	Maximum Lead Temperature for Soldering	300	$^\circ C$
T_{SOLD}	1.6mm (0.062 in.) from Case for 10s	260	$^\circ C$
Weight		6	g

Features

- International Standard Package JEDEC TO-247AD
- High Frequency IGBT with Guaranteed Short Circuit SOA Capability
- Fast Fall Time for Switching Speeds up to 20kHz
- 2nd Generation HDMOS™ Process
- Low $V_{CE(SAT)}$ - for Minimum on-state Conduction Losses
- MOS Gate turn-on

Advantages

- High Power Density
- Easy to Mount
- Space Savings

Applications

- DC-DC Converters
- Switch-Mode and Resonant-Mode Power Supplies
- DC Choppers
- AC and DC Motor Drives
- Uninterrupted Power Supplies
- Welding

Symbol	Test Conditions ($T_J = 25^\circ C$, Unless Otherwise Specified)	Characteristic Values		
		Min.	Typ.	Max.
$V_{GE(th)}$	$I_C = 4mA$, $V_{CE} = V_{GE}$	4.5		7.5 V
I_{CES}	$V_{CE} = V_{CES}$, $V_{GE} = 0V$ $T_J = 125^\circ C$			50 μA 2 mA
I_{GES}	$V_{CE} = 0V$, $V_{GE} = \pm 20V$			± 100 nA
$V_{CE(sat)}$	$I_C = 35A$, $V_{GE} = 15V$, Note 1		3.4	4.0 V

Symbol	Test Conditions ($T_J = 25^\circ\text{C}$, Unless Otherwise Specified)	Characteristic Values			
		Min.	Typ.	Max.	
g_{fs}	$I_C = 35\text{A}, V_{CE} = 10\text{V}$, Note 1	16	23	S	
C_{ies}	$V_{CE} = 25\text{V}, V_{GE} = 0\text{V}, f = 1\text{MHz}$		3710	pF	
C_{oes}			230	pF	
C_{res}			73	pF	
Q_g	$I_C = 35\text{A}, V_{GE} = 15\text{V}, V_{CE} = 0.5 \cdot V_{CES}$		120	nC	
Q_{ge}			32	nC	
Q_{gc}			50	nC	
$t_{d(on)}$	Inductive load, $T_J = 25^\circ\text{C}$ $I_C = 35\text{A}, V_{GE} = 15\text{V}$ $V_{CE} = 960\text{V}, R_G = 3\Omega$ Note 2		40	ns	
t_{ri}			60	ns	
$t_{d(off)}$			150	300	ns
t_{fi}			200	450	ns
E_{off}			4.0		mJ
$t_{d(on)}$	Inductive load, $T_J = 125^\circ\text{C}$ $I_C = 35\text{A}, V_{GE} = 15\text{V}$ $V_{CE} = 960\text{V}, R_G = 3\Omega$ Note 2		40	ns	
t_{ri}			65	ns	
E_{on}			4.0		mJ
$t_{d(off)}$			240		ns
E_{off}			9.5		mJ
R_{thJC}				0.42 $^\circ\text{C}/\text{W}$	
R_{thCK}		0.21		$^\circ\text{C}/\text{W}$	

TO-247 (IXSH) Outline

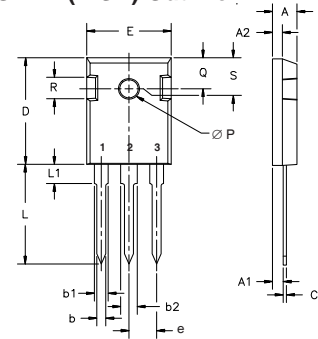

Terminals: 1 - Gate
2 - Collector
3 - Emitter

Dim.	Millimeter		Inches	
	Min.	Max.	Min.	Max.
A	4.7	5.3	.185	.209
A ₁	2.2	2.54	.087	.102
A ₂	2.2	2.6	.059	.098
b	1.0	1.4	.040	.055
b ₁	1.65	2.13	.065	.084
b ₂	2.87	3.12	.113	.123
C	.4	.8	.016	.031
D	20.80	21.46	.819	.845
E	15.75	16.26	.610	.640
e	5.20	5.72	0.205	0.225
L	19.81	20.32	.780	.800
L1		4.50		.177
∅P	3.55	3.65	.140	.144
Q	5.89	6.40	0.232	0.252
R	4.32	5.49	.170	.216
S	6.15	BSC	242	BSC

Notes:

1. Pulse test, $t \leq 300\mu\text{s}$, duty cycle, $d \leq 2\%$.
2. Switching times & energy losses may increase for higher V_{CE} (Clamp), T_J or R_G .

IXYS Reserves the Right to Change Limits, Test Conditions, and Dimensions.

IXYS MOSFETs and IGBTs are covered by one or more of the following U.S. patents:	4,835,592	4,931,844	5,049,961	5,237,481	6,162,665	6,404,065 B1	6,683,344	6,727,585	7,005,734 B2	7,157,338B2
	4,850,072	5,017,508	5,063,307	5,381,025	6,259,123 B1	6,534,343	6,710,405 B2	6,759,692	7,063,975 B2	
	4,881,106	5,034,796	5,187,117	5,486,715	6,306,728 B1	6,583,505	6,710,463	6,771,478 B2	7,071,537	

**Fig. 1. Output Characteristics
@ 25°C**

**Fig. 2. Extended Output Characteristics
@ 25°C**

**Fig. 3. Output Characteristics
@ 125°C**

Fig. 4. Temperature Dependence of $V_{CE(sat)}$

**Fig. 5. Collector-to-Emitter Voltage
vs. Gate-to-Emitter voltage**

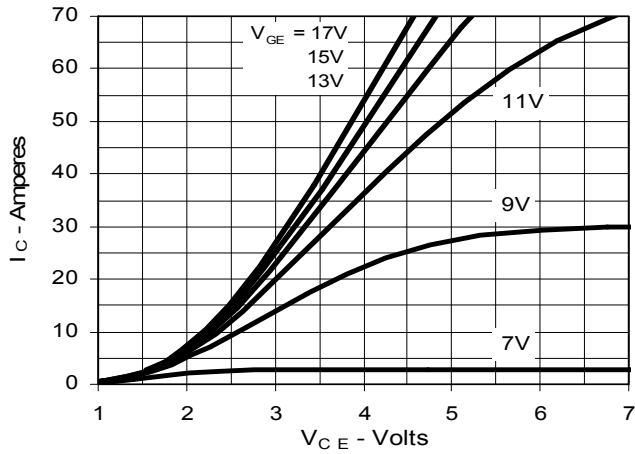
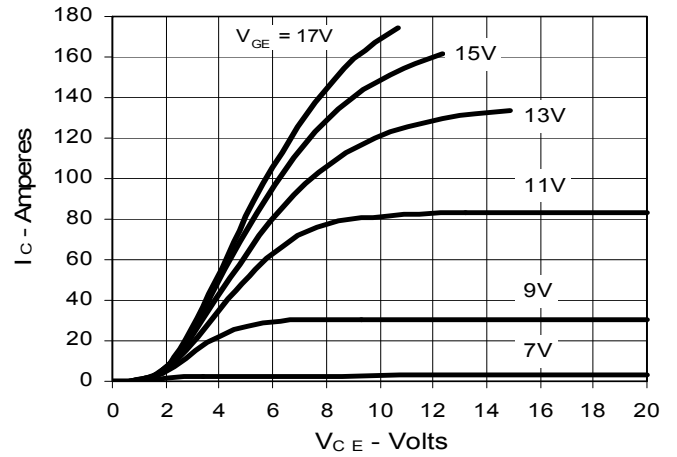
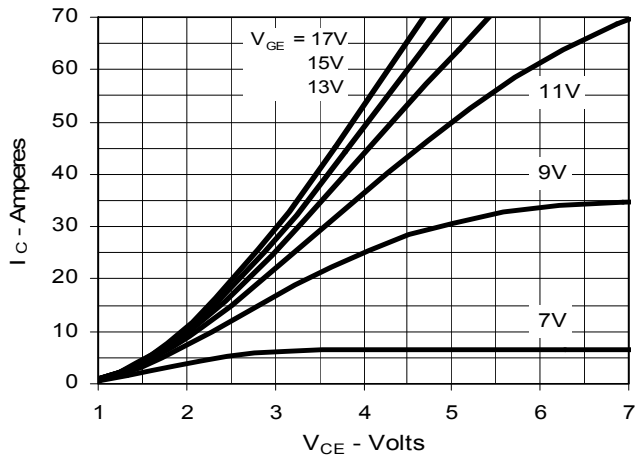
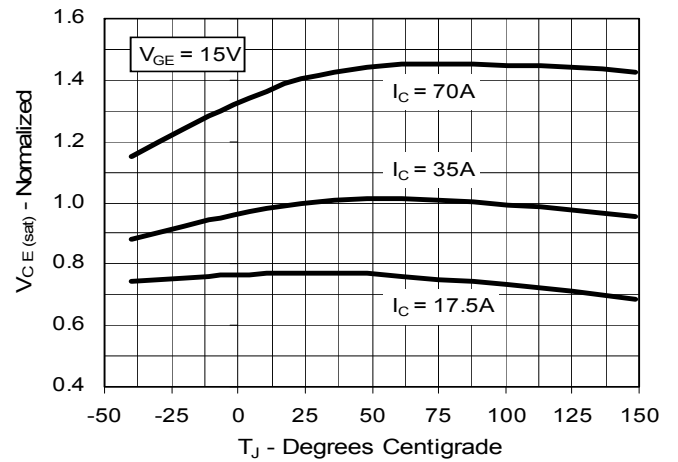
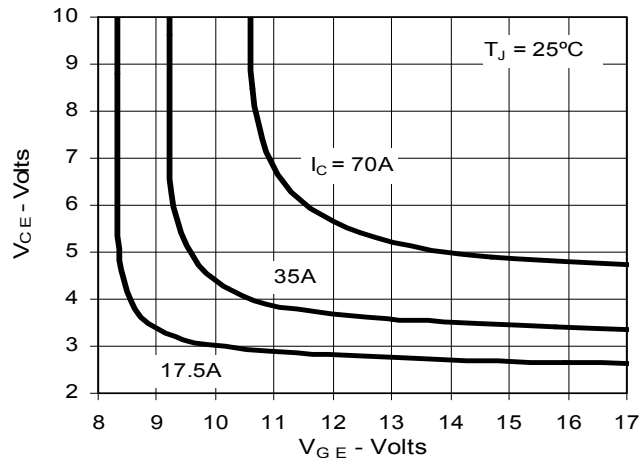
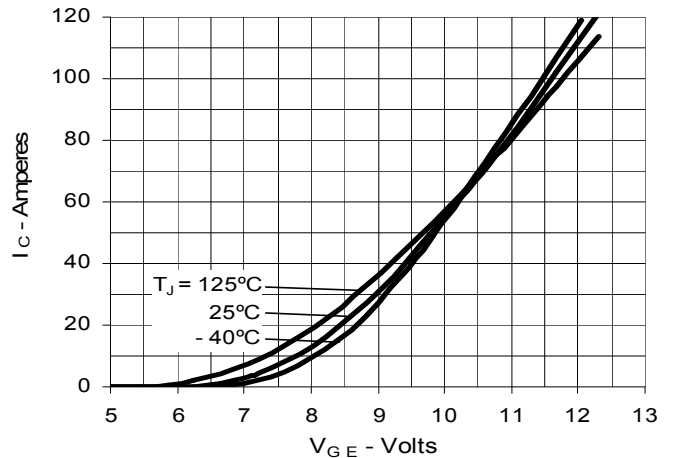
Fig. 6. Input Admittance

Fig. 7. Transconductance

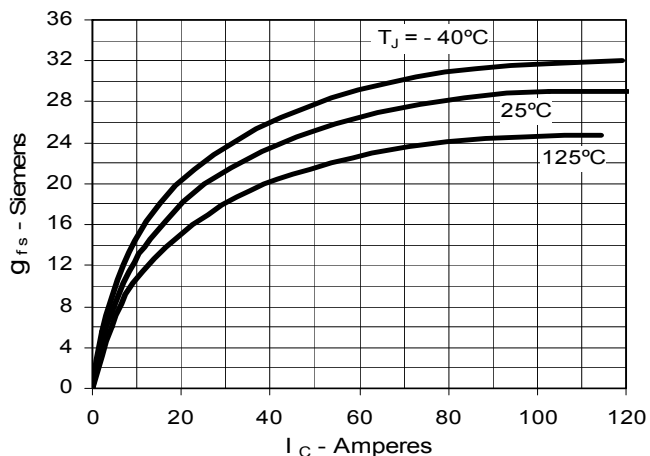

Fig. 8. Dependence of E_{off} on R_G

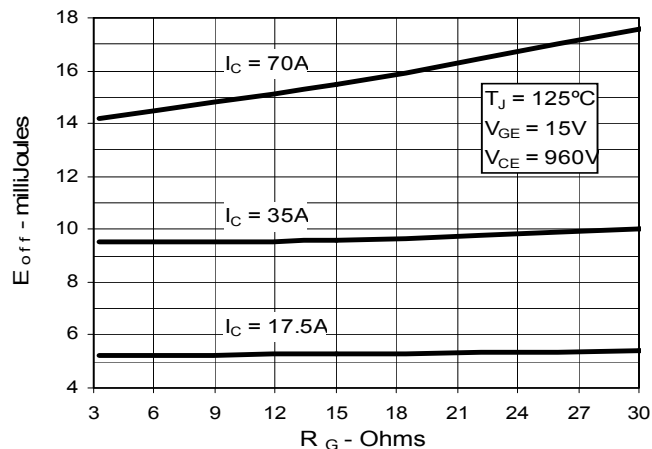

Fig. 9. Dependence of E_{off} on I_C

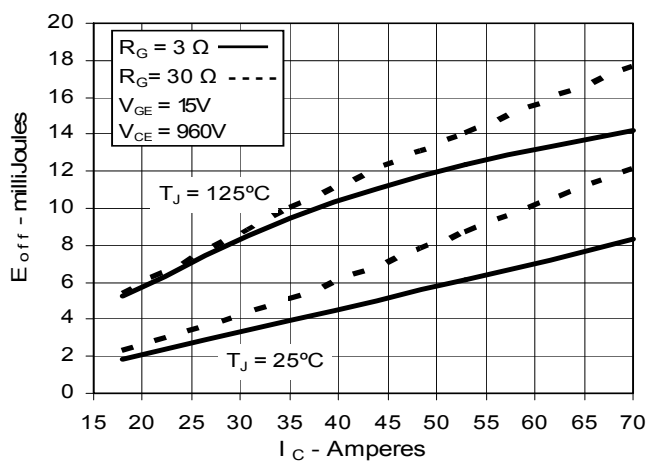

Fig. 10. Dependence of E_{off} on Temperature

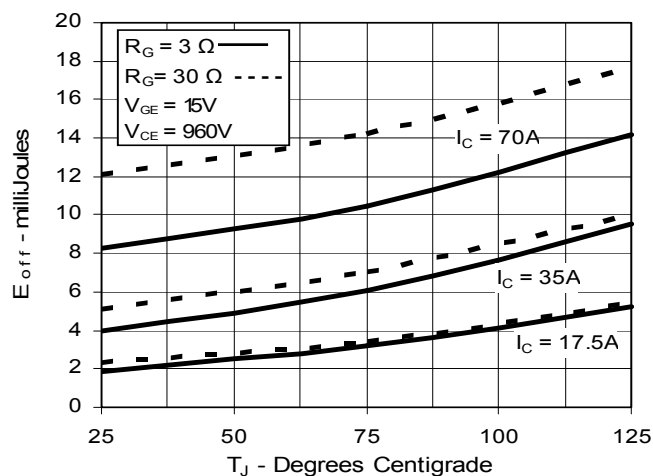

Fig. 11. Gate Charge

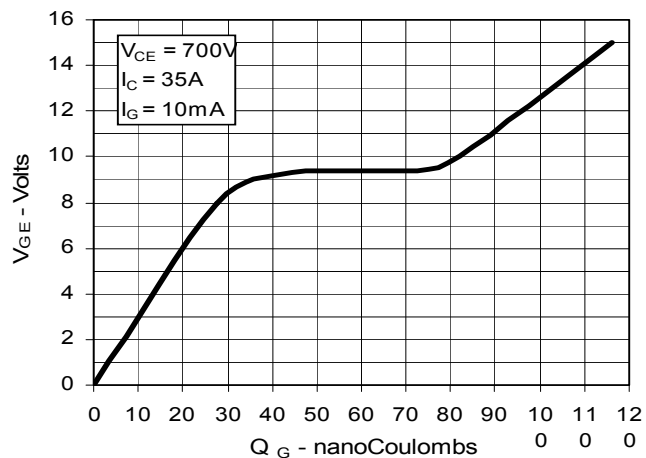

Fig. 12. Capacitance

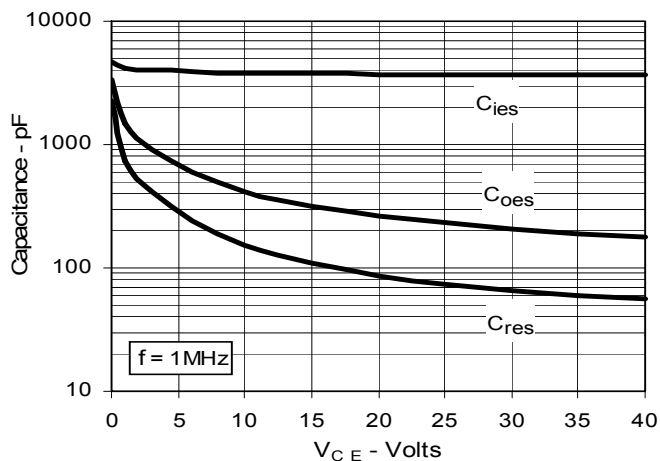

Fig. 13. Maximum Transient Thermal Impedance

