

# HiPerFET™ Power MOSFETs Q-Class

**IXFH 32N50Q**  
**IXFT 32N50Q**

N-Channel Enhancement Mode  
Avalanche Rated, Low  $Q_g$ , High  $dv/dt$

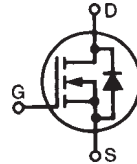

$V_{DSS}$	$I_{D25}$	$R_{DS(on)}$
500 V	32 A	0.16 $\Omega$
500 V	32 A	0.16 $\Omega$

$t_{rr} \leq 250$  ns

Symbol	Test Conditions	Maximum Ratings	
$V_{DSS}$	$T_J = 25^\circ\text{C}$ to $150^\circ\text{C}$	500	V
$V_{DGR}$	$T_J = 25^\circ\text{C}$ to $150^\circ\text{C}$ ; $R_{GS} = 1$ M $\Omega$	500	V
$V_{GS}$	Continuous	$\pm 20$	V
$V_{GSM}$	Transient	$\pm 30$	V
$I_{D25}$	$T_C = 25^\circ\text{C}$	32	A
$I_{DM}$	$T_C = 25^\circ\text{C}$ ; pulse width limited by $T_{JM}$	128	A
$I_{AR}$	$T_C = 25^\circ\text{C}$	32	A
$E_{AR}$	$T_C = 25^\circ\text{C}$	45	mJ
$E_{AS}$		1500	mJ
$dv/dt$	$I_S \leq I_{DM}$ , $di/dt \leq 100$ A/ $\mu\text{s}$ , $V_{DD} \leq V_{DSS}$ , $T_J \leq 150^\circ\text{C}$ , $R_G = 2$ $\Omega$	5	V/ns
$P_D$	$T_C = 25^\circ\text{C}$	416	W
$T_J$		-55 ... + 150	$^\circ\text{C}$
$T_{JM}$		150	$^\circ\text{C}$
$T_{stg}$		-55 ... + 150	$^\circ\text{C}$
$T_L$	1.6 mm (0.063 in) from case for 10 s	300	$^\circ\text{C}$
$M_d$	Mounting torque	1.13/10	Nm/lb.in.
Weight	TO-247	6	g
	TO-268	4	g

TO-247 AD (IXFH)

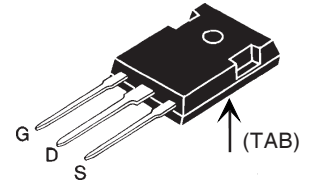

TO-268 (D3) (IXFT)

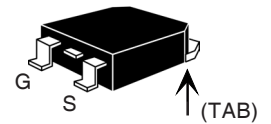

G = Gate      D = Drain  
S = Source      TAB = Drain

Symbol	Test Conditions	Characteristic Values ( $T_J = 25^\circ\text{C}$ , unless otherwise specified)		
		min.	typ.	max.
$V_{DSS}$	$V_{GS} = 0$ V, $I_D = 250$ $\mu\text{A}$	500		V
$V_{GS(th)}$	$V_{DS} = V_{GS}$ , $I_D = 4$ mA	2.5		V
$I_{GSS}$	$V_{GS} = \pm 20$ V <sub>DC</sub> , $V_{DS} = 0$			$\pm 100$ nA
$I_{DSS}$	$V_{DS} = V_{DSS}$ , $V_{GS} = 0$ V			100 $\mu\text{A}$ 1 mA
$R_{DS(on)}$	$V_{GS} = 10$ V, $I_D = 0.5$ $I_{D25}$ Note 1			0.16 $\Omega$

## Features

- IXYS advanced low  $Q_g$  process
- Low gate charge and capacitances
  - easier to drive
  - faster switching
- International standard packages
- Low  $R_{DS(on)}$
- Unclamped Inductive Switching (UIS) rated
- Molding epoxies meet UL 94 V-0 flammability classification

## Advantages

- Easy to mount
- Space savings
- High power density

Symbol	Test Conditions	Characteristic Values			
		$(T_J = 25^\circ\text{C}, \text{ unless otherwise specified})$			
		min.	typ.	max.	
$g_{fs}$	$V_{DS} = 10\text{ V}; I_D = 0.5 \cdot I_{D25}$ , Note 1	18	28		S
$C_{iss}$	$V_{GS} = 0\text{ V}, V_{DS} = 25\text{ V}, f = 1\text{ MHz}$		3950	4925	pF
$C_{oss}$			640	800	pF
$C_{rss}$			210	260	pF
$t_{d(on)}$	$V_{GS} = 10\text{ V}, V_{DS} = 0.5 \cdot V_{DSS}, I_D = 0.5 \cdot I_{D25}$ $R_G = 2\ \Omega$ (External),		35	45	ns
$t_r$			42	50	ns
$t_{d(off)}$			75	95	ns
$t_f$			20	25	ns
$Q_{g(on)}$	$V_{GS} = 10\text{ V}, V_{DS} = 0.5 \cdot V_{DSS}, I_D = 0.5 \cdot I_{D25}$		153	190	nC
$Q_{gs}$			26	32	nC
$Q_{gd}$			85	105	nC
$R_{thJC}$	(TO-247)			0.30	K/W
$R_{thCK}$			0.25		K/W

Symbol	Test Conditions	Characteristic Values			
		$(T_J = 25^\circ\text{C}, \text{ unless otherwise specified})$			
		min.	typ.	max.	
$I_s$	$V_{GS} = 0\text{ V}$			32	A
$I_{SM}$	Repetitive; pulse width limited by $T_{JM}$			128	A
$V_{SD}$	$I_F = I_s, V_{GS} = 0\text{ V}$ , Note 1			1.5	V
$t_{rr}$	$I_F = I_s, -di/dt = 100\text{ A}/\mu\text{s}, V_R = 100\text{ V}$		0.75	250	ns
$Q_{RM}$			7.5		$\mu\text{C}$
$I_{RM}$					A

Note 1: Pulse test,  $t \leq 300\ \mu\text{s}$ , duty cycle  $d \leq 2\%$

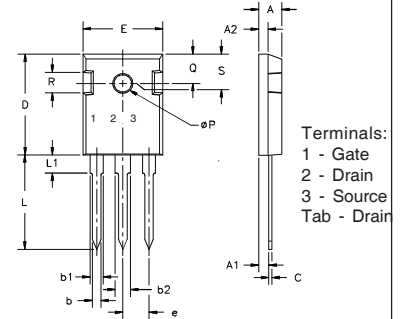
**TO-247 AD (IXFH) Outline**

Dim.	Millimeter		Inches	
	Min.	Max.	Min.	Max.
A	4.7	5.3	.185	.209
A <sub>1</sub>	2.2	2.54	.087	.102
A <sub>2</sub>	2.2	2.6	.059	.098
b	1.0	1.4	.040	.055
b <sub>1</sub>	1.65	2.13	.065	.084
b <sub>2</sub>	2.87	3.12	.113	.123
C	.4	.8	.016	.031
D	20.80	21.46	.819	.845
E	15.75	16.26	.610	.640
e	5.20	5.72	0.205	0.225
L	19.81	20.32	.780	.800
L <sub>1</sub>		4.50		.177
∅P	3.55	3.65	.140	.144
Q	5.89	6.40	0.232	0.252
R	4.32	5.49	.170	.216
S	6.15	BSC	.242	BSC

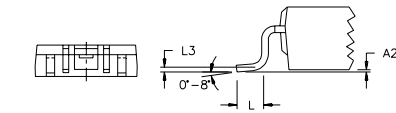
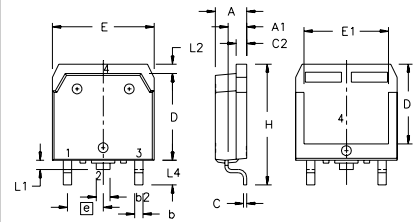
**TO-268 Outline**

Terminals: 1 - Gate    2 - Drain  
3 - Source    Tab - Drain

SYM	INCHES		MILLIMETERS	
	MIN	MAX	MIN	MAX
A	.193	.201	4.90	5.10
A <sub>1</sub>	.106	.114	2.70	2.90
A <sub>2</sub>	.001	.010	0.02	0.25
b	.045	.057	1.15	1.45
b <sub>2</sub>	.075	.083	1.90	2.10
C	.016	.026	0.40	0.65
C <sub>2</sub>	.057	.063	1.45	1.60
D	.543	.551	13.80	14.00
D <sub>1</sub>	.488	.500	12.40	12.70
E	.624	.632	15.85	16.05
E <sub>1</sub>	.524	.535	13.30	13.60
e		.215 BSC		5.45 BSC
H	.736	.752	18.70	19.10
L	.094	.106	2.40	2.70
L <sub>1</sub>	.047	.055	1.20	1.40
L <sub>2</sub>	.039	.045	1.00	1.15
L <sub>3</sub>		.010 BSC		0.25 BSC
L <sub>4</sub>	.150	.161	3.80	4.10

IXYS reserves the right to change limits, test conditions, and dimensions.

Figure 1. Output Characteristics at 25°C

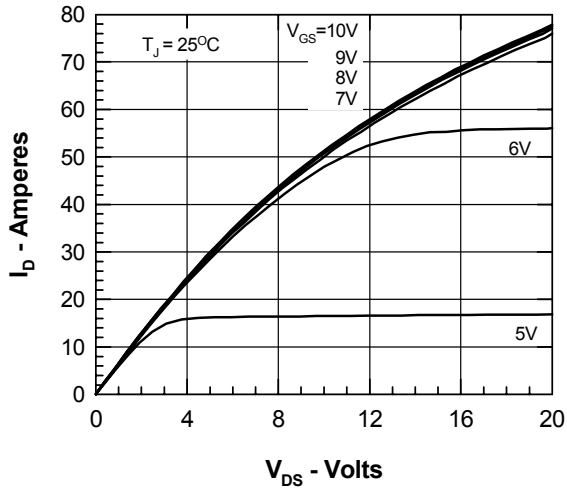

Figure 2. Output Characteristics at 125°C

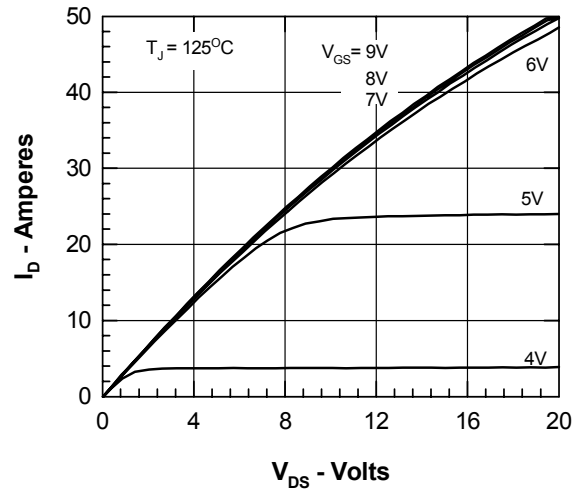

Figure 3.  $R_{DS(on)}$  normalized to 15A/25°C vs.  $I_D$

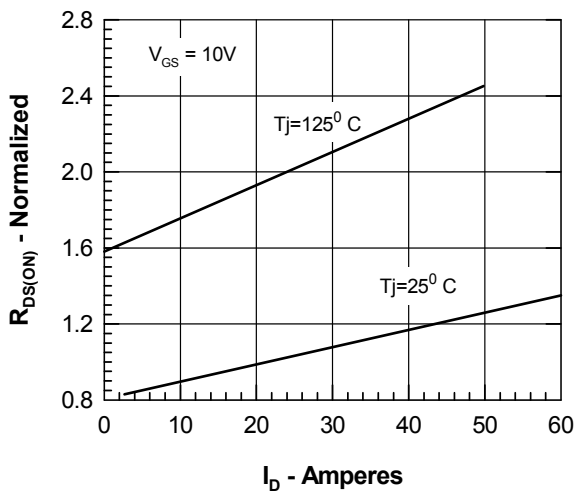

Figure 4.  $R_{DS(on)}$  normalized to 15A/25°C vs.  $T_J$

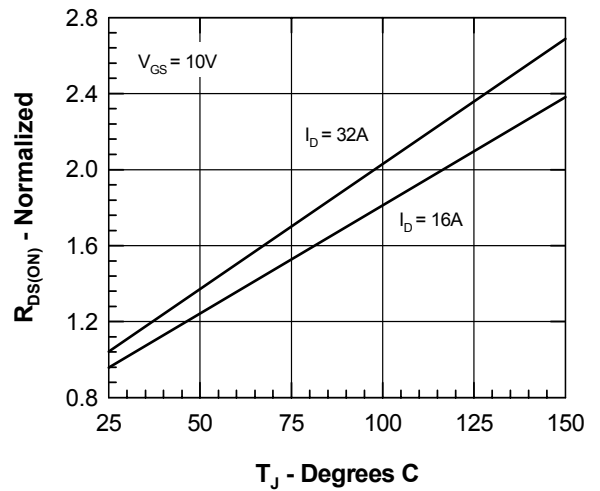

Figure 5. Drain Current vs. Case Temperature

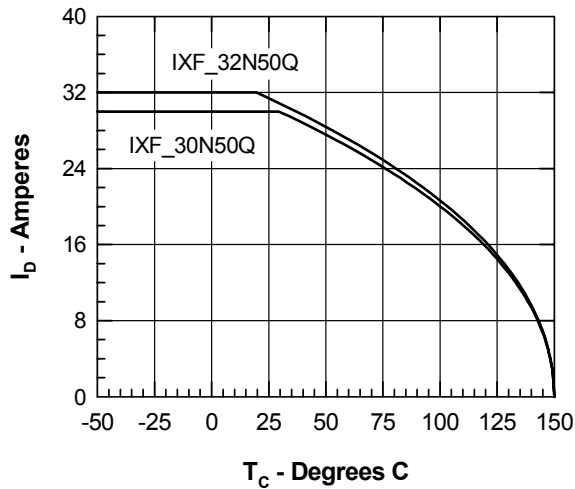

Figure 6. Admittance Curves

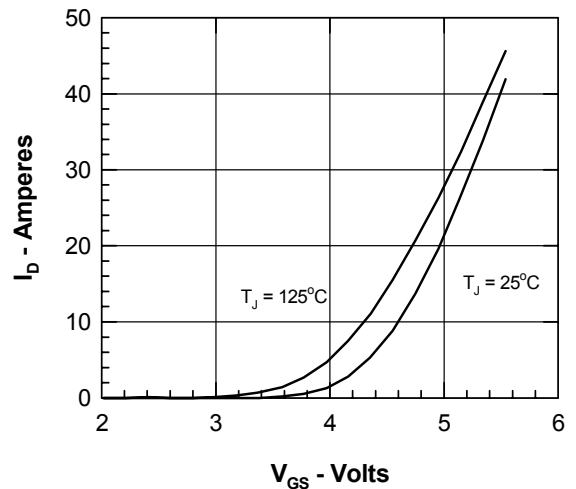

Figure 7. Gate Charge

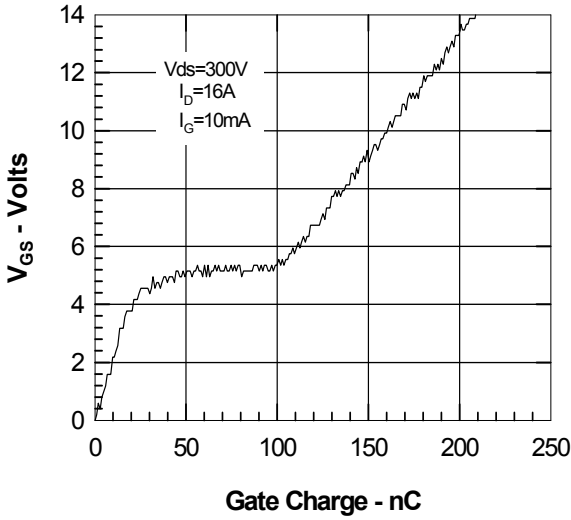

Figure 8. Capacitance Curves

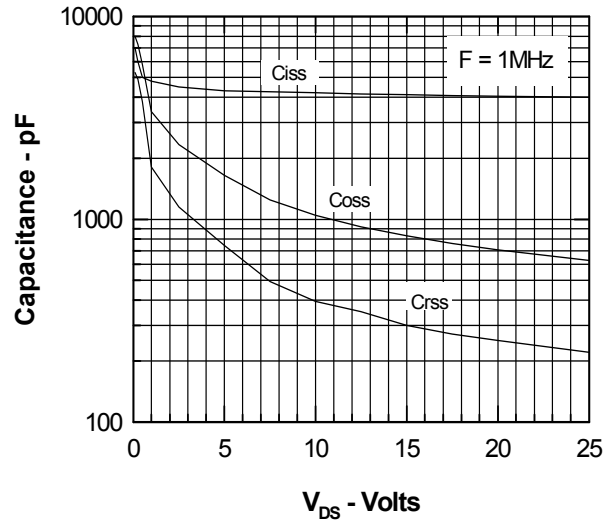

Figure 9. Forward Voltage Drop of the Intrinsic Diode

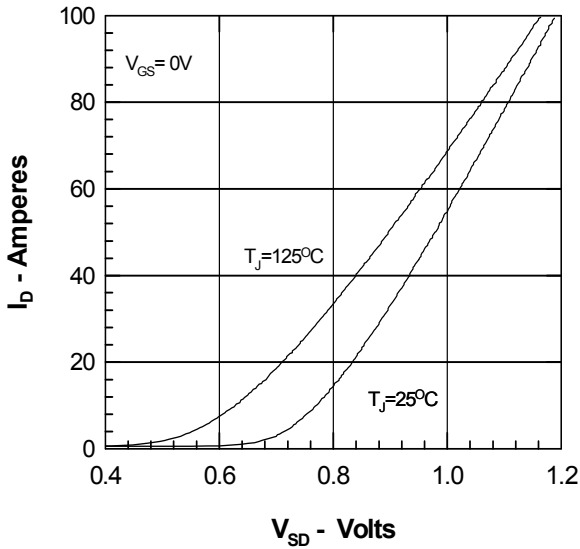

Figure 10. Transient Thermal Resistance

