

High Power Single Thyristor Modules

$I_{FRMS} = 750 \text{ A}$
 $I_{FAVM} = 464 \text{ A}$
 $V_{RRM} = 2000\text{-}2200 \text{ V}$

V_{RSM} V	V_{RRM} V	Type
2100	2000	MCO 450-20io1
2300	2200	MCO 450-22io1

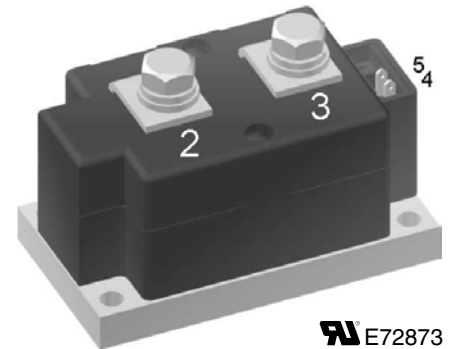
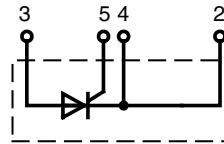

E72873

Symbol	Conditions	Maximum Ratings
I_{TRMS}	$T_{VJ} = T_{VJM}$	$T_C = 25^\circ\text{C}$ 750 A
I_{TAV}	180° sine	$T_C = 85^\circ\text{C}$ 464 A
I_{TSM}	$T_{VJ} = 45^\circ\text{C}; V_R = 0$	t = 10 ms (50 Hz) 15000 A
		t = 8.3 ms (60 Hz) 16000 A
I^2t	$T_{VJ} = 45^\circ\text{C}; V_R = 0$	t = 10 ms (50 Hz) 1 125 000 A ² s
		t = 8.3 ms (60 Hz) 1 062 000 A ² s
$(di/dt)_{cr}$	$T_{VJ} = T_{VJM}; f = 50 \text{ Hz}; t_p = 200 \mu\text{s}; V_D = \frac{2}{3} V_{DRM}; I_G = 1 \text{ A}; di_G/dt = 1 \text{ A}/\mu\text{s}$	repetitive, $I_T = 960 \text{ A}$ 100 A/ μs
		non repetitive, $I_T = I_{TAVM}$ 500 A/ μs
$(dv/dt)_{cr}$	$T_{VJ} = T_{VJM}; V_D = \frac{2}{3} V_{DRM}; R_{GK} = \infty$; method 1 (linear voltage rise)	1000 V/ μs
P_{GM}	$T_{VJ} = T_{VJM}; t_p = 30 \mu\text{s}$	120 W
	$I_T = I_{T(AV)M}; t_p = 500 \mu\text{s}$	60 W
P_{GAV}		30 W
V_{RGM}		10 V
T_{VJ}		-40...+130 °C
T_{VJM}		130 °C
T_{stg}		-40...+125 °C
V_{ISOL}	50/60 Hz, RMS t = 1 min	3000 V~
	$I_{ISOL} \leq 1 \text{ mA}$ t = 1 s	3600 V~
M_d	Mounting torque (M6)	4.5 - 7 Nm
	Terminal connection torque (M8)	11-13 Nm
Weight	Typical including screws	650 g

Features

- Direct Copper Bonded Al_2O_3 ceramic with copper base plate
- Planar passivated chips
- Isolation voltage 3600 V~
- UL registered
- Keyed gate/cathode twin pins

Applications

- Motor control, soft starter
- Power converter
- Heat and temperature control for industrial furnaces and chemical processes
- Lighting control
- L

Advantages

- Improved temperature & power cycling
- Reduced protection circuits

Data according to IEC 60747 and refer to a single diode unless otherwise stated.

Symbol	Conditions	Characteristic Values	
		typ.	max.
I_{RRM}	$V_R = V_{RRM}$	$T_{VJ} = T_{VJM}$	40 mA
V_T	$I_T = 600$ A	$T_{VJ} = 25^\circ\text{C}$	1.15 V
V_{T0}	For power-loss calculations only		0.77 V
r_t		$T_{VJ} = T_{VJM}$	0.42 mΩ
V_{GT}	$V_D = 6$ V	$T_{VJ} = 25^\circ\text{C}$	2 V
		$T_{VJ} = -40^\circ\text{C}$	3 V
I_{GT}	$V_D = 6$ V	$T_{VJ} = 25^\circ\text{C}$	300 mA
		$T_{VJ} = -40^\circ\text{C}$	400 mA
V_{GD}	$V_D = \frac{2}{3} V_{DRM}$	$T_{VJ} = T_{VJM}$	0.25 V
I_{GD}			10 mA
I_L	$t_p = 30 \mu\text{s}; V_D = 6$ V $I_G = 1$ A; $di_G/dt = 1$ A/ μs	$T_{VJ} = 25^\circ\text{C}$	400 mA
I_H	$V_D = 6$ V; $R_{GK} = \infty$;	$T_{VJ} = 25^\circ\text{C}$	300 mA
t_{gd}	$V_D = \frac{1}{2} V_{DRM}$ $I_G = 1$ A; $di_G/dt = 1$ A/ μs	$T_{VJ} = 25^\circ\text{C}$	2 μs
t_q	$V_D = \frac{2}{3} V_{DRM}$ $dv/dt = 50$ V/ μs ; $-di/dt = 10$ A/ μs $I_T = 500$ A; $V_R = 100$ V; $t_p = 200 \mu\text{s}$	$T_{VJ} = T_{VJM}$	350 μs
R_{thJC}	DC current		0.072 K/W
R_{thJK}	DC current		0.096 K/W
d_S	Creeping distance on surface		12.7 mm
d_A	Creepage distance in air		9.6 mm
a	Maximum allowable acceleration		50 m/s ²

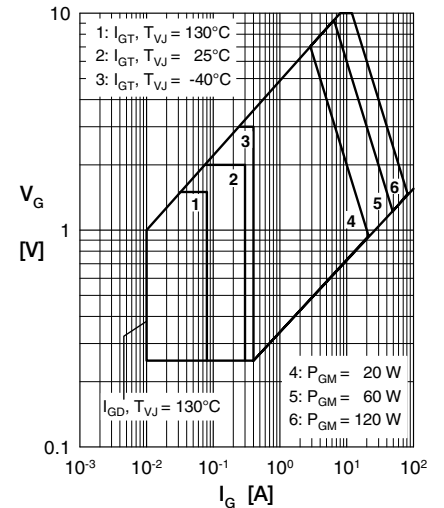

Fig. 1 Gate trigger characteristics

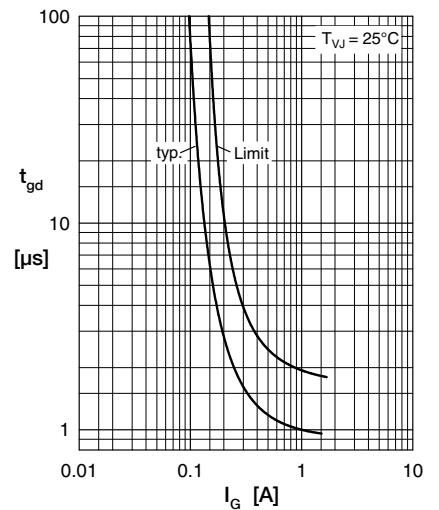
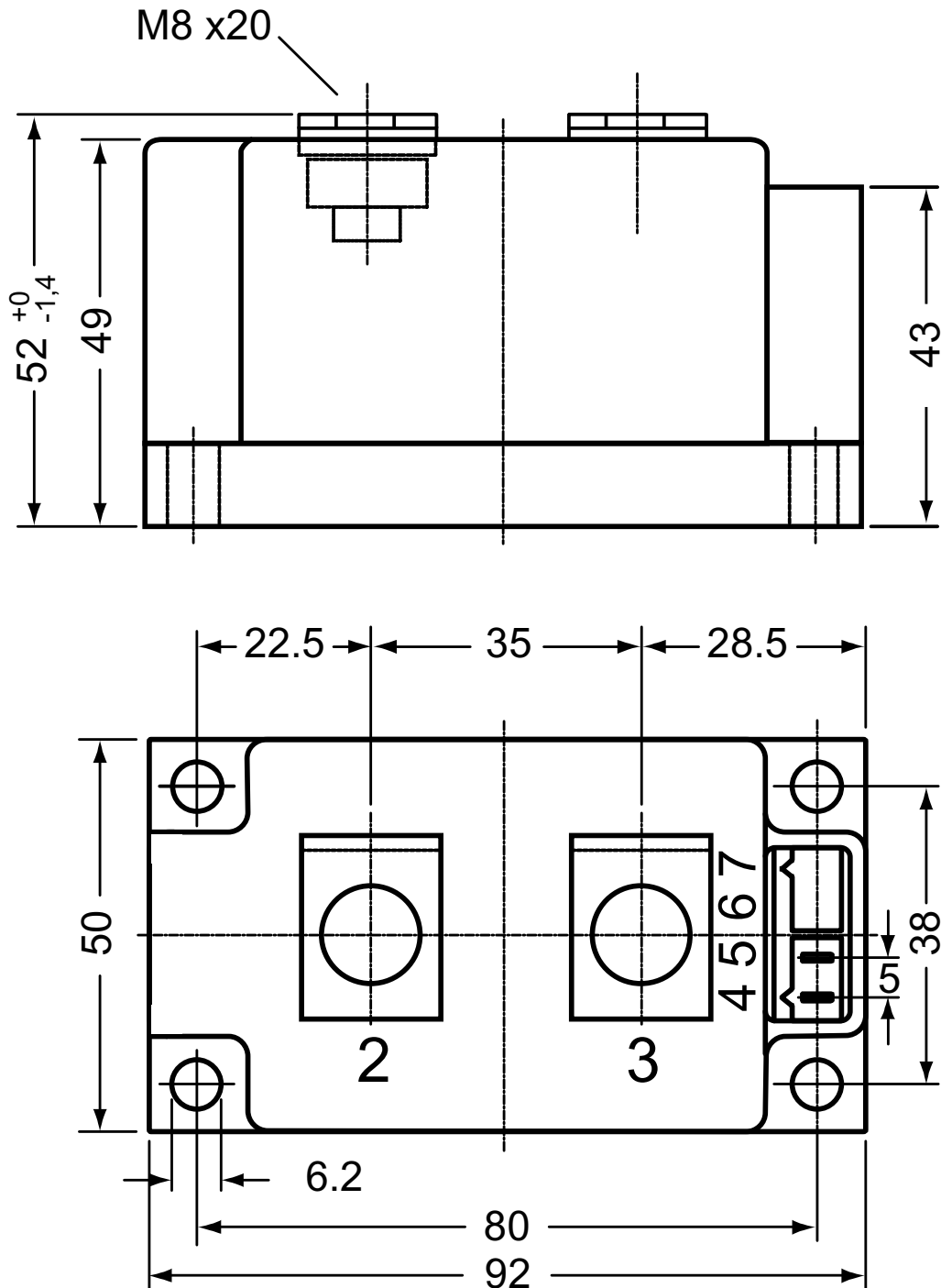

Fig. 2 Gate trigger delay time

Dimensions in mm (1 mm = 0.0394")



Optional accessories for modules

Keyed gate/cathode twin plugs with wire length = 350 mm, gate = white, cathode = red

Type ZY 180L (L = Left for pin pair 4/5)

Type ZY 180R (R = Right for pin pair 6/7) } UL 758, style 3751

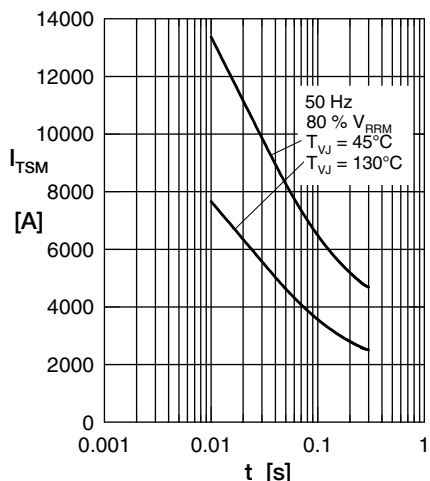

Fig. 3 Surge overload current
 I_{TSM} : Crest value, t : duration

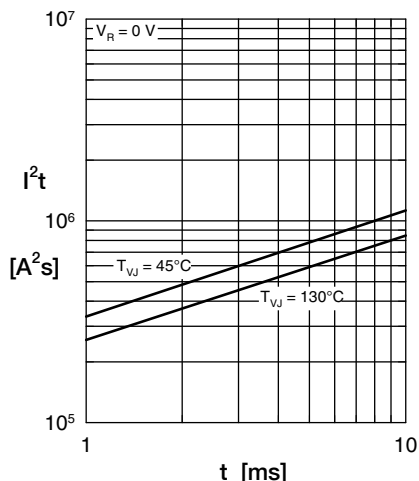

Fig. 4 I^2t versus time (1-10 ms)

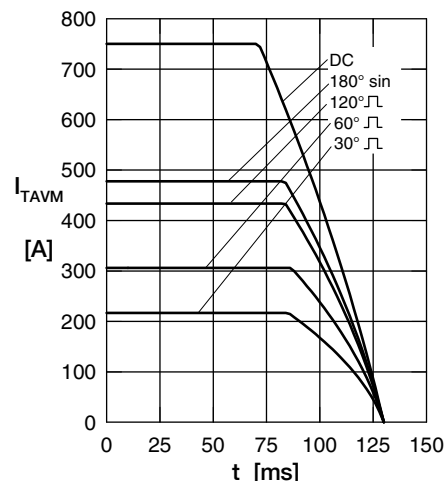

Fig. 5 Maximum forward current at case temperature

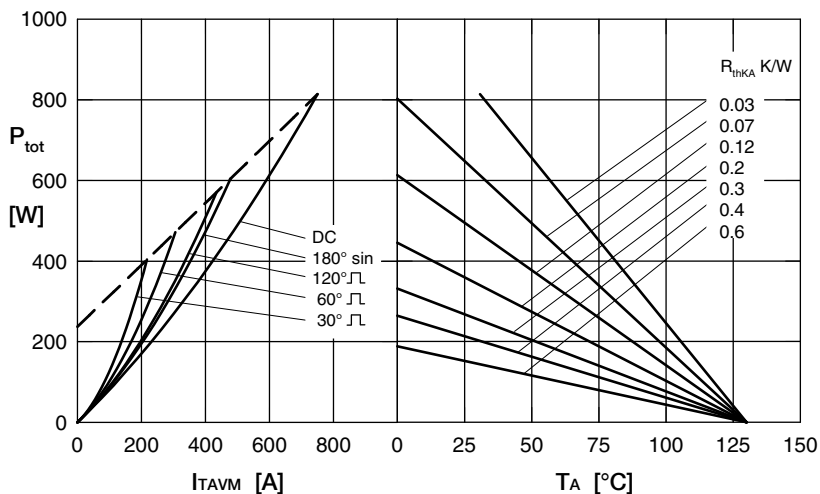

Fig. 6 Power dissipation versus on-state current & ambient temperature

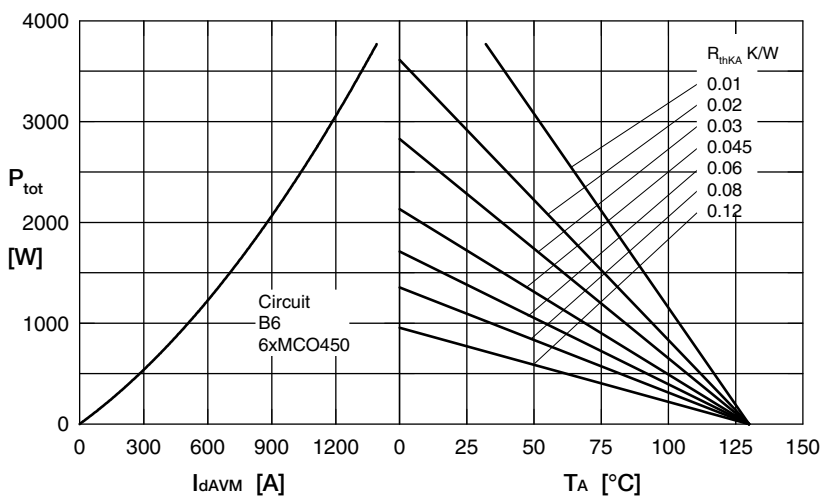

Fig. 7 Three phase rectifier bridge: Power dissipation vs. direct output current and ambient temperature

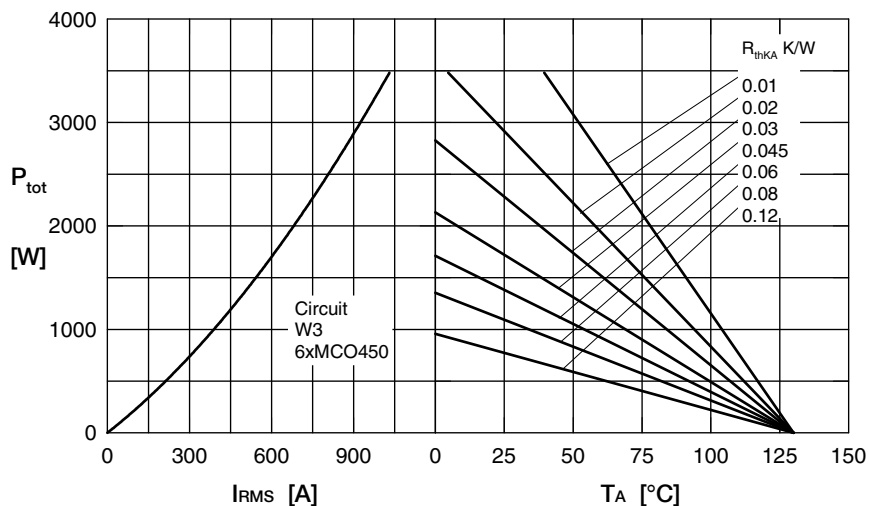

Fig. 8 Three phase AC-controller: Power dissipation versus RMS output current and ambient temperature

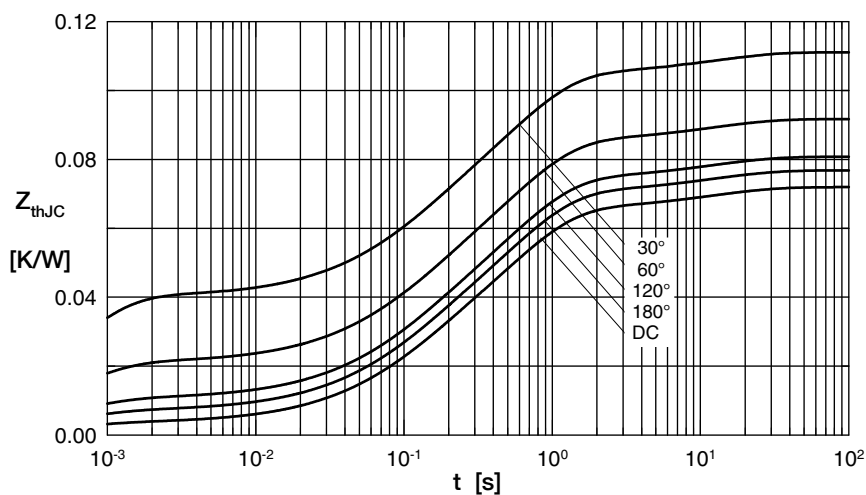

Fig. 9 Transient thermal impedance junction to case

R_{thJC} for various conduction angles d:

d	R_{thJC} (K/W)
DC	0.072
180°	0.0768
120°	0.081
60°	0.092
30°	0.111

Constants for Z_{thJC} calculation:

i	R_{thi} (K/W)	t_i (s)
1	0.0035	0.00054
2	0.0186	0.098
3	0.0432	0.54
4	0.0067	12

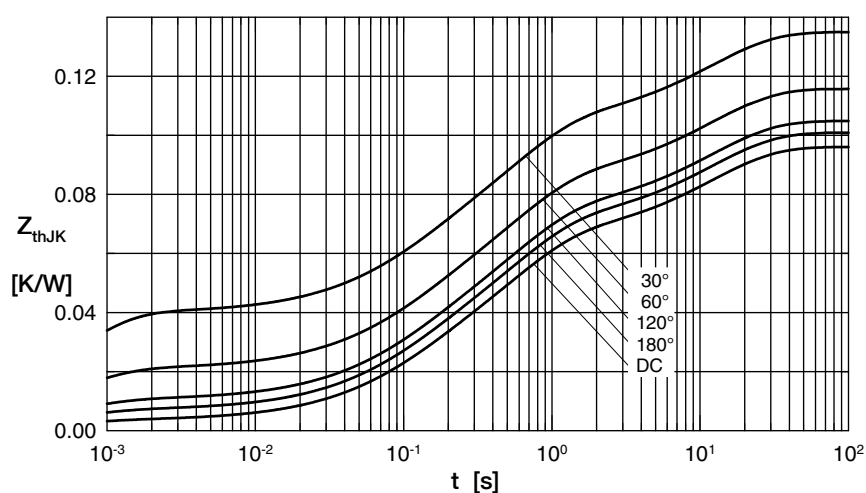

Fig.10 Transient thermal impedance junction to heatsink

R_{thJK} for various conduction angles d:

d	R_{thJK} (K/W)
DC	0.096
180°	0.1
120°	0.105
60°	0.116
30°	0.135

Constants for Z_{thJK} calculation:

i	R_{thi} (K/W)	t_i (s)
1	0.0035	0.0054
2	0.0186	0.098
3	0.0432	0.54
4	0.0067	12
5	0.024	12