

## IGBT

High speed 5 FAST IGBT in TRENCHSTOP™ 5 technology copacked with RAPID 1 fast and soft anti parallel diode

## IKP40N65F5, IKW40N65F5

650V DuoPack IGBT and Diode  
High speed switching series fifth generation

Data sheet

High speed 5 FAST IGBT in TRENCHSTOP™ 5 technology copacked with RAPID 1 fast and soft anti parallel diode

### Features and Benefits:

High speed F5 technology offering

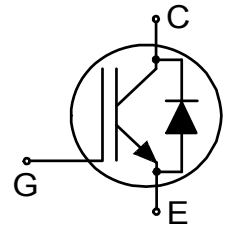
- Best-in-Class efficiency in hard switching and resonant topologies
- 650V breakdown voltage
- Low  $Q_g$
- IGBT copacked with RAPID 1 fast and soft antiparallel diode
- Maximum junction temperature 175°C
- Qualified according to JEDEC for target applications
- Pb-free lead plating; RoHS compliant
- Complete product spectrum and PSpice Models:  
<http://www.infineon.com/igbt/>

### Applications:

- Solar converters
- Uninterruptible power supplies
- Welding converters
- Mid to high range switching frequency converters

### Package pin definition:

- Pin 1 - gate
- Pin 2 & backside - collector
- Pin 3 - emitter



### Key Performance and Package Parameters

Type	$V_{CE}$	$I_C$	$V_{CEsat}, T_{vj}=25^\circ C$	$T_{vjmax}$	Marking	Package
IKW40N65F5	650V	40A	1.6V	175°C	K40F655	PG-TO247-3
IKP40N65F5	650V	40A	1.6V	175°C	K40F655	PG-TO220-3



**Table of Contents**

Description ..... 2

Table of Contents ..... 3

Maximum ratings ..... 4

Thermal Resistance ..... 4

Electrical Characteristics ..... 5

Electrical Characteristics diagrams ..... 8

Package Drawing PG-TO247-3 .....15

Package Drawing PG-TO220-3 .....16

Testing Conditions .....17

Revision History .....18

Disclaimer .....18

**Maximum ratings**

Parameter	Symbol	Value	Unit
Collector-emitter voltage	$V_{CE}$	650	V
DC collector current, limited by $T_{vjmax}$ $T_C = 25^\circ\text{C}$ $T_C = 100^\circ\text{C}$	$I_C$	74.0 46.0	A
Pulsed collector current, $t_p$ limited by $T_{vjmax}$	$I_{Cpuls}$	120.0	A
Turn off safe operating area $V_{CE} \leq 650\text{V}$ , $T_{vj} \leq 175^\circ\text{C}$	-	120.0	A
Diode forward current, limited by $T_{vjmax}$ $T_C = 25^\circ\text{C}$ $T_C = 100^\circ\text{C}$	$I_F$	36.0 21.0	A
Diode pulsed current, $t_p$ limited by $T_{vjmax}$	$I_{Fpuls}$	120.0	A
Gate-emitter voltage Transient Gate-emitter voltage ( $t_p = 10\mu\text{s}$ , $D < 0.010$ )	$V_{GE}$	$\pm 20$ $\pm 30$	V
Power dissipation $T_C = 25^\circ\text{C}$ Power dissipation $T_C = 100^\circ\text{C}$	$P_{tot}$	255.0 120.0	W
Operating junction temperature	$T_{vj}$	-40...+175	$^\circ\text{C}$
Storage temperature	$T_{stg}$	-55...+150	$^\circ\text{C}$
Soldering temperature, wave soldering 1.6 mm (0.063 in.) from case for 10s	PG-TO247-3 PG-TO220-3	260 260	$^\circ\text{C}$
Mounting torque, M3 screw Maximum of mounting processes: 3	$M$	0.6	Nm

**Thermal Resistance**

Parameter	Symbol	Conditions	Max. Value	Unit
<b>Characteristic</b>				
IGBT thermal resistance, junction - case	$R_{th(j-c)}$		0.60	K/W
Diode thermal resistance, junction - case	$R_{th(j-c)}$		1.80	K/W
Thermal resistance junction - ambient	$R_{th(j-a)}$	PG-TO247-3 PG-TO220-3	40 62	K/W

**Electrical Characteristic, at  $T_{vj} = 25^{\circ}\text{C}$ , unless otherwise specified**

Parameter	Symbol	Conditions	Value			Unit
			min.	typ.	max.	
<b>Static Characteristic</b>						
Collector-emitter breakdown voltage	$V_{(BR)CES}$	$V_{GE} = 0\text{V}, I_C = 0.20\text{mA}$	650	-	-	V
Collector-emitter saturation voltage	$V_{CEsat}$	$V_{GE} = 15.0\text{V}, I_C = 40.0\text{A}$ $T_{vj} = 25^{\circ}\text{C}$ $T_{vj} = 125^{\circ}\text{C}$ $T_{vj} = 175^{\circ}\text{C}$	- - -	1.60 1.80 1.90	2.10 - -	V
Diode forward voltage	$V_F$	$V_{GE} = 0\text{V}, I_F = 20.0\text{A}$ $T_{vj} = 25^{\circ}\text{C}$ $T_{vj} = 125^{\circ}\text{C}$ $T_{vj} = 175^{\circ}\text{C}$	- - -	1.45 1.40 1.40	1.80 - -	V
Gate-emitter threshold voltage	$V_{GE(th)}$	$I_C = 0.40\text{mA}, V_{CE} = V_{GE}$	3.2	4.0	4.8	V
Zero gate voltage collector current	$I_{CES}$	$V_{CE} = 650\text{V}, V_{GE} = 0\text{V}$ $T_{vj} = 25^{\circ}\text{C}$ $T_{vj} = 175^{\circ}\text{C}$	- -	- -	40.0 4000.0	$\mu\text{A}$
Gate-emitter leakage current	$I_{GES}$	$V_{CE} = 0\text{V}, V_{GE} = 20\text{V}$	-	-	100	nA
Transconductance	$g_{fs}$	$V_{CE} = 20\text{V}, I_C = 40.0\text{A}$	-	50.0	-	S

**Electrical Characteristic, at  $T_{vj} = 25^{\circ}\text{C}$ , unless otherwise specified**

Parameter	Symbol	Conditions	Value			Unit
			min.	typ.	max.	
<b>Dynamic Characteristic</b>						
Input capacitance	$C_{ies}$	$V_{CE} = 25\text{V}, V_{GE} = 0\text{V}, f = 1\text{MHz}$	-	2500	-	pF
Output capacitance	$C_{oes}$		-	50	-	
Reverse transfer capacitance	$C_{res}$		-	9	-	
Gate charge	$Q_G$	$V_{CC} = 520\text{V}, I_C = 40.0\text{A},$ $V_{GE} = 15\text{V}$	-	95.0	-	nC
Internal emitter inductance measured 5mm (0.197 in.) from case	$L_E$	PG-TO247-3 PG-TO220-3	-	13.0	-	nH

**Switching Characteristic, Inductive Load, at  $T_{vj} = 25^{\circ}\text{C}$** 

Parameter	Symbol	Conditions	Value			Unit
			min.	typ.	max.	
<b>IGBT Characteristic</b>						
Turn-on delay time	$t_{d(on)}$	$T_{vj} = 25^{\circ}\text{C},$ $V_{CC} = 400\text{V}, I_C = 20.0\text{A},$ $V_{GE} = 0.0/15.0\text{V},$ $r_G = 15.0\Omega, L_{\sigma} = 30\text{nH},$ $C_{\sigma} = 30\text{pF}$ $L_{\sigma}, C_{\sigma}$ from Fig. E Energy losses include "tail" and diode reverse recovery.	-	19	-	ns
Rise time	$t_r$		-	13	-	ns
Turn-off delay time	$t_{d(off)}$		-	160	-	ns
Fall time	$t_f$		-	16	-	ns
Turn-on energy	$E_{on}$		-	0.36	-	mJ
Turn-off energy	$E_{off}$		-	0.10	-	mJ
Total switching energy	$E_{ts}$		-	0.46	-	mJ

Turn-on delay time	$t_{d(on)}$	$T_{vj} = 25^{\circ}\text{C}$ , $V_{CC} = 400\text{V}$ , $I_C = 5.0\text{A}$ , $V_{GE} = 0.0/15.0\text{V}$ , $r_G = 15.0\Omega$ , $L\sigma = 30\text{nH}$ , $C\sigma = 30\text{pF}$ $L\sigma$ , $C\sigma$ from Fig. E Energy losses include "tail" and diode reverse recovery.	-	20	-	ns
Rise time	$t_r$		-	4	-	ns
Turn-off delay time	$t_{d(off)}$		-	175	-	ns
Fall time	$t_f$		-	10	-	ns
Turn-on energy	$E_{on}$		-	0.07	-	mJ
Turn-off energy	$E_{off}$		-	0.03	-	mJ
Total switching energy	$E_{ts}$		-	0.10	-	mJ

**Diode Characteristic, at  $T_{vj} = 25^{\circ}\text{C}$** 

Diode reverse recovery time	$t_{rr}$	$T_{vj} = 25^{\circ}\text{C}$ , $V_R = 400\text{V}$ , $I_F = 20.0\text{A}$ , $di_F/dt = 1000\text{A}/\mu\text{s}$	-	60	-	ns
Diode reverse recovery charge	$Q_{rr}$		-	0.45	-	$\mu\text{C}$
Diode peak reverse recovery current	$I_{rrm}$		-	12.4	-	A
Diode peak rate of fall of reverse recovery current during $t_b$	$di_{rr}/dt$		-	-280	-	$\text{A}/\mu\text{s}$
Diode reverse recovery time	$t_{rr}$	$T_{vj} = 25^{\circ}\text{C}$ , $V_R = 400\text{V}$ , $I_F = 5.0\text{A}$ , $di_F/dt = 1000\text{A}/\mu\text{s}$	-	33	-	ns
Diode reverse recovery charge	$Q_{rr}$		-	0.22	-	$\mu\text{C}$
Diode peak reverse recovery current	$I_{rrm}$		-	10.6	-	A
Diode peak rate of fall of reverse recovery current during $t_b$	$di_{rr}/dt$		-	-1030	-	$\text{A}/\mu\text{s}$

**Switching Characteristic, Inductive Load, at  $T_{vj} = 150^{\circ}\text{C}$** 

Parameter	Symbol	Conditions	Value			Unit
			min.	typ.	max.	
<b>IGBT Characteristic</b>						
Turn-on delay time	$t_{d(on)}$	$T_{vj} = 150^{\circ}\text{C}$ , $V_{CC} = 400\text{V}$ , $I_C = 20.0\text{A}$ , $V_{GE} = 0.0/15.0\text{V}$ , $r_G = 15.0\Omega$ , $L\sigma = 30\text{nH}$ , $C\sigma = 30\text{pF}$ $L\sigma$ , $C\sigma$ from Fig. E Energy losses include "tail" and diode reverse recovery.	-	20	-	ns
Rise time	$t_r$		-	14	-	ns
Turn-off delay time	$t_{d(off)}$		-	185	-	ns
Fall time	$t_f$		-	15	-	ns
Turn-on energy	$E_{on}$		-	0.50	-	mJ
Turn-off energy	$E_{off}$		-	0.16	-	mJ
Total switching energy	$E_{ts}$		-	0.66	-	mJ
Turn-on delay time	$t_{d(on)}$	$T_{vj} = 150^{\circ}\text{C}$ , $V_{CC} = 400\text{V}$ , $I_C = 5.0\text{A}$ , $V_{GE} = 0.0/15.0\text{V}$ , $r_G = 15.0\Omega$ , $L\sigma = 30\text{nH}$ , $C\sigma = 30\text{pF}$ $L\sigma$ , $C\sigma$ from Fig. E Energy losses include "tail" and diode reverse recovery.	-	18	-	ns
Rise time	$t_r$		-	5	-	ns
Turn-off delay time	$t_{d(off)}$		-	220	-	ns
Fall time	$t_f$		-	12	-	ns
Turn-on energy	$E_{on}$		-	0.14	-	mJ
Turn-off energy	$E_{off}$		-	0.05	-	mJ
Total switching energy	$E_{ts}$		-	0.19	-	mJ

**Diode Characteristic, at  $T_{vj} = 150^{\circ}\text{C}$**

Diode reverse recovery time	$t_{rr}$	$T_{vj} = 150^{\circ}\text{C},$ $V_R = 400\text{V},$ $I_F = 20.0\text{A},$ $di_F/dt = 1000\text{A}/\mu\text{s}$	-	85	-	ns
Diode reverse recovery charge	$Q_{rr}$		-	1.00	-	$\mu\text{C}$
Diode peak reverse recovery current	$I_{rrm}$		-	17.0	-	A
Diode peak rate of fall of reverse recovery current during $t_b$	$di_{rr}/dt$		-	-220	-	$\text{A}/\mu\text{s}$
Diode reverse recovery time	$t_{rr}$	$T_{vj} = 150^{\circ}\text{C},$ $V_R = 400\text{V},$ $I_F = 5.0\text{A},$ $di_F/dt = 1000\text{A}/\mu\text{s}$	-	50	-	ns
Diode reverse recovery charge	$Q_{rr}$		-	0.50	-	$\mu\text{C}$
Diode peak reverse recovery current	$I_{rrm}$		-	14.0	-	A
Diode peak rate of fall of reverse recovery current during $t_b$	$di_{rr}/dt$		-	-500	-	$\text{A}/\mu\text{s}$

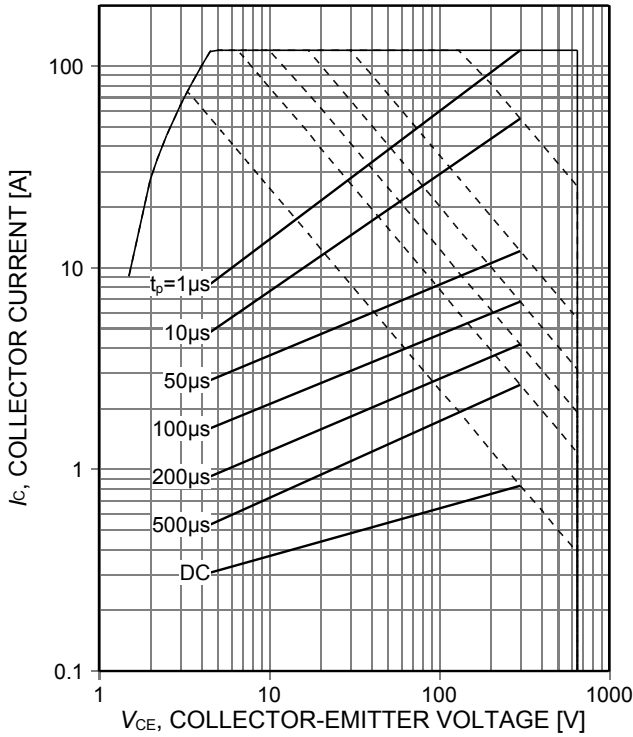


Figure 1. **Forward bias safe operating area**  
 ( $D=0$ ,  $T_C=25^\circ\text{C}$ ,  $T_{vj}\leq 175^\circ\text{C}$ ;  $V_{GE}=15\text{V}$ .  
 Recommended use at  $V_{GE}\geq 7.5\text{V}$ )

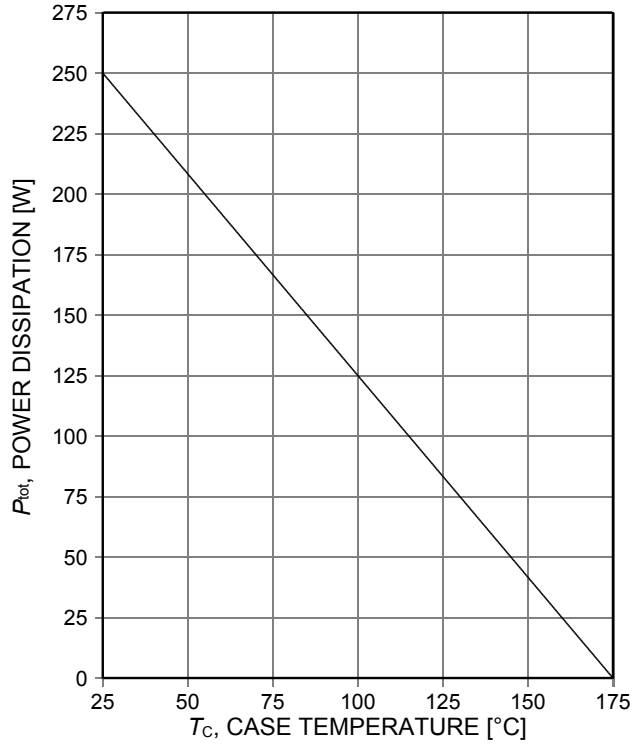


Figure 2. **Power dissipation as a function of case temperature**  
 ( $T_{vj}\leq 175^\circ\text{C}$ )

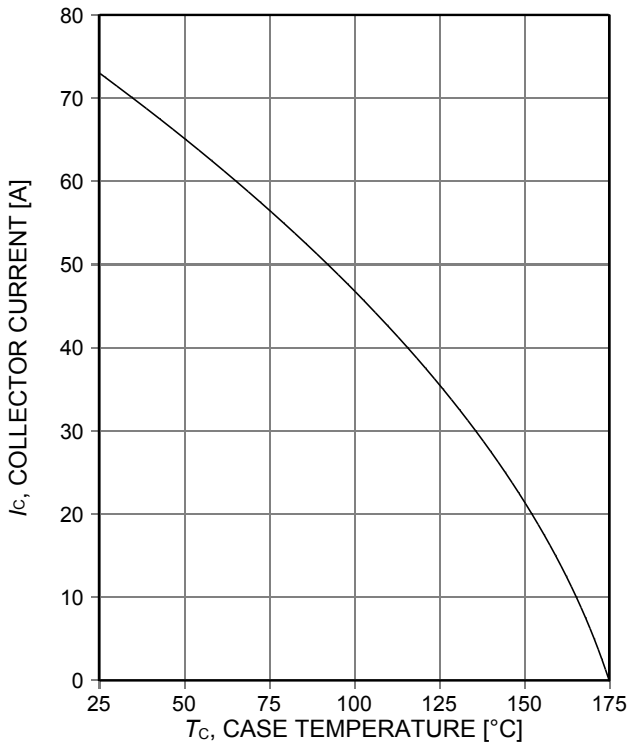


Figure 3. **Collector current as a function of case temperature**  
 ( $V_{GE}\geq 15\text{V}$ ,  $T_{vj}\leq 175^\circ\text{C}$ )

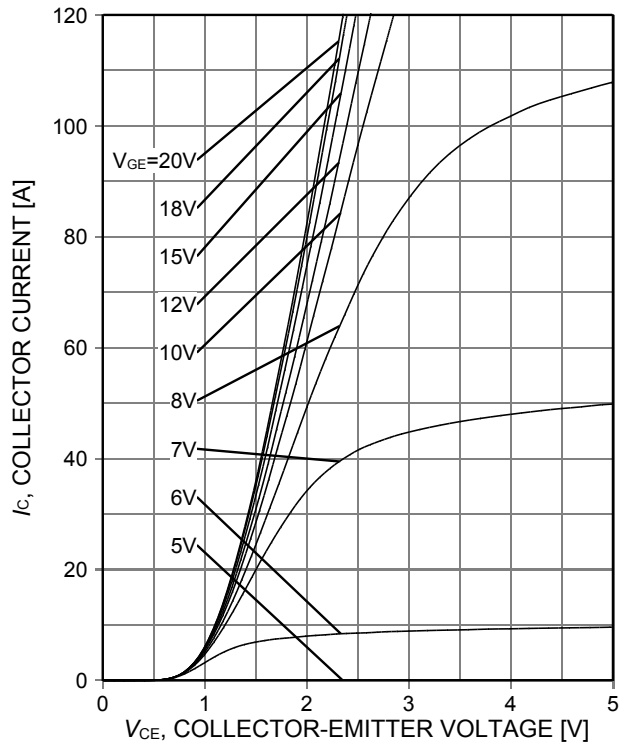


Figure 4. **Typical output characteristic**  
 ( $T_{vj}=25^\circ\text{C}$ )



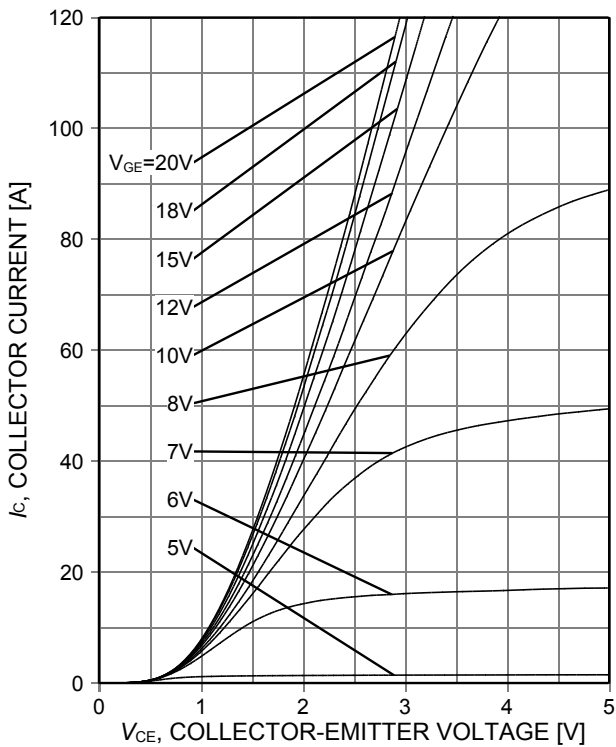


Figure 5. **Typical output characteristic**  
( $T_{vj}=150^{\circ}\text{C}$ )

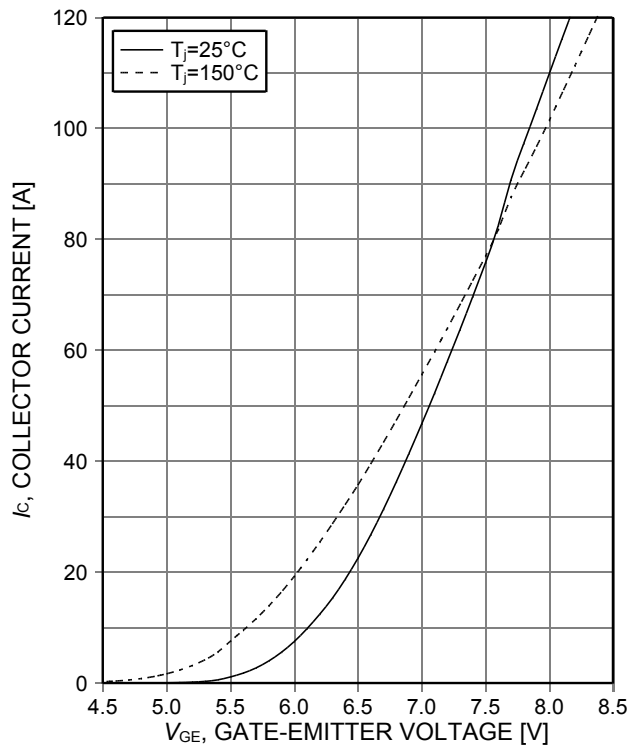


Figure 6. **Typical transfer characteristic**  
( $V_{CE}=20\text{V}$ )

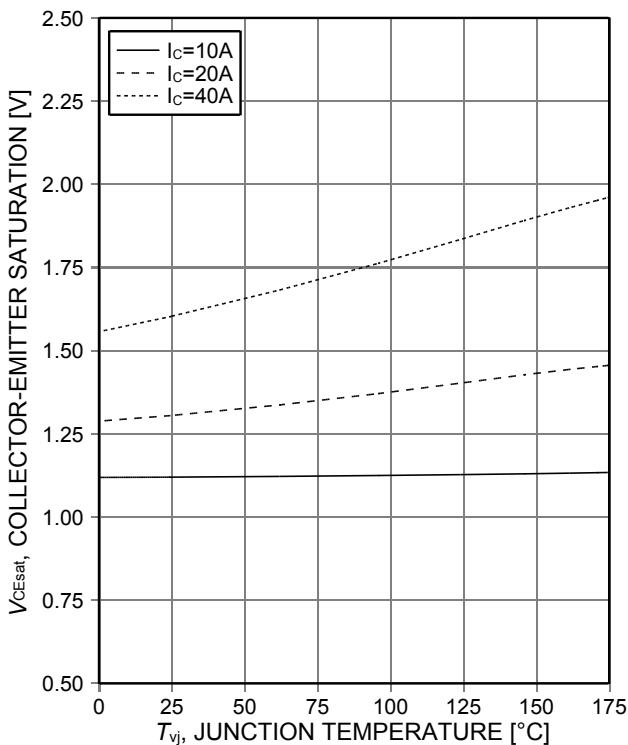


Figure 7. **Typical collector-emitter saturation voltage as a function of junction temperature**  
( $V_{GE}=15\text{V}$ )

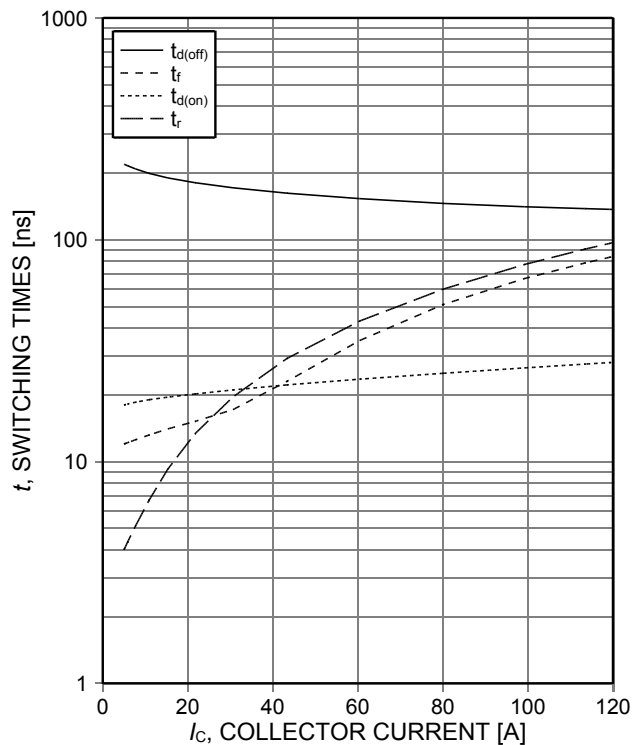


Figure 8. **Typical switching times as a function of collector current**  
(inductive load,  $T_{vj}=150^{\circ}\text{C}$ ,  $V_{CE}=400\text{V}$ ,  $V_{GE}=15/0\text{V}$ ,  $r_G=15\Omega$ , Dynamic test circuit in Figure E)

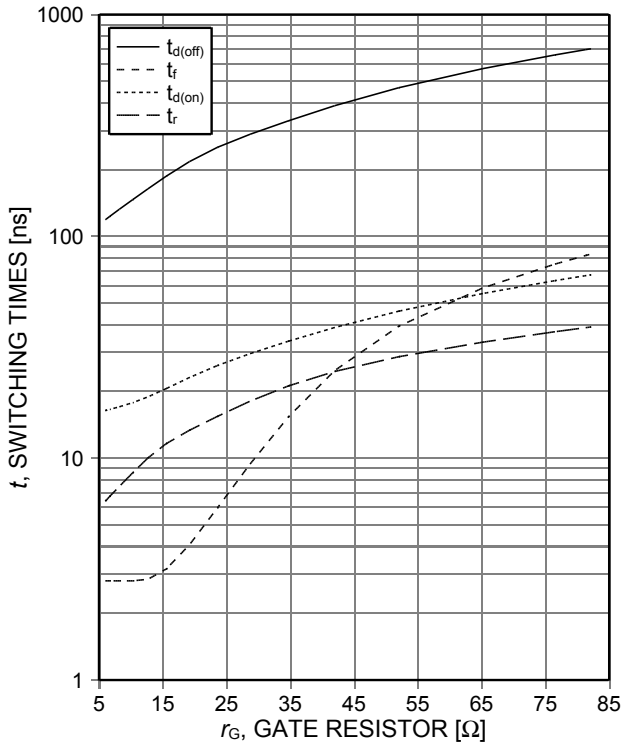


Figure 9. **Typical switching times as a function of gate resistor**  
 (inductive load,  $T_{vj}=150^{\circ}\text{C}$ ,  $V_{CE}=400\text{V}$ ,  $V_{GE}=15/0\text{V}$ ,  $I_C=20\text{A}$ , Dynamic test circuit in Figure E)

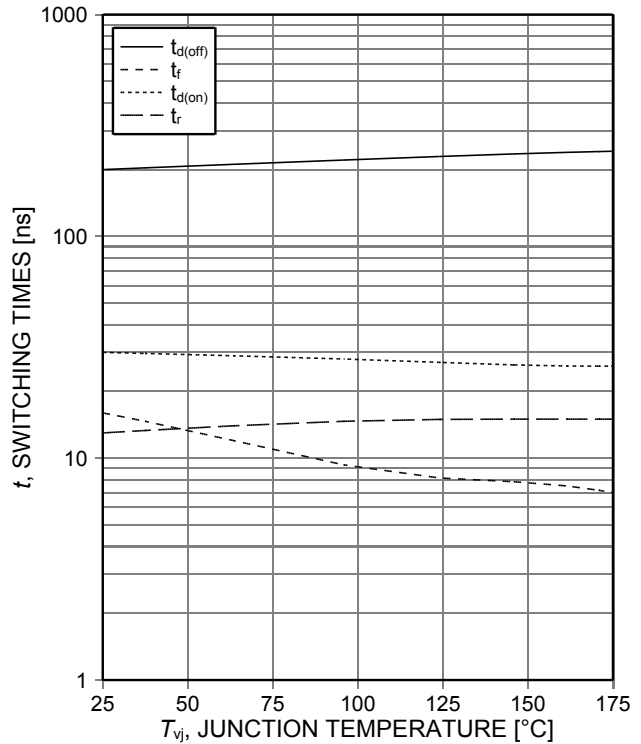


Figure 10. **Typical switching times as a function of junction temperature**  
 (inductive load,  $V_{CE}=400\text{V}$ ,  $V_{GE}=15/0\text{V}$ ,  $I_C=20\text{A}$ ,  $r_G=15\Omega$ , Dynamic test circuit in Figure E)

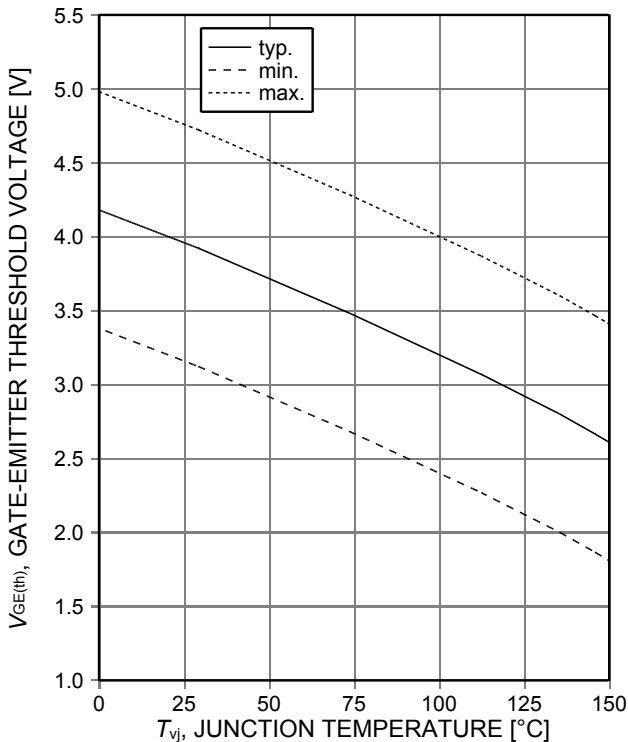


Figure 11. **Gate-emitter threshold voltage as a function of junction temperature**  
 ( $I_C=0.4\text{mA}$ )

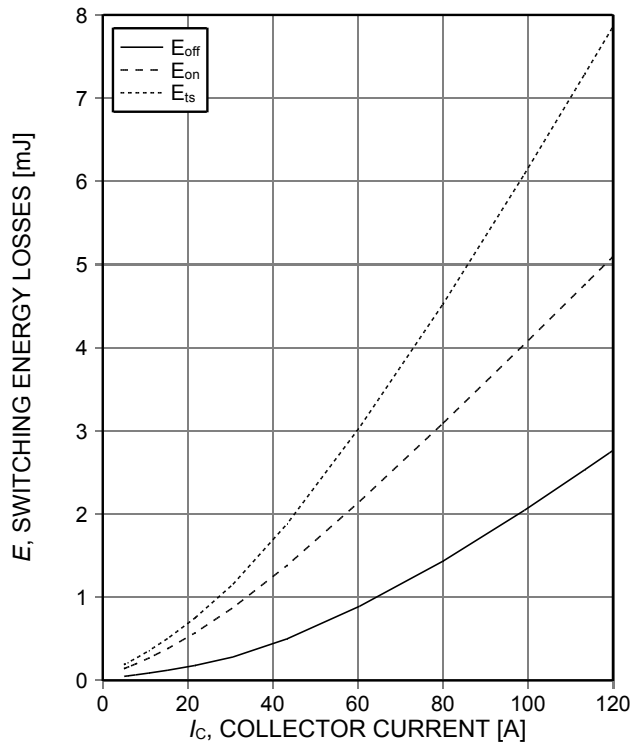


Figure 12. **Typical switching energy losses as a function of collector current**  
 (inductive load,  $T_{vj}=150^{\circ}\text{C}$ ,  $V_{CE}=400\text{V}$ ,  $V_{GE}=15/0\text{V}$ ,  $r_G=15\Omega$ , Dynamic test circuit in Figure E)

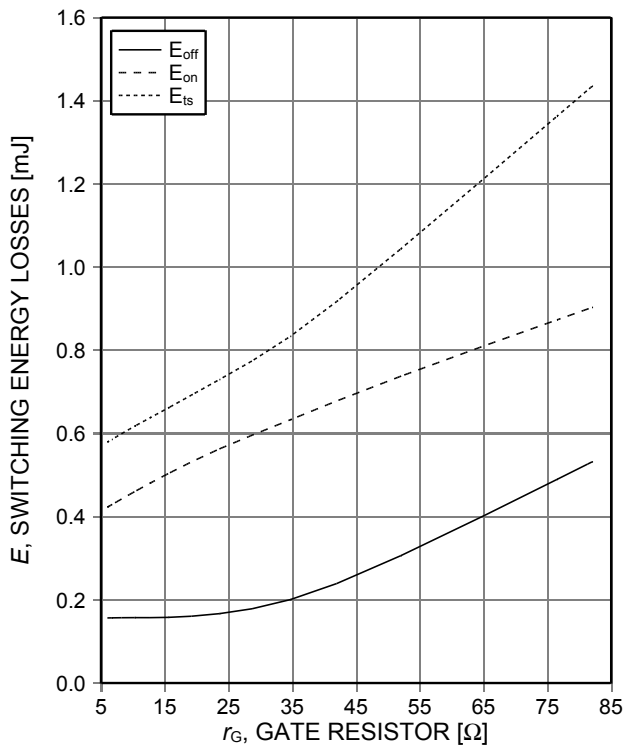


Figure 13. **Typical switching energy losses as a function of gate resistor**  
 (inductive load,  $T_{vj}=150^{\circ}\text{C}$ ,  $V_{CE}=400\text{V}$ ,  $V_{GE}=15/0\text{V}$ ,  $I_C=20\text{A}$ , Dynamic test circuit in Figure E)

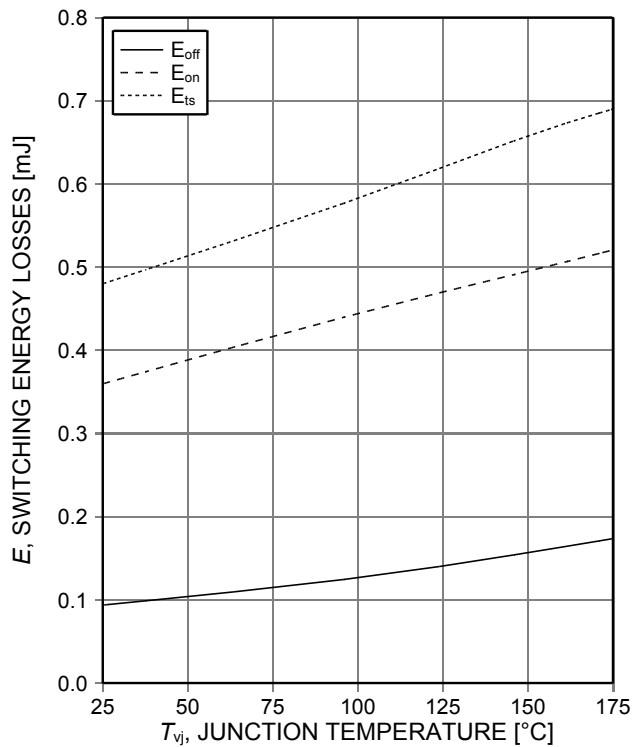


Figure 14. **Typical switching energy losses as a function of junction temperature**  
 (inductive load,  $V_{CE}=400\text{V}$ ,  $V_{GE}=15/0\text{V}$ ,  $I_C=20\text{A}$ ,  $r_G=15\Omega$ , Dynamic test circuit in Figure E)

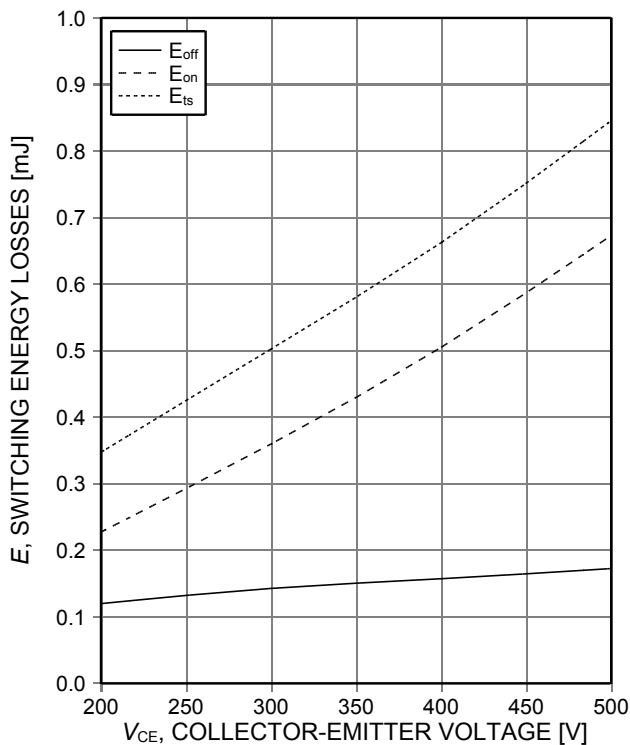


Figure 15. **Typical switching energy losses as a function of collector emitter voltage**  
 (inductive load,  $T_{vj}=150^{\circ}\text{C}$ ,  $V_{GE}=15/0\text{V}$ ,  $I_C=20\text{A}$ ,  $r_G=15\Omega$ , Dynamic test circuit in Figure E)

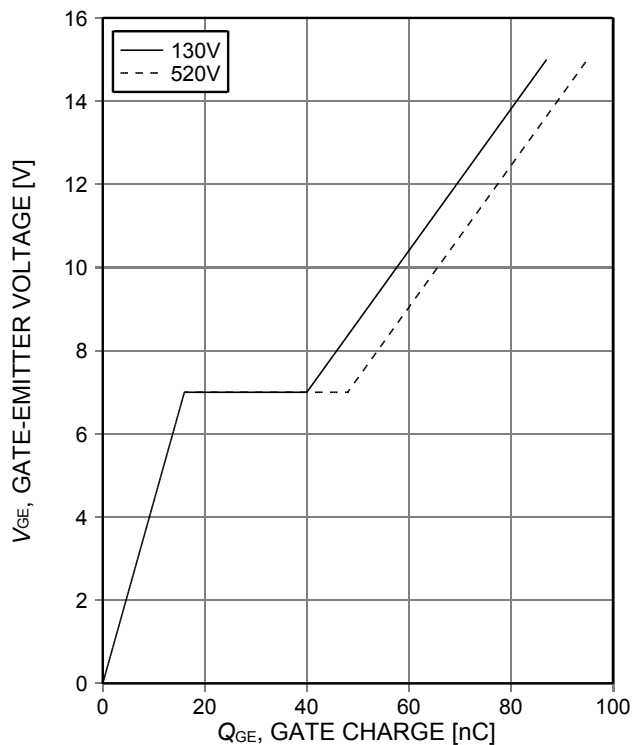


Figure 16. **Typical gate charge**  
 ( $I_C=40\text{A}$ )

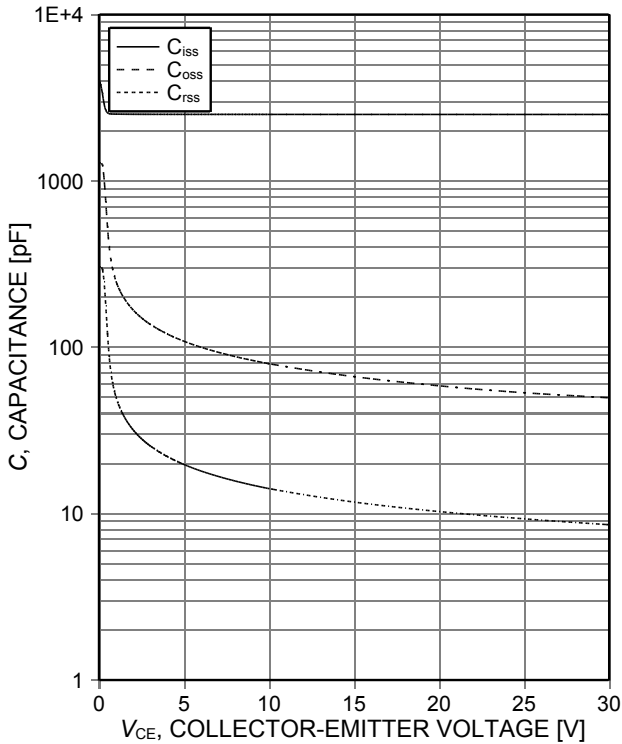


Figure 17. Typical capacitance as a function of collector-emitter voltage ( $V_{GE}=0V, f=1MHz$ )

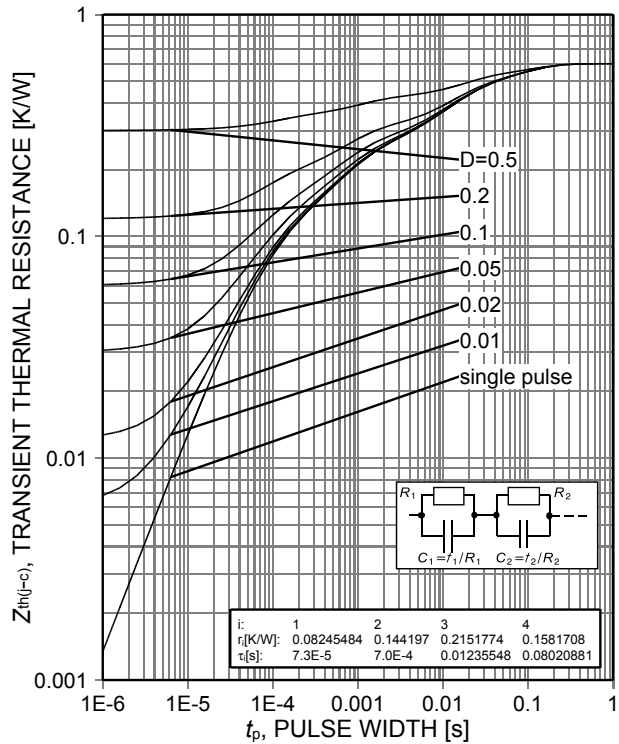


Figure 18. IGBT transient thermal resistance ( $D=t_p/T$ )

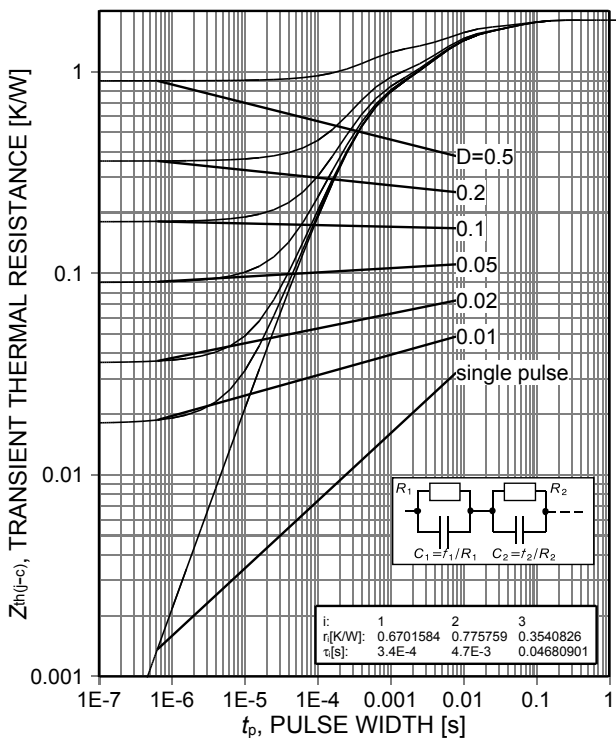


Figure 19. Diode transient thermal impedance as a function of pulse width ( $D=t_p/T$ )

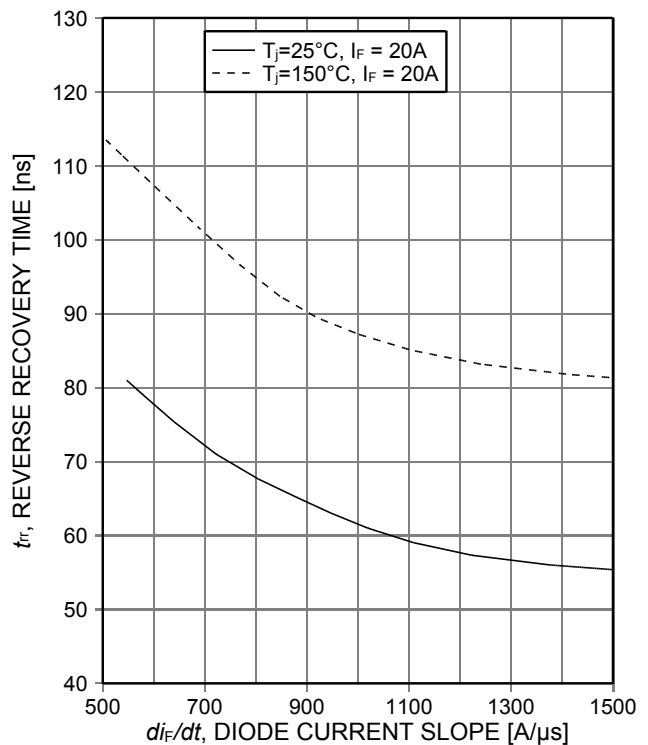


Figure 20. Typical reverse recovery time as a function of diode current slope ( $V_R=400V$ )

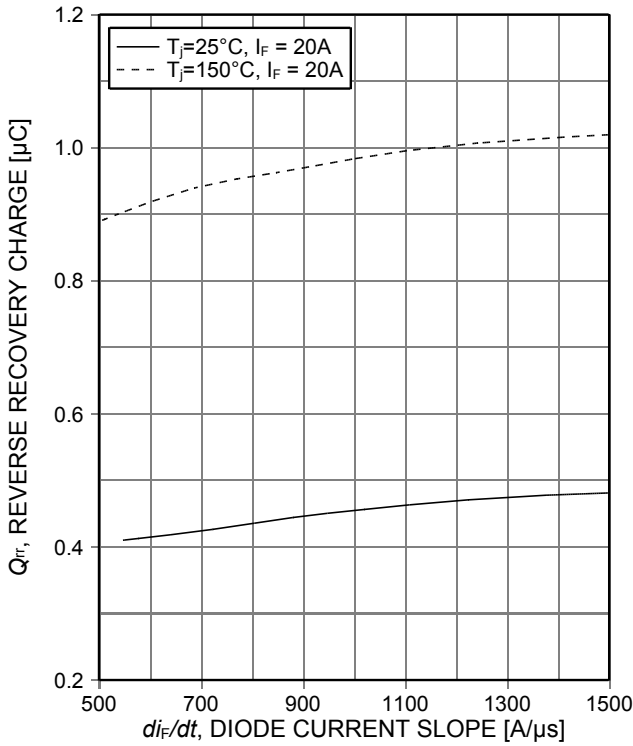


Figure 21. Typical reverse recovery charge as a function of diode current slope ( $V_R=400V$ )

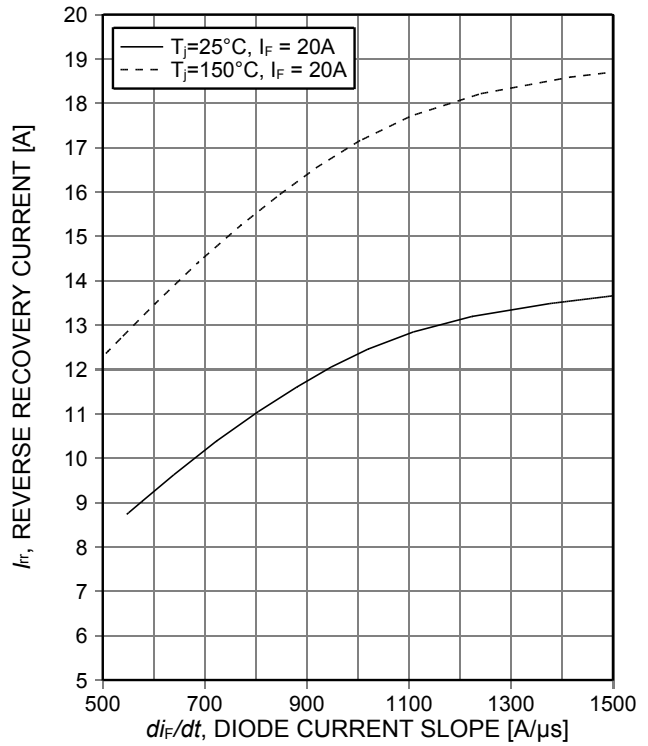


Figure 22. Typical reverse recovery current as a function of diode current slope ( $V_R=400V$ )

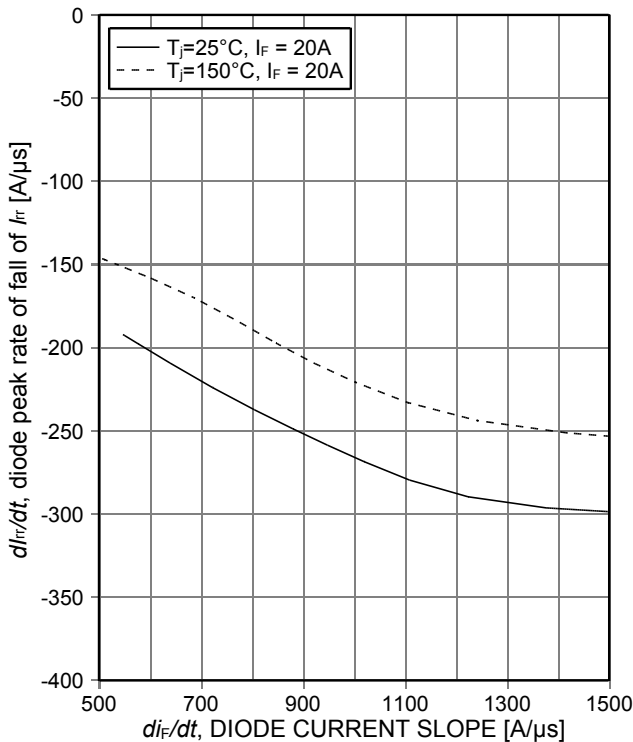


Figure 23. Typical diode peak rate of fall of reverse recovery current as a function of diode current slope ( $V_R=400V$ )

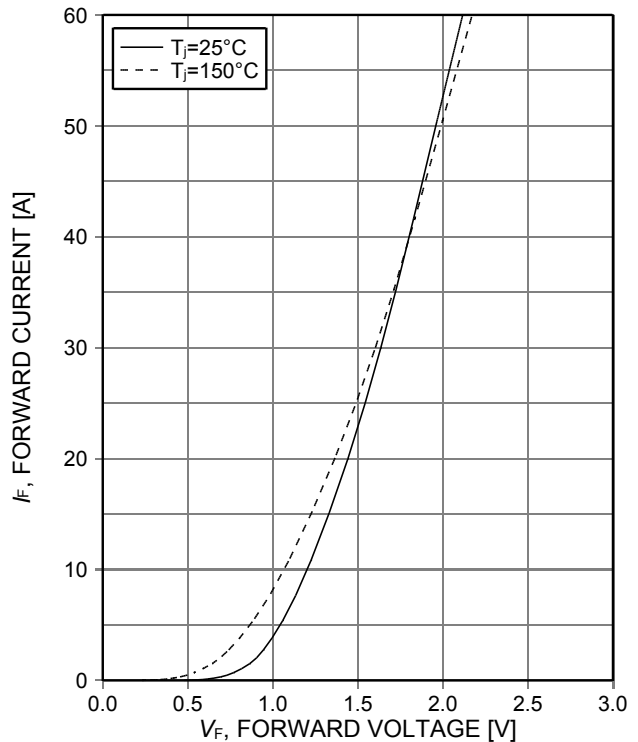


Figure 24. Typical diode forward current as a function of forward voltage

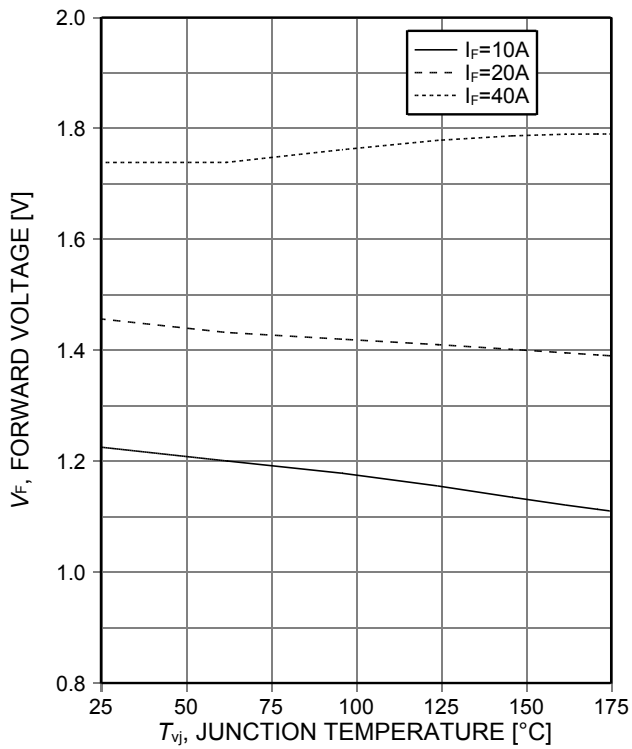
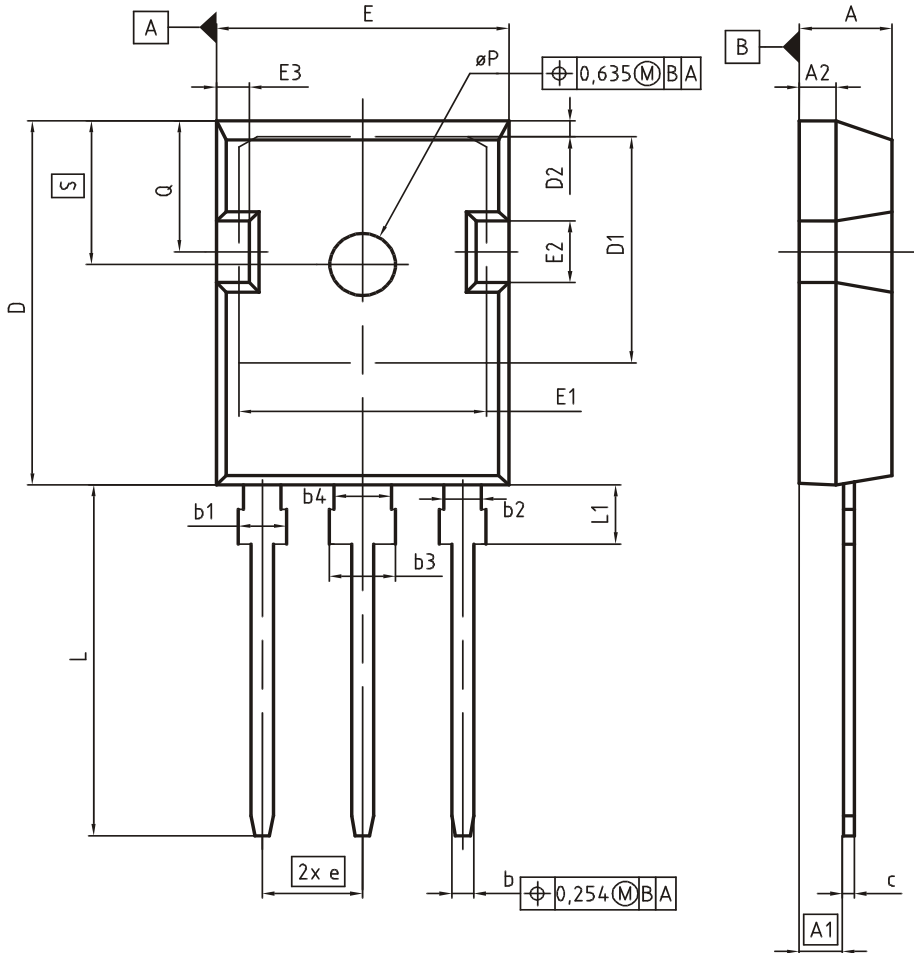


Figure 25. Typical diode forward voltage as a function of junction temperature

### PG-TO247-3



DIM	MILLIMETERS		INCHES	
	MIN	MAX	MIN	MAX
A	4.83	5.21	0.190	0.205
A1	2.27	2.54	0.089	0.100
A2	1.85	2.16	0.073	0.085
b	1.07	1.33	0.042	0.052
b1	1.90	2.41	0.075	0.095
b2	1.90	2.16	0.075	0.085
b3	2.87	3.38	0.113	0.133
b4	2.87	3.13	0.113	0.123
c	0.55	0.68	0.022	0.027
D	20.80	21.10	0.819	0.831
D1	16.25	17.65	0.640	0.695
D2	0.95	1.35	0.037	0.053
E	15.70	16.13	0.618	0.635
E1	13.10	14.15	0.516	0.557
E2	3.68	5.10	0.145	0.201
E3	1.00	2.60	0.039	0.102
e	5.44 (BSC)		0.214 (BSC)	
N	3		3	
L	19.80	20.32	0.780	0.800
L1	4.10	4.47	0.161	0.176
$\phi P$	3.50	3.70	0.138	0.146
Q	5.49	6.00	0.216	0.236
S	6.04	6.30	0.238	0.248

**DOCUMENT NO.**  
Z8B00003327

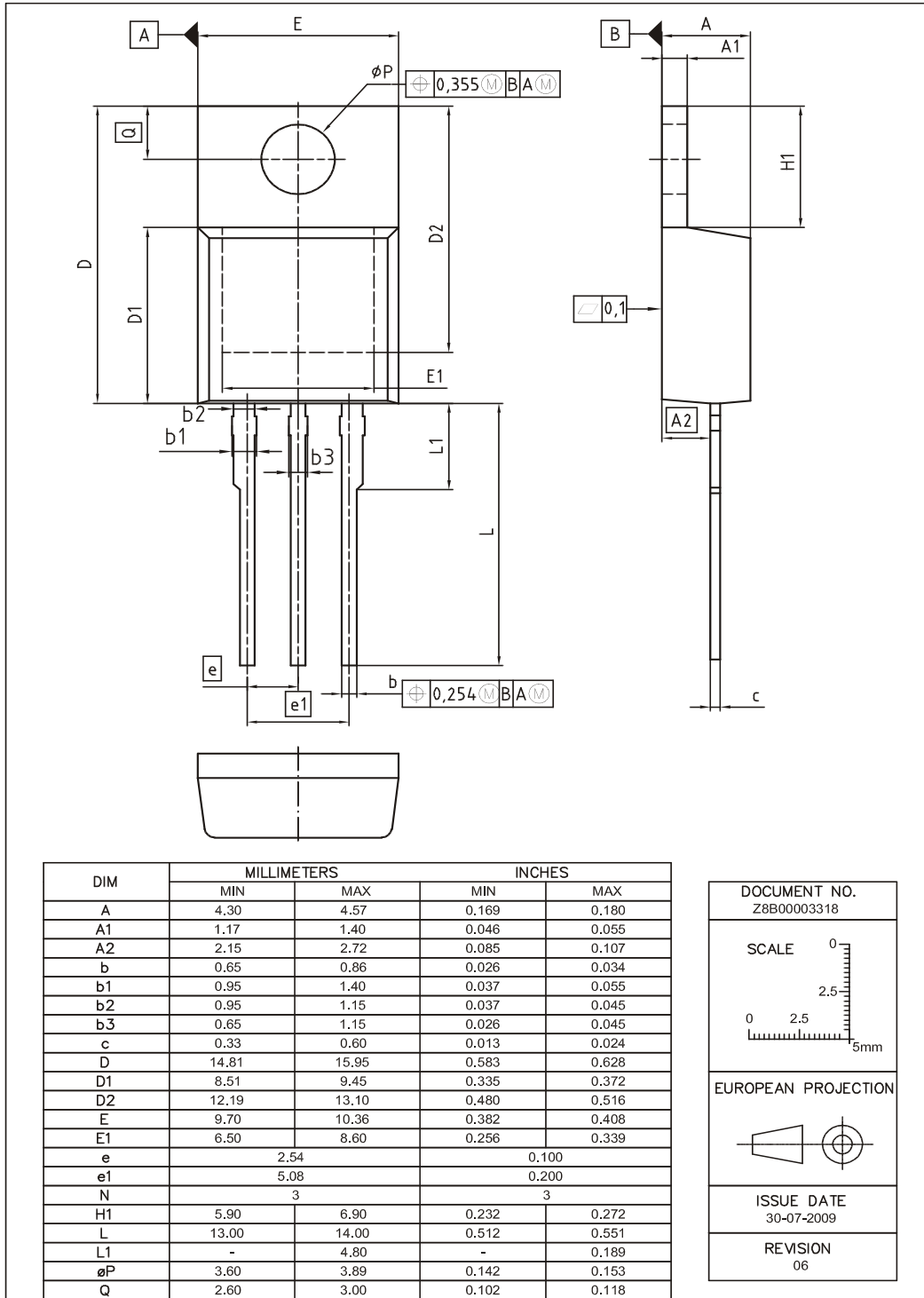
**SCALE**

**EUROPEAN PROJECTION**

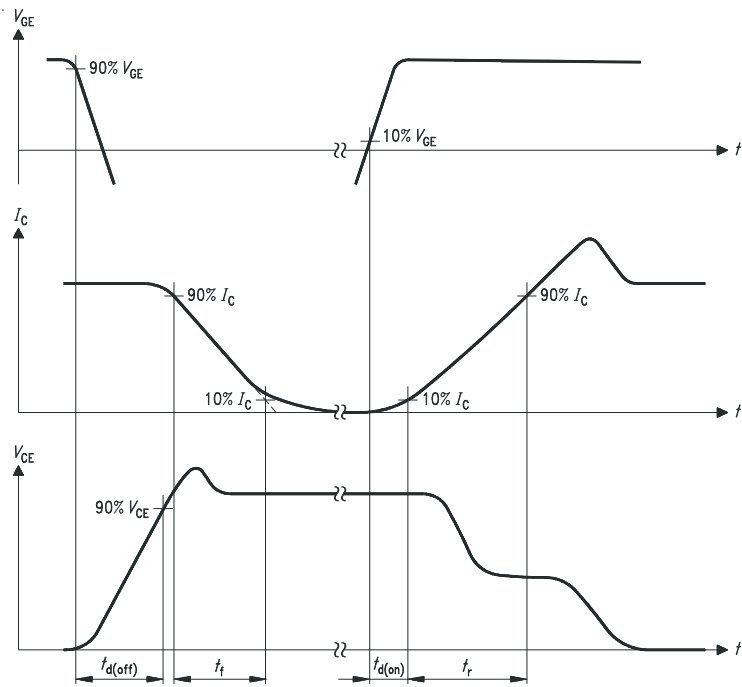
**ISSUE DATE**  
09-07-2010

**REVISION**  
05

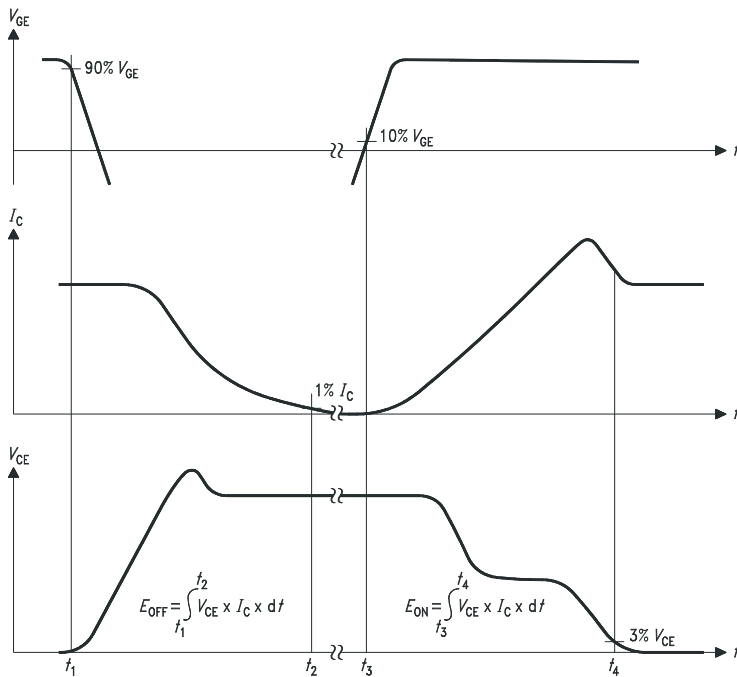
### PG-TO220-3



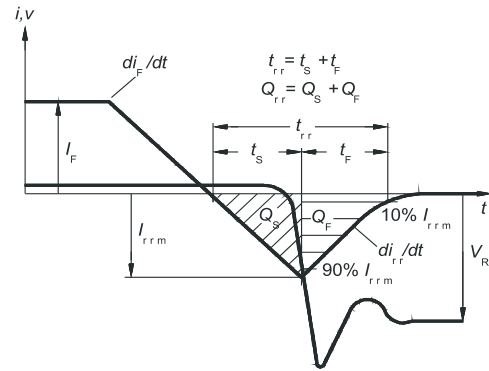




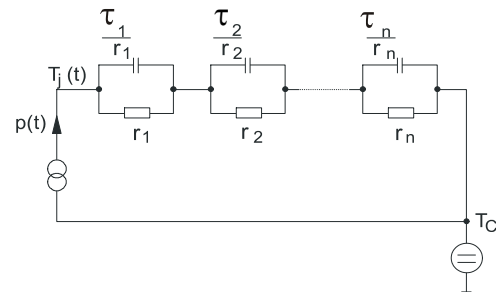
**Figure A. Definition of switching times**



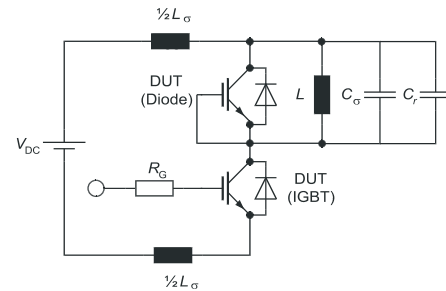
**Figure B. Definition of switching losses**



**Figure C. Definition of diodes switching characteristics**



**Figure D. Thermal equivalent circuit**



**Figure E. Dynamic test circuit**  
 Parasitic inductance  $L_\sigma$ ,  
 Parasitic capacitor  $C_\sigma$ ,  
 Relief capacitor  $C_r$   
 (only for ZVT switching)

**Revision History**

IKW40N65F5, IKP40N65F5

**Revision: 2012-11-09, Rev. 1.1**

Previous Revision

Revision	Date	Subjects (major changes since last revision)
1.1	2012-11-09	Preliminary data sheet

**We Listen to Your Comments**

Any information within this document that you feel is wrong, unclear or missing at all ?

Your feedback will help us to continuously improve the quality of this document.

Please send your proposal (including a reference to this document) to: [erratum@infineon.com](mailto:erratum@infineon.com)

**Published by****Infineon Technologies AG****81726 Munich, Germany****81726 München, Germany****© 2012 Infineon Technologies AG****All Rights Reserved.****Legal Disclaimer**

The information given in this document shall in no event be regarded as a guarantee of conditions or characteristics.

With respect to any examples or hints given herein, any typical values stated herein and/or any information regarding the application of the device, Infineon Technologies hereby disclaims any and all warranties and liabilities of any kind, including without limitation, warranties of non-infringement of intellectual property rights of any third party.

**Information**

For further information on technology, delivery terms and conditions and prices, please contact the nearest Infineon Technologies Office ([www.infineon.com](http://www.infineon.com)).

**Warnings**

Due to technical requirements, components may contain dangerous substances. For information on the types in question, please contact the nearest Infineon Technologies Office.

The Infineon Technologies component described in this Data Sheet may be used in life-support devices or systems and/or automotive, aviation and aerospace applications or systems only with the express written approval of Infineon Technologies, if a failure of such components can reasonably be expected to cause the failure of that life-support, automotive, aviation and aerospace device or system or to affect the safety or effectiveness of that device or system. Life support devices or systems are intended to be implanted in the human body or to support and/or maintain and sustain and/or protect human life. If they fail, it is reasonable to assume that the health of the user or other persons may be endangered.