

IFX7805

Three Terminal 1.0A Positive Voltage Regulator

Datasheet

Rev. 1.0, 2013-07-15

Standard Power



1 Overview

Features

- 1.0 A Output Current Capability
- High Input Voltage Range: up to 35 Volts
- Available in Fixed 5V Output Voltage Version
- Wide temperature range $T_j = -40\text{ °C to }+125\text{ °C}$
- Over temperature Protection
- Short Circuit Current Limit
- Safe-Area Protection
- Thermally Optimized Packages
- Green Product (RoHS compliant)

The IFX7805 is not qualified and manufactured according to the requirements of Infineon Technologies with regards to automotive and/or transportation applications. For automotive applications please refer to the Infineon TLx (TLE, TLS, TLF....) voltage regulator products.

Description

The IFX7805 monolithic 3-terminal positive voltage regulator employs internal current-limiting, thermal shutdown and safe-area compensation, making it extremely robust. The IFX7805 is available in a fixed 5V version and is capable of delivering an output current of 1A. These regulators can provide local on-card regulation, eliminating the distribution problems associated with single point regulation. This linear voltage regulator is designed for a wide variety of applications and suitable for use in harsh environments. The short-circuit current limit, limits the output current of the device. The safe-area protection feature limits the internal power dissipation, in case the internal power dissipation becomes too high, the thermal shutdown implemented prevents the device from overheating.

The 5V voltage regulator is available in the TO-252, TO-220 and TO-263 packages.

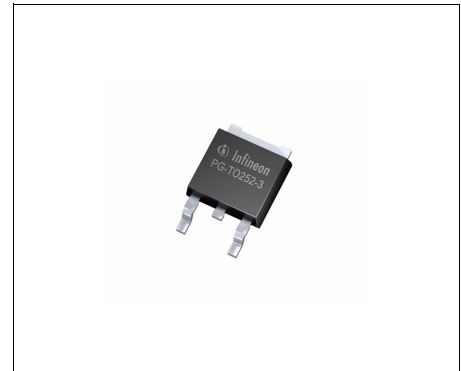

PG-TO-252-3

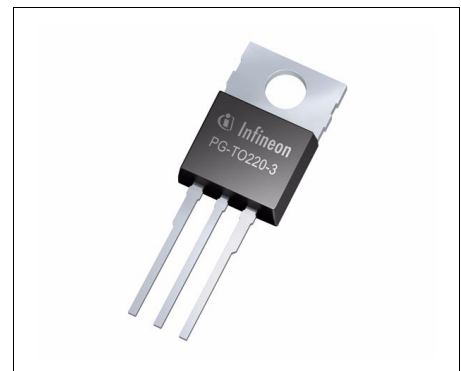

PG-TO-220-3

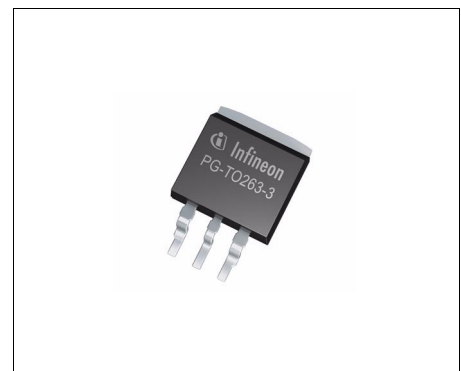

PG-TO-263-3

1.1 Ordering Information

Type	Package	Marking
IFX7805ABTF	PG-TO-252-3	I7805B
IFX7805ABTS	PG-TO-220-3	I7805BTS
IFX7805ABTC	PG-TO-263-3	I7805BTC

2 Block Diagram

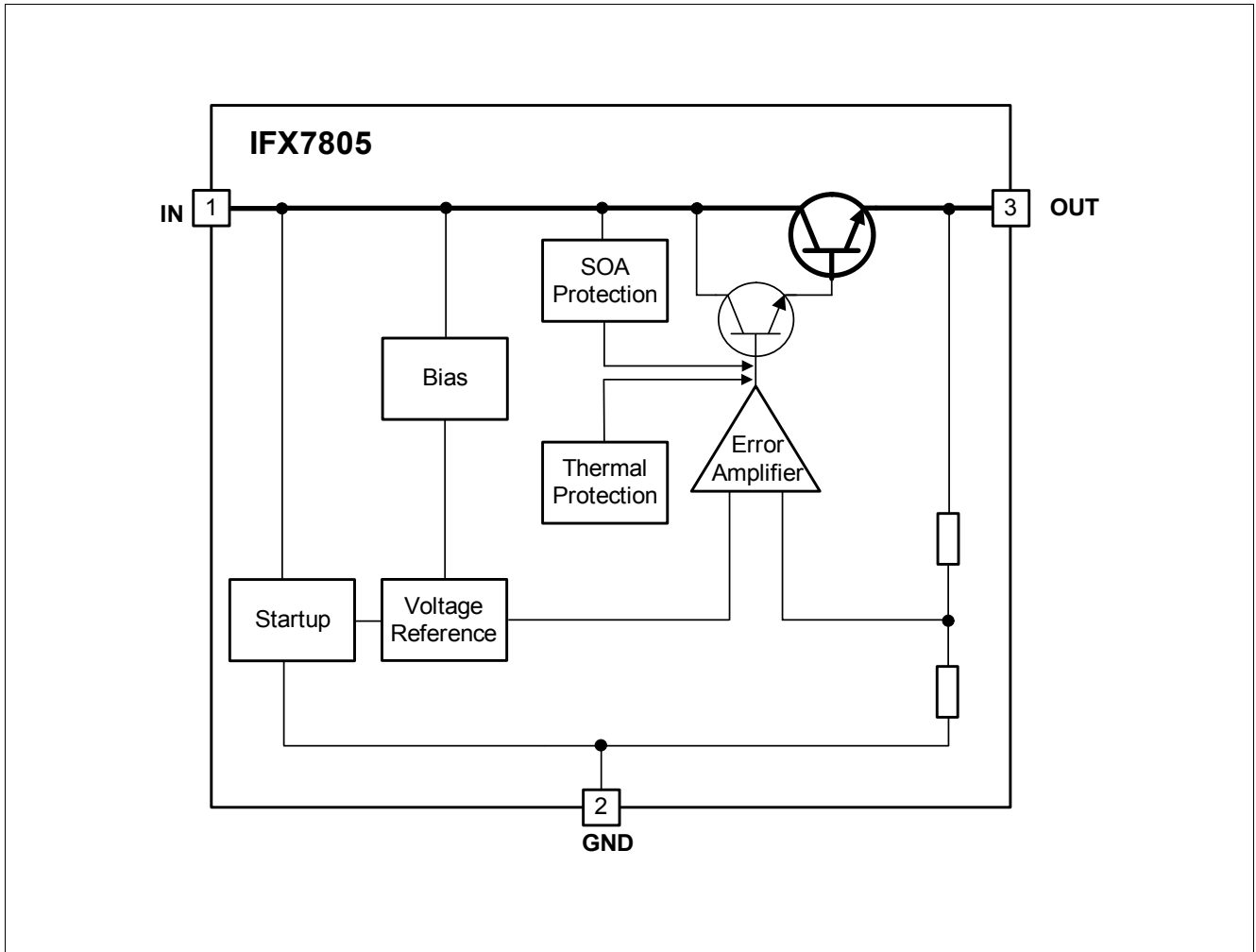

Figure 1 Block Diagram

3 Pin Configuration

3.1 Pin Assignment

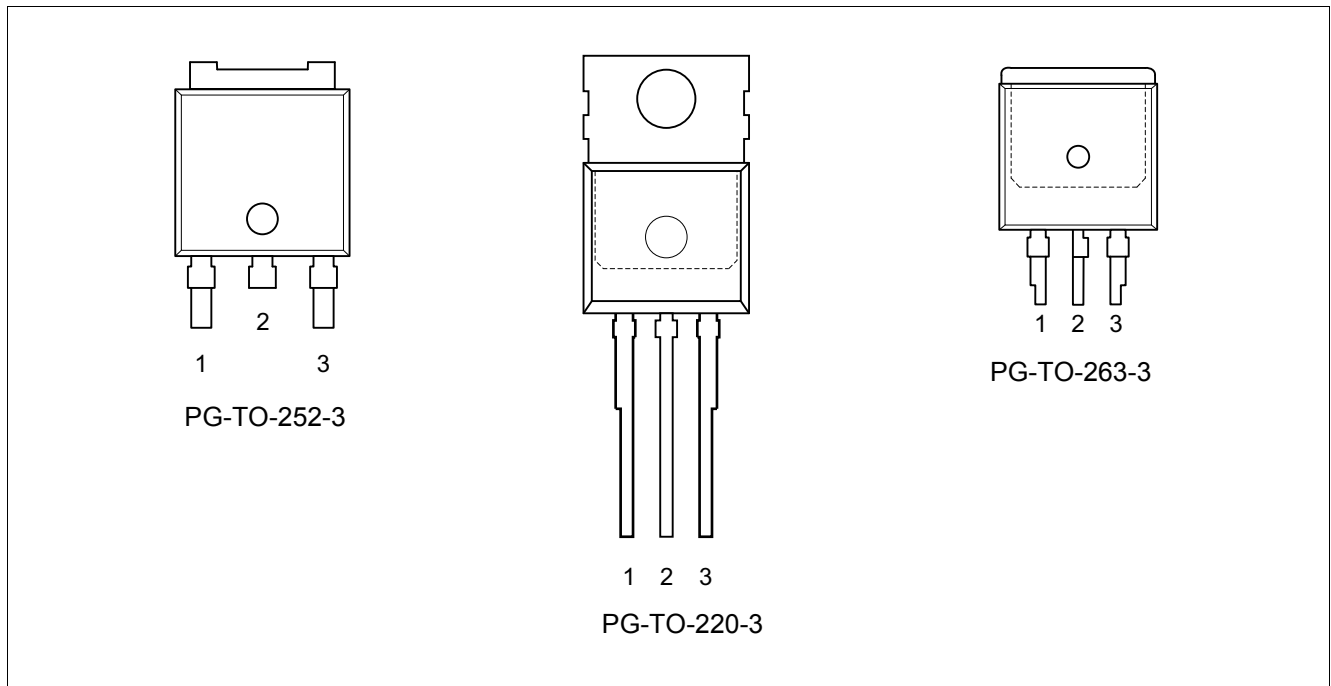

Figure 2 Pin Configuration

3.2 Pin Definitions and Functions

Pin	Symbol	Function
1	IN	Input The input pin is where the input power is supplied to the device. A capacitor is required from input to ground. Please refer to the application information section for more details. “Application Information” on Page 13
2	GND	Ground , Internally connected to thermal tab
3	OUT	Output The output voltage supplies power to the load. For stability a minimum output capacitor of 100nF is required from output to ground. Please refer to the application information section for more details. “Application Information” on Page 13

4 General Product Characteristics

4.1 Absolute Maximum Ratings

Table 1 Absolute Maximum Ratings ¹⁾

$T_j = -40\text{ °C}$ to $+125\text{ °C}$; all voltages with respect to ground, positive current flowing into pin (unless otherwise specified)

Pos.	Parameter	Symbol	Limit Values		Unit	Conditions
			Min.	Max.		
Voltage Input						
4.1.1	Voltage	V_{IN}	-0.3	35	V	–
Output Current						
4.1.2	Current	I_{OUT}	Internally Limited		A	–
Temperatures						
4.1.3	Junction Temperature	T_j	-40	150	°C	–
4.1.4	Storage Temperature	T_{stg}	-50	150	°C	–
ESD Susceptibility						
4.1.5	All Pins	V_{ESD}	-2	2	kV	HBM ²⁾
4.1.6	All Pins	V_{ESD}	-1	1	kV	CDM ³⁾

1) Not subject to production test, specified by design

2) ESD susceptibility, HBM according to ANSI/ESDA/JEDEC JS-001(1.5 kΩ, 100 pF)

3) ESD susceptibility, Charged Device Model “CDM” according to JEDEC JESD22-C101

Note: Stresses above the ones listed here may cause permanent damage to the device. Exposure to absolute maximum rating conditions for extended periods may affect device reliability.

Note: Integrated protection functions are designed to prevent IC destruction under fault conditions described in the data sheet. Fault conditions are considered as “outside” normal operating range. Protection functions are not designed for continuous repetitive operation.

4.2 Functional Range

Table 2 Functional Range

Pos.	Parameter	Symbol	Limit Values		Unit	Conditions
			Min.	Max.		
4.2.1	Input Voltage Range	V_{IN}	$V_{OUT} + V_{dr}$	35	V	¹⁾
4.2.2	Junction temperature	T_j	-40	125	°C	–

1) Output current is limited internally and depends on the maximum voltage, see Electrical Characteristics for more details.

Note: Within the functional or operating range, the IC operates as described in the circuit description. The electrical characteristics are specified within the conditions given in the Electrical Characteristics table.

4.3 Thermal Resistance

Note: This thermal data was generated in accordance with JEDEC JESD51 standards. For more information, go to www.jedec.org.

Pos.	Parameter	Symbol	Limit Values			Unit	Conditions
			Min.	Typ.	Max.		
PG-TO-252-3							
4.3.1	Junction to Case ¹⁾	R_{thJC}	–	4	–	K/W	–
4.3.2	Junction to Ambient	R_{thJA}	–	27	–	K/W	– ²⁾
4.3.3			–	113	–	K/W	Footprint Only
4.3.4			–	52	–	K/W	300mm ² heatsink area on PCB ³⁾
4.3.5			–	42	–	K/W	600mm ² heatsink area on PCB
PG-TO-263-3							
4.3.6	Junction to Case	R_{thJC}	–	4	–	K/W	–
4.3.7	Junction to Ambient	R_{thJA}	–	23	–	K/W	–
4.3.8			–	76	–	K/W	Footprint Only
4.3.9			–	44	–	K/W	300mm ² heatsink area on PCB
4.3.10			–	35	–	K/W	600mm ² heatsink area on PCB
PG-TO-220-3							
4.3.11	Junction to Case	R_{thJC}	–	4	–	K/W	–
4.3.12	Junction to Ambient	R_{thJA}	–	41	–	K/W	–
4.3.13			–	91	–	K/W	Footprint Only
4.3.14			–	63	–	K/W	300mm ² heatsink area on PCB
4.3.15			–	58	–	K/W	600mm ² heatsink area on PCB

1) Not subject to production test, specified by design.

2) Specified R_{thJA} value is according to JEDEC JESD51-5,-7 at natural convection on FR4 2s2p board. The product (chip and package) was simulated on a 76.2 x 114.3 x 1.5 mm³ board with 2 inner copper layers (2 x 70µm Cu, 2 x 35 µm Cu).

3) Specified R_{thJA} value is according to JEDEC JESD51-3 at natural convection on FR4 1s0p board. The product (chip and package) was simulated on a 76.2 x 114.3 x 1.5 mm³ board with 1 copper layer (1 x 70µm Cu)

5 Electrical Characteristics

5.1 IFX7805

Table 3 Electrical Characteristics
 $-40\text{ °C} < T_j < 125\text{ °C}$; $V_{IN} = 10\text{V}$, $C_{IN} = 0.33\mu\text{F}$, $C_{OUT} = 100\text{nF}$; unless otherwise specified.

Pos.	Parameter	Symbol	Limit Values			Unit	Test Condition
			Min.	Typ.	Max.		
5.1.1	Output Voltage	V_{OUT}	4.81	5.00	5.19	V	$I_{OUT} = 1\text{ A}$, $T_j = 25\text{ °C}$
5.1.2			4.80	5.00	5.20	V	$5\text{ mA} \leq I_{OUT} \leq 1\text{ A}$, $7.5\text{ V} \leq V_{IN} \leq 20\text{ V}$ $P_D \leq 15\text{ W}$
5.1.3	Line Regulation	$\Delta V_{OUT,LINE}$			4	mV	$I_{OUT} = 1\text{ A}$ $8\text{ V} \leq V_{IN} \leq 12\text{ V}$, $T_j = 25\text{ °C}$
5.1.4				1	10	mV	$I_{OUT} = 1\text{ A}$, $7.5\text{ V} \leq V_{IN} \leq 20\text{ V}$ $T_j = 25\text{ °C}$
5.1.5				3	10	mV	$I_{OUT} = 1\text{ A}$ $7.5\text{ V} \leq V_{IN} \leq 20\text{ V}$
5.1.6	Load Regulation	$\Delta V_{OUT,LOAD}$		10	15	mV	$5.0\text{ mA} \leq I_{OUT} \leq 1\text{ A}$, $T_j = 25\text{ °C}$
5.1.7						15	mV
5.1.8	Dropout Voltage	V_{dr}		2		V	$I_{OUT} = 1\text{ A}$, $T_j = 25\text{ °C}$
5.1.9	Quiescent Current	I_q		3.5	5.0	mA	$I_{OUT} = 1\text{ A}$, $T_j = 25\text{ °C}$
5.1.10					3.5	6.0	mA
5.1.11	Quiescent Current Change	ΔI_q		1.0		mA	$5.0\text{ mA} \leq I_{OUT} \leq 1\text{ A}$
5.1.12				0.5	0.8	mA	$I_{OUT} = 1\text{ A}$ $7.5\text{ V} \leq V_{IN} \leq 20\text{ V}$ $T_j = 25\text{ °C}$
5.1.13				0.5	1.0	mA	$I_{OUT} = 0.5\text{ A}$ $8\text{ V} \leq V_{IN} \leq 25\text{ V}$
5.1.14	Output Noise Voltage	V_{Noise}		40		μV	$10\text{ Hz} \leq f \leq 100\text{ kHz}$, $T_j = 25\text{ °C}^{1)}$
5.1.15	Ripple Rejection	$PSRR$	68	75		dB	$f = 120\text{ Hz}$, $I_{OUT} = 10\text{ mA}$ $T_j = 25\text{ °C}^{2)}$
5.1.16	Short Circuit Current	I_{SC}	0.5	0.8	1.2	A	$V_{IN} = 35\text{ V}$, $T_j = 25\text{ °C}$
5.1.17	Peak Output Current	I_{PK}	2.0	2.4	2.9	A	$T_j = 25\text{ °C}$
5.1.18	Input Voltage Required to Maintain Line Regulation	$V_{IN,MIN}$	7.5			V	$T_j = 25\text{ °C}$

1) Not subject to production test

2) Not subject to production test

Note: The listed characteristics are ensured over the operating range of the integrated circuit. Typical characteristics specified mean values expected over the production spread. If not otherwise specified, typical characteristics apply at $T_A = 25\text{ °C}$ and the given supply voltage.

5.1.1 Typical Performance Graphs

Typical Performance Characteristics

Output Voltage V_{OUT} Vs Junction Temperature T_j ($V_{IN} = 7.5V$)

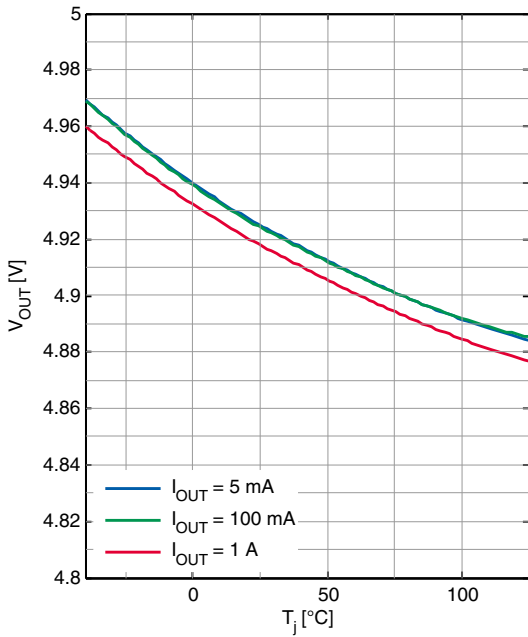

Output Voltage V_{OUT} Vs Junction Temperature T_j ($V_{IN} = 12V$)

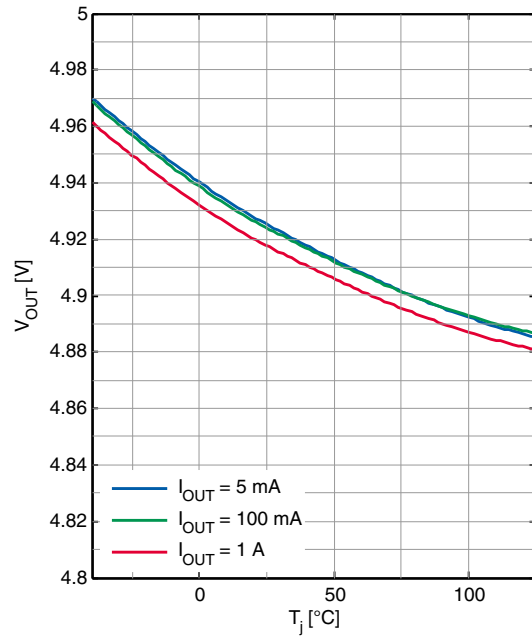

Output Voltage V_{OUT} Vs Junction Temperature T_j ($V_{IN} = 20V$)

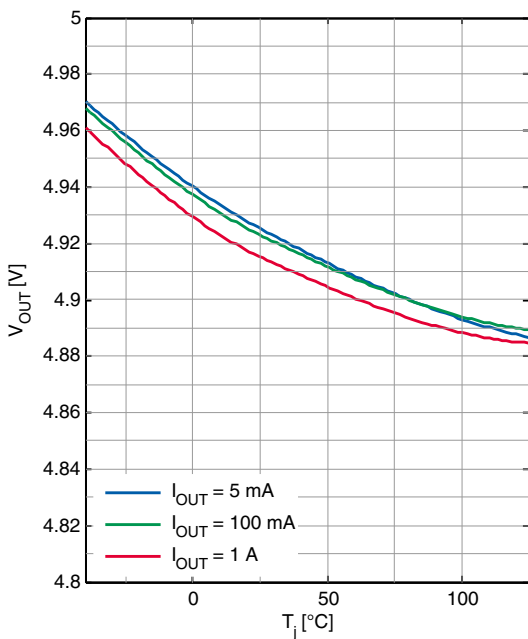

Drop Voltage V_{DR} Vs Junction Temperature T_j

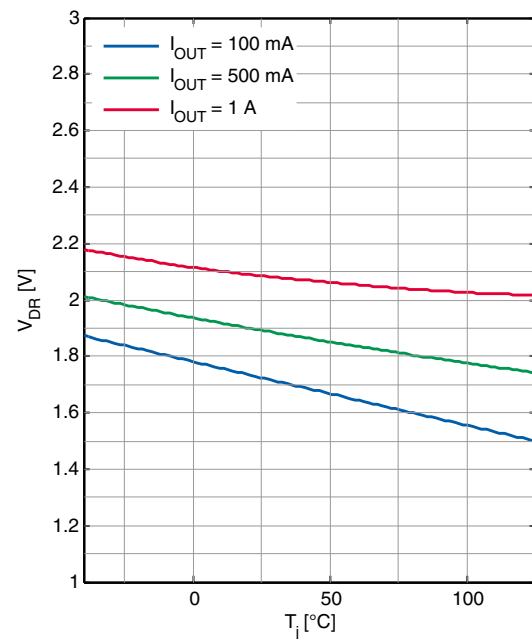

Drop Voltage V_{DR} Vs Output Current I_{OUT}

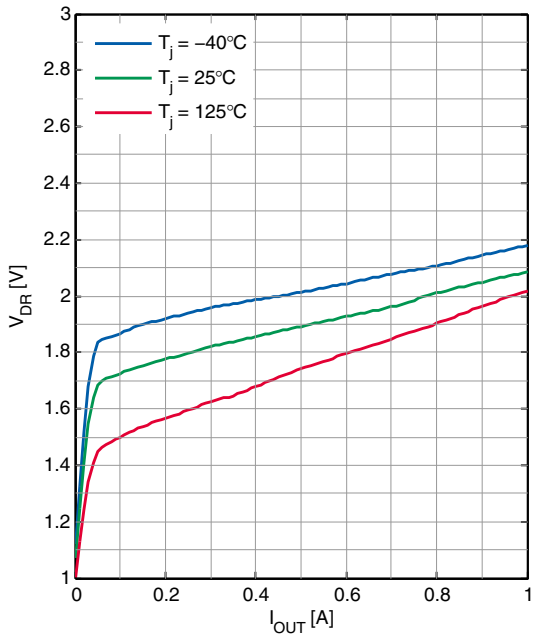

Current Limit Output Current I_{OUT} Vs Input Voltage V_{IN}

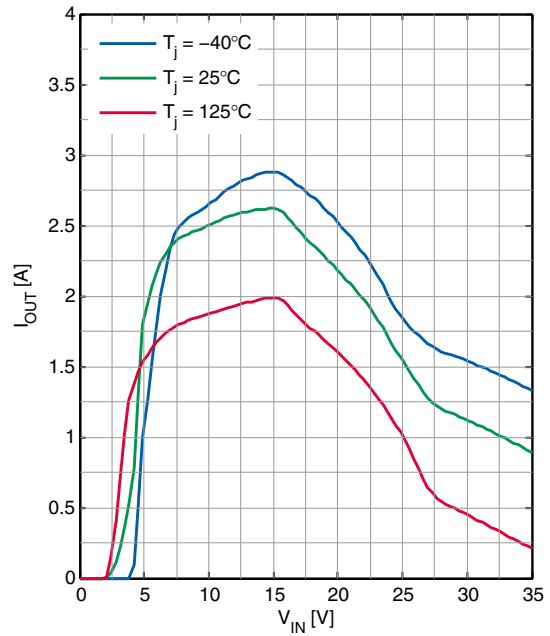

Line Regulation Output Current $I_{OUT} = 5\text{mA}$

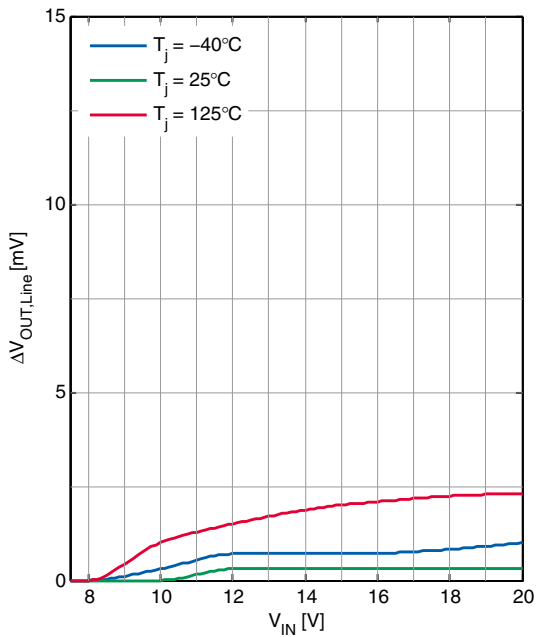

Line Regulation Output Current $I_{OUT} = 1\text{A}$

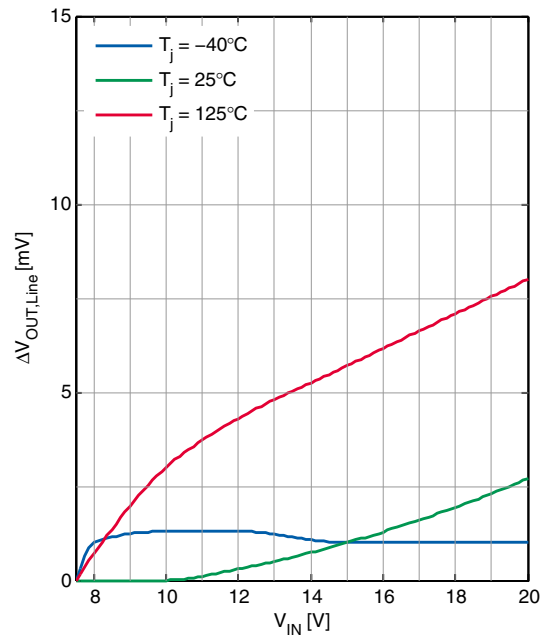

Load Regulation
Input Voltage $V_{IN} = 7.5V$

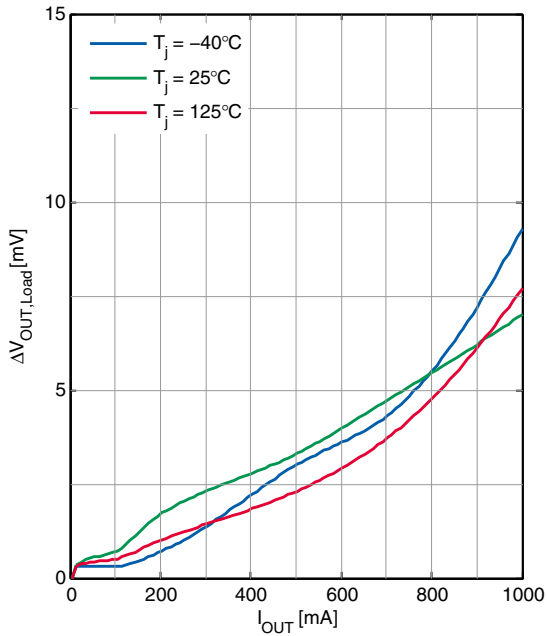

Load Regulation
Input Voltage $V_{IN} = 20V$

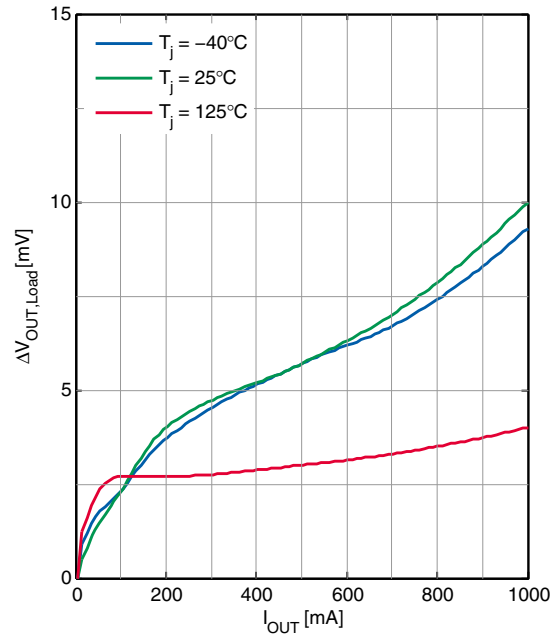

Current Consumption I_q Vs Output Current I_{OUT}

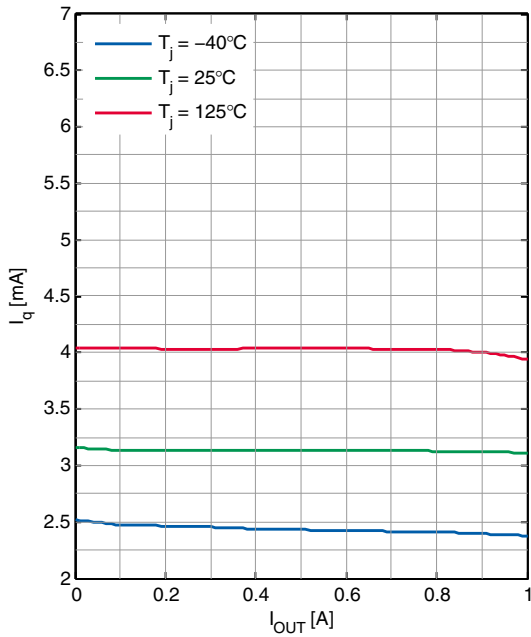

Current Consumption I_q Vs Input Voltage V_{IN}

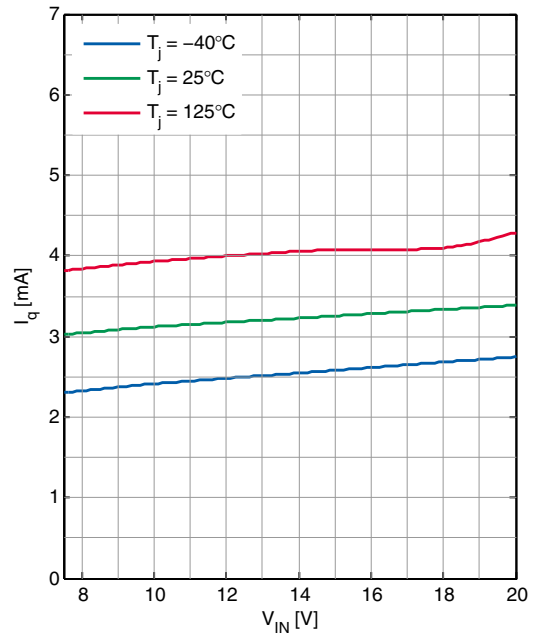

Power Supply Rejection Ratio
Output Current $I_{OUT} = 10 \text{ mA}$

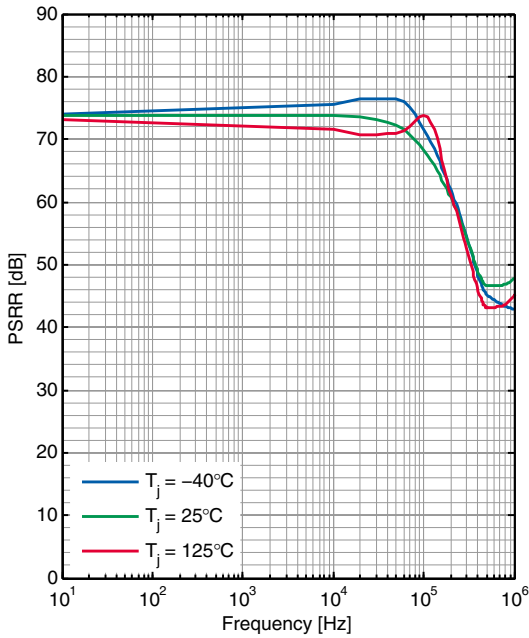

ESR Tunnel
ESR(C_{OUT}) Vs Output Current I_{OUT}

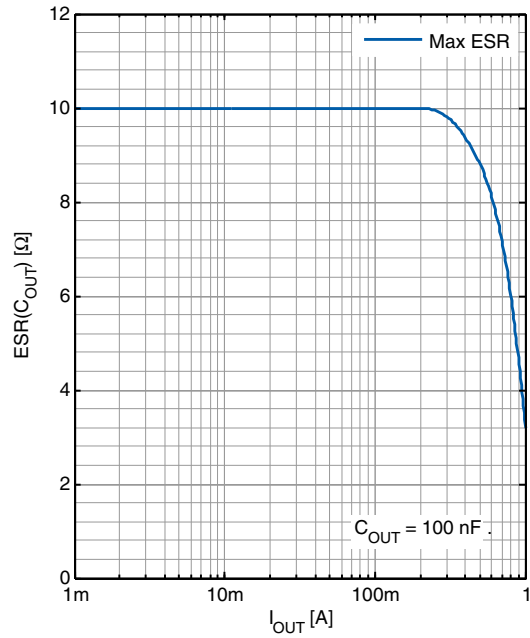

Line Transient Response

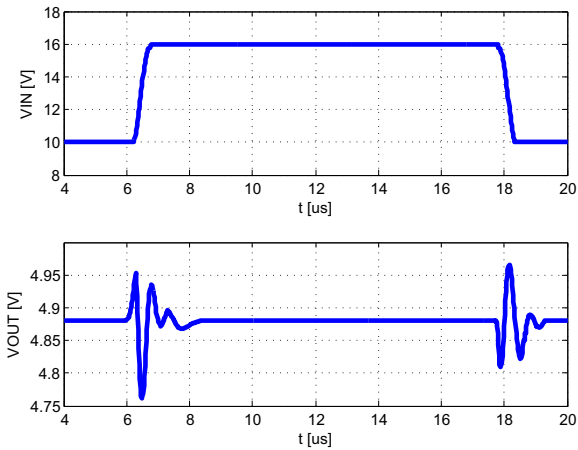

Load Transient Response

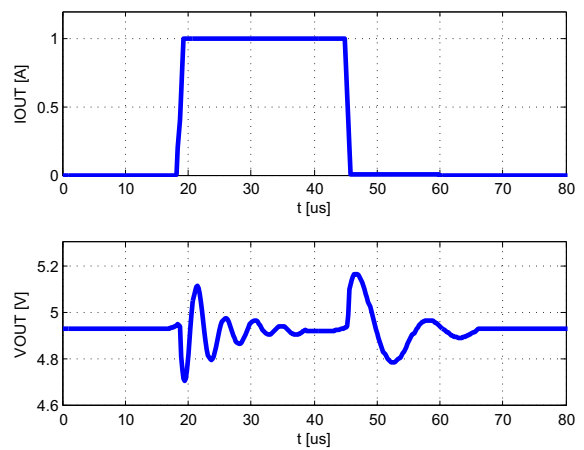

6 Application Information

Note: The following information is given as a hint for the implementation of the device only and shall not be regarded as a description or warranty of a certain functionality, condition or quality of the device.

6.1 Design Considerations

The IFX7805 linear voltage regulator has an in built thermal overload protection circuitry that shuts down the circuit when subjected to an excessive power overload condition. Thermal shutdown protects the regulator from immediate destruction due to high temperature conditions by turning it off. The thermal shutdown is set to a typical value of 175°C. Operating a linear regulator over the maximum junction temperature significantly reduces the life time of the device and pushes the operating variables outside their specified limits. The device also has an unbolts short circuit protection feature that keeps the output current within the specified bounds to protect both the regulator and the load. The safe-area compensation reduces the output short-circuit current as the voltage across the power stage is increased.

It is recommended that the regulator input is bypassed with a capacitor if the regulator is connected to the power supply filter with long lengths, or if the load capacitance at the output is large. A 0.33µF or larger tantalum or other capacitor, with a low internal impedance at high frequencies, should be chosen. The bypass capacitor should be mounted with the shortest possible leads directly across the input terminals of the regulator.

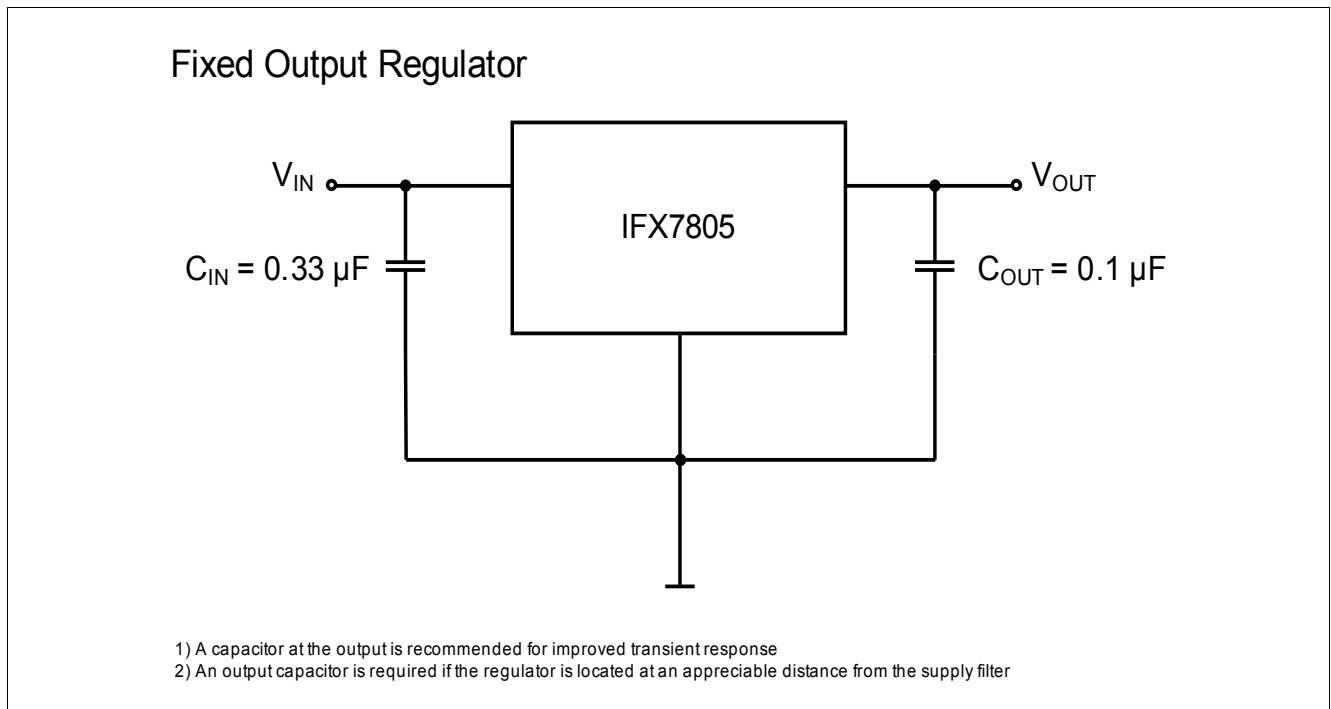

Figure 3 Typical Application Diagram

7 Package Outlines

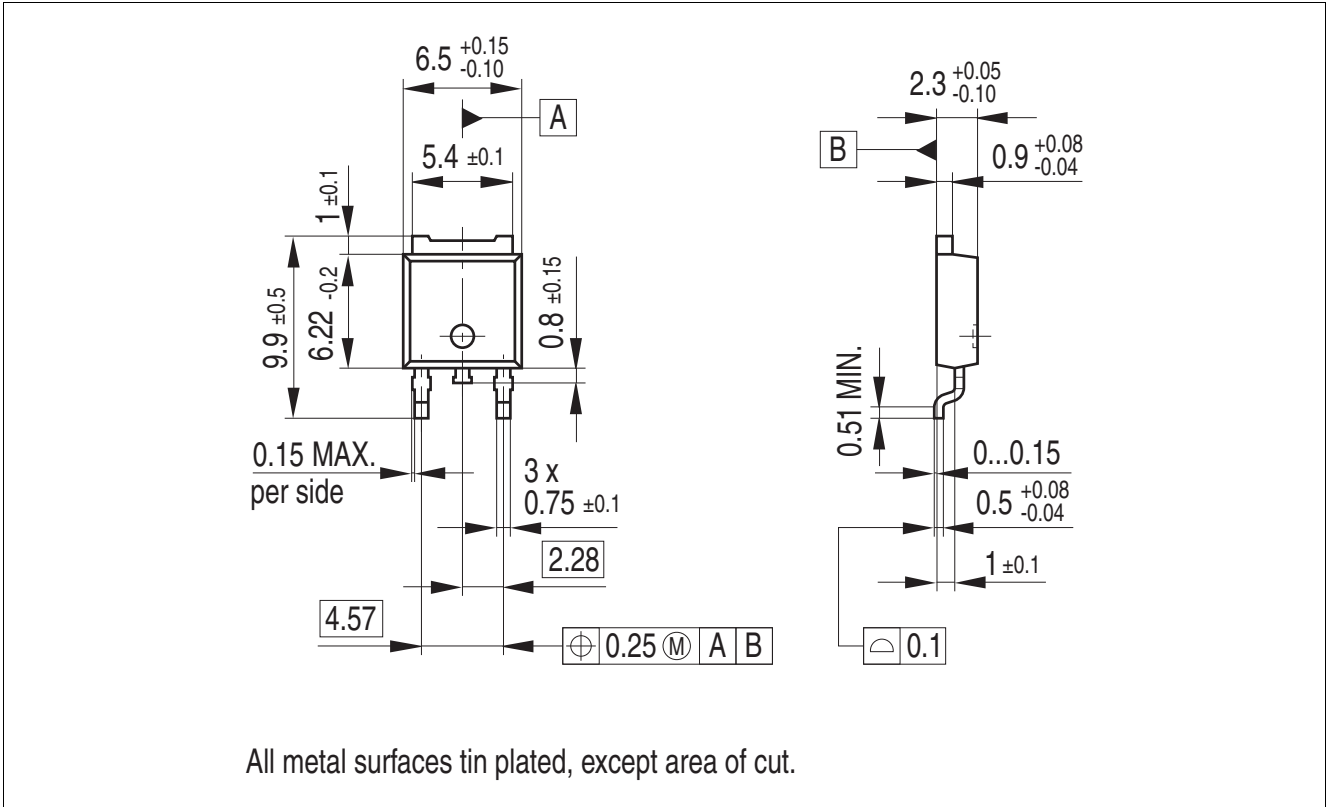

Figure 4 PG-TO-252-3 (Plastic Small Outline Transistor)

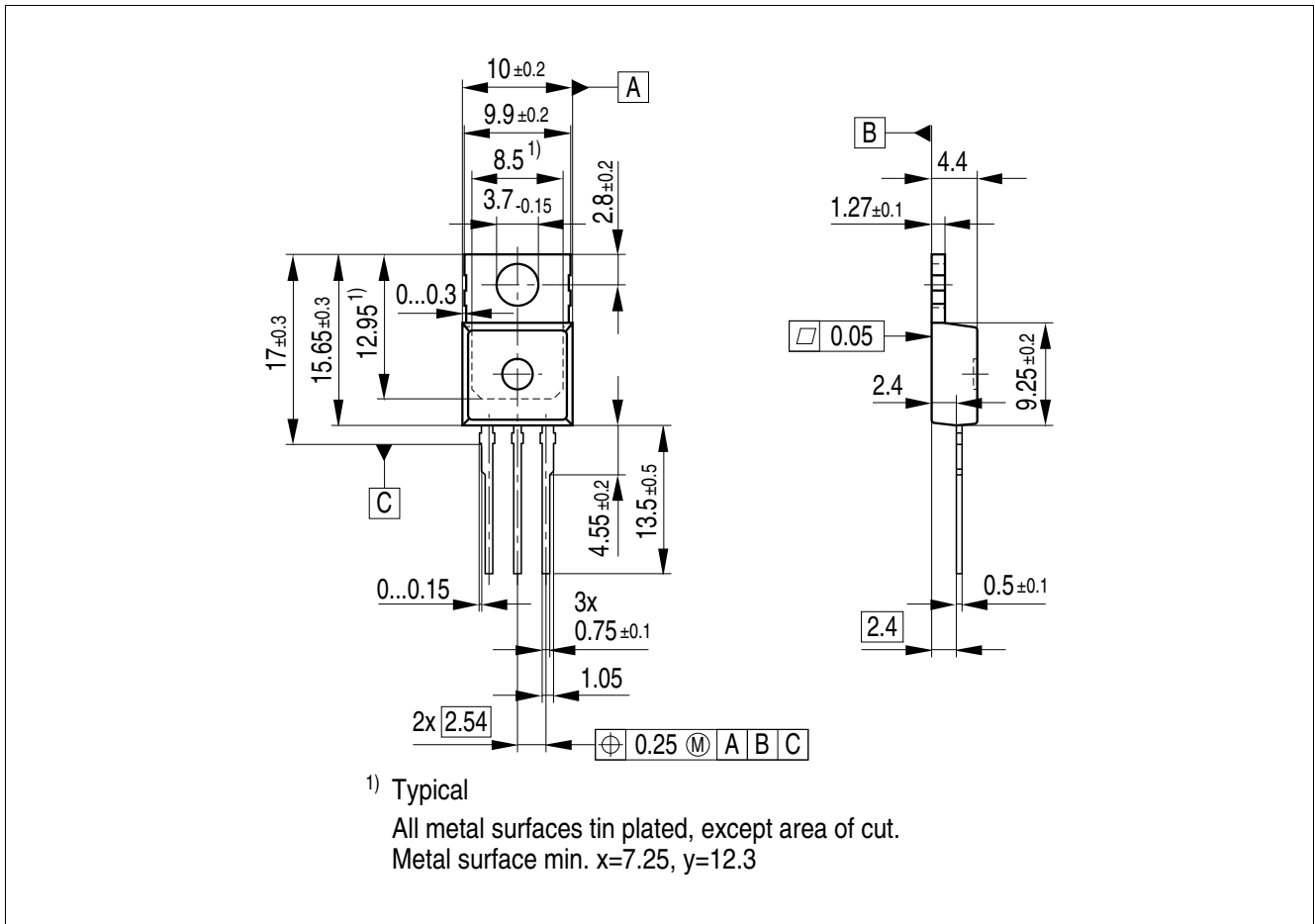

Figure 5 PG-TO-220-3 (Plastic Small Outline Transistor)

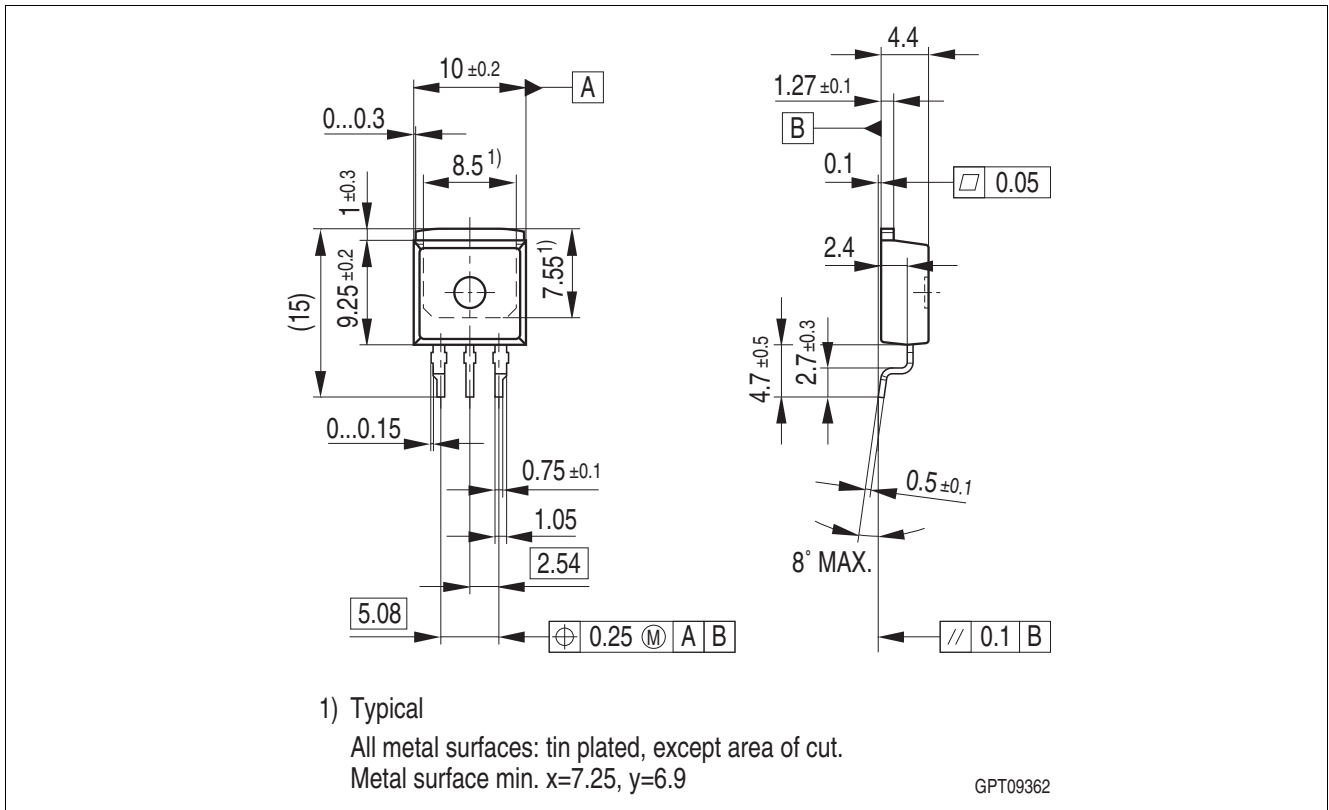

Figure 6 PG-TO-263-3 (Plastic Small Outline Transistor)

Green Product (RoHS compliant)

To meet the world-wide customer requirements for environmentally friendly products and to be compliant with government regulations the device is available as a green product. Green products are RoHS-Compliant (i.e Pb-free finish on leads and suitable for Pb-free soldering according to IPC/JEDEC J-STD-020).

8 Revision History

Revision	Date	Changes
1.0	2013-07-15	Datasheet - Initial Release

Edition 2013-07-15

**Published by
Infineon Technologies AG
81726 Munich, Germany**

**© 2011 Infineon Technologies AG
All Rights Reserved.**

Legal Disclaimer

The information given in this document shall in no event be regarded as a guarantee of conditions or characteristics. With respect to any examples or hints given herein, any typical values stated herein and/or any information regarding the application of the device, Infineon Technologies hereby disclaims any and all warranties and liabilities of any kind, including without limitation, warranties of non-infringement of intellectual property rights of any third party.

Information

For further information on technology, delivery terms and conditions and prices, please contact the nearest Infineon Technologies Office (www.infineon.com).

Warnings

Due to technical requirements, components may contain dangerous substances. For information on the types in question, please contact the nearest Infineon Technologies Office.

The Infineon Technologies component described in this Data Sheet may be used in life-support devices or systems and/or automotive, aviation and aerospace applications or systems only with the express written approval of Infineon Technologies, if a failure of such components can reasonably be expected to cause the failure of that life-support automotive, aviation and aerospace device or system or to affect the safety or effectiveness of that device or system. Life support devices or systems are intended to be implanted in the human body or to support and/or maintain and sustain and/or protect human life. If they fail, it is reasonable to assume that the health of the user or other persons may be endangered.