

2N4416
2N4416A

SILICON
N-CHANNEL JFETS



TO-72 CASE



www.centrasemi.com

DESCRIPTION:

The CENTRAL SEMICONDUCTOR 2N4416 and 2N4416A are silicon N-Channel Junction Field Effect Transistors designed for VHF amplifier and mixer applications.

MARKING: FULL PART NUMBER

MAXIMUM RATINGS: ($T_A=25^\circ\text{C}$)

Gate-Drain Voltage
Gate-Source Voltage
Drain-Source Voltage
Gate Current
Power Dissipation
Operating and Storage Junction Temperature

SYMBOL	2N4416	2N4416A	UNITS
V_{GD}	30	35	V
V_{GS}	30	35	V
V_{DS}	30	35	V
I_G		10	mA
P_D		300	mW
T_J, T_{stg}		-65 to +200	$^\circ\text{C}$

ELECTRICAL CHARACTERISTICS: ($T_A=25^\circ\text{C}$ unless otherwise noted)

SYMBOL	TEST CONDITIONS	2N4416		2N4416A		UNITS
		MIN	MAX	MIN	MAX	
I_{GSS}	$V_{GS}=20\text{V}, V_{DS}=0$	-	100	-	100	pA
I_{GSS}	$V_{GS}=20\text{V}, V_{DS}=0, T_A=150^\circ\text{C}$	-	100	-	100	nA
I_{DSS}	$V_{DS}=15\text{V}, V_{GS}=0$	5.0	15	5.0	15	mA
BV_{GSS}	$I_G=1.0\mu\text{A}$	30	-	35	-	V
$V_{GS(off)}$	$V_{DS}=15\text{V}, I_D=1.0\text{nA}$	-	6.0	2.5	6.0	V
g_{FS}	$V_{DS}=15\text{V}, V_{GS}=0, f=1.0\text{kHz}$	4,500	7,500	4,500	7,500	μS
g_{OS}	$V_{DS}=15\text{V}, V_{GS}=0, f=1.0\text{kHz}$	-	50	-	50	μS
C_{rss}	$V_{DS}=15\text{V}, V_{GS}=0, f=1.0\text{MHz}$	-	1.0	-	1.0	pF
C_{iss}	$V_{DS}=15\text{V}, V_{GS}=0, f=1.0\text{MHz}$	-	4.0	-	4.0	pF
C_{oss}	$V_{DS}=15\text{V}, V_{GS}=0, f=1.0\text{MHz}$	-	2.0	-	2.0	pF

HIGH FREQUENCY CHARACTERISTICS:

SYMBOL	TEST CONDITIONS	100MHz		400MHz		UNITS
		MIN	MAX	MIN	MAX	
g_{iss}	$V_{DS}=15\text{V}, V_{GS}=0$	-	100	-	1,000	μS
b_{iss}	$V_{DS}=15\text{V}, V_{GS}=0$	-	2,500	-	10,000	μS
g_{oss}	$V_{DS}=15\text{V}, V_{GS}=0$	-	75	-	100	μS
b_{oss}	$V_{DS}=15\text{V}, V_{GS}=0$	-	1,000	-	4,000	μS
g_{fs}	$V_{DS}=15\text{V}, V_{GS}=0$	-	-	4,000	-	μS
G_{ps}	$V_{DS}=15\text{V}, I_D=5.0\text{mA}$	18	-	10	-	dB
NF	$V_{DS}=15\text{V}, I_D=5.0\text{mA}, R_G=1.0\text{k}\Omega$	-	2.0	-	4.0	dB

R2 (4-June 2013)

2N4416
2N4416A

SILICON
N-CHANNEL JFETS



TO-72 CASE - MECHANICAL OUTLINE

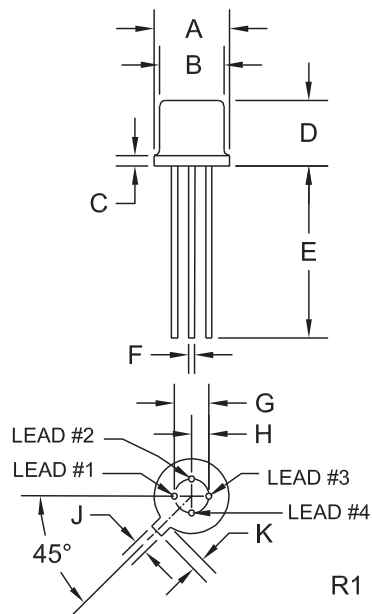

SYMBOL	INCHES		MILLIMETERS	
	MIN	MAX	MIN	MAX
A (DIA)	0.209	0.230	5.31	5.84
B (DIA)	0.175	0.195	4.45	4.95
C	-	0.030	-	0.76
D	0.170	0.210	4.32	5.33
E	0.500	-	12.70	-
F (DIA)	0.016	0.019	0.41	0.48
G (DIA)	0.100		2.54	
H	0.050		1.27	
J	0.036	0.046	0.91	1.17
K	0.028	0.048	0.71	1.22

TO-72 (REV: R1)

LEAD CODE:

- 1) Source
- 2) Drain
- 3) Gate
- 4) Case

MARKING:

FULL PART NUMBER

R2 (4-June 2013)

2N4416
2N4416A

SILICON
N-CHANNEL JFETS



www.centrasemi.com

TYPICAL ELECTRICAL CHARACTERISTICS

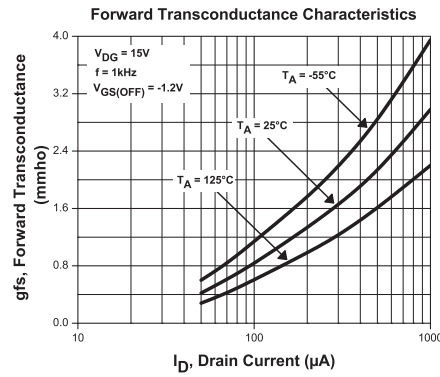
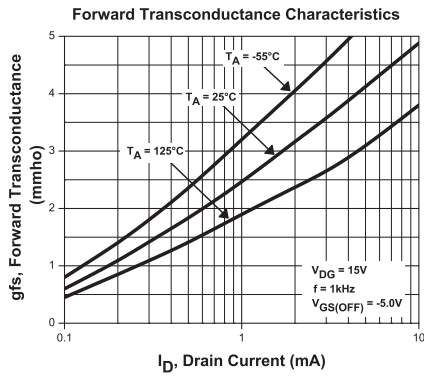
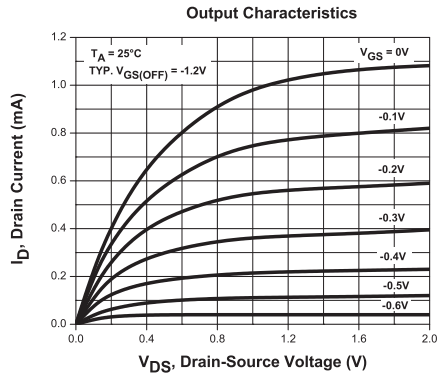
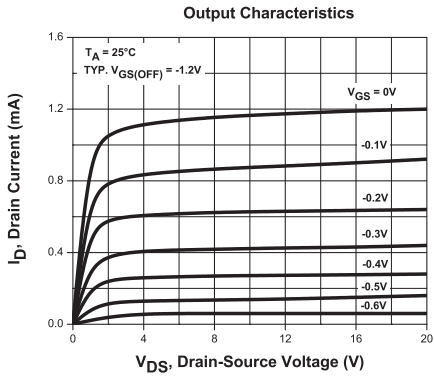
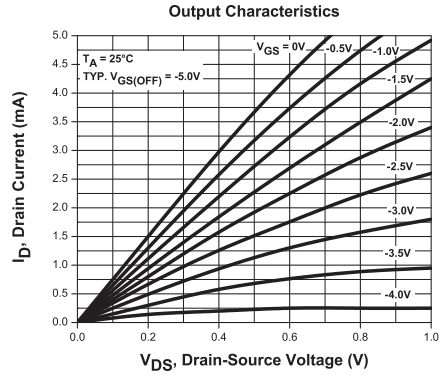
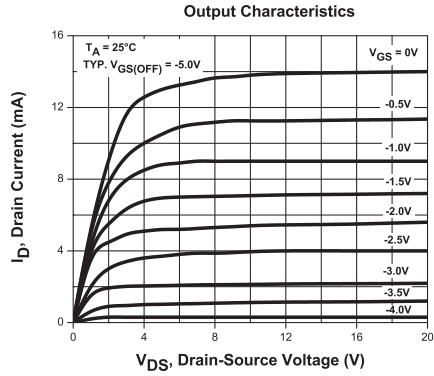

R2 (4-June 2013)

2N4416
2N4416A

SILICON
N-CHANNEL JFETS



TYPICAL ELECTRICAL CHARACTERISTICS

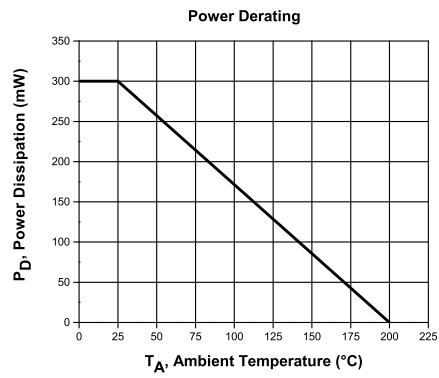
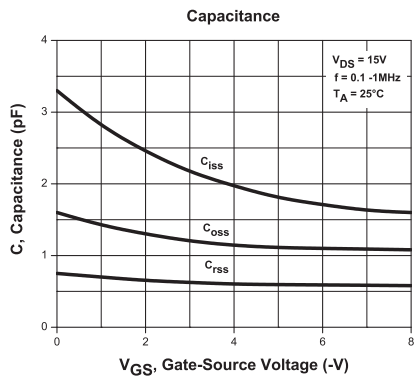
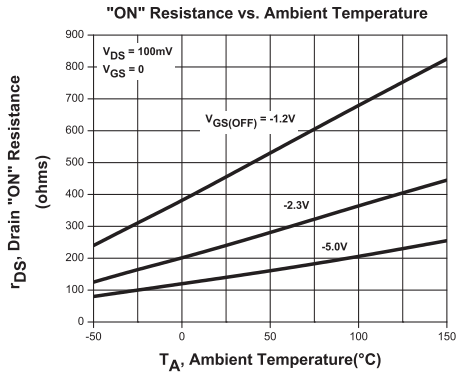
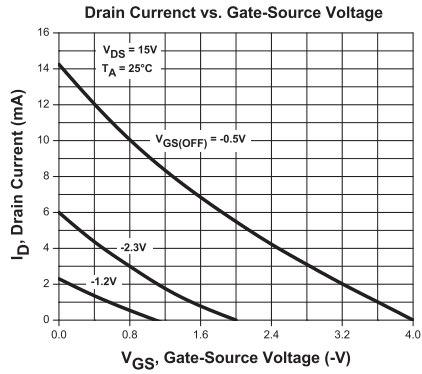

R2 (4-June 2013)

OUTSTANDING SUPPORT AND SUPERIOR SERVICES



PRODUCT SUPPORT

Central's operations team provides the highest level of support to insure product is delivered on-time.

- Supply management (Customer portals)
- Inventory bonding
- Consolidated shipping options
- Custom bar coding for shipments
- Custom product packing

DESIGNER SUPPORT/SERVICES

Central's applications engineering team is ready to discuss your design challenges. Just ask.

- Free quick ship samples (2nd day air)
- Online technical data and parametric search
- SPICE models
- Custom electrical curves
- Environmental regulation compliance
- Customer specific screening
- Up-screening capabilities
- Special wafer diffusions
- PbSn plating options
- Package details
- Application notes
- Application and design sample kits
- Custom product and package development

CONTACT US

Corporate Headquarters & Customer Support Team

Central Semiconductor Corp.
145 Adams Avenue
Hauppauge, NY 11788 USA
Main Tel: (631) 435-1110
Main Fax: (631) 435-1824
Support Team Fax: (631) 435-3388
www.centalsemi.com

Worldwide Field Representatives:
www.centalsemi.com/wwreps

Worldwide Distributors:
www.centalsemi.com/wwdistributors

For the latest version of Central Semiconductor's **LIMITATIONS AND DAMAGES DISCLAIMER**, which is part of Central's Standard Terms and Conditions of sale, visit: www.centalsemi.com/terms