

High Frequency Ceramic Solutions

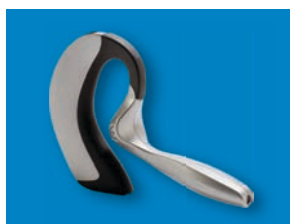
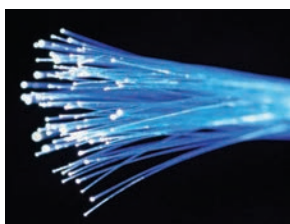

Antennas (88 MHz-10 GHz)

Baluns

Capacitors (Hi Q, Low Loss)

Chipset-Specific Impedance

Matched Balun-Filters

Couplers

Diplexers

Filters (Band-Pass, Low-Pass, etc)

Inductors (Wirewound & Monolithic)

IPC's (Integrated Passive Components)

Modules

90 Hybrids

Substrates

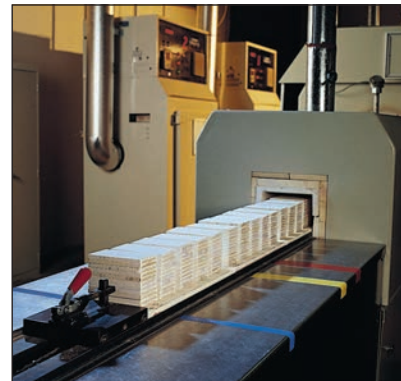
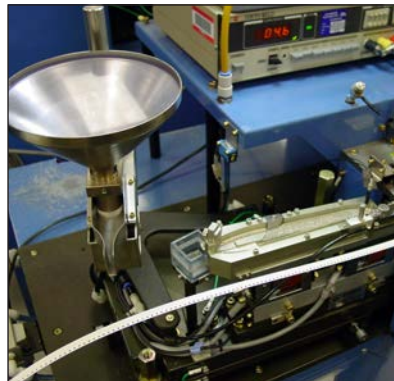
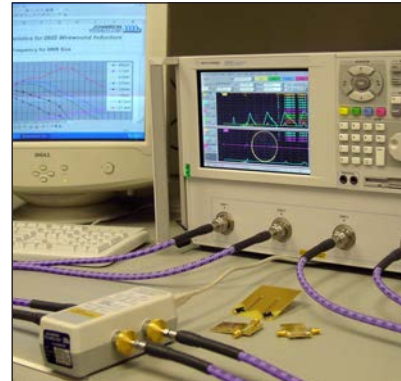

Your Technology Partner

The mission of the Johanson companies is to translate our customer needs into quality electronic components, produced in factories that are models of excellence, supported by innovative service. With over 20 years of experience, Johanson Technology can provide both standard and custom technology solutions tailored to your specific RF/Microwave applications. Our software design tools, library of more than 20 dielectric materials and various metal systems, and our thin-film and thick-film manufacturing capabilities enable us to produce components that are ideally suited to your specific needs.



Johanson Technology's ISO 9001 Certified design and manufacturing operations are located in Camarillo, California. Our quality minded management system utilizes the latest in computerized SPC systems and continuous improvement programs focused on increased product reliability, manufacturing through-put, and production yields. Our broad experience, applications support, software libraries, and responsive service enhance our ability to drive down your total cost of procurement and speed your time to market.

CONTENTS

Prototyping Kits	4-6
JTISoft® Capacitor & Inductor Modeling Software	6
Multi-Layer High-Q Capacitors	7-18
Monolithic Ceramic Chip Inductors	19-21
Wire Wound Ceramic Chip Inductors	22-27
Integrated Passive Component Overview	28
Antennas	29-30
Band Pass Filters	30-33
High Pass Filters	34
EMI Filters	34
Low Pass Filters	35-36
Directional Couplers	36-37
Baluns & Balun Filters	38-40
Diplexers	41-42
Integrated Passive Component Case Size Drawings	43-44
Custom LTCC Modules	45
LASERtrim® RF Tuning Capacitors	46-49
Broadband Single Layer Capacitors	50-51
Single Layer Microwave Capacitors	52-57
Custom Substrates & Thin Film Products	58-59
Chip Capacitor Packaging Information	60
Chip Inductor & Wirewound Inductor Packaging Information	61
Technical Notes List	62

Additional application notes may be found on our web site.

Johanson Technology, Inc. reserves the right to make design and price changes without notice. All sales are subject to the terms and conditions printed on the back side of our sales order acknowledgment forms including a limited warranty and remedies for non-conforming goods or defective goods. We will be pleased to provide a copy of these terms and conditions for your review.

RF Ceramic Component Proto-Typing Kits

Johanson Technology's engineering prototype kits provide RF designers with a broad selection of high frequency ceramic components. Each kit contains a selection of components as well as the latest product data on Johanson's full line of "High Frequency Ceramic Solutions". List price is \$100.00 each, but price may be waived for qualified high volume applications. *The selections listed below represents typical kit contents. Johanson reserves the right to make limited value/tolerance substitutions when necessary. Please advise any critical values at time of order.*



Capacitor and Inductor Design Kits

0201 L-Series Capacitors & Ceramic Inductors (Values {pF or nH} & tolerances) **P/N : L/C-201DL**
 50 PCS. EA. MLCC (pF): 0.3 B, 0.5 B, 0.7 B, 0.9 B, 1.0 B, 1.2 B, 1.5 B, 1.8 B, 2.2 B, 2.7 B, 3.0 B, 3.3 B, 3.6 B, 3.9 B, 4.3 B, 4.7 B, 5.1 C, 5.6 C, 6.8 C, 8.2 C, 9.1 C, 10 J, 12 J, 15 J, 18 J, 22 J, 27 J, 33 J

50 PCS. EA. MLCI (nH): 0.6 C, 0.8 C, 1.0 S, 1.2 S, 1.5 S, 1.8 S, 2.2 S, 2.4 S, 2.7 S, 3.0 S, 3.3 S, 3.7 S, 3.9 S, 4.7 S, 5.1 S, 5.6 S, 6.8 J, 8.2 J, 10 J, 12 J, 13 J, 15 J, 18 J, 20 J, 22 J, 27 J, 33 J, 39 J

0402 S-Series Capacitors & Ceramic Inductors (Values {pF or nH} & tolerances) **P/N : L/C-402DS**
 50 PCS. EA. MLCC (pF): 0.2 B, 0.3 B, 0.5 B, 0.7 B, 0.9 B, 1.0 B, 1.2 B, 1.5 B, 1.8 B, 2.0 B, 2.2 B, 2.4 B, 2.7 B, 3.0 B, 3.6 B, 4.3 B, 4.7 B, 5.6 C, 6.8 C, 7.5 C, 8.2 C, 9.1 C, 10 J, 12 J, 15 J, 22 J, 27 J, 30 J

50 PCS. EA. MLCI (nH): 1.0 S, 1.2 S, 1.5 S, 1.8 S, 2.2 S, 2.4 S, 2.7 S, 3.0 S, 3.3 S, 3.9 S, 4.3 S, 4.7 S, 5.1 S, 5.6 S, 6.8 J, 7.5 J, 8.2 J, 10 J, 12 J, 15 J, 18 J, 22 J, 27 J, 33 J, 39 J, 47 J, 68 J, 100 J

0603 S-Series Capacitors & Ceramic Inductors (Values {pF or nH} & tolerances) **P/N : L/C-603DS**
 50 PCS. EA. MLCC (pF): 0.3 B, 0.5 B, 0.8 B, 1.0 B, 1.2 B, 1.5 B, 1.8 B, 2.2 B, 2.7 B, 3.3 B, 3.6 B, 3.9 B, 4.7 B, 5.6 C, 6.8 C, 8.2 C, 10 J, 12 J, 15 J, 18 J, 20 J, 24 J, 27 J, 33 J, 39 J, 47 J, 68 J, 82 J

50 PCS. EA. MLCI (nH): 1.0 S, 1.5 S, 1.8 S, 2.2 S, 2.7 S, 3.3 S, 3.9 S, 4.7 S, 5.6 S, 6.8 J, 8.2 J, 10 J, 12 J, 15 J, 18 J, 22 J, 27 J, 33 J, 39 J, 47 J, 56 J, 68 J, 82 J, 100 J, 120 J, 150 J, 180 J, 220 J

0805 S-Series Capacitors & WireWound High Q Chip Inductors (Values {pF or nH} & tolerances) **P/N : L/C-805DS**
 50 PCS. EA. MLCC (pF): 4.7 B, 5.6 C, 6.8 C, 7.5 C, 8.2 C, 9.1 C, 10 J, 12 J, 15 J, 18 J, 20 J, 22 J, 24 J, 27 J, 30 J, 33 J, 36 J, 39 J, 43 J, 47 J, 56 J, 68 J, 82 J, 100 J, 120 J, 150 J, 180 J, 220 J

20 PCS. EA. (nH): 2.7 C, 3.9 C, 5.6 C, 6.8 J, 8.2 J, 12 J, 16 J, 20 J, 27 J, 33 J, 39 J, 47 J, 56 J, 68 J, 82 J, 100 J, 120 J, 150 J, 180 J, 220 J, 270 J, 330 J, 390 J, 560 J, 1000 J, 2200 J, 6800 J, 10000 J

Non-Magnetic Capacitor Designer Kit

EIA 1111 S42E-Series Capacitors (Values {pF} & tolerances) Non-Magnetic **P/N: S111DUE**
 10 PCS. EACH (pF): 1.0 B, 3.9 B, 4.7 B, 6.8 C, 7.5 C, 8.2 C, 9.1 C, 10 J, 12 J, 15 J, 18 J, 20 J, 27 J, 33 J, 47 J, 56 J, 68 J, 82 J, 100 J, 120 J, 150 J, 180 J, 220 J, 270 J, 390 J, 470 J, 560 K, 1000 K

Tuning Capacitor Kits

0201 L-Series Capacitors (Values {pF} & tolerances) **P/N: S201TL**
 50 PCS. EACH (pF): 0.2 A, 0.3 A, 0.4 A, 0.5 B, 0.6 B, 0.7 B, 0.8 B, 0.9 B, 1.0 B, 1.1 B, 1.2 B, 1.3 B, 1.5 B, 1.8 B, 2.0 B, 2.2 B, 2.4 B, 2.7 B, 3.0 B, 3.3 B, 3.6 B, 3.9 B, 4.3 B, 4.7 B, 5.1 C, 5.6 C, 6.2 C, 6.8 C

0201 L-Series Ultra High-Q Capacitors (Values {pF} & tolerances) **P/N: S201DS**
 50 PCS. EACH (pF): 0.3 B, 0.5 B, 0.7 B, 0.9 B, 1.0 B, 1.2 B, 1.3 B, 1.5 B, 1.6 B, 1.8 B, 2.0 B, 2.2 B, 2.4 B, 2.7 B, 3.0 B, 3.3 B, 3.6 B, 3.9 B, 4.3 B, 4.7 B, 5.1 C, 5.6 C, 6.8 C, 8.2 C, 9.1 C, 10 J, 12 J, 15 J

0402 S-Series Capacitors (Values {pF} & tolerances) **P/N: S402TS**
 50 PCS. EACH (pF): 0.2 A, 0.3 A, 0.4 A, 0.5 B, 0.6 B, 0.7 B, 0.8 B, 0.9 B, 1.0 B, 1.1 B, 1.2 B, 1.3 B, 1.5 B, 1.8 B, 2.0 B, 2.2 B, 2.4 B, 2.7 B, 3.0 B, 3.3 B, 3.6 B, 3.9 B, 4.3 B, 4.7 B, 5.1 C, 5.6 C, 6.2 C, 6.8 C

0603 S-Series Capacitors (Values {pF} & tolerances) **P/N: S603TS**
 50 PCS. EACH (pF): 0.2 B, 0.3 B, 0.4 B, 0.5 B, 0.6 B, 0.7 B, 0.8 B, 0.9 B, 1.0 B, 1.1 B, 1.2 B, 1.3 B, 1.5 B, 1.8 B, 2.0 B, 2.2 B, 2.4 B, 2.7 B, 3.0 B, 3.3 B, 3.6 B, 3.9 B, 4.3 B, 4.7 B, 5.1 C, 5.6 C, 6.2 C, 6.8 C

0805 S-Series Capacitors (Values {pF} & tolerances) **P/N: S805TS**
 50 PCS. EACH (pF): 0.3 B, 0.5 B, 0.7 B, 0.9 B, 1.0 B, 1.1 B, 1.2 B, 1.3 B, 1.5 B, 1.8 B, 2.0 B, 2.2 B, 2.4 B, 2.7 B, 3.0 B, 3.3 B, 3.6 B, 3.9 B, 4.3 B, 4.7 B, 5.1 C, 5.6 C, 6.2 C, 6.8 C, 7.5 C, 8.2 C, 9.1 C, 10 J

1111 E-Series Capacitors (Values {pF} & tolerances) **P/N: S111TVE**
 10 PCS. EACH (pF): 0.5 B, 0.6 B, 0.7 B, 0.8 B, 0.9 B, 1.0 B, 1.1 B, 1.2 B, 1.3 B, 1.5 B, 2.0 B, 2.2 B, 2.4 B, 2.7 B, 3.0 B, 3.3 B, 3.6 B, 3.9 B, 4.3 B, 4.7 B, 5.1 C, 5.6 C, 6.2 C, 6.8 C, 7.5 C, 8.2 C, 9.1 C, 10 J

Non-Magnetic Capacitor Tuning Kit

EIA 1111 S42E-Series Capacitors (Values {pF} & tolerances) Non-Magnetic **P/N: S111TUE**
 10 PCS. EACH (pF): 0.5 B, 0.6 B, 0.7 B, 0.8 B, 0.9 B, 1.0 B, 1.1 B, 1.2 B, 1.3 B, 1.5 B, 2.0 B, 2.2 B, 2.4 B, 2.7 B, 3.0 B, 3.3 B, 3.6 B, 3.9 B, 4.3 B, 4.7 B, 5.1 C, 5.6 C, 6.2 C, 6.8 C, 7.5 C, 8.2 C, 9.1 C, 10 J

Single Layer Capacitor Kits

Broadband Single Layer Capacitors **P/N: GBBL**
 10 PCS. EACH: 500U01A470MT4W, 500U01A800MT4W, 500U01A101MT4W, 160U01A331MT4W, 160U01A471MT4W, 250U02A471MT4W, 250U02A471MT4W-10, 160U02A102MT4W, 500U03A561MT4W-10, 160U03A222MN4W

Standard Single Layer Capacitors

Broadband Single Layer Capacitors

P/N: SLC

10 PCS. EACH: 500U10N0R4BT4W, 101V10L1R5MT4W, 500U10B5R1KT4W, 500V15W100KN4W, 101U15T500MT4W, 101U20X390MT4W, 500U20T101KT4W, 500U25N2R0CN4W, 101V25T101MN4W, 101V30Y471MT4W

WireWound Inductor Kits

0402 WireWound High Q Chip Inductors (Values {nH} & tolerances)

P/N: L402W

20 PCS. EACH (nH): 1.0 C, 1.8 C, 2.0 C, 2.7 C, 3.3 C, 3.9 C, 4.7 C, 5.6 C, 6.8 J, 7.5 J, 8.2 J, 9.0 J, 10 J, 12 J, 15 J, 18 J, 20 J, 22 J, 24 J, 27 J, 30 J, 33 J, 39 J, 47 J, 56 J, 82 J, 100 J, 120 J

0603 WireWound High Q Chip Inductors (Values {nH} & tolerances)

P/N: L603W

20 PCS. EACH (nH): 1.6 C, 1.8 C, 2.0 C, 3.9 C, 4.7 C, 5.1 C, 5.6 C, 6.8 J, 7.5 J, 8.2 J, 10 J, 12 J, 15 J, 18 J, 22 J, 27 J, 33 J, 39 J, 47 J, 56 J, 68 J, 72 J, 82 J, 100 J, 150 J, 180 J, 270 J, 330 J

0805 WireWound High Q Chip Inductors (Values {nH} & tolerances)

P/N: L805W

20 PCS. EACH (nH): 2.7 C, 3.9 C, 5.6 C, 6.8 J, 8.2 J, 12 J, 16 J, 20 J, 27 J, 33 J, 39 J, 47 J, 56 J, 68 J, 82 J, 100 J, 120 J, 150 J, 180 J, 220 J, 270 J, 330 J, 390 J, 560 J, 1000 J, 2200 J, 6800 J, 10000 J

(Individual) Capacitor, Inductor Designer Kits

0201 L-Series Capacitors (Values {pF} & tolerances)

P/N: S201DL

50 PCS. EACH (pF): 0.3 B, 0.5 B, 0.7 B, 0.9 B, 1.0 B, 1.2 B, 1.5 B, 1.8 B, 2.2 B, 2.7 B, 3.0 B, 3.3 B, 3.6 B, 3.9 B, 4.3 B, 4.7 B, 5.1 C, 5.6 C, 6.8 C, 8.2 C, 9.1 C, 10 J, 12 J, 15 J, 18 J, 22 J, 27 J, 33 J

0201 L-Series Ultra High-Q Capacitors Horizontal Electrode Orientation (Values {pF} & tolerances)

P/N: S201DS

Contains 50 PCS. EACH of the following 0201 capacitor sizes

(pF): 0.3 B, 0.5 B, 0.7 B, 0.9 B, 1.0 B, 1.2 B, 1.5 B, 1.8 B, 2.2 B, 2.7 B, 3.0 B, 3.3 B, 3.6 B, 3.9 B, 4.3 B, 4.7 B, 5.1 C, 5.6 C, 6.8 C, 8.2 C, 9.1 C, 10 J, 12 J, 15 J

0201 Inductors (Values {nH} & tolerances)

P/N: L201DC

50 PCS. EACH (nH): 0.6 C, 0.8 C, 1.0 S, 1.2 S, 1.5 S, 1.8 S, 2.2 S, 2.4 S, 2.7 S, 3.0 S, 3.3 S, 3.7 S, 3.9 S, 4.7 S, 5.1 S, 5.6 S, 6.8 J, 8.2 J, 10 J, 12 J, 13 J, 15 J, 18 J, 20 J, 22 J, 27 J, 33 J, 39 J

0402 S-Series Capacitors (Values {pF} & tolerances)

P/N: S402DS

50 PCS. EACH (pF): 0.2 B, 0.3 B, 0.5 B, 0.7 B, 0.9 B, 1.0 B, 1.2 B, 1.5 B, 1.8 B, 2.0 B, 2.2 B, 2.4 B, 2.7 B, 3.0 B, 3.6 B, 4.3 B, 4.7 B, 5.6 C, 6.8 C, 7.5 C, 8.2 C, 9.1 C, 10 J, 12 J, 15 J, 22 J, 27 J, 30 J

0402 Inductors (Values {nH} & tolerances)

P/N: L402DC

50 PCS. EACH (nH): 1.0 S, 1.2 S, 1.5 S, 1.8 S, 2.2 S, 2.4 S, 2.7 S, 3.0 S, 3.3 S, 3.9 S, 4.3 S, 4.7 S, 5.1 S, 5.6 S, 6.8 J, 7.5 J, 8.2 J, 10 J, 12 J, 15 J, 18 J, 22 J, 27 J, 33 J, 39 J, 47 J, 68 J, 100 J

0603 S-Series Capacitors (Values {pF} & tolerances)

P/N: S603DS

50 PCS. EACH (pF): 0.3 B, 0.5 B, 0.8 B, 1.0 B, 1.2 B, 1.5 B, 1.8 B, 2.2 B, 2.7 B, 3.3 B, 3.6 B, 3.9 B, 4.7 B, 5.6 C, 6.8 C, 8.2 C, 10 J, 12 J, 15 J, 18 J, 20 J, 24 J, 27 J, 33 J, 39 J, 47 J, 68 J, 82 J

0603 Inductors (Values {nH} & tolerances)

P/N: L603DC

50 PCS. EACH (nH): 1.0 S, 1.5 S, 1.8 S, 2.2 S, 2.7 S, 3.3 S, 3.9 S, 4.7 S, 5.6 S, 6.8 J, 8.2 J, 10 J, 12 J, 15 J, 18 J, 22 J, 27 J, 33 J, 39 J, 47 J, 56 J, 68 J, 82 J, 100 J, 120 J, 150 J, 180 J, 220 J

0805 S-Series Capacitors (Values {pF} & tolerances)

P/N: S805DS

50 PCS. EACH (pF): 4.7 B, 5.6 C, 6.8 C, 7.5 C, 8.2 C, 9.1 C, 10 J, 12 J, 15 J, 18 J, 20 J, 22 J, 24 J, 27 J, 30 J, 33 J, 36 J, 39 J, 43 J, 47 J, 56 J, 68 J, 82 J, 100 J, 120 J, 150 J, 180 J, 220 J

1111 E-Series Capacitors (Values {pF} & tolerances)

P/N: S111DVE

10 PCS. EACH (pF): 1.0 B, 3.9 B, 4.7 B, 6.8 C, 7.5 C, 8.2 C, 9.1 C, 10 J, 12 J, 15 J, 18 J, 20 J, 27 J, 33 J, 47 J, 56 J, 68 J, 82 J, 100 K, 120 K, 150 K, 180 K, 220 K, 270 K, 390 K, 470 K, 560 K, 1000 K

2.45GHz Designer Kit for WLAN, Bluetooth, Zigbee, ISM and 802.11

0402 S-Series Capacitors, 0402 Inductors & 2.45 GHz RF Components

P/N: 2450L/C402D

6 PCS. EA. BAND PASS FILTERS: 2450BP07A100, 2450BP15B100

6 PCS. EA. CHIP ANTENNA: 2450AT18A100, 2450AT18B100, 2450AT42A100, 2450AT42B100, 2450AT43A100, 2450AT43B100, 2450AT45A100

6 PCS. EA. LOW PASS FILTER: 2450LP14A100, 2450LP14B100, 2450LP15A050 6 PCS. EA. HIGH PASS FILTER: 2450HP14A100

6 PCS. EA. BALUN: 2450BL14C050, 2450BL14C100, 2450BL15B050, 2450BL15B100, 2450BL15B200

6 PCS. EA. FILTER BALUN: 2450FB15A050, 2450FB39A050 6 PCS. EA. DIPLEXER: 2450DP15A5512, 2450DP15D5400

50 PCS. EA. MLCC (pF): 0.3 B, 0.5 B, 1.0 B, 1.5 B, 1.8 B, 2.2 B, 2.7 B, 3.3 B, 3.9 B, 4.7 B, 5.6 C, 6.8 C, 8.2 C, 10 J

50 PCS. EA. MLCI (nH): 1.0 S, 1.5 S, 1.8 S, 2.2 S, 2.7 S, 3.3 S, 4.7 S, 5.6 S, 6.8 J, 8.2 J, 10 J, 15 J, 18 J, 27 J

0603 S-Series Capacitors, 0603 Inductors & 2.45 GHz RF Components

P/N: 2450L/C603D

6 PCS. EA. BAND PASS FILTERS: 2450BP07A100, 2450BP15B100

6 PCS. EA. CHIP ANTENNA: 2450AT18A100, 2450AT18B100, 2450AT42A100, 2450AT42B100, 2450AT43A100, 2450AT43B100, 2450AT45A100

6 PCS. EA. LOW PASS FILTER: 2450LP14A100, 2450LP14B100, 2450LP15A050 6 PCS. EA. HIGH PASS FILTER: 2450HP14A100

6 PCS. EA. BALUN: 2450BL14C050, 2450BL14C100, 2450BL15B050, 2450BL15B100, 2450BL15B200

6 PCS. EA. FILTER BALUN: 2450FB15A050, 2450FB39A050 6 PCS. EA. DIPLEXER: 2450DP15A5512, 2450DP15D5400

50 PCS. EA. MLCC (pF): 0.3 B, 0.5 B, 1.0 B, 1.5 B, 1.8 B, 2.2 B, 2.7 B, 3.3 B, 3.9 B, 4.7 C, 5.6 C, 6.8 C, 8.2 C, 10 J

50 P CS. EA. MLCI (nH): 1.0 S, 1.5 S, 1.8 S, 2.2 S, 2.7 S, 3.3 S, 4.7 S, 5.6 S, 6.8 J, 8.2 J, 10 J, 15 J, 18 J, 27 J



5.5GHz Designer Kit for WLAN, Bluetooth, ISM and 802.11

0402 S-Series Capacitors, 0402 Inductors & RF Components

P/N: 5500L/C402D

6 PCS. EA. BAND PASS FILTERS: 5515BP15C1020, 5515BP15B725, 5515BP15B730, 5515BP15C975, 5487BP15B675, 5487BP15C675
 6 PCS. EA. CHIP ANTENNA: 2450AD46A5400, 5250AT43A200, 5400AT18A1000, 5500AT07A0900 6 PCS. EA. LOW PASS FILTER 5515LP15A730
 6 PCS. EA. BALUN: 5400BL15B050, 5400BL15B100, 5400BL15K050, 5400BL14B100, 5800BL15B100
 6 PCS. EA. DIPLEXER: 2450DP15A5512, 2450DP15K5400, 2450DP15D5400, 2450DP15E5400
 50 PCS. EA. MLCC (pF): 0.3 B, 0.5 B, 0.8 B, 1.0 B, 1.2 B, 1.5 B, 1.8 B, 2.0 B, 2.2 B, 2.7 B, 3.3 B, 3.9 B, 4.7 B, 5.6 C
 50 PCS. EA. MLCI (nH): 1.0 S, 1.5 S, 1.8 S, 2.2 S, 2.7 S, 3.3 S, 3.9 S, 4.7 S, 5.6 S, 6.8 J, 8.2 J, 10 J, 12 J, 15 J

0603 S-Series Capacitors, 0603 Inductors & RF Components

P/N: 5500L/C603D

6 PCS. EA. BAND PASS FILTERS: 5515BP15C1020, 5515BP15B725, 5515BP15B730, 5515BP15C975, 5487BP15B675, 5487BP15C675
 6 PCS. EA. CHIP ANTENNA: 2450AD46A5400, 5250AT43A200, 5400AT18A1000, 5500AT07A0900 6 PCS. EA. LOW PASS FILTER 5515LP15A730
 6 PCS. EA. BALUN: 5400BL15B050, 5400BL15B100, 5400BL15K050, 5400BL14B100, 5800BL15B100
 6 PCS. EA. DIPLEXER: 2450DP15A5512, 2450DP15K5400, 2450DP15D5400, 2450DP15E5400
 50 PCS. EA. MLCC (pF): 0.3 B, 0.5 B, 0.8 B, 1.0 B, 1.2 B, 1.5 B, 1.8 B, 2.0 B, 2.2 B, 2.7 B, 3.3 B, 3.9 B, 4.7 B, 5.6 C
 50 PCS. EA. MLCI (nH): 1.0 S, 1.5 S, 1.8 S, 2.2 S, 2.7 S, 3.3 S, 3.9 S, 4.7 S, 5.6 S, 6.8 J, 8.2 J, 10 J, 12 J, 15 J

Designer Kit for WiMAX & UWB

0402 S-Series Capacitors, 0402 Inductors & RF Components

P/N: WUWBL/C402D

6 PCS. EA. CHIP ANTENNA: 2500AT44M0400, 3100AT51A7200 6 PCS. EA. LOW PASS FILTER 3550LP14A300
 6 PCS. EA. BAND PASS FILTERS: 2500BP15M400, 3600BP15M600, 4000BP15U1800, 5130BP18U4060
 6 PCS. EA. BALUN: 2500BL14M050, 2450BL14M100, 3600BL14M050, 3600BL14M100, 4000BL14U100
 6 PCS. EA. FILTER BALUN: 2345FB39A0050, 2595FB39A0050, 3500FB39A0050
 50 PCS. EA. MLCC (pF): 0.3 B, 0.5 B, 1.0 B, 1.5 B, 1.8 B, 2.2 B, 2.7 B, 3.3 B, 3.9 B, 4.7 B, 5.6 C, 6.8 C, 8.2 C, 10 J
 50 PCS. EA. MLCI (nH): 1.0 S, 1.5 S, 1.8 S, 2.2 S, 2.7 S, 3.3 S, 4.7 S, 5.6 S, 6.8 J, 8.2 J, 10 J, 15 J, 18 J, 27 J

0603 S-Series Capacitors, 0603 Inductors & RF Components

P/N: WUWBL/C603D

6 PCS. EA. CHIP ANTENNA: 2500AT44M0400, 3100AT51A7200 6 PCS. EA. LOW PASS FILTER 3550LP14A300
 6 PCS. EA. BAND PASS FILTERS: 2500BP15M400, 3600BP15M600, 4000BP15U1800, 5130BP18U4060
 6 PCS. EA. BALUN: 2500BL14M050, 2450BL14M100, 3600BL14M050, 3600BL14M100, 4000BL14U100
 6 PCS. EA. FILTER BALUN: 2345FB39A0050, 2595FB39A0050, 3500FB39A0050
 50 PCS. EA. MLCC (pF): 0.3 B, 0.5 B, 1.0 B, 1.5 B, 1.8 B, 2.2 B, 2.7 B, 3.3 B, 3.9 B, 4.7 B, 5.6 C, 6.8 C, 8.2 C, 10 J
 50 PCS. EA. MLCI (nH): 1.0 S, 1.5 S, 1.8 S, 2.2 S, 2.7 S, 3.3 S, 4.7 S, 5.6 S, 6.8 J, 8.2 J, 10 J, 15 J, 18 J, 27 J

Standard Termination for all kits - 100% Sn. Consult Factory for other termination options

JTISOFT® 2.0 CAPACITOR & INDUCTOR MODELING SOFTWARE

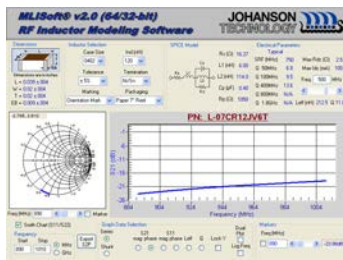

f	mag	phase	Q	ESR	Leff	Rdc	Idc
500	0.31	-71.8	0.95	18.1	0.95	18.1	0.31
545	0.29	-72.1	0.96	16.7	0.96	16.7	0.29
590	0.27	-74.3	0.96	15.6	0.96	15.6	0.27
635	0.25	-75.2	0.97	14.6	0.97	14.6	0.25
680	0.24	-75.1	0.97	13.7	0.97	13.7	0.24
725	0.22	-76.8	0.97	12.9	0.97	12.9	0.22
770	0.21	-77.5	0.98	12.3	0.98	12.3	0.21
815	0.20	-75.1	0.98	11.6	0.98	11.6	0.20
860	0.19	-78.7	0.98	11.1	0.98	11.1	0.19
905	0.18	-75.1	0.98	10.6	0.98	10.6	0.18
950	0.18	-75.6	0.98	10.1	0.98	10.1	0.18
995	0.17	-80.0	0.98	9.7	0.98	9.7	0.17
1040	0.16	-80.3	0.99	9.3	0.99	9.3	0.16
1085	0.16	-80.7	0.99	9.0	0.99	9.0	0.16

JTisoft® consists of two advanced design simulation software programs which offer component modeling from 1 MHz to 20 GHz. MLCsoft® provides S-Parameter and SPICE modeling data for six different size high frequency multi-layer ceramic capacitors (MLCCs) chip sizes while MLIssoft® provides S-Parameter and SPICE modeling on four different size high frequency multi-layer ceramic inductors (MLCIs). The main interface screen displays electrical parameters such as SRF, PRF1, PRF2, ESR, Q, Ceff, Leff, Rdc, and Idc which are updated dynamically as chip size, value, and frequency parameters are varied by the user. The complete part number is also dynamically displayed for ordering accuracy.

Both programs also provide highly detailed graphical plots of device performance over a user specified frequency range. The chart displays are instantly updated as the user makes component or frequency changes. Smith chart displays of both impedance and S11/S22 are available as point plots, line plots, and line-point plots. Traditional X-Y graphs are available for parameters of S21 and S11 both phase and magnitude, Impedance magnitude, as well as Q, ESR and effective capacitance. Display formats include standard, log Y, and log/log. Chart may be exported in BMP or Metafile format. Numerical S-Parameter data may be displayed and exported as an .S2P format file.

JTisoft® is available for download from our web site.



MULTI-LAYER HIGH-Q CAPACITORS

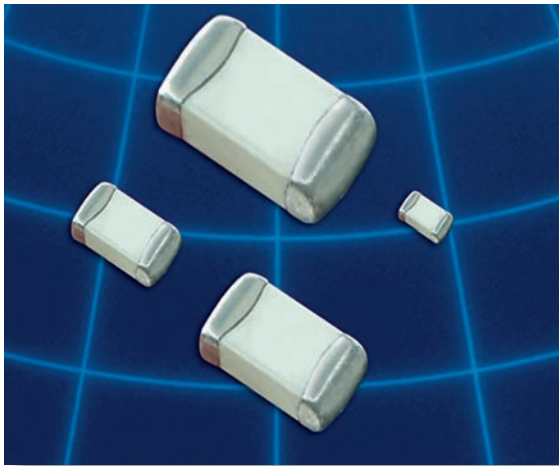

These lines of multilayer capacitors have been developed for High-Q and microwave applications.

- The **S-Series** (R07S, R14S, R15S) capacitors give an ultra-high Q performance, and exhibit NPO temperature characteristics.
- The **L-Series** (R05L) capacitors give mid-high Q performance, and exhibit NPO temperature characteristics.
- The **E-Series** (S42E, S48E, S58E) capacitors give excellent high-Q performance from HF to Microwave frequencies. Typical uses are high voltage, high current applications. They are offered in chip (Ni barrier or Non-Magnetic Pt.-Ag) or in Non-Magnetic leaded form.
- RoHS compliance is standard for all unleaded parts (see termination options box).

HOW TO ORDER

252	S48	E	470	K	V	4	E
WVDC² 250 = 25 V 201 = 200 V 251 = 250 V 501 = 500 V 102 = 1000 V 152 = 1500 V 252 = 2500 V 362 = 3600 V 722 = 7200 V	CASE SIZE R05 (0201) R07 (0402) R14 (0603) R15 (0805) S42 (1111) S48 (2525) S58 (3838)	CAPACITANCE (pF) 1st two digits are significant; third digit denotes number of zeros, R = decimal. 100 = 10 pF 101 = 100 pF	DIELECTRIC S = Ultra High Q NPO L = High Q NPO E = Ultra High Q NPO, High Voltage, High Power, T ¹ = High Temp (175C) Ultra High Q NPO	TOLERANCE A = ± 0.05 pF B = ± 0.10 pF C = ± 0.25 pF D = ± 0.50 pF F = ±1 % G = ±2% J = ±5% K = ± 10% For tolerance availability, see chart.	TERMINATION Nickel Barrier V = Ni/Sn (Green) T = Ni/SnPb G = Ni/Au (Green) Non-Mag¹ U = Cu/Sn (Green) C = Cu/SnPb Leaded (All Non-Mag)¹ 1 = Microstrip 2 = Axial Ribbon 3 = Axial Wire 4 = Radial Ribbon 5 = Radial Wire	PACKAGING S = Bulk W = Waffle Pack 0201 - 0603 Y = Paper 5" Reel T = Paper 7" Reel R ¹ = Paper 13" Reel J ¹ = Paper 5" Reel - Horizontally Oriented Electrodes N ¹ = Paper 5" Reel - Vertically Oriented Electrodes L ¹ = Paper 7" Reel - Horizontally Oriented Electrodes V ¹ = Paper 7" Reel - Vertically Oriented Electrodes 0805 - 3838 Z = Embossed 5" Reel E = Embossed 7" Reel U ¹ = Embossed 13" Reel M ¹ = Embossed 5" Reel - Horizontally Oriented Electrodes Q ¹ = Embossed 5" Reel - Vertically Oriented Electrodes G ¹ = Embossed 7" Reel - Horizontally Oriented Electrodes P ¹ = Embossed 7" Reel - Vertically Oriented Electrodes Tape specifications conform to EIA RS481	
Part Number written: 252S48E470KV4E							
MARKING 3 = Cap Code & Tolerance 4 = No Marking 6 = EIA Code (Marking option is only available on 0805 and larger case sizes)							

¹ - Not available for all MLCC - Call factory for info.
² - WVDC - Working Voltage DC.

LOW ESR / HIGH-Q CAPACITOR SELECTION CHART

EIA Size Cap. Value		RF Power Applications												
		0201 (R05)		0402	0603	0805	0805	1111	2525	3838				
		NPO (R05L)	NPO (R05G)	(R07S)	(R14S)	(R15S)	(R15G)	(S42E)	(S48E)	(S58E)				
Capacitance pF	Code													
0.1	0R1													
0.2	0R2	25 V	25 V	200 V	250 V			500V	1500V					
0.3	0R3	25 V	25 V	200 V	250 V	250 V	1000V	500V	1500V					
0.4	0R4	25 V	25 V	200 V	250 V	250 V	1000V	500V	1500V					
0.5	0R5	25 V	25 V	200 V	250 V	250 V	1000V	500V	1500V	2500V				
0.6	0R6	25 V	25 V	200 V	250 V	250 V	1000V	500V	1500V	2500V	3600V	7200V		
0.7	0R7	25 V	25 V	200 V	250 V	250 V	1000V	500V	1500V	2500V	3600V	7200V		
0.8	0R8	25 V	25 V	200 V	250 V	250 V	1000V	500V	1500V	2500V	3600V	7200V		
0.9	0R9	25 V	25 V	200 V	250 V	250 V	1000V	500V	1500V	2500V	3600V	7200V		
1.0	1R0	25 V	25 V	200 V	250 V	250 V	1000V	500V	1500V	2500V	3600V	7200V		
1.1	1R1	25 V	25 V	200 V	250 V	250 V	1000V	500V	1500V	2500V	3600V	7200V		
1.2	1R2	25 V	25 V	200 V	250 V	250 V	1000V	500V	1500V	2500V	3600V	7200V		
1.3	1R3	25 V	25 V	200 V	250 V	250 V	1000V	500V	1500V	2500V	3600V	7200V		
1.4	1R4	25 V	25 V	200 V	250 V	250 V	1000V	500V	1500V	2500V	3600V	7200V		
1.5	1R5	25 V	25 V	200 V	250 V	250 V	1000V	500V	1500V	2500V	3600V	7200V		
1.6	1R6	25 V	25 V	200 V	250 V	250 V	1000V	500V	1500V	2500V	3600V	7200V		
1.7	1R7	25 V	25 V	200 V	250 V	250 V	1000V	500V	1500V	2500V	3600V	7200V		
1.8	1R8	25 V	25 V	200 V	250 V	250 V	1000V	500V	1500V	2500V	3600V	7200V		
1.9	1R9	25 V	25 V	200 V	250 V	250 V	1000V	500V	1500V	2500V	3600V	7200V		
2.0	2R0	25 V	25 V	200 V	250 V	250 V	1000V	500V	1500V	2500V	3600V	7200V		
2.1	2R1	25 V	25 V	200 V	250 V	250 V	1000V	500V	1500V	2500V	3600V	7200V		
2.2	2R2	25 V	25 V	200 V	250 V	250 V	1000V	500V	1500V	2500V	3600V	7200V		
2.4	2R4	25 V	25 V	200 V	250 V	250 V	1000V	500V	1500V	2500V	3600V	7200V		
2.7	2R7	25 V	25 V	200 V	250 V	250 V	1000V	500V	1500V	2500V	3600V	7200V		
3.0	3R0	25 V	25 V	200 V	250 V	250 V	1000V	500V	1500V	2500V	3600V	7200V		
3.3	3R3	25 V	25 V	200 V	250 V	250 V	1000V	500V	1500V	2500V	3600V	7200V		
3.6	3R6	25 V	25 V	200 V	250 V	250 V	1000V	500V	1500V	2500V	3600V	7200V		
3.9	3R9	25 V	25 V	200 V	250 V	250 V	1000V	500V	1500V	2500V	3600V	7200V		
4.3	4R3	25 V	25 V	200 V	250 V	250 V	1000V	500V	1500V	2500V	3600V	7200V		
4.7	4R7	25 V	25 V	200 V	250 V	250 V	1000V	500V	1500V	2500V	3600V	7200V		
5.1	5R1	25 V	25 V	200 V	250 V	250 V	1000V	500V	1500V	2500V	3600V	7200V		
5.6	5R6	25 V	25 V	200 V	250 V	250 V	1000V	500V	1500V	2500V	3600V	7200V		
6.2	6R2	25 V	25 V	200 V	250 V	250 V	1000V	500V	1500V	2500V	3600V	7200V		
6.8	6R8	25 V	25 V	200 V	250 V	250 V	1000V	500V	1500V	2500V	3600V	7200V		
7.5	7R5	25 V	25 V	200 V	250 V	250 V	1000V	500V	1500V	2500V	3600V	7200V		
8.2	8R2	25 V	25 V	200 V	250 V	250 V	1000V	500V	1500V	2500V	3600V	7200V		
9.1	9R1	25 V	25 V	200 V	250 V	250 V	1000V	500V	1500V	2500V	3600V	7200V		
10	100	25 V	25 V	200 V	250 V	250 V	1000V	500V	1500V	2500V	3600V	7200V		
11	110	25 V	25 V	200 V	250 V	250 V	1000V	500V	1500V	2500V	3600V	7200V		
12	120	25 V	25 V	200 V	250 V	250 V	1000V	500V	1500V	2500V	3600V	7200V		
13	130	25 V	25 V	200 V	250 V	250 V	1000V	500V	1500V	2500V	3600V	7200V		
15	150	25 V	25 V	200 V	250 V	250 V	1000V	500V	1500V	2500V	3600V	7200V		
16	160	25 V	25 V	200 V	250 V	250 V	1000V	500V	1500V	2500V	3600V	7200V		
18	180	25 V	25 V	200 V	250 V	250 V	1000V	500V	1500V	2500V	3600V	7200V		
20	200	25 V		200 V	250 V	250 V	1000V	500V	1500V	2500V	3600V	7200V		
22	220	25 V		200 V	250 V	250 V	1000V	500V	1500V	2500V	3600V	7200V		
24	240	25 V		200 V	250 V	250 V	1000V	500V	1500V	2500V	3600V	7200V		
27	270	25 V		200 V	250 V	250 V	1000V	500V	1500V	2500V	3600V	7200V		
30	300	25 V		200 V	250 V	250 V	1000V	500V	1500V	2500V	3600V	7200V		
33	330	25 V		200 V	250 V	250 V	1000V	500V	1500V	2500V	3600V	7200V		

Consult factory for Non-Standard values.

**A tolerance only available for R07S (0402) and R14S(0603) caps

LOW ESR / HIGH-Q CAPACITOR SELECTION CHART

EIA Size Cap. Value			RF Power Applications										
			0201 (R05)		0402	0603	0805	0805	1111	2525	3838		
			NPO (R05L)	NPO (R05G)	(R07S)	(R14S)	(R15S)	(R15G)	(S42E)	(S48E)	(S58E)		
Capacitance pF	Code	Tolerance											
36	360	F	25 V			250 V	250 V	1000V	500V	1500V	2500V	3600V	7200V
39	390		25 V			250 V	250 V	1000V	500V	1500V	2500V	3600V	7200V
43	430		25 V			250 V	250 V	1000V	500V	1500V	2500V	3600V	7200V
47	470		25 V			250 V	250 V	1000V	500V	1500V	2500V	3600V	7200V
51	510		25 V			250 V	250 V	1000V	500V	1500V	2500V	3600V	7200V
56	560		25 V			250 V	250 V	1000V	500V	1500V	2500V	3600V	7200V
62	620		25 V			250 V	250 V	1000V	500V	1500V	2500V	3600V	7200V
68	680		25 V			250 V	250 V	1000V	500V	1500V	2500V	3600V	7200V
75	750		25 V			250 V	250 V	1000V	500V	1500V	2500V	3600V	7200V
82	820		25 V			250 V	250 V	1000V	500V	1500V	2500V	3600V	7200V
91	910		25 V			250 V	250 V	1000V	500V	1500V	2500V	3600V	7200V
100	101		25 V			250 V	250 V	1000V	500V	1500V	2500V	3600V	7200V
110	111						250 V		300V	1500V	2500V	3600V	7200V
120	121							250 V	300V	1000V	2500V	3600V	7200V
130	131							250 V	300V	1000V	2500V	3600V	7200V
150	151							250 V	300V	1000V	2500V	3600V	7200V
160	161							250 V	300V	1000V	2500V	3600V	7200V
180	181							250 V	300V	1000V	2500V	3600V	7200V
200	201						250 V	300V	1000V	2500V	3600V		
220	221						250 V	200V	1000V	2500V	3600V		
240	241							200V	1000V	2500V	3600V		
270	271							200V	1000V	2500V	3600V		
300	301							200V	1000V	1500V	3600V		
330	331							200V	1000V	1500V	3600V		
360	361							200V	1000V	1500V	3600V		
390	391							200V	500V	1500V	3600V		
430	431							200V	500V	1500V	2500V		
470	471							200V	500V	1500V	2500V		
510	511							100V	500V	1000V	2500V		
560	561							100V	500V	1000V	2500V		
620	621							100V	500V	1000V	2500V		
680	681							50V		1000V	2500V		
750	751							50V		1000V	2500V		
820	821	G						50V		1000V	2500V		
910	911								50V		1000V	1000V	
1000	102								50V		1000V	1000V	
1200	122										1000V	1000V	
1500	152										500V	1000V	
1800	182										500V	1000V	
2200	222										300V	1000V	
2700	272										300V	500V	
3300	332											500V	
3900	392											500V	
4700	472										500V		
5100	512										500V		
10000	103												

Consult factory for Non-Standard values.

DIELECTRIC CHARACTERISTICS

NPO

TEMPERATURE COEFFICIENT:	0 ± 30ppm /°C, -55 to 125°C
QUALITY FACTOR / DF:	Q >1,000 @ 1KHz (C>1,000pF), Typical 10,000 (C<1,000 pF)
INSULATION RESISTANCE:	>100 GΩ @ 25°C, WVDC ¹ ; 125°C IR is 10% of 25°C rating
DIELECTRIC STRENGTH:	500 V ≤ 2.5 X WVDC ¹ Min., 25°C, 50 mA max 1000 V ≤ 1.5 X WVDC ¹ Min., 25°C, 50 mA max > 1500 = 1 X WVDC ¹ Min., 25°C, 50 mA max
TEST PARAMETERS::	1MHz ±50kHz, 1.0±0.2 VRMS, 25°C
AVAILABLE CAPACITANCE:	
Size 0201:	0.2 - 100 pF
Size 0402:	0.2 - 33 pF
Size 0603:	0.2 - 100 pF
Size 0805:	0.3 - 220 pF
Size 1111:	0.2 - 1000 pF
Size 2525:	1.0 - 2700 pF
Size 3838:	1.0 - 5100 pF

MECHANICAL & ENVIRONMENTAL CHARACTERISTICS

	SPECIFICATION	TEST PARAMETERS
SOLDERABILITY:	Solder coverage ≥ 90% of metalized areas No termination degradation	Preheat chip to 120°-150°C for 60 sec., dip terminals in rosin flux then dip in Sn62 solder @ 240°±5°C for 5±1 sec
RESISTANCE TO SOLDERING HEAT:	No mechanical damage Capacitance change: ±2.5% or 0.25pF Q>500 I.R. >10 G Ohms DWV ² : 2.5 x WVDC ¹	Preheat device to 80°-100°C for 60 sec. followed by 150°-180°C for 60 sec. Dip in 260°±5°C solder for 10±1 sec. Measure after 24±2 hour cooling period
TERMINAL ADHESION:	Termination should not pull off. Ceramic should remain undamaged.	Linear pull force ³ exerted on axial leads soldered to each terminal.
PCB DEFLECTION:	No mechanical damage. Capacitance change: 2% or 0.5pF Max	Glass epoxy PCB: 0.5 mm deflection
LIFE TEST:	MIL-STD-202, Method 108I No mechanical damage Capacitance change: ±3.0% or 0.3 pF Q>500 I.R. >1 G Ohms DWV ² : 2.5 x WVDC ¹	Applied voltage: 200% of WVDC ¹ for capacitors rated at 500 volts DC or less. 100% of WVDC ¹ for capacitors rated at 1250 volts DC or less. Temperature: 125°±3°C Test time: 1000+48-0 hours
THERMAL CYCLE:	No mechanical damage. Capacitance change: ±2.5% or 0.25pF Q>2000 I.R. >10 G Ohms DWV ² : 2.5 x WVDC ¹	5 cycles of: 30±3 minutes @ -55°+0/-3°C, 2-3 min. @ 25°C, 30±3 min. @ +125°+3/-0°C, 2-3 min. @ 25°C Measure after 24±2 hour cooling period
HUMIDITY, STEADY STATE:	No mechanical damage. Capacitance change: ±5.0% or 0.50pF max. Q>300 I.R. ≥ 1 G-Ohm DWV ² : 2.5 x WVDC ¹	Relative humidity: 90-95% Temperature: 40°±2°C Test time: 500 +12/-0 Hours Measure after 24±2 hour cooling period
HUMIDITY, LOW VOLTAGE:	No mechanical damage. Capacitance change: ±5.0% or 0.50pF max. Q>300 I.R. = 1 G-Ohm min. DWV ² : 2.5 x WVDC ¹	Applied voltage: 1.5 VDC, 50 mA max. Relative humidity: 85±2% Temperature: 40°±2°C Test time: 240 +12/-0 Hours Measure after 24±2 hour cooling period
VIBRATION:	No mechanical damage. Capacitance change: ±2.5% or 0.25pF Q>1000 I.R. ≥ 10 G-Ohm DWV ² : 2.5 x WVDC ¹	Cycle performed for 2 hours in each of three perpendicular directions Frequency range 10Hz to 55 Hz to 10 Hz traversed in 1 minute. Harmonic motion amplitude: 1.5mm

¹ - WVDC - Working Voltage DC.

² - DWV - Dielectric Withstanding Voltage.

³ - 0402 ≥ 2.0lbs, 0603 ≥ 4.0lbs (min).

⁴ - Whichever is less.

MECHANICAL CHARACTERISTICS

Size	Units	Length	Width	Thickness	End Band
EIA 0201	In	.024 ±.001	.012 ±.001	.012 ±.001	.008 Max.
Metric (0603)	mm	(0.60 ±0.03)	(0.30 ±0.03)	(0.30 ±0.03)	(0.20 Max.)
EIA 0402	In	.040 ±.004	.020 ±.004	.020 ±.004	.010 ±.006
Metric (1005)	mm	(1.02 ±0.1)	(0.51 ±0.1)	(0.51 ±0.1)	(0.25 ±.15)
EIA 0603	In	.062 ±.006	.032 ±.006	.030 +.005/-.003	.014 ±.006
Metric (1608)	mm	(1.57 ±0.15)	(0.81 ±0.15)	(0.76 +.13-.08)	(0.35 ±.15)
EIA 0805	In	.080 ±.008	.050 ±.008	.040 ±.006	.020 ±.010
Metric (2012)	mm	(2.03 ±0.20)	(1.27 ±0.20)	(1.02 ±.15)	(0.50 ±.25)

HORIZONTAL AND VERTICAL ORIENTED CAPACITORS

Horizontal Electrode Orientation

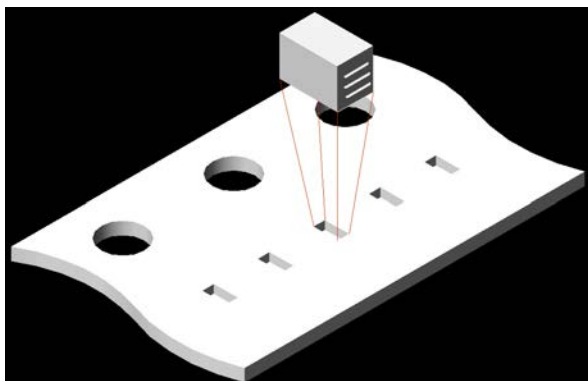

Vertical Electrode Orientation

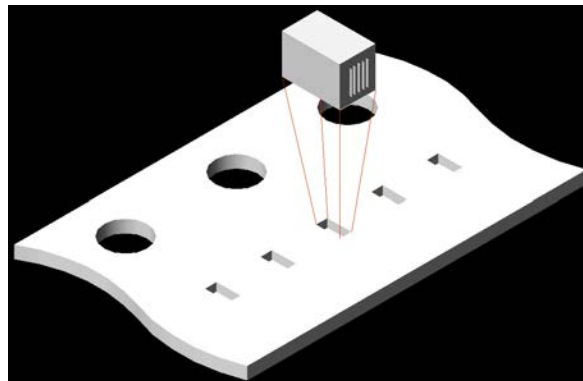

APPLICATIONS & FEATURES

Size:	EIA 0201, 0402
Performance:	SRF's up to 20 GHz, Ultra High Q, Tight tolerance, Ultralow ESR
Termination:	Ni/Au, Ni/Sn, Ni/SnPb
Applications:	High Frequency Wireless Communications, Portable Wireless Products, Battery Powered Products

RoHS Compliant

BENEFITS OF USING ORIENTED CAPACITORS

- Consistent Orientation - Improved repeatability of production circuits.
- Consistent Orientation - More consistent filter performance.
- Vertical Orientation - The elimination of parallel frequencies.
- Vertical Orientation - Lower inductance for a given capacitor.
- Horizontal Orientation - Lower coupling between adjacent capacitors.

E-SERIES TERMINATIONS AND LEADS

CHIP DIMENSIONS

Termination	Size	Units	L	Tol	W	Tol	T	E / B	Tol
V, T U, C	S42E	In	0.110	+0.020 -0.010	0.110	+/- .015	0.102 Max.	0.015 Typ.	+/- 0.008
		mm	2.79	+0.51 -0.25	2.79	+/- 0.38	2.59 Max.	0.38 Typ.	+/- 0.20
	S48E	In	0.230	+0.025 -0.010	0.250	+/- .015	0.150 Max.	0.025 Typ.	
		mm	5.84	+0.63 -0.25	6.35	+/- 0.38	3.81 Max.	0.63 Typ.	
	S58E	In	0.380	+0.015 -0.010	0.380	+/- .010	0.170 Max.	0.025 Typ.	
		mm	9.65	+0.38 -0.25	9.65	+/- 0.25	4.32 Max.	0.63 Typ.	

For all E-Series Models:

OPERATING TEMP. : -55 to +125°C
 INSULATION RESISTANCE: >10G Ω @ 25°C
 TEMPERATURE COEFFICIENT: 0 ± 30ppm /°C, -55 to 125°C
 DISSIPATION FACTOR (TYP): < 0.05% @ 1 MHz

Drawings not to scale

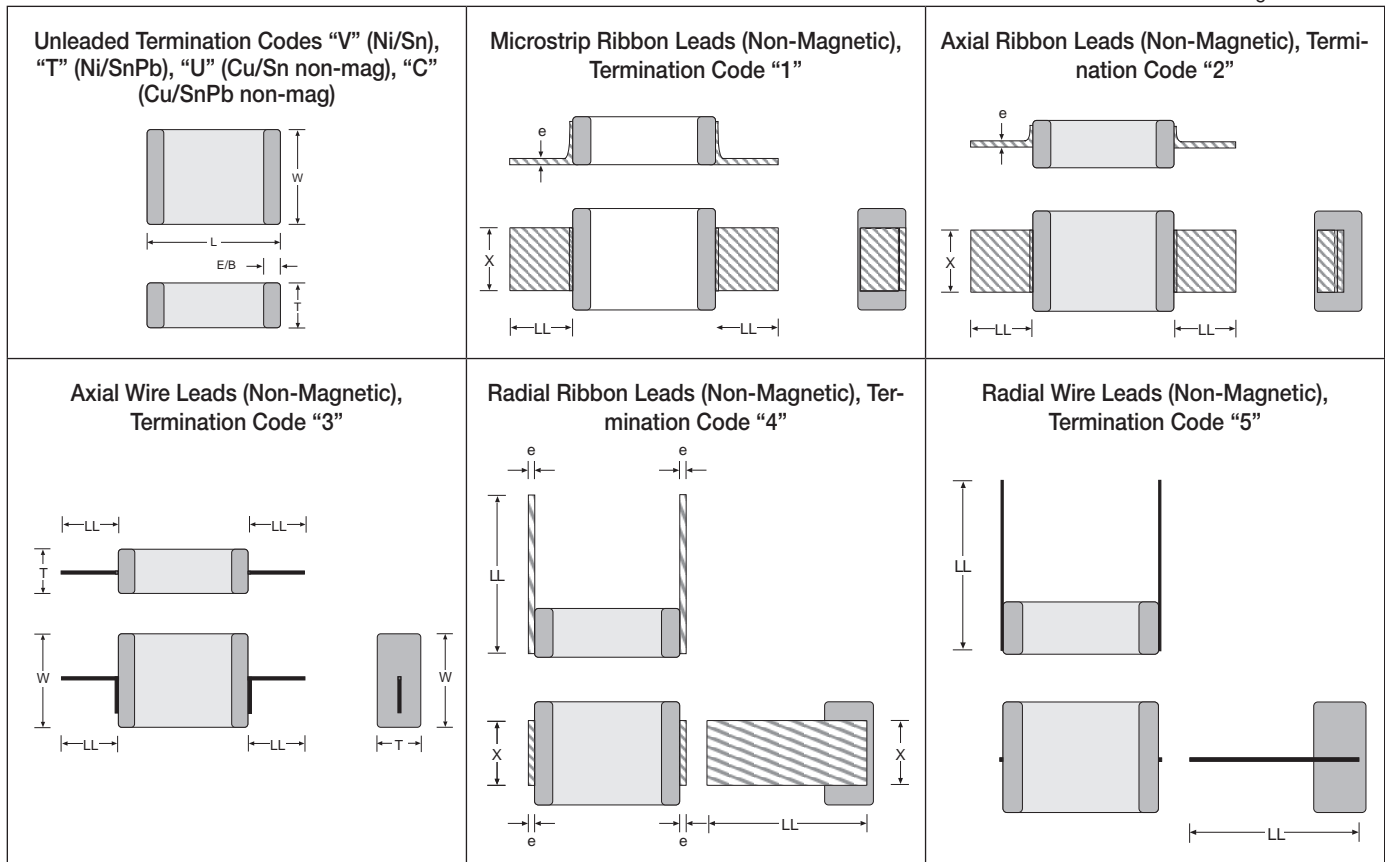

Lead	Size	LL(min)	X	Tol	e	e-Tol
1	S42E	0.25	0.093	+/-0.005	0.004	+/- 0.002
		6.40	2.36	+/- 0.13	0.102	+/- 0.051
	S48E	0.394	0.217	+/- 0.02	0.009	- 0.0019/+ 0.0031
		10.0	5.5	+/- 0.50	0.220	- 0.050/+ 0.080
	S58E	0.748	0.35	+/- 0.02	0.010	- 0.0019/+ 0.0039
		19.00	8.90	+/- 0.50	0.250	- 0.050/+ 0.100
2	S42E	0.25	0.093	+/-0.005	0.004	+/- 0.002
		6.40	2.36	+/- 0.13	0.102	+/- 0.051
	S48E	0.394	0.217	+/- 0.02	0.009	- 0.0019/+ 0.0031
		10.00	5.50	+/- 0.50	0.220	- 0.050/+ 0.080
	S58E	0.748	0.35	+/- 0.02	0.010	- 0.0019/+ 0.0039
		19.00	8.90	+/- 0.50	0.25	- 0.050/+ 0.100
3	S42E	0.25	0.020in (0.511) diameter wire			
		6.40				
	S48E	0.394				
		10.00				
S58E	0.748					
	19.00					

Lead	Size	LL(min)	X	Tol	e	e-Tol
4	S42E	0.352	0.093	+/-0.005	0.004	+/- 0.002
		8.90	2.36	+/- 0.13	0.102	+/- 0.051
	S48E	0.501	0.217	+/- 0.02	0.009	- 0.0019/+ 0.0031
		12.70	5.50	+/- 0.50	0.220	- 0.050/+ 0.080
	S58E	0.886	0.35	+/- 0.02	0.010	- 0.0019/+ 0.0039
		22.50	8.90	+/- 0.50	0.25	- 0.050/+ 0.100
5	S42E	0.25	0.020in (0.511) diameter wire			
		6.40				
	S48E	0.394				
		10.00				
S58E	0.748					
	19.00					

SERIES RESONANCE CHART

Typical Series Resonant Frequency (Series Mounted)

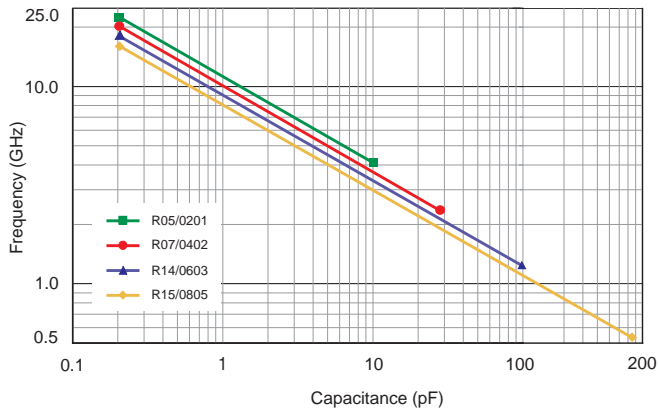

RF CHARACTERISTICS - L-SERIES

ESR vs Frequency: 0201/R05L

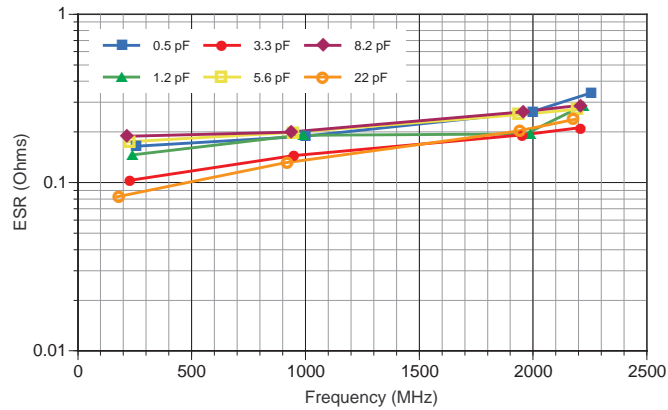

Q vs Frequency: 0201/R05L

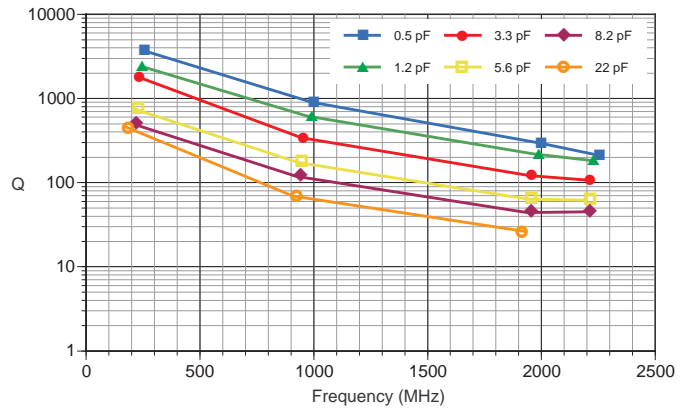

ESR vs Capacitance: 0201/R05L

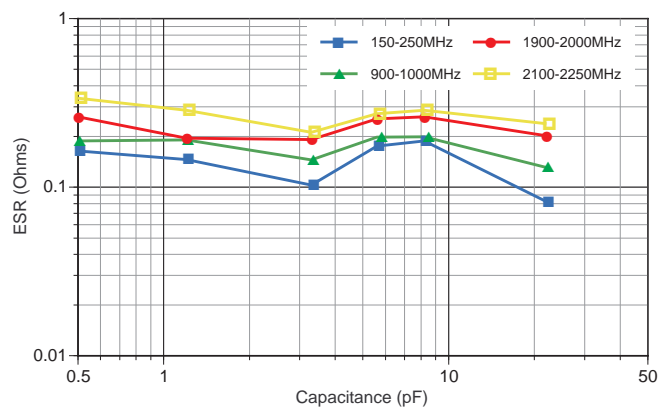

Q vs Capacitance: 0201/R05L

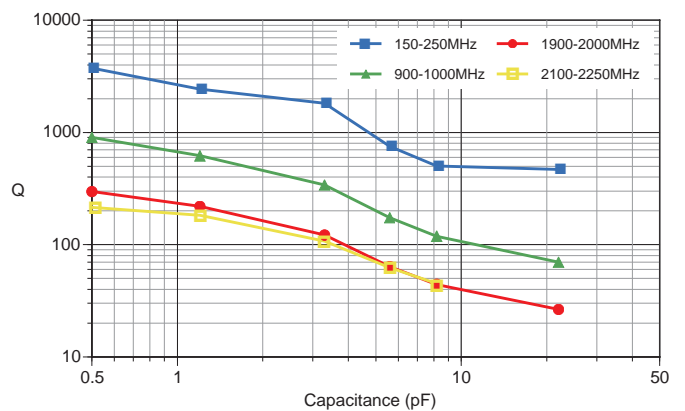

S-SERIES RF CHARACTERISTICS VERSUS FREQUENCY

Equivalent Series Resistance: 0402/R07S

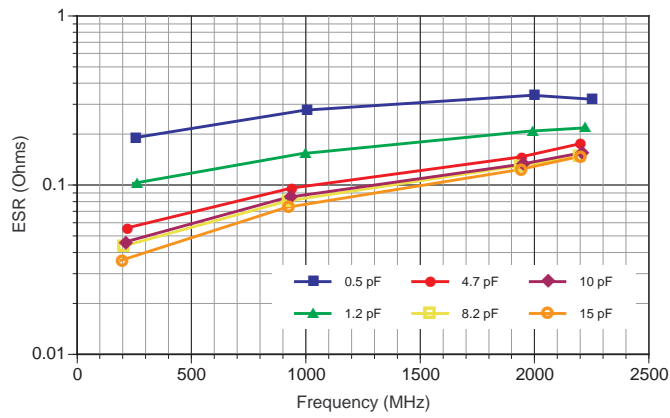

Q Factor: 0402/R07S

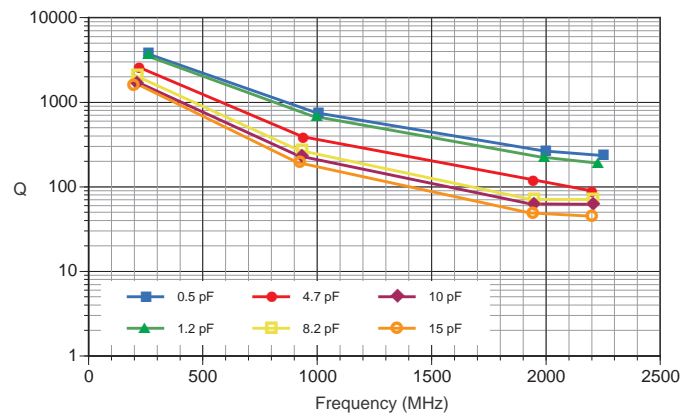

Equivalent Series Resistance: 0603/R14S

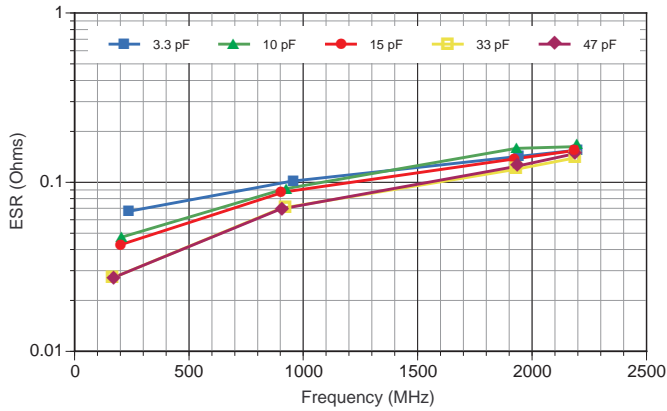

Q Factor: 0603/R14S

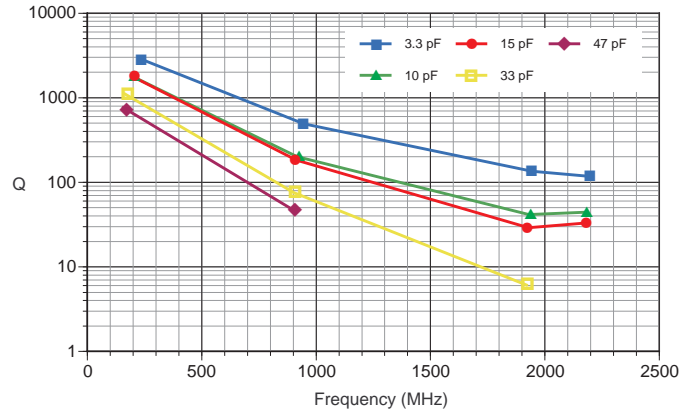

Equivalent Series Resistance: 0805/R15S

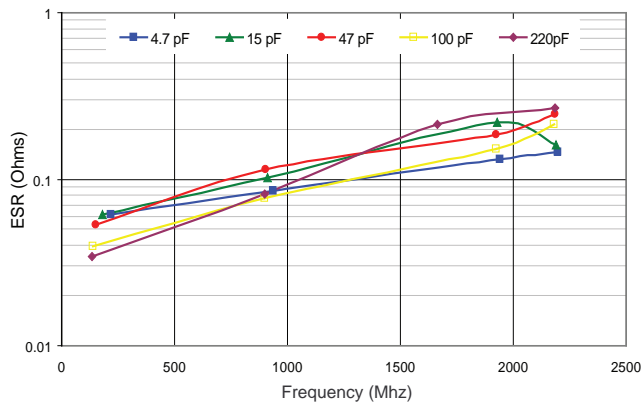

Q Factor: 0805/R15S

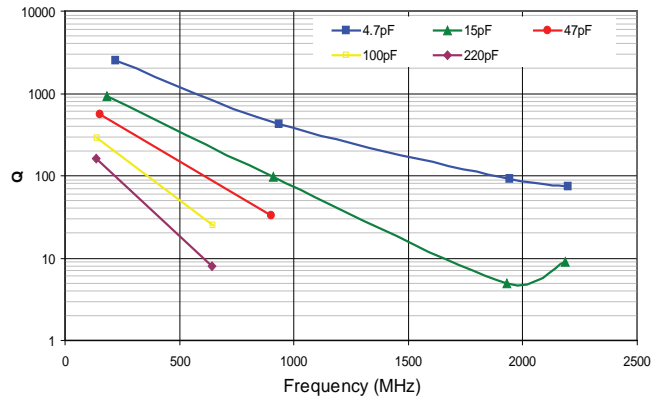

Measurements performed on a Boonton 34A Resonant Coaxial Line and represent typical capacitor performance.

S-SERIES RF CHARACTERISTICS VERSUS CAPACITANCE

Equivalent Series Resistance: 0402/R07S

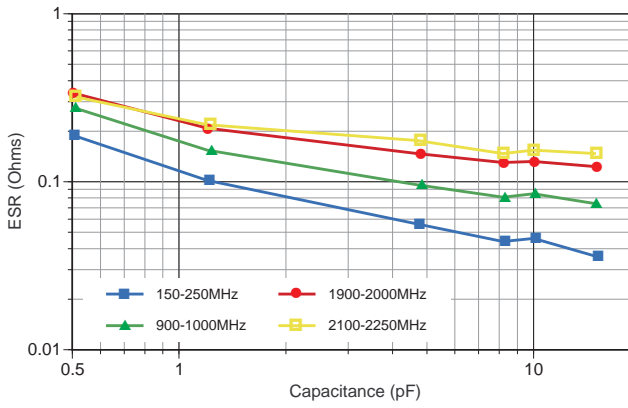

Q Factor: 0402/R07S

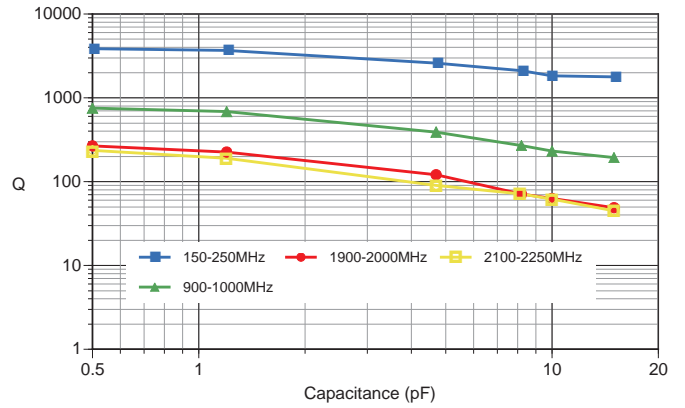

Equivalent Series Resistance: 0603/R14S

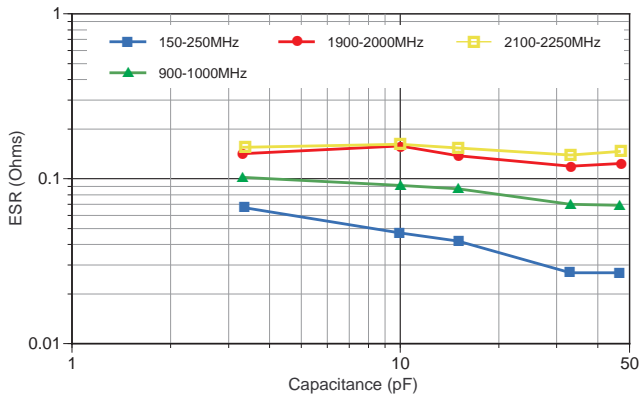

Q Factor: 0603/R14S

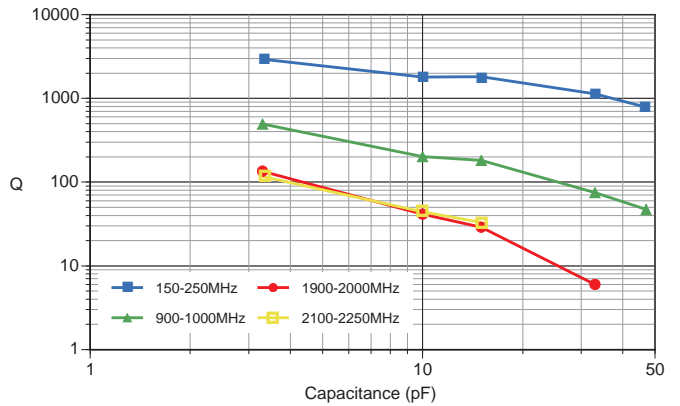

Equivalent Series Resistance: 0805/R15S

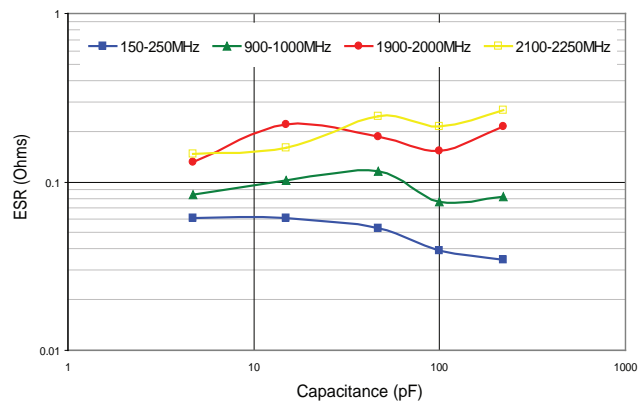

Q Factor: 0805/R15S

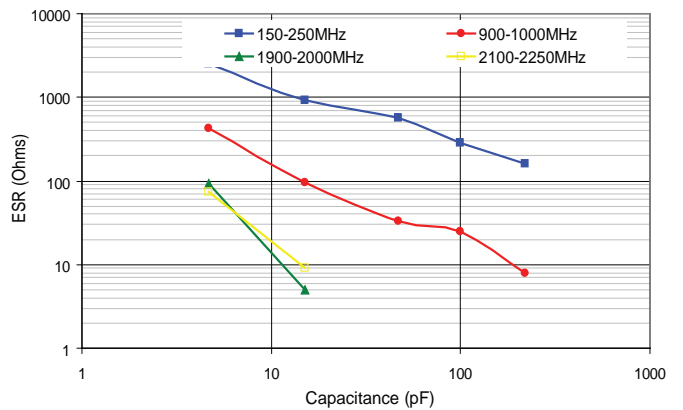

Measurements performed on a Boonton 34A Resonant Coaxial Line and represent typical capacitor performance.

S42E SERIES RF CHARACTERISTICS VERSUS FREQUENCY

Equivalent Series Resistance: 1111/S42E

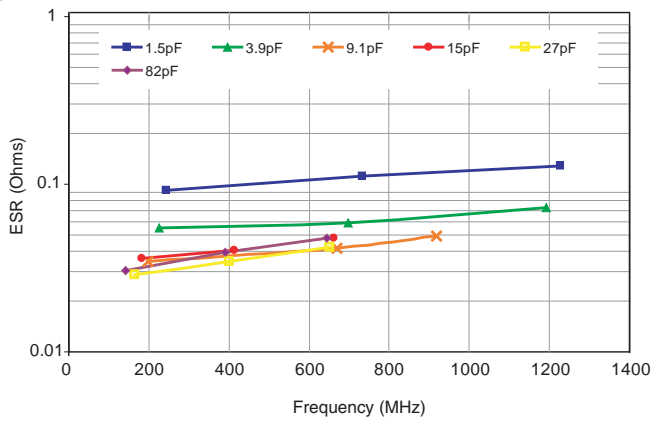

Q Factor: 1111/S42E

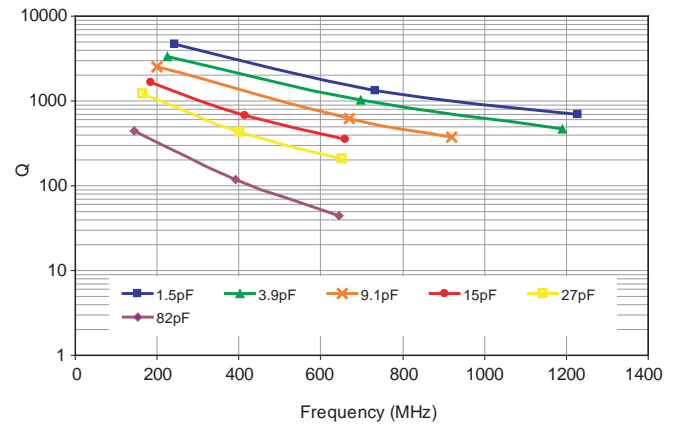

S42E SERIES RF CHARACTERISTICS VERSUS CAPACITANCE

S42E Equivalent Series Resistance vs Capacitance, Typical

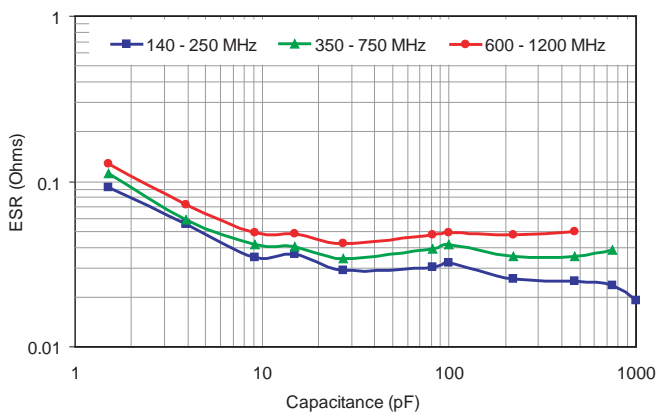

S42E Q vs. Capacitance, Typical

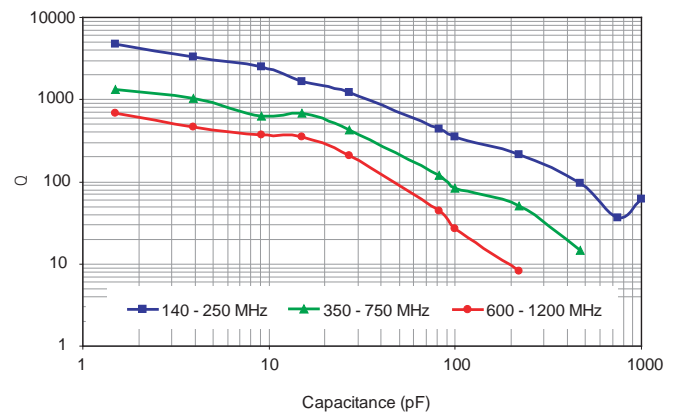

S42E SRF (Series Mount), Typical

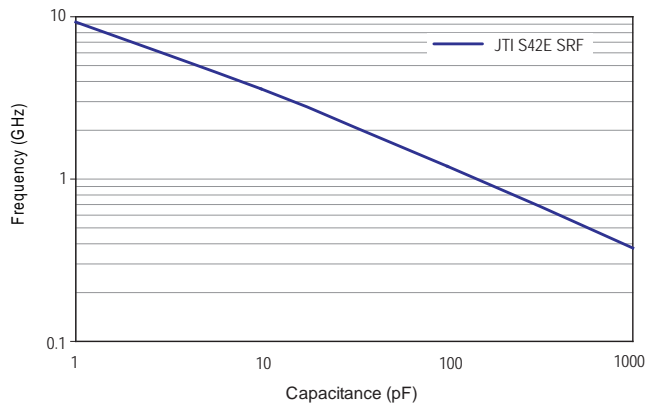

SRF (Shunt Mount), S48E, Typical (Preliminary)

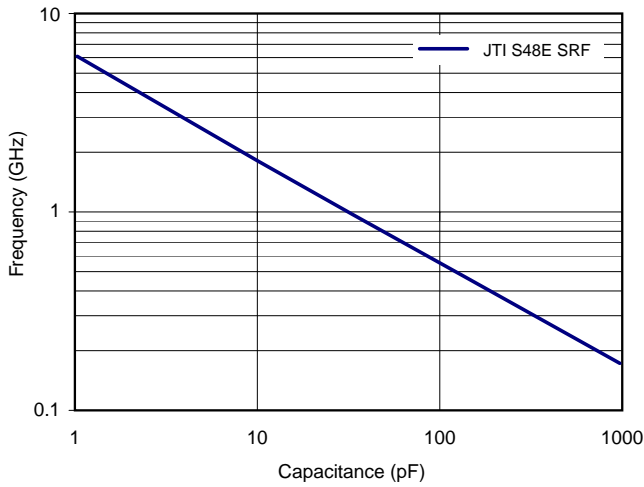

As measured on a 8720C VNA, using a Shunt-Through fixture, and using the S11 magnitude dip to determine the SRF

Current Rating vs. Capacitance, S48E, Typical (Preliminary)

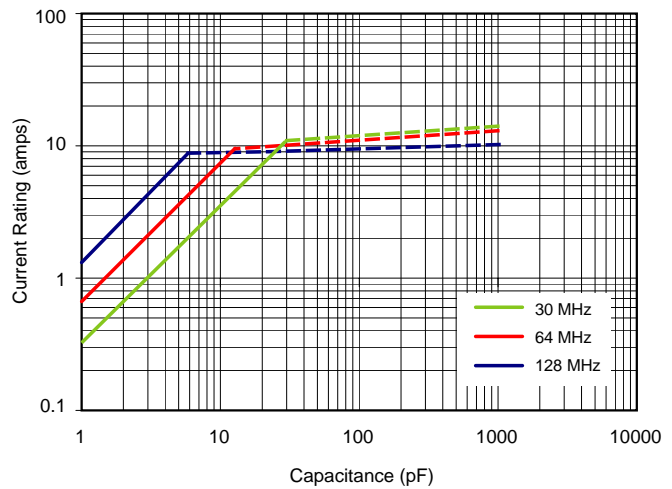

Solid traces show voltage limited current (Vrms)

Dotted traces show power dissipation limited current (Based on 4 Watts Power Dissipation, and 125 degrees C case temp.)

S48E Q vs. Capacitance, Typical (Preliminary)

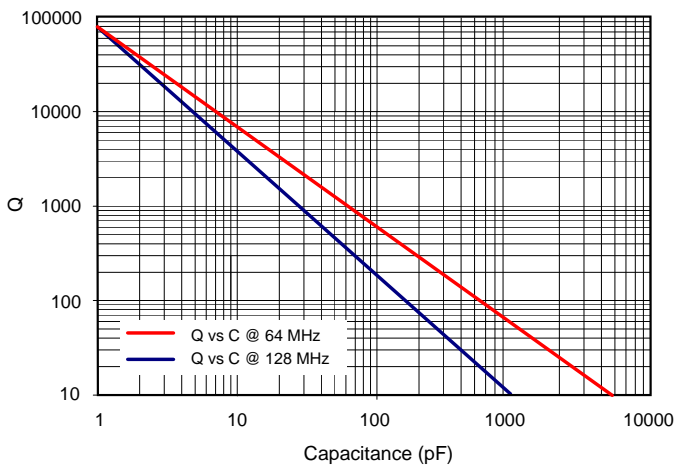

As measured on a 4287A LCR meter, using a 16092A fixture

S48E ESR vs. Capacitance, Typical (Preliminary)

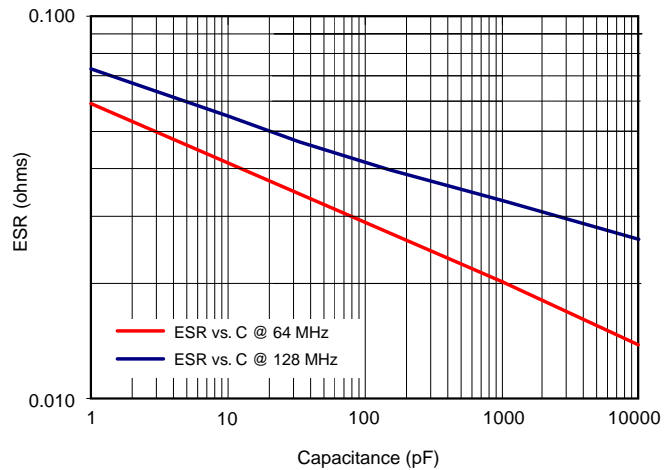

As measured on a 4287A LCR meter, using a 16092A fixture

JTI S48E GRAPHICAL DATA

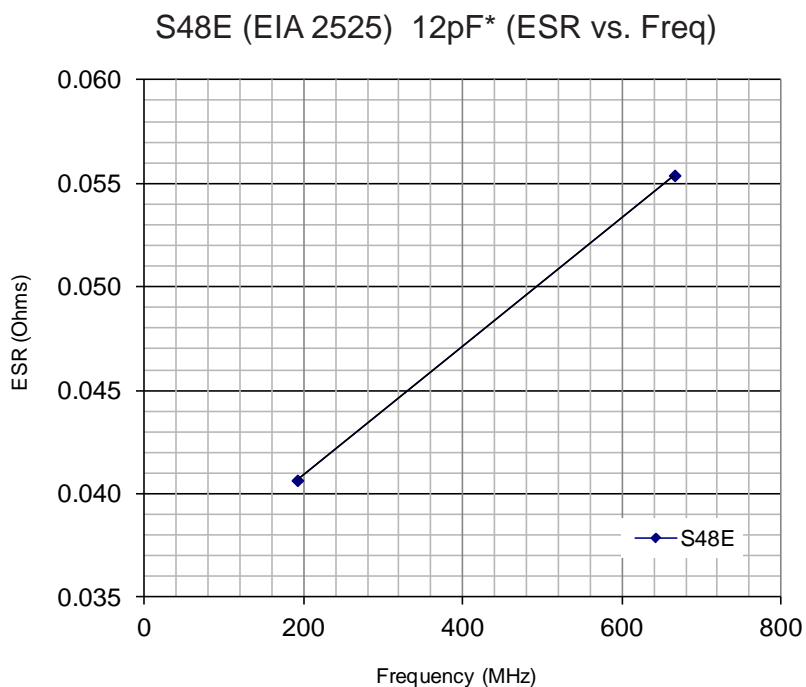

*Actual data from Boonton 34A resonant line.

JTI S58E GRAPHICAL DATA

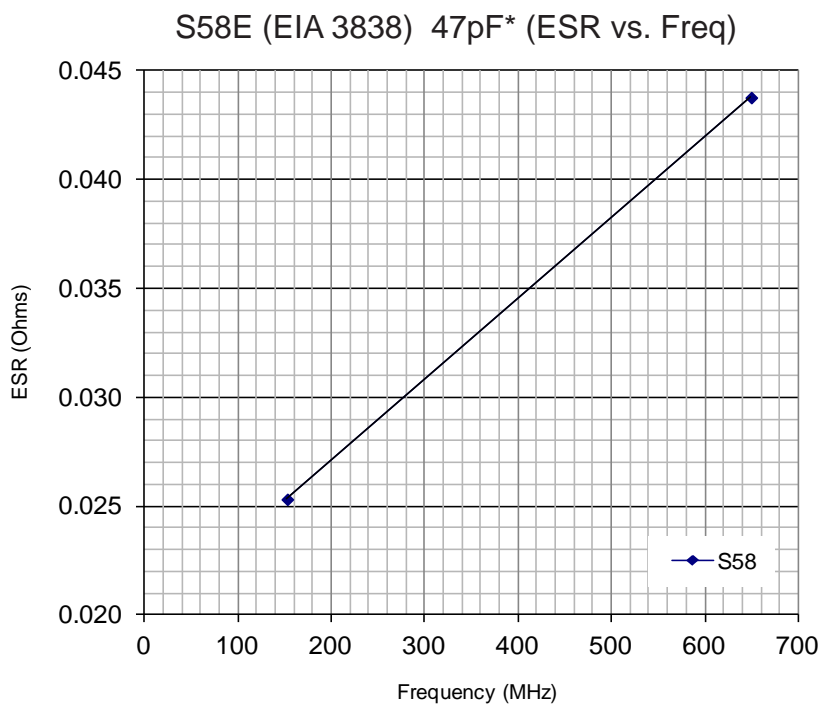

*Actual data from Boonton 34A resonant line.

RF CERAMIC CHIP INDUCTORS

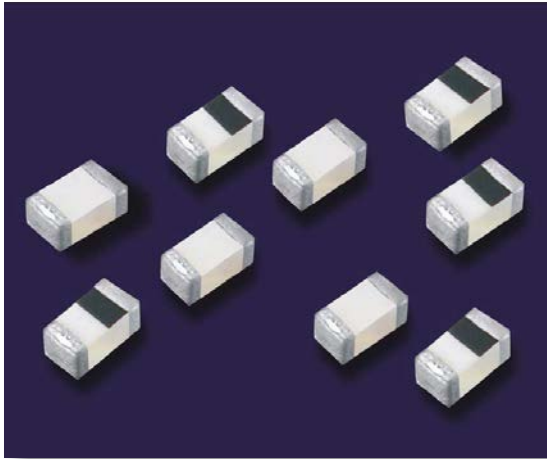

Polarity Half-Marked Inductors (0201 only)

High frequency multi-layer chip inductors feature a monolithic body made of low loss ceramic and high conductivity metal electrodes to achieve optimal high frequency performance.

These RF chip inductors are compact in size and feature lead-free tin plated nickel barrier terminations and tape and reel packaging which makes them ideal for small size/high volume wireless applications.

APPLICATIONS & FEATURES

- CELL/PCS Modules
- Broadband Components
- RF Tranceivers
- RoHS Compliant (Standard, "V" Code)
- Sn/Pb Terminations Optional ("T" Code)
- Wireless LAN
- RFID

PRODUCT RANGE SUMMARY

EIA SIZE (mm)	SIZE CODE	L RANGE	Q FACTOR (Min.)	SRF (Typ.)	TEMPERATURE
0201 (0603)	L-05	0.6 - 39 nH	4 (100 MHz)	>21 GHz (1.0 nH)	-40°C to +100°C
0402 (1005)	L-07	1.0 - 120 nH	8 (100 MHz)	>21 GHz (1.0 nH)	-40°C to +100°C
0603 (1608)	L-14	1.0 - 220 nH	12 (100 MHz)	>23 GHz (1.0 nH)	-40°C to +100°C

MECHANICAL CHARACTERISTICS

	0201 (0603)		0402 (1005)		0603 (1608)	
	Inches	mm	Inches	mm	Inches	mm
Length	.024 ±.001"	(0.6 ±0.03)	.039 ±.004"	(1.00 ±.10)	.063 ±.006"	(1.60 ±.15)
Width	.012 ±.001"	(0.3 ±0.03)	.020 ±.004"	(0.50 ±.10)	.031 ±.006"	(0.80 ±.15)
Thickness	.012 ±.001"	(0.3 ±0.03)	.020 ±.004"	(0.50 ±.10)	.031 ±.006"	(0.80 ±.15)
End Band	.006 ±.002"	(0.15 ±0.05)	.009 ±.004"	(0.23 ±.10)	.012 ±.008"	(0.30 ±.20)

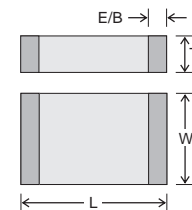

HOW TO ORDER

DEVI	SIZE	TYPE	VALUE	TOLERANCE	TERMINATION	MARKING	PACKAGING
Inductor	05 = 0201 07 = 0402 14 = 0603	B = Polarity Half-Marked (all 0201) C = 0402 and 0603 (see "Marking")	See Table	C = ± 0.2 nH ≤ 1.0 nH S = ± 0.3 nH 1.0 to 5.6 nH J = ± 5% 6.8 nH and above K = ± 10% 3.3 nH and above	V = Ni/Sn T = Ni / SnPb	4 = No Marking (all 0603) 6 = Orientation Mark (all 0201 and 0402*)	Tape and Reel Size Code Tape Reel Qty 0201 T Paper 7" 15,000 0402 T Paper 7" 10,000 0603 T Paper 7" 4,000 Bulk (Loose Pcs.) Size Code All S

Part number written: L-07C10NJV6T

Orientation Full Marking (all 0402)

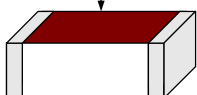

*Please note that all 0402 inductors (L-07C) have orientation full marking only.

RF CHIP INDUCTOR SELECTION CHART

EIA Size			0201 (L-05)	0402 (L-07)	0603 (L-14)
Inductor Value	Inductance nH	Code	Tolerance		
	0.6	0N6	300 mA		
	0.7	0N7	300 mA		
	0.8	0N8	300 mA		
	0.9	0N9	300 mA		
	1.0	1N0	300 mA	300 mA	300 mA (S only)
	1.2	1N2	300 mA	300 mA (S only)	300 mA (S only)
	1.3	1N3	300 mA		
	1.5	1N5	300 mA	300 mA (S only)	300 mA (S only)
	1.8	1N8	300 mA	300 mA	300 mA
	1.9	1N9	300 mA	300 mA	
	2.0	2N0	300 mA	300 mA	
	2.2	2N2	300 mA	300 mA	300 mA
	2.3	2N3	300 mA		
	2.4	2N4	300 mA	300 mA	
	2.5	2N5	300 mA		
	2.7	2N7	300 mA	300 mA	300 mA
	3.0	3N0	300 mA	300 mA	
	3.3	3N3	300 mA	300 mA	300 mA
	3.6	3N6	300 mA	300 mA	
	3.7	3N7	300 mA		
	3.9	3N9	300 mA	300 mA	300 mA
	4.3	4N3		300 mA	
	4.7	4N7	300 mA	300 mA	300 mA
	5.1	5N1	300 mA	300 mA	
	5.6	5N6	300 mA	300 mA	300 mA
	6.2	6N2		300 mA	
	6.8	6N8	250 mA	250 mA	300 mA
	7.5	7N5		250 mA	
	8.2	8N2	250 mA	250 mA	300 mA
	10	10N	250 mA	250 mA	300 mA
	12	12N	250 mA	250 mA	300 mA
	13	13N	250 mA	250 mA	
	15	15N	250 mA	250 mA	300 mA
	18	18N	200 mA	200 mA	300 mA
	20	20N	200 mA	200 mA	
	22	22N	200 mA	200 mA	300 mA
	23	23N		200 mA	
	27	27N	200 mA	200 mA	300 mA
	33	33N	200 mA	200 mA	300 mA
	39	39N	200 mA	150 mA	300 mA
	43	43N		150 mA	
	47	47N		150 mA	300 mA
	56	56N		150 mA	300 mA
	68	68N		100 mA	300 mA
	82	82N		100 mA	300 mA
	100	R10		100 mA	300 mA
	120	R12		100 mA	300 mA
	150	R15			300 mA
	180	R18			300 mA
	220	R22			300 mA
	270	R27			
	330	R33			
	390	R39			
	420	R42			
	560	R56			
	680	R68			

Consult factory for Non-Standard values. C tolerance are non-standard terms
See web page for Chip Inductor Product Detail Summary by part number

RF CHARACTERISTICS CHARACTERISTICS (TYPICAL)

INDUCTANCE VS FREQUENCY: SIZE 0201

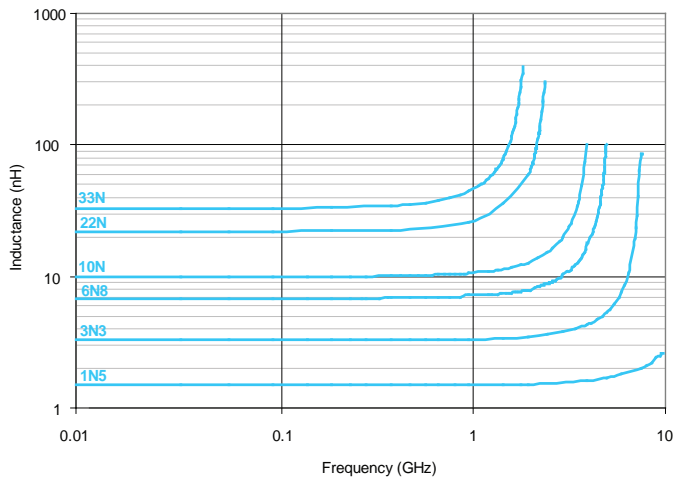

Q VS FREQUENCY: SIZE 0201

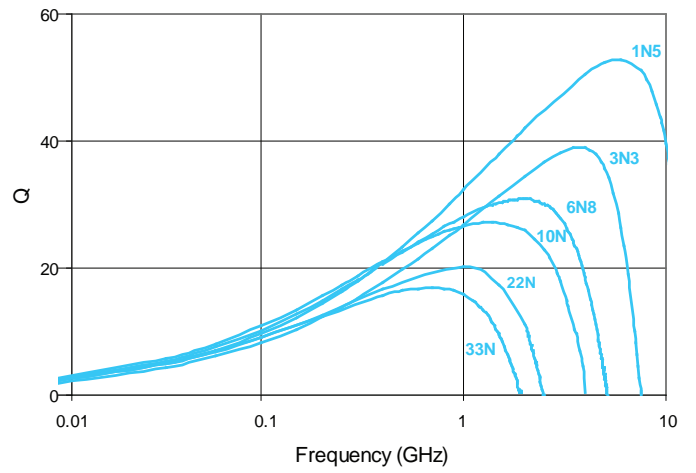

INDUCTANCE VS FREQUENCY: SIZE 0402

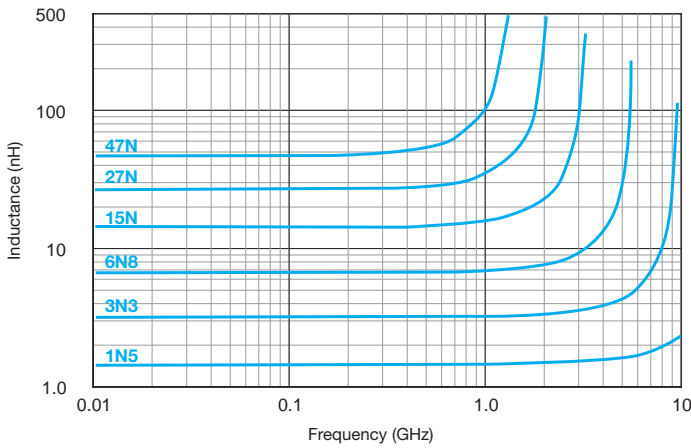

Q VS FREQUENCY: SIZE 0402

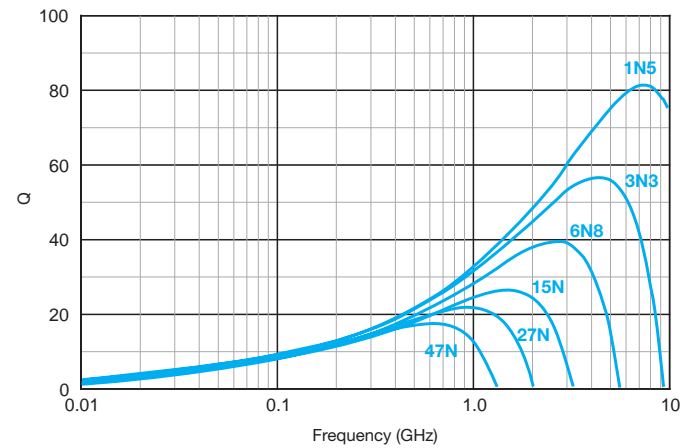

INDUCTANCE VS FREQUENCY: SIZE 0603

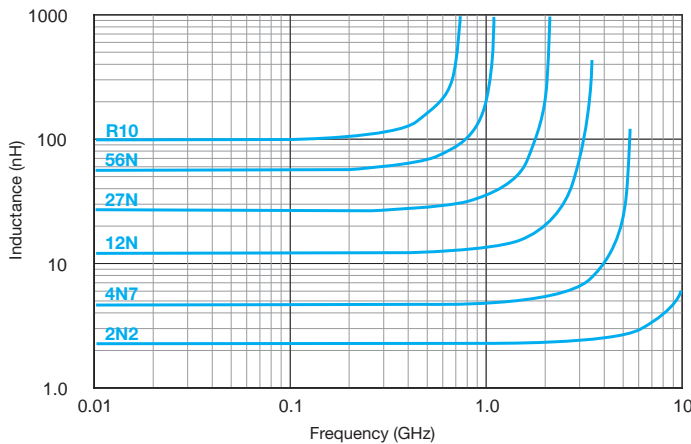

Q VS FREQUENCY: SIZE 0603

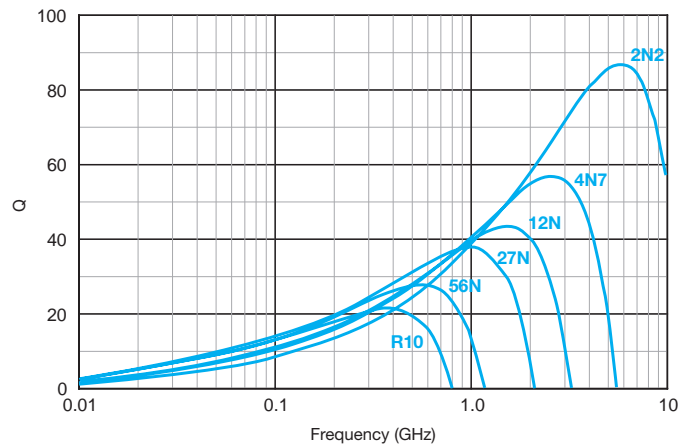

RF WIREWOUND CHIP INDUCTORS

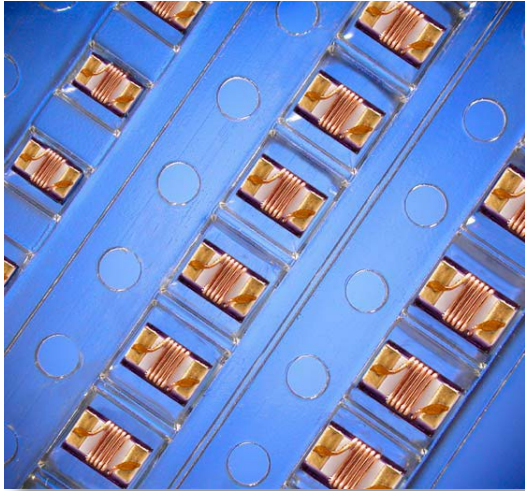

These high frequency High-Q chip inductors feature a monolithic body made of low loss ceramic wound with wire to achieve optimal high frequency performance.

These RF chip inductors are compact in size and are provided on tape and reel packaging which makes them ideal for high volume RF applications. They feature a nickel barrier with a top plating of gold for the ceramic core types (all 0402, all 0603, and most 0805 types), and with a top plating of 100% tin for the ferrite core types (0805 size, 470 nH and higher). Most inductance values between those listed are available on request.

APPLICATIONS

- CELL/PCS Modules
- Wireless LAN
- Broadband Components
- RFID
- RF Transceivers
- Cordless Phone
- Cable Modem
- Computer Peripherals
- Bluetooth
- ASDL

PRODUCT RANGE SUMMARY

EIA SIZE (mm)	SIZE CODE	L RANGE	Q FACTOR (Typ.)	SRF (Typ.)	TEMPERATURE
0402 (1005)	L-07	1.0 - 120 nH	55 (900 MHz)	>11 GHz (1.0 nH)	-40°C to + 125°C
0603 (1608)	L-14	2.0 - 470 nH	60 (900 MHz)	>13 GHz (2.0 nH)	-40°C to + 125°C
0805 (2012)	L-15	2.2 - 10,000 nH	60 (500 MHz)	>11 GHz (2.2 nH)	-40°C to + 125°C*

*-40 deg. C to +85 deg. C for ferrite core types

MECHANICAL CHARACTERISTICS

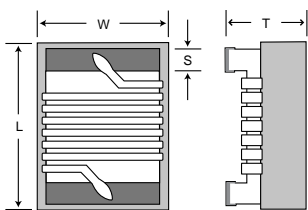

	0402 (1005)		0603 (1608)		0805 (2012)	
	Inches	mm	Inches	mm	Inches	mm
Length	.039 ±.004"	(1.00 ±.10)	.063 ±.008"	(1.60 ±.20)	.079 ±.008"	(2.00 ±.20)
Width	.022 ±.004"	(0.55 ±.10)	.041 ±.008"	(1.05 ±.20)	.049 ±.008"	(1.25 ±.20)
Thickness	.020 ±.004"	(0.50 ±.10)	.041 ±.008"	(1.05 ±.20)	.047 ±.008"	(1.20 ±.20)
End Band	.008 ±.004"	(0.20 ±.10)	.014 ±.004"	(0.35 ±.10)	.016 ±.004"	(0.40 ±.10)

HOW TO ORDER

L-	07	W	4N3	S	V	4	T																								
DEVICE	SIZE	TYPE	VALUE	TOLERANCE*	TERMINATION	MARKING	PACKAGING																								
Inductor	07 = 0402 14 = 0603 15 = 0805	W = Wirewound on Ceramic Core F = Wirewound on Ferrite Core	See Table	C = ± 0.2 nH S = ± 0.3 nH G = ± 2% J = ± 5% K = ± 10%	V = Ni / Au for "W" types, and V = Ni / 100% Sn for "F" types	4 = No Marking	Tape and Reel <table border="1"> <thead> <tr> <th>Size</th> <th>Code</th> <th>Tape</th> <th>Reel</th> <th>Qty</th> </tr> </thead> <tbody> <tr> <td>0402</td> <td>T</td> <td>Paper</td> <td>7"</td> <td>10,000</td> </tr> <tr> <td>0603</td> <td>E</td> <td>Embossed</td> <td>7"</td> <td>3,000</td> </tr> <tr> <td>0805</td> <td>E</td> <td>Embossed</td> <td>7"</td> <td>2,000</td> </tr> </tbody> </table> Bulk (Loose Pcs.) <table border="1"> <thead> <tr> <th>Size</th> <th>Code</th> </tr> </thead> <tbody> <tr> <td>All</td> <td>S</td> </tr> </tbody> </table>	Size	Code	Tape	Reel	Qty	0402	T	Paper	7"	10,000	0603	E	Embossed	7"	3,000	0805	E	Embossed	7"	2,000	Size	Code	All	S
Size	Code	Tape	Reel	Qty																											
0402	T	Paper	7"	10,000																											
0603	E	Embossed	7"	3,000																											
0805	E	Embossed	7"	2,000																											
Size	Code																														
All	S																														

Example Part Number:

L-07W4N3SV4T is: 0402 Wirewound, 4.3 nanohenry, +/- 0.3 nH tolerance, Ni / Au termination, No Marking, Paper tape on a 7" reel.



RF WIREWOUND CHIP INDUCTOR SELECTION CHART

EIA Size		0402 (L-07)		0603 (L-14)		0805 (L-15)		Core Type
Inductor Value	Inductance nH	Tolerance	Rated Current	Tolerance	Rated Current	Tolerance	Rated Current	
1.0	1N0	C, S	1360 mA					CERAMIC CORE ("V" Type)
1.2	1N2	C, S	1300 mA					
1.6	1N6			C, S	700 mA			
1.8	1N8	C, S	1040 mA	C, S	700 mA			
1.9	1N9	C, S	1040 mA					
2.0	2N0	C, S	1040 mA	C, S	700 mA			
2.2	2N2	C, S	960 mA			C, S	800 mA	
2.4	2N4	C, S	790 mA					
2.6	2N6	C, S	640 mA					
2.7	2N7	C, S	640 mA			C, S	800 mA	
3.3	3N3	C, J, K	840 mA	C, S	700 mA	C, S	800 mA	
3.6	3N6	C, J, K	840 mA	C, S	700 mA			
3.9	3N9	C, J, K	840 mA	C, S	700 mA	C, S	600 mA	
4.3	4N3	C, J, K	700 mA	C, S	700 mA			
4.7	4N7	C, J, K	640 mA	C, S	700 mA	C, S	600 mA	
5.1	5N1	C, J, K	800 mA	C, J, K	700 mA			
5.6	5N6	C, J, K	760 mA	C, J, K	700 mA	C, J, K	600 mA	
6.2	6N2	C, J, K	760 mA					
6.8	6N8	C, J, K	680 mA	C, J, K	700 mA	C, G, J, K	600 mA	
7.5	7N5	C, J, K	680 mA	C, J, K	700 mA	J, K	600 mA	
8.2	8N2	C, J, K	680 mA	C, J, K	700 mA	C, G, J, K	600 mA	
8.7	8N7	C, J, K	480 mA	C, J, K	700 mA			
9.0	9N0	C, J, K	680 mA					
9.5	9N5	C, J, K	680 mA	C, J, K	700 mA			
10	10N	G, J, K	480 mA	G, J, K	700 mA	G, J, K	600 mA	
11	11N	G, J, K	640 mA	G, J, K	700 mA			
12	12N	G, J, K	640 mA	G, J, K	700 mA	G, J, K	600 mA	
13	13N	G, J, K	560 mA			J, K	600 mA	
15	15N	G, J, K	560 mA	G, J, K	700 mA	G, J, K	600 mA	
16	16N	G, J, K	560 mA	G, J, K	700 mA	G, J, K	600 mA	
18	18N	G, J, K	420 mA	G, J, K	700 mA	G, J, K	600 mA	
19	19N	G, J, K	480 mA					
20	20N	G, J, K	420 mA	G, J, K	700 mA	G, J, K	600 mA	
22	22N	G, J, K	400 mA	G, J, K	700 mA	G, J, K	600 mA	
23	23N	G, J, K	400 mA	G, J, K	700 mA			
24	24N	G, J, K	400 mA	G, J, K	700 mA	J, K	600 mA	
27	27N	G, J, K	400 mA	G, J, K	600 mA	G, J, K	600 mA	
30	30N	G, J, K	400 mA	G, J, K	700 mA			
33	33N	G, J, K	400 mA	G, J, K	600 mA	G, J, K	500 mA	
36	36N	G, J, K	320 mA			J, K	600 mA	
39	39N	G, J, K	320 mA	G, J, K	600 mA	G, J, K	500 mA	
40	40N	G, J, K	320 mA					
43	43N	G, J, K	100 mA	G, J, K	700 mA	J, K	600 mA	
47	47N	G, J, K	100 mA	G, J, K	600 mA	G, J, K	500 mA	
51	51N	J, K	100 mA	G, J, K	600 mA	J, K	600 mA	
56	56N	J, K	100 mA	G, J, K	600 mA	G, J, K	500 mA	
68	68N	J, K	100 mA	G, J, K	600 mA	G, J, K	500 mA	
72	72N			G, J, K	400 mA			
82	82N	J, K	100 mA	G, J, K	400 mA	G, J, K	500 mA	
100	R10	J, K	100 mA	G, J, K	400 mA	G, J, K	500 mA	
110	R11	J, K	100 mA					
120	R12	J, K	100 mA	G, J, K	300 mA	G, J, K	500 mA	
150	R15			G, J, K	280 mA	G, J, K	400 mA	
180	R18			G, J, K	240 mA	G, J, K	400 mA	
220	R22			G, J, K	200 mA	G, J, K	400 mA	
270	R27			G, J, K	170 mA	G, J, K	350 mA	

EIA Size		0402 (L-07)		0603 (L-14)		0805 (L-15)		Core Type
Inductor Value	Inductance nH	Tolerance	Rated Current	Tolerance	Rated Current	Tolerance	Rated Current	
330	R33			J, K	150 mA	G, J, K	300 mA	Ceramic
390	R39			J, K	100 mA	G, J, K	210 mA	
470	R47			J, K	100 mA	J, K	500 mA	FERRITE CORE ("F" Type)
560	R56					J, K	450 mA	
680	R68					J, K	400 mA	
820	R82					J, K	300 mA	
1000	1R0					J, K	180 mA	
1200	1R2					J, K	150 mA	
1500	1R5					J, K	130 mA	
1800	1R8					J, K	120 mA	
2200	2R2					J, K	110 mA	
2700	2R7					J, K	100 mA	
3300	3R3					J, K	210 mA	
3900	3R9					J, K	200 mA	
4700	4R7					J, K	180 mA	
5600	5R6					J, K	160 mA	
6800	6R8					J, K	130 mA	
8200	8R2					J, K	120 mA	
10000	10R					J, K	80 mA	

Consult factory for Non-Standard values.

See web page for WireWound Inductor Product Detail Summary by part number

Q vs Frequency for 0402 Size

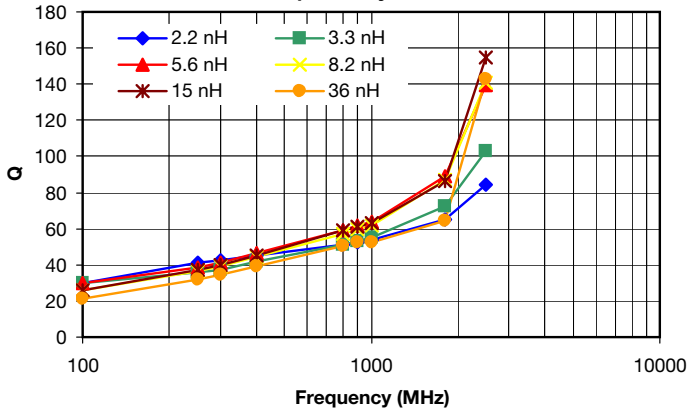

L vs Frequency for 0402 Size

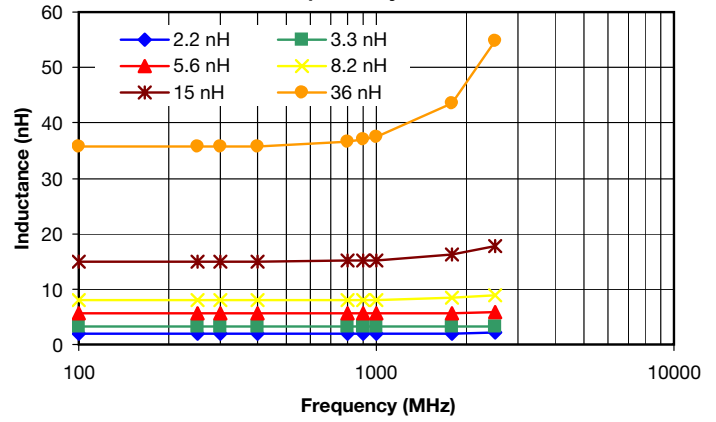

Q vs Frequency for 0603 Size

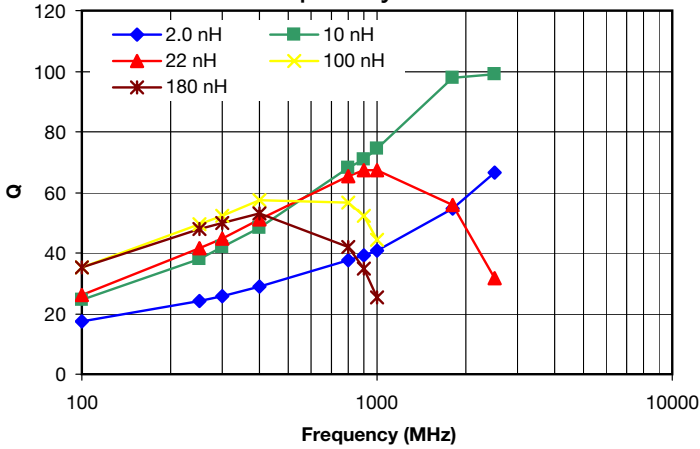

L vs Frequency for 0603 Size

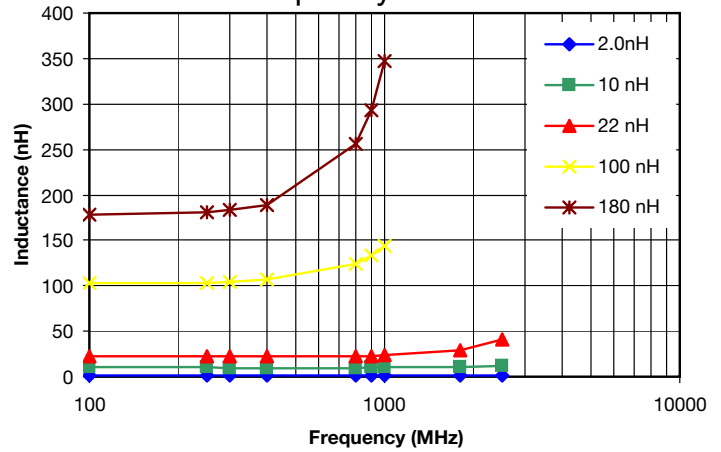

Q vs Frequency for 0805 Size

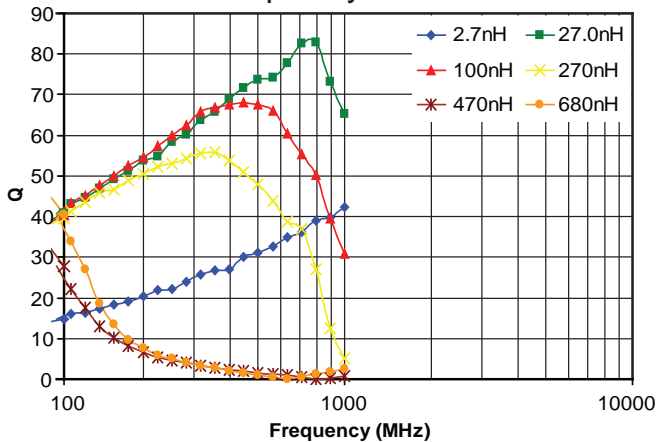

L vs Frequency for 0805 Size

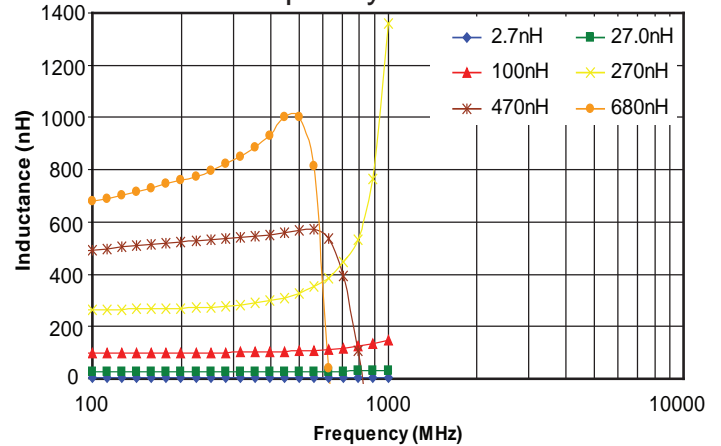

0402 INDUCTANCE RANGE / ELECTRICAL CHARACTERISTICS

Part Number (Standard Tol.)	Inductance @ 250MHz	Available Tolerances @ 250MHz	Q (min.) @ 250MHz	Q (Typ.) @ 900MHz	Q (Typ.) @ 1.8GHz	SRF (min.)	DC Resistance (max.)	Rated Current (max.)
L-07W1N0SV4T	1.0 nH	±0.2 nH, ±0.3 nH	13	49	60	6.0 GHz	0.045 Ω	1360 mA
L-07W1N2SV4T	1.2 nH	±0.2 nH, ±0.3 nH	13	49	60	6.0 GHz	0.060 Ω	1300 mA
L-07W1N8SV4T	1.8 nH	±0.2 nH, ±0.3 nH	16	50	60	6.0 GHz	0.070 Ω	1040 mA
L-07W1N9SV4T	1.9 nH	±0.2 nH, ±0.3 nH	16	50	60	6.0 GHz	0.070 Ω	1040 mA
L-07W2N0SV4T	2.0 nH	±0.2 nH, ±0.3 nH	16	51	62	6.0 GHz	0.070 Ω	1040 mA
L-07W2N2SV4T	2.2 nH	±0.2 nH, ±0.3 nH	18	52	65	6.0 GHz	0.070 Ω	960 mA
L-07W2N4SV4T	2.4 nH	±0.2 nH, ±0.3 nH	15	52	65	6.0 GHz	0.068 Ω	790 mA
L-07W2N7SV4T	2.7 nH	±0.2 nH, ±0.3 nH	16	50	65	6.0 GHz	0.120 Ω	640 mA
L-07W3N3JV4T	3.3 nH	±0.2 nH, ±5%, ±10%	19	53	72	6.0 GHz	0.066 Ω	840 mA
L-07W3N6JV4T	3.6 nH	±0.2 nH, ±5%, ±10%	19	55	72	6.0 GHz	0.066 Ω	840 mA
L-07W3N9JV4T	3.9 nH	±0.2 nH, ±5%, ±10%	19	60	76	5.8 GHz	0.066 Ω	840 mA
L-07W4N3JV4T	4.3 nH	±0.2 nH, ±5%, ±10%	18	55	82	6.0 GHz	0.091 Ω	700 mA
L-07W4N7JV4T	4.7 nH	±0.2 nH, ±5%, ±10%	15	55	82	4.8 GHz	0.130 Ω	640 mA
L-07W5N1JV4T	5.1 nH	±0.2 nH, ±5%, ±10%	20	58	83	5.8 GHz	0.083 Ω	800 mA
L-07W5N6JV4T	5.6 nH	±0.2 nH, ±5%, ±10%	20	61	89	5.8 GHz	0.083 Ω	760 mA
L-07W6N2JV4T	6.2 nH	±0.2 nH, ±5%, ±10%	20	57	80	5.8 GHz	0.083 Ω	760 mA
L-07W6N8JV4T	6.8 nH	±0.2 nH, ±5%, ±10%	20	58	80	4.8 GHz	0.083 Ω	680 mA
L-07W7N5JV4T	7.5 nH	±0.2 nH, ±5%, ±10%	22	59	90	5.8 GHz	0.104 Ω	680 mA
L-07W8N2JV4T	8.2 nH	±0.2 nH, ±5%, ±10%	22	60	87	4.4 GHz	0.104 Ω	680 mA
L-07W8N7JV4T	8.7 nH	±0.2 nH, ±5%, ±10%	18	60	83	4.1 GHz	0.200 Ω	480 mA
L-07W9N0JV4T	9.0 nH	±0.2 nH, ±5%, ±10%	22	60	83	4.2 GHz	0.104 Ω	680 mA
L-07W9N5JV4T	9.5 nH	±0.2 nH, ±5%, ±10%	18	55	76	4.0 GHz	0.200 Ω	680 mA
L-07W10NJV4T	10.0 nH	±2%, ±5%, ±10%	21	56	76	3.9 GHz	0.195 Ω	480 mA
L-07W11NJV4T	11.0 nH	±2%, ±5%, ±10%	24	61	86	3.7 GHz	0.120 Ω	640 mA
L-07W12NJV4T	12.0 nH	±2%, ±5%, ±10%	24	58	77	3.6 GHz	0.120 Ω	640 mA
L-07W13NJV4T	13.0 nH	±2%, ±5%, ±10%	24	60	77	3.5 GHz	0.210 Ω	560 mA
L-07W15NJV4T	15.0 nH	±2%, ±5%, ±10%	24	61	86	3.3 GHz	0.172 Ω	560 mA
L-07W16NJV4T	16.0 nH	±2%, ±5%, ±10%	24	58	77	3.1 GHz	0.220 Ω	560 mA
L-07W18NJV4T	18.0 nH	±2%, ±5%, ±10%	24	58	77	3.1 GHz	0.230 Ω	420 mA
L-07W19NJV4T	19.0 nH	±2%, ±5%, ±10%	24	58	77	3.0 GHz	0.202 Ω	480 mA
L-07W20NJV4T	20.0 nH	±2%, ±5%, ±10%	24	54	74	3.0 GHz	0.250 Ω	420 mA
L-07W22NJV4T	22.0 nH	±2%, ±5%, ±10%	24	54	73	2.7 GHz	0.300 Ω	400 mA
L-07W23NJV4T	23.0 nH	±2%, ±5%, ±10%	24	55	73	2.7 GHz	0.214 Ω	400 mA
L-07W24NJV4T	24.0 nH	±2%, ±5%, ±10%	24	54	74	2.7 GHz	0.300 Ω	400 mA
L-07W27NJV4T	27.0 nH	±2%, ±5%, ±10%	24	55	75	2.5 GHz	0.298 Ω	400 mA
L-07W30NJV4T	30.0 nH	±2%, ±5%, ±10%	24	52	64	2.3 GHz	0.300 Ω	400 mA
L-07W33NJV4T	33.0 nH	±2%, ±5%, ±10%	24	52	64	2.3 GHz	0.350 Ω	400 mA
L-07W36NJV4T	36.0 nH	±2%, ±5%, ±10%	24	52	64	2.3 GHz	0.403 Ω	320 mA
L-07W39NJV4T	39.0 nH	±2%, ±5%, ±10%	24	51	48	2.1 GHz	0.550 Ω	320 mA
L-07W40NJV4T	40.0 nH	±2%, ±5%, ±10%	24	51	48	2.3 GHz	0.438 Ω	320 mA
L-07W43NJV4T	43.0 nH	±2%, ±5%, ±10%	24	50	46	2.0 GHz	0.810 Ω	100 mA
L-07W47NJV4T	47.0 nH	±2%, ±5%, ±10%	22@200MHz	50	46	2.1 GHz	0.830 Ω	100 mA
L-07W51NJV4T	51.0 nH	+/-5%, +/-10%	22@200MHz	49	N/A	1.7 GHz	0.820 Ω	100 mA
L-07W56NJV4T	56.0 nH	+/-5%, +/-10%	22@200MHz	49	N/A	1.7 GHz	0.970 Ω	100 mA
L-07W68NJV4T	68.0 nH	+/-5%, +/-10%	22@200MHz	42	N/A	1.6 GHz	1.120 Ω	100 mA



0402 INDUCTANCE RANGE / ELECTRICAL CHARACTERISTICS

Part Number (Standard Tol.)	Inductance @ 250MHz	Available Tolerances @ 250MHz	Q (min.) @ 250MHz	Q (Typ.) @ 900MHz	Q (Typ.) @ 1.8GHz	SRF (min.)	DC Resistance (max.)	Rated Current (max.)
L-07W82NJV4T	82.0 nH	+/-5%, +/-10%	16@150 MHz	39	N/A	1.5 GHz	1.250 Ω	100 mA
L-07WR10JV4T	100.0 nH	+/-5%, +/-10%	16@150 MHz	36	N/A	1.3 GHz	2.520 Ω	100 mA
L-07WR11JV4T	110.0 nH	+/-5%, +/-10%	14@150 MHz	35	N/A	1.2 GHz	2.660 Ω	100 mA
L-07WR12JV4T	120.0 nH	+/-5%, +/-10%	14@150 MHz	35	N/A	1.1 GHz	2.660 Ω	100 mA

0603 INDUCTANCE RANGE / ELECTRICAL CHARACTERISTICS

Part Number (Standard Tol.)	Inductance @ L/Q Freq.	L/Q Test Freq.	Available Tolerances @ L/Q Freq.	Q (min.) @ L/Q Freq.	SRF (min.)	DC Resistance (max.)	Rated Current (max.)
L-14W1N6SV4E	1.6 nH	250 MHz	± 0.2 nH, ± 0.3 nH	14	7.0 GHz	0.080 Ω	700 mA
L-14W1N8SV4E	1.8 nH	250 MHz	± 0.2 nH, ± 0.3 nH	16	6.9 GHz	0.080 Ω	700 mA
L-14W2N0SV4E	2.0 nH	250 MHz	± 0.2 nH, ± 0.3 nH	16	6.9 GHz	0.080 Ω	700 mA
L-14W3N3SV4E	3.3 nH	250 MHz	± 0.2 nH, ± 0.3 nH	17	6.1 GHz	0.080 Ω	700 mA
L-14W3N6SV4E	3.6 nH	250 MHz	± 0.2 nH, ± 0.3 nH	20	6.0 GHz	0.080 Ω	700 mA
L-14W3N9SV4E	3.9 nH	250 MHz	± 0.2 nH, ± 0.3 nH	22	5.9 GHz	0.080 Ω	700 mA
L-14W4N3SV4E	4.3 nH	250 MHz	± 0.2 nH, ± 0.3 nH	22	5.8 GHz	0.060 Ω	700 mA
L-14W4N7SV4E	4.7 nH	250 MHz	± 0.2 nH, ± 0.3 nH	20	5.8 GHz	0.110 Ω	700 mA
L-14W5N1JV4E	5.1 nH	250 MHz	± 0.2 nH, $\pm 5\%$, $\pm 10\%$	18	5.4 GHz	0.110 Ω	700 mA
L-14W5N6JV4E	5.6 nH	250 MHz	± 0.2 nH, $\pm 5\%$, $\pm 10\%$	16	5.0 GHz	0.110 Ω	700 mA
L-14W6N8JV4E	6.8 nH	250 MHz	± 0.2 nH, $\pm 5\%$, $\pm 10\%$	30	4.6 GHz	0.110 Ω	700 mA
L-14W7R5JV4E	7.5 nH	250 MHz	± 0.2 nH, $\pm 5\%$, $\pm 10\%$	30	4.7 GHz	0.110 Ω	700 mA
L-14W8N2JV4E	8.2 nH	250 MHz	± 0.2 nH, $\pm 5\%$, $\pm 10\%$	30	4.8 GHz	0.100 Ω	700 mA
L-14W8N7JV4E	8.7 nH	250 MHz	± 0.2 nH, $\pm 5\%$, $\pm 10\%$	30	4.6 GHz	0.120 Ω	700 mA
L-14W10NJV4E	10.0 nH	250 MHz	$\pm 2\%$, $\pm 5\%$, $\pm 10\%$	31	4.0 GHz	0.130 Ω	700 mA
L-14W11NJV4E	11.0 nH	250 MHz	$\pm 2\%$, $\pm 5\%$, $\pm 10\%$	33	4.0 GHz	0.086 Ω	700 mA
L-14W12NJV4E	12.0 nH	250 MHz	$\pm 2\%$, $\pm 5\%$, $\pm 10\%$	35	4.0 GHz	0.130 Ω	700 mA
L-14W15NJV4E	15.0 nH	250 MHz	$\pm 2\%$, $\pm 5\%$, $\pm 10\%$	35	3.1 GHz	0.170 Ω	700 mA
L-14W18NJV4E	18.0 nH	250 MHz	$\pm 2\%$, $\pm 5\%$, $\pm 10\%$	38	3.0 GHz	0.170 Ω	700 mA
L-14W22NJV4E	22.0 nH	250 MHz	$\pm 2\%$, $\pm 5\%$, $\pm 10\%$	38	3.0 GHz	0.220 Ω	700 mA
L-14W27NJV4E	27.0 nH	250 MHz	$\pm 2\%$, $\pm 5\%$, $\pm 10\%$	40	2.8 GHz	0.220 Ω	600 mA
L-14W33NJV4E	33.0 nH	250 MHz	$\pm 2\%$, $\pm 5\%$, $\pm 10\%$	43	2.3 GHz	0.220 Ω	600 mA
L-14W39NJV4E	39.0 nH	250 MHz	$\pm 2\%$, $\pm 5\%$, $\pm 10\%$	43	2.2 GHz	0.250 Ω	600 mA
L-14W47NJV4E	47.0 nH	200 MHz	$\pm 2\%$, $\pm 5\%$, $\pm 10\%$	40	2.0 GHz	0.280 Ω	600 mA
L-14W51NJV4E	51.0 nH	200 MHz	$\pm 2\%$, $\pm 5\%$, $\pm 10\%$	40	1.9 GHz	0.300 Ω	600 mA
L-14W56NJV4E	56.0 nH	200 MHz	$\pm 2\%$, $\pm 5\%$, $\pm 10\%$	40	1.9 GHz	0.310 Ω	600 mA
L-14W68NJV4E	68.0 nH	200 MHz	$\pm 2\%$, $\pm 5\%$, $\pm 10\%$	40	1.7 GHz	0.340 Ω	600 mA
L-14W72NJV4E	72.0 nH	150 MHz	$\pm 2\%$, $\pm 5\%$, $\pm 10\%$	35	1.7 GHz	0.490 Ω	400 mA
L-14W82NJV4E	82.0 nH	150 MHz	$\pm 2\%$, $\pm 5\%$, $\pm 10\%$	35	1.7 GHz	0.540 Ω	400 mA
L-14WR10JV4E	100.0 nH	150 MHz	$\pm 2\%$, $\pm 5\%$, $\pm 10\%$	35	1.4 GHz	0.630 Ω	400 mA
L-14WR12JV4E	120.0 nH	150 MHz	$\pm 2\%$, $\pm 5\%$, $\pm 10\%$	35	1.3 GHz	0.650 Ω	300 mA
L-14WR15JV4E	150.0 nH	150.0 nH	$\pm 2\%$, $\pm 5\%$, $\pm 10\%$	35	1.0 GHz	0.920 Ω	280 mA
L-14WR18JV4E	180.0 nH	100 MHz	$\pm 2\%$, $\pm 5\%$, $\pm 10\%$	30	1.0 GHz	1.25 Ω	240 mA
L-14WR22JV4E	220.0 nH	100 MHz	$\pm 2\%$, $\pm 5\%$, $\pm 10\%$	30	1.0 GHz	1.70 Ω	200 mA
L-14WR27JV4E	270.0 nH	100 MHz	$\pm 2\%$, $\pm 5\%$, $\pm 10\%$	30	1.0 GHz	1.80 Ω	170 mA
L-14WR33JV4E	330.0 nH	100 MHz	$\pm 5\%$, $\pm 10\%$	25	900 MHz	3.60 Ω	150 mA
L-14WR39JV4E	390.0 nH	100 MHz	$\pm 5\%$, $\pm 10\%$	24	750 MHz	5.30 Ω	100 mA
L-14WR47JV4E	470.0 nH	100 MHz	$\pm 5\%$, $\pm 10\%$	23	700 MHz	5.60 Ω	100 mA

0805 INDUCTANCE RANGE / ELECTRICAL CHARACTERISTICS

Part Number (Standard Tol.)	Inductance @ L Test Freq.	L Test Freq.	Available Tolerances @ L Test Freq.	Q (min.) @ Q Test Freq.	Q Test Freq.	SRF (min.)	DC Resistance (max.)	Rated Current (max.)
L-15W2N2SV4E	2.2 nH	250 MHz	±0.2 nH, ±0.3 nH	50	1000 MHz	>6000 MHz	0.06 Ω	800 mA
L-15W2N7SV4E	2.7 nH	250 MHz	±0.2 nH, ±0.3 nH	30	1000 MHz	>6000 MHz	0.08 Ω	800 mA
L-15W3N3SV4E	3.3 nH	250 MHz	±0.2 nH, ±0.3 nH	60	1000 MHz	>6000 MHz	0.08 Ω	800 mA
L-15W3N9SV4E	3.9 nH	250 MHz	±0.2 nH, ±0.3 nH	60	1000 MHz	>6000 MHz	0.06 Ω	600 mA
L-15W4N7SV4E	4.7 nH	250 MHz	±0.2 nH, ±0.3 nH	60	1000 MHz	5800 MHz	0.06 Ω	600 mA
L-15W5N6SV4E	5.6 nH	250 MHz	±0.2 nH, ±5%, ±10%	60	1000 MHz	5800 MHz	0.08 Ω	600 mA
L-15W6N8SV4E	6.8 nH	250 MHz	±0.2 nH, ±5%, ±10%	60	1000 MHz	5500 MHz	0.06 Ω	600 mA
L-15W8N2SV4E	8.2 nH	250 MHz	±0.2 nH, ±5%, ±10%	60	1000 MHz	5500 MHzzz	0.06 Ω	600 mA
L-15W10NJV4E	10.0 nH	250 MHz	±2%, ±5%, ±10%	60	500 MHz	4800 MHz	0.08 Ω	600 mA
L-15W12NJV4E	12.0 nH	250 MHz	±2%, ±5%, ±10%	60	500 MHz	4100 MHz	0.08 Ω	600 mA
L-15W15NJV4E	15.0 nH	250 MHz	±2%, ±5%, ±10%	60	500 MHz	3600 MHz	0.08 Ω	600 mA
L-15W16NJV4E	16.0 nH	250 MHz	±2%, ±5%, ±10%	60	500 MHz	3500 MHz	0.08 Ω	600 mA
L-15W18NJV4E	18.0 nH	250 MHz	±2%, ±5%, ±10%	60	500 MHz	3400 MHz	0.08 Ω	600 mA
L-15W20NJV4E	20.0 nH	250 MHz	±2%, ±5%, ±10%	60	500 MHz	3400 MHz	0.08 Ω	600 mA
L-15W22NJV4E	22.0 nH	250 MHz	±2%, ±5%, ±10%	60	500 MHz	3300 MHz	0.10 Ω	600 mA
L-15W27NJV4E	27.0 nH	250 MHz	±2%, ±5%, ±10%	60	500 MHz	2600 MHz	0.12 Ω	600 mA
L-15W33NJV4E	33.0 nH	250 MHz	±2%, ±5%, ±10%	60	500 MHz	2400 MHz	0.15 Ω	500 mA
L-15W39NJV4E	39.0 nH	250 MHz	±2%, ±5%, ±10%	60	500 MHz	2100 MHz	0.18 Ω	500 mA
L-15W47NJV4E	47.0 nH	200 MHz	±2%, ±5%, ±10%	60	500 MHz	1700 MHz	0.15 Ω	500 mA
L-15W56NJV4E	56.0 nH	200 MHz	±2%, ±5%, ±10%	60	500 MHz	1600 MHz	0.25 Ω	500 mA
L-15W68NJV4E	68.0 nH	150 MHz	±2%, ±5%, ±10%	60	500 MHz	1450 MHz	0.27 Ω	500 mA
L-15W82NJV4E	82.0 nH	150 MHz	±2%, ±5%, ±10%	60	500 MHz	1350 MHz	0.32 Ω	500 mA
L-15WR10JV4E	100 nH	100 MHz	±2%, ±5%, ±10%	57	250 MHz	1200 MHz	0.43 Ω	500 mA
L-15WR12JV4E	120 nH	100 MHz	±2%, ±5%, ±10%	50	250 MHz	1100 MHz	0.48 Ω	500 mA
L-15WR15JV4E	150 nH	100 MHz	±2%, ±5%, ±10%	50	250 MHz	950 MHz	0.56 Ω	400 mA
L-15WR18JV4E	180 nH	100 MHz	±2%, ±5%, ±10%	50	250 MHz	900 MHz	0.78 Ω	400 mA
L-15WR22JV4E	220 nH	100 MHz	±2%, ±5%, ±10%	50	250 MHz	860 MHz	1.00 Ω	400 mA
L-15WR27JV4E	270 nH	100 MHz	±2%, ±5%, ±10%	45	250 MHz	850 MHz	1.46 Ω	350 mA
L-15WR33JV4E	330 nH	25 MHz	±2%, ±5%, ±10%	45	250 MHz	800 MHz	1.65 Ω	300 mA
L-15WR39JV4E	390 nH	25 MHz	±2%, ±5%, ±10%	45	250 MHz	780 MHz	2.20 Ω	210 mA
L-15FR47JV4E	470 nH	25 MHz	±5%, ±10%	45	100 MHz	375 MHz	0.95 Ω	500 mA
L-15FR56JV4E	560 nH	25 MHz	±5%, ±10%	45	100 MHz	340 MHz	1.10 Ω	450 mA
L-15FR68JV4E	680 nH	25 MHz	±5%, ±10%	35	100 MHz	188 MHz	1.20 Ω	400 mA
L-15FR82JV4E	820 nH	8 MHz	±5%, ±10%	35	100 MHz	210 MHz	1.50 Ω	300 mA
L-15F1R0JV4E	1000 nH	8 MHz	±5%, ±10%	35	50 MHz	200 MHz	2.13 Ω	180 mA
L-15F1R2JV4E	1200 nH	8 MHz	±5%, ±10%	15	8 MHz	200 MHz	2.38 Ω	150 mA
L-15F1R5JV4E	1500 nH	8 MHz	±5%, ±10%	15	8 MHz	200 MHz	2.90 Ω	130 mA
L-15F1R8JV4E	1800 nH	8 MHz	±5%, ±10%	15	8 MHz	120 MHz	3.00 Ω	120 mA
L-15F2R2JV4E	2200 nH	8 MHz	±5%, ±10%	15	8 MHz	110 MHz	3.10 Ω	110 mA
L-15F2R7JV4E	2700 nH	8 MHz	±5%, ±10%	15	8 MHz	100 MHz	3.50 Ω	100 mA
L-15F3R3JV4E	3300 nH	8 MHz	±5%, ±10%	15	8 MHz	70 MHz	2.30 Ω	210 mA
L-15F3R9JV4E	3900 nH	8 MHz	±5%, ±10%	15	8 MHz	60 MHz	2.50 Ω	200 mA
L-15F4R7JV4E	4700 nH	8 MHz	±5%, ±10%	15	8 MHz	50 MHz	2.80 Ω	180 mA
L-15F5R6JV4E	5600 nH	8 MHz	±5%, ±10%	15	8 MHz	45 MHz	3.00 Ω	160 mA
L-15F6R8JV4E	6800 nH	8 MHz	±5%, ±10%	15	8 MHz	45 MHz	3.20 Ω	130 mA
L-15F8R2JV4E	8200 nH	8 MHz	±5%, ±10%	15	8 MHz	40 MHz	3.50 Ω	120 mA
L-15F10RJV4E	10000 nH	8 MHz	±5%, ±10%	10	8 MHz	40 MHz	5.00 Ω	80 mA

INTEGRATED PASSIVE COMPONENTS

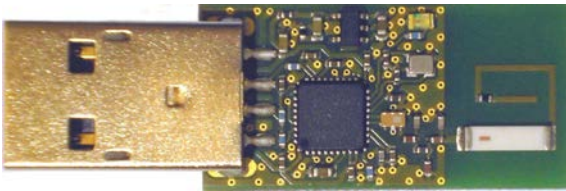
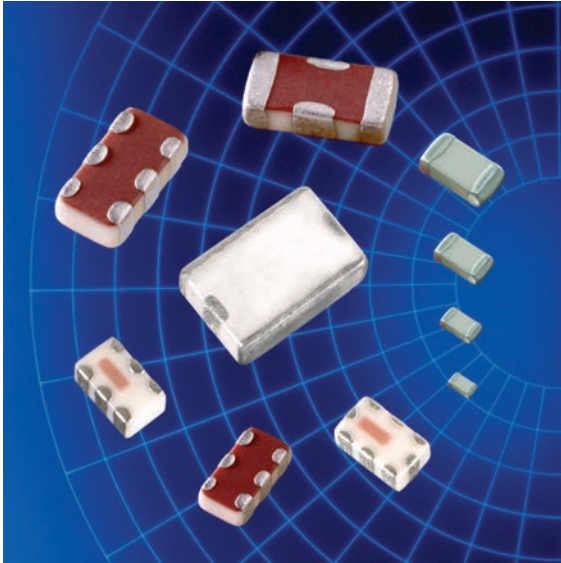

Johanson Technology has developed a line of small, highly reliable RF ceramic components manufactured with a proprietary LTCC (low temperature co-fired ceramic) process. These components operate over several bands from 900MHz to 6 GHz covering Cellular, DECT, WLAN, Bluetooth, 802.11 (a,b and g) and GPS applications.

In addition to the array of listed components we can support custom solutions for high volume applications with design flexibility and short development times. Contact us today with your specific technical requirements.

KEY FEATURES

- Custom Solutions
- LTCC Based Designs
- Low Insertion Loss
- Miniature Size / Low Profile
- Temperature Stable
- Surface Mount
- RoHS Compliant, Standard, Use No Suffix
- Tin / Lead Term. Option, Add "/Pb" Suffix

SUPPORTED APPLICATION BANDS

- Wireless LAN, Bluetooth, Home RF
- GSM/EDGE/GPRS/DCS/PCS/WCDMA
- WiMAX 802.16 d/e
- 2.4 GHz & 5.5 GHz ISM Band
- Zigbee
- MIMO
- GPS
- UNII
- UWB

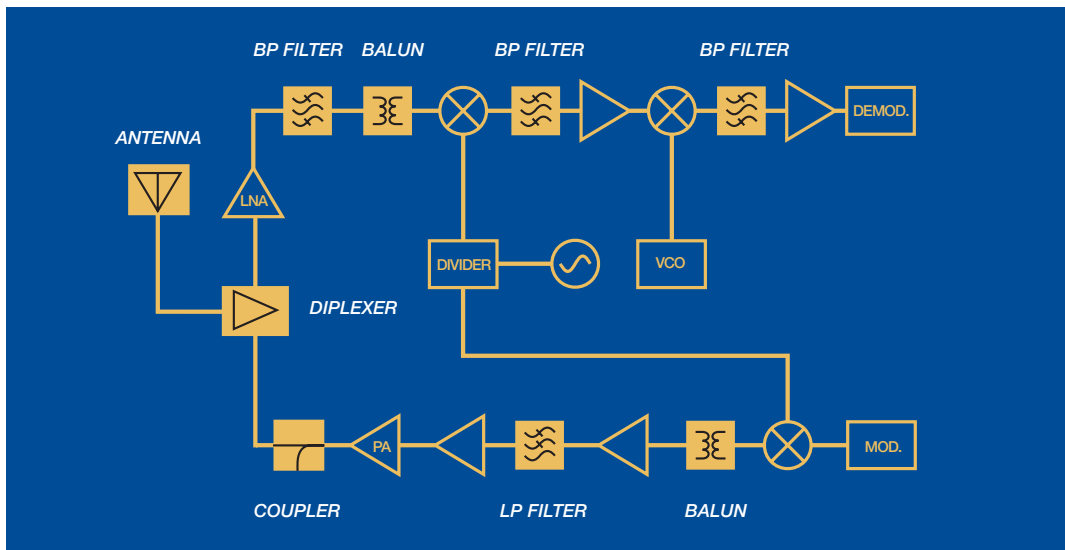

CERAMIC CHIP ANTENNAS

Part Number	Frequency (MHz)	Peak Gain	Ave. Gain	Return Loss (min)	Case Size
0433AT62A0020	423 - 443	-4 dBi typ. (XZ-total)	-4 dBi typ. (XZ-total)	9.5 dB	See Spec Sheet
0783AT43A0008	779 - 787	-2.0 dBi typ. (XZ-total)	-5.0 dBi typ. (XZ-total)	9.5 dB	43-1
0868AT43A0020	858 - 878	-1.0 dBi typ (XZ-total)	-4.0 dBi typ (XZ-total)	9.5 dB	43-1
0920AT50A080	880 - 960	-0.7 dBi typ (XZ-V)	-2.6 dBi typ (XZ-V)	8.5 dB	50
0915AT43A0026	902 - 928	-1.0 dBi typ (XZ-total)	-4.0 dBi typ (XZ-total)	8.5 dB	43-1
0953AT43A0006	950 - 956	-1.0 dBi typ.(XZ-total)	-1.0 dBi typ.(XZ-total)	9.5 dB	43-1
1575AM55B0001	1575.42 ± 5 MHz	1.3 dBi typ (YZ-total)	-0.7 dBi typ (YZ-total)	9.5 dB	See Spec Sheet
1575AT43A0040	1555 - 1595	- 1.5 dBi typ (XZ-V)	-2.5 dBi typ (XZ-V)	9.5 dB	43-1
1575AT47A0040	1555 - 1595	-1.0 dBi typ (XZ-V)	-3.0 dBi typ (XZ-V)	9.5 dB	47-1
1575AT54A0010	1570 - 1580	1.3 dBi typ (YZ-Total)	-0.7 dBi typ (YZ-Total)	9.5 dB	See Spec Sheet
1600AT45A0040	1580 - 1620	0.0 dBi typ (XZ-Total)	-1.0 dBi typ (XZ-Total)	9.5 dB	45-1
2000AT18A0075	1965 - 2040	0.3 dBi typ (XZ-V)	-3 dBi typ (XZ-V)	9.5 dB	18-4
2450AT18A100	2400 - 2500	0.5 dBi typ (XZ-V)	-0.5 dBi typ (XZ-V)	9.5 dB	18-4
2450AT18A0150	2375 - 2525	0.5 dBi typ (XZ-V)	-0.5 dBi typ (XZ-V)	9.5 dB	18-4
2450AT18B100	2400 - 2500	0.5 dBi typ (XZ-V)	-0.5 dBi typ (XZ-V)	9.5 dB	18-4
2450AT18D0100	2400 - 2500	1.5 dBi typ.(XZ-V)	-1.0 dBi typ.(XZ-V)	6.0 dB	18-5
2450AT42A100	2400 - 2500	0 dBi typ (XZ-V)	-1 dBi typ (XZ-V)	9.5 dB	42-1
2450AT42B100	2400 - 2500	0 dBi typ (XZ-V)	-1.5 dBi typ (XZ-V)	9.5 dB	42-1
2450AT42D0100	2400 - 2500	0.5 dBi typ (XZ-total)	-2.0 dBi typ (XZ-V)	6.0 dB	42-1
2450AT43A100	2400 - 2500	2.0 dBi typ (XZ-V)	0.5 dBi typ (XZ-V)	9.5 dB	43-1
2450AT43B100	2400 - 2500	1.3 dBi typ (XZ-V)	-0.5 dBi typ (XZ-V)	9.5 dB	43-2
2450AT43F0100	2400 - 2500	2.1 dBi typ (XZ-total)	1.0 dBi typ (XZ-total)	---	See Spec Sheet
2450AT43H0100	2400 - 2500	2.1 dBi typ. (XZ-V)	1.0 dBi typ. (XZ-V)	9.5 dB	See Spec Sheet
2450AT45A100	2400 - 2500	3.0 dBi typ (XZ-V)	1.0 dBi typ (XZ-V)	9.5 dB	45-1
2450AD46A5400 (Dual Band)	LB: 2400 - 2500 HB: 4900 - 5900	1.0 dBi typ (XZ-V) -1.5 dBi typ (XZ-V)	-2.5 dBi typ (YZ-V) -2.5 dBi typ (YZ-V)	8.5 dB 8.5 dB	46-1
2500AT43A0100	2450 - 2550	0.6 dBi typ (YZ-total)	-2.1 dBi typ (XZ-total)	3.0 dB	43-1
2500AT44M0400	2300 - 2700	2.5 dBi typ	0.5 dBi typ	9.5 dB	44-2
2600AT44A0600	2300 - 2900	2.0 dBi	0.0 dBi typ.	9.5 dB	42-2
2650AT43A0100	2600 - 2700	0.5 dBi typ (YZ-total)	-1.7 dBi typ (XZ-total)	3.0 dB	50
3100AT51A7200	3100 - 10300	1.5 dBi typ	-3.5 dBi typ	9.5 dB	51-1
4000AT44A1800	3100 - 4900	2.7 dBi typ	-3.5 dBi typ	7.4 dB	See Spec Sheet
5250AT43A200	5150 - 5350	3.6 dBi typ (XZ-V)	-2.3 dBi typ (XZ-V)	9.5 dB	43-1
5400AT18A1000	4900 - 5900	2.0 dBi typ (XZ-V)	-2.5 dBi typ (XZ-V)	8.5 dB	18-4
5500AT18A0725	5150 - 5875	2.0 dBi typ. (XZ-V)	-2.5 dBi typ. (XZ-V)	9.5 dB	18-4
5500AT07A0900	5725 - 5825	3.9 dBi typ (XZ-V)	-1.5 dBi typ (XZ-V)	9.5 dB	43-1

Basic case size drawings for above part numbers are located on pages 39-40.

Detailed specifications and performance curves for the RF Ceramic Component line are located on our website.

BAND-PASS FILTERS: 2.45 GHz

Part Number	Frequency (MHz)	Insertion Loss (max.)	Attenuation (min)	Return Loss (min)	Case Size (EIA)
2450BP07A0100	2400 - 2500	2.5 dB	25 dB @ 824 - 960 MHz 25 dB @ 1710 - 1910 MHz 25 dB @ 4800 - 5000 MHz 15 dB @ 7200 - 7500 MHz	9.5 dB	0402
2450BP14D0100	2400 - 2500	1.7 dB	30 dB @ 880 - 915 MHz 30 dB @ 1710 - 1785 MHz 25 dB @ 1850 - 1910 MHz 25 dB @ 4800 - 5000 MHz 15 dB @ 7200 - 7500 MHz	9.5 dB	0603
2450BP14E0100	2400 - 2500	2.5 dB	35 dB @ 824 - 960 MHz 38 dB @ 1710 - 1910 MHz 25 dB @ 4800 - 5000 MHz 20 dB @ 7200 - 7500 MHz	9.5 dB	0603
2450BP15B100	2400 - 2500	2.2 dB	25 @ 1200 - 1300 MHz 10 @ 2000 MHz 12 @ 3000 MHz 30 @ 3600 - 3800 MHz 34 @ 4800 - 5000 MHz	9.5 dB	0805
2450BP15C100	2400 - 2500	2.2 dB	30 dB @ 1200 - 1300 MHz 15 dB @ 2000 MHz 25 dB @ 3000 MHz 20 dB @ 3600 - 3800 MHz 20 dB @ 4800 - 5000 MHz	9.5 dB	0805
2450BP15D100	2400 - 2500	2.6 dB	30 dB @ 880 - 1990 MHz 20 dB @ 2110 - 2170 MHz 30 dB @ 4800 - 5000 MHz 20 dB @ 7200 - 7500 MHz	9.5 dB	0805
2450BP15E0100	2400 - 2500	1.5 dB	30 dB @ 880 - 915 MHz 30 dB @ 1710 - 1785 MHz 25 dB @ 1850 - 1910 MHz 25 dB @ 4800 - 5000 MHz 15 dB @ 7200 - 7500 MHz	9.5 dB	0805
2450BP15F0100	2400 - 2500	2.5 dB	35 dB @ 824 - 960 MHz 38 dB @ 1710 - 1910 MHz 25 dB @ 4800 - 5000 MHz 20 dB @ 7200 - 7500 MHz	9.5 dB	0805
2450BP15G0100	2400 - 2500	2.0 dB	30 dB @ 824 - 960 MHz 28 dB @ 1710 - 1910 MHz 20 dB @ 1910 - 1990 MHz 30 dB @ 4800 - 5000 MHz 20 dB @ 7200 - 7500 MHz	9.5 dB	0805
2450BP15H0100	2400 - 2500	1.5 max. @ 25°C 1.8 max. @ -40 - 85°C	25 dB @ 1200 - 1300 MHz 10 dB @ 2000 MHz 12 dB @ 3000 MHz 30 dB @ 3600 - 3800 MHz 34 dB @ 4800 - 5000 MHz	9.5 dB	0805

Basic case size drawings for above part numbers are located on pages 39-40.

Detailed specifications and performance curves for the RF Ceramic Component line are located on our website.

BAND-PASS FILTERS: 2.45 GHZ

Part Number	Frequency (MHz)	Insertion Loss (max.)	Attenuation (min)	Return Loss (min)	Case Size (EIA)
2450BP18C100E	2400 - 2500	2.5 dB	40 dB @ 1200 - 1800 MHz 25 dB @ 2100 MHz 35 dB @ 4800 - 5000 MHz 25 dB @ 7200 - 7500 MHz	9.5 dB	1206
2450BP39C100A	2400 - 2500	2.5 dB	42 dB @ 1710 - 1990 MHz 30 dB @ 2100 MHz 30 dB @ 4800 - 5000 MHz	9.5 dB	2520
2450BP39C100B	2400 - 2500	1.8 dB	30 dB @ 1710 - 1780 MHz 25 dB @ 1850 - 1910 MHz 25 dB @ 4800 - 5000 MHz	9.5 dB	2520
2450BP39C100C	2400 - 2500	1.5 dB	30 dB @ 800 - 915 MHz 30 dB @ 1710 - 1785 MHz 25 dB @ 1850 - 1910 MHz 25 dB @ 4800 - 5000 MHz 15 dB @ 7200 - 7500 MHz	9.5 dB	2520
2450BP39C100D	2450 ± 50	2.2 dB	30 dB @ 880 - 915MHz 30 dB @ 1710 - 1785MHz 25 dB @ 1850 - 1910MHz 25 dB @ 2100MHz 25 dB @ 4800 - 5000MHz 15 dB @ 7200 - 7500MHz	9.5 dB	2520
2450BP39D100B	2400 - 2500	2.5 dB	35 dB @ 880 - 915 MHz 18 dB @ 1710 - 1990 MHz 12 dB @ 2100 MHz 35 dB @ 3200 MHz 22 dB @ 4800 - 5000 MHz 22 dB @ 7200 - 7500 MHz	9.5 dB	2520
2450BP39D100C	2400 - 2500	1.2 dB	30 dB @ 880 - 915 MHz 30 dB @ 1710 - 1785 MHz 25 dB @ 1850 - 1910 MHz 25 dB @ 4800 - 5000 MHz 15 dB @ 7200 - 7500 MHz	9.5 dB	2520

We design, develop, and manufacture passive RF Diplexers/Triplexer for GPS/GLNSS+BLE/WiFi + WLAN for portable applications. Small EIA 0603 or 0805 are achievable using LTCC technology integrated to receive and filter, and split 1.5, 2.45, and 5.5GHz signals for various RF chipsets who offer combined functionality. These components are also used in wideband antenna systems where diplexing/triplexing RF signals is required



Basic case size drawings for above part numbers are located on pages 39-40.

Detailed specifications and performance curves for the RF Ceramic Component line are located on our website.

BAND-PASS FILTERS: 2.45 GHZ

Part Number	Frequency (MHz)	Insertion Loss (max.)	Attenuation (min)	Return Loss (min)	Case Size (EIA)
2450BP39D100E	2400 - 2500	1.2 dB	30 @ 880 - 915 MHz 30 @ 1710 - 1785 MHz 25 @ 1850 - 1910 MHz 2 @ 2700 MHz 25 @ 4800 - 5000 MHz 15 @ 7200 - 7500 MHz	9.5 dB	2520
2450BP39F100A	2400 - 2500	2.4 dB	45 dB @ 880 - 915 MHz 48 dB @ 1710 - 1990 MHz 20 dB @ 2110 - 2170 MHz 30 dB @ 4800 - 5000 MHz 36 dB @ 7200 - 7500 MHz	9.5 dB	2520
2450BP41D100A	2400 - 2500	2.3 dB	40 dB @ 1200 - 1800 GHz 30 dB @ 2100 GHz 12 dB @ 2200 GHz 35 dB @ 4800 - 5000 GHz	9.5 dB	See Spec Sheet
2450BP41D100B	2400 - 2500	1.3 dB	30 dB @ 880 - 915 MHz 30 dB @ 1710 - 1785 MHz 20 dB @ 1850 - 1910 MHz 25 dB @ 4800 - 5000 MHz 20 dB @ 7200 - 7500 MHz	9.5 dB	See Spec Sheet
2500BP15M400	2300 - 2700	2.0 dB	15 dB @ 100 - 1800 MHz 20 dB @ 3400 - 11700 MHz	9.5 dB	2520

BAND-PASS FILTERS: 5.5 GHZ

Part Number	Frequency (MHz)	Insertion Loss (max.)	Attenuation (min)	Return Loss (min)	Case Size
5515BP15B975	4900 - 5875	1.5 dB	30 dB @ 3500 MHz	9.5 dB	0805
5515BP15C725	5150 - 5875	2.0 dB	30 dB @ 500 - 4000 MHz 20 dB @ 4600 MHz 15 dB @ 10300 - 11800 MHz	9.5 dB	0805
5515BP15C975	4900 - 5875	1.8 dB	30 dB @ 500 - 4000MHz 20 dB @ 4200MHz 15 dB @ 9800 - 11750MHz	8.5 dB	0805
5515BP15C1020	4900 - 5920	1.5 dB	30 dB @ 3500 MHz	9.5 dB	0805



Compact SMD filters developed with “easy RF” in mind provide passive >35dB attenuation levels very close to passband without compromising insertion loss. The recommended application is MoCA D-Band. This cost effective filter was designed to use a small effective footprint and easily matched to 75ohm systems. p/n 1400BP41A0550

Basic case size drawings for above part numbers are located on pages 39-40.

Detailed specifications and performance curves for the RF Ceramic Component line are located on our website.

BAND-PASS FILTERS: OTHER

Part Number	Frequency (MHz)	Insertion Loss (max)	Attenuation (min)	Return Loss (min)	Case Size (EIA)
1200BP44A575	950 - 1525	2.8 dB	25 dB @ 100 - 480 MHz 25 dB @ 1900 - 3050 MHz	7.0 dB	1812
1810BP07B200	1700 - 1900	1.8 dB	20 dB @ 855-955 (Prelim.) 10 dB @ 2565-2865 (Prelim.)	TBD	0402
1906BP18C027	1893 - 1920	3.0 dB	40 dB @ 1427 - 1454 MHz 35 dB @ 1660 - 1687 MHz 15 dB @ 2126 - 2153 MHz	9.5 dB	See Spec Sheet
1906BP39B027	1893 - 1920	2.8 dB	40 dB @ 1660 MHz 12 dB @ 2139 MHz	9.5 dB	See Spec Sheet
2593BP44B186	2500 - 2686	2.0 dB	40 dB @ 1870 - 2056 MHz	9.5 dB	1812
2598BP39A0205	2495 - 2700	3.0 dB	12 dB @ 2039 - 2244 MHz 24 dB @ 2951 - 3156 MHz 12 dB @ 4990 - 5400 MHz	9.5 dB	See Spec Sheet
2600BP14M0200	2500 - 2700	2.2 dB max @ 25°C 2.5 dB max @ -40 - 85°C	30 dB @ 806 - 915MHz 30 dB @ 1710 - 1785MHz 30 dB @ 1850 - 1910MHz 30 dB @ 1920 - 1980MHz 13 dB @ 3300 - 3900MHz 20 dB @ 4900 - 5900MHz	9.5 dB	See Spec Sheet
3600BP14M0600	3300 - 3700	1.8 dB max @ 25°C 2.0 dB max @ -40 - 85°C	30 dB @ 806 - 915MHz 30 dB @ 1710 - 1785MHz 30 dB @ 1850 - 1910MHz 30 dB @ 1920 - 1980MHz 31 dB @ 2400 - 2500MHz 18 dB @ 4900 - 5900MHz	12 dB	See Spec Sheet
3600BP15M600	3300 - 3900	1.8 dB	15 dB @ 100 - 2600 MHz 9 dB @ 4400 MHz 20 dB @ 6000 - 9900 MHz	9.5 dB	0805
3960BP39A1584	3168 - 4752	2.5 dB	30 dB @ 2400 - 2500 MHz 12 dB @ 5150 MHz 25 dB @ 5950 MHz	9.5 dB	See Spec Sheet
4000BP15U1800	3100 - 4900	2.0 dB	25 dB @ 1.75 GHz 13 dB @ 2.10 GHz	8.5 dB	0805
4560BP39A0180	4470 - 4650	2.97 dB	48.3 dB @ < 2540 MHz 19.1 dB @ 4020 MHz 19 dB @ 5150 - 5350 MHz 35.9 dB @ 5725 - 7000 MHz	17.5 dB	See Spec Sheet

Basic case size drawings for above part numbers are located on pages 39-40.

Detailed specifications and performance curves for the RF Ceramic Component line are located on our website.

HIGH-PASS FILTERS

Part Number	Frequency (MHz)	Insertion Loss (max)	Attenuation (min)	Return Loss (min)	Case Size (EIA)
1900HP41B500	1650 - 2150	2.0 dB (Prelim)	27 dB @ 950 - 1450 MHz (Prelim)	8.5 dB	1210
1900HP41C0500	1650 - 2150	2.0 dB	27 dB @ 950 - 1450 MHz	8.5 dB	1210
2450HP14A100	2400 - 2500	1.0 dB	9 dB @ 824 - 960 MHz 20 dB @ 1917 MHz	9.5 dB	1210
2450HP15A100	2400 - 2500	0.85 dB	25 dB @ 875 - 920 MHz 20 dB @ 1705 - 1790 MHz 19 dB @ 1845 - 1915 MHz	9.5 dB	See Spec Sheet
3550HP15A0500	3300 - 3800	0.6 dB max. @ 25°C 0.8 dB max. @ -40-85°C	40 dB @ 1710-1910 MHz	9.5 dB	See Spec Sheet
5200HP15A4200	3100 - 7300	2.5 dB	30 dB @ < 2540 MHz 12 dB @ 2800 MHz	9.5 dB	See Spec Sheet

EMI FILTER

Part Number	No. of Sections	Cutoff Freq (MHz)	Attenuation (min)	Case Size
0400FA15A0400	4	400	20 dB @ 800 - 1000 MHz	See Spec Sheet

JOHANSON-TEXAS INSTRUMENTS REFERENCE DESIGN - CC2530

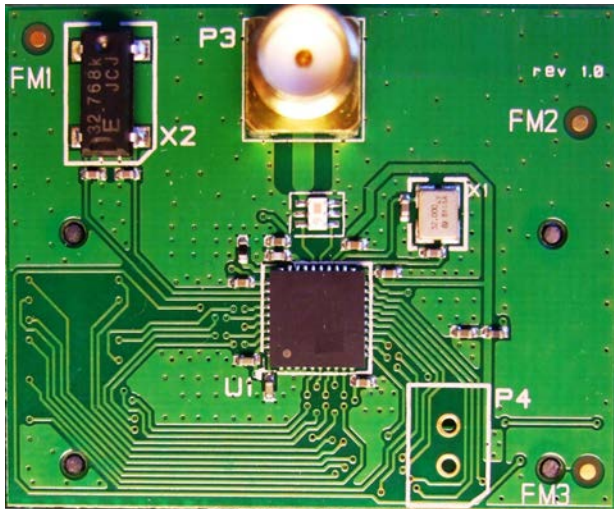

Complete passive component integration for RF Chipsets layout and design.

Johanson matched-impedance balun-filter integrated passive with TI CC2530 RF chipset.

Note: Only one component between chip and antenna SMA

Johanson p/n: 2450BM15A0002

T.I. CC2530 Reference Design using Johanson

Basic case size drawings for above part numbers are located on pages 39-40.

Detailed specifications and performance curves for the RF Ceramic Component line are located on our website.

LOW-PASS FILTERS

Part Number	Frequency (MHz)	Insertion Loss (max)	Attenuation (min)	Return Loss (min)	Case Size (EIA)
0500LP15A500	0 - 500	0.7 dB	9 dB @ 824 - 960 MHz 25 dB @ 1710 - 1990 MHz 25 dB @ 2400 - 4000 MHz	9.5 dB	See Spec Sheet
0868LP15A020	858 - 878	0.5 dB	30 dB @ 2 x Fo 40 dB @ 3 x Fo	14.0 dB	0805
0869LD14D1810	824 - 915 1710 - 1910	0.6 dB 0.6 dB	25 dB @ 1648-1830 - 25 dB @ 3420-3820 25 dB @ 2472 - 2745 - 25 dB @ 5130-5730	14 dB	0603
0869LP14A090	824 - 915	0.6 dB	20 dB @ 2x Fo 15 dB @ 3x Fo	10.9 dB	0603
0892LP07A136	824 - 960	0.7 dB	18 dB @ 1648 - 1920 MHz 25 dB @ 2472 - 2880 MHz 25 dB @ 3296 - 3840 MHz	9.5 dB	See Spec Sheet
0898LP18A035	880 - 915	0.6 dB	30 dB @ 2x Fo 18 dB @ 3x Fo	10.9 dB	1206
0915LP15A026	902 - 928	0.65 dB	25 dB @ 2x Fo 25 dB @ 3x Fo	9.5 dB	0805
0915LP15B026	902 - 928	0.5 dB	30 dB @ 2x Fo 30 dB @ 3x Fo	14.0 dB	0805
1175LP15A0550	900 - 1450	2.5 dB	25 dB @ 1650 - 2200 MHz	9.5 dB	0805
1200LP41B0500	950 - 1450	2.0 dB	24 dB @ 1650-2150 (+25°C)	8.5 dB	See Spec Sheet
1200LP41C0500	950 - 1450	2.0 dB	24 dB @ 1650-2150 (+25°C)	8.5 dB	See Spec Sheet
1748LP18A075	1710 - 1785	0.6 dB	30 dB @ 3500 MHz 20 dB @ 5240 MHz	10.9 dB	1206
1810LP07A200	1710 - 1910	0.5 dB	20 dB @ 2x Fo 20 dB @ 3x Fo	10.9 dB	0402
1810LP07B200	1710 - 1910	0.6 dB	26 dB @ 3420 - 3570 MHz 21 dB @ 3700 - 3820 MHz 21 dB @ 5130 - 5730 MHz	9.5 dB	0402
1810LP14A200	1710 - 1910	0.6 dB	30 dB @ 3420 - 3570 MHz 25 dB @ 3700 - 3820 MHz 20 dB @ 5130 - 5730 MHz	11.7 dB	0603
1880LP14A060	1850 - 1910	0.6 dB	27 dB @ 2x Fo 19 dB @ 3x Fo	11.7 dB	0603
2450LP15B050	2400 - 2500	0.5 dB	32 dB @ 2 x Fo 30 dB @ 3 x Fo 30 dB @ 4 x Fo	10.9 dB	See Spec Sheet
2400LP18A0200	2300 - 2500	0.6 dB	27 dB @ 2 x Fo 18 dB @ 3 x Fo	10.9 dB	See Spec Sheet
2450LP07A0100	2400 - 2500	0.45 dB max @ 25°C 0.55 dB max @ -40-85°C	21 dB @ 4800 - 5000 MHz 21 dB @ 7200 - 7500 MHz	11.7 dB	0402
2450LP14A100	2400 - 2500	0.5 dB	25 dB @ 2x Fo 18 dB @ 3x Fo	14.0 dB	0603

Basic case size drawings for above part numbers are located on pages 39-40.

Detailed specifications and performance curves for the RF Ceramic Component line are located on our website.

LOW-PASS FILTERS

Part Number	Frequency (MHz)	Insertion Loss (max)	Attenuation (min)	Return Loss (min)	Case Size (EIA)
2450LP14B100	2400 - 2500	0.5 dB	35 dB @ 2x F_o 25 dB @ 3x F_o	14.0 dB	0603
2450LP15A050	2400 - 2500	0.5 dB	27 dB @ 2x F_o 25 dB @ 3x F_o	10.9 dB	0805
2500LP14A0400	2300 - 2700	0.55 dB	35 dB @ 2 x F_o 25 dB @ 3 x F_o	11.7 dB	0603
2500LP14B0400	2300 - 2700	0.62 dB	27 dB @ 2 x F_o 25 dB @ 3 x F_o	14.0 dB	0603
3550LP14A300	3400 - 3700	0.65 dB	25 dB @ 3x F_o	14.0 dB	0603
5515LP15A730	5150 - 5875	0.5 dB	25 dB @ 2x F_o 18 dB @ 3x F_o	10.9 dB	0805

LOW PASS FILTER, DUAL

Part Number	Frequency (MHz)	Insertion Loss (max)	Attenuation (min)		Return Loss (min)	Case Size (EIA)
			2x F_o	3x F_o		
0869LD14C1810	824 - 915 1710 - 1910	0.6 dB 0.6 dB	25 dB 22 dB	18 dB 20 dB	9.5 dB	0603

COUPLERS, DIRECTIONAL

Part Number	Frequency (MHz)	Insertion Loss (max)	Return Loss (min)	Coupling (dB)	Isolation (min.)	Case Size (EIA)
0450CP14A0040	430 - 470	0.2 dB	20.8 dB	27.5 ± 2.0 dB	45.0 dB	0603
0869CP14A090	824 - 915	0.3 dB	15.6 dB	17 ± 1.0 dB	26.0 dB	0603
0898CP14A035	880 - 915	0.28 dB	15.6 dB	18 ± 1.0 dB	26.0 dB	0603
0898CP15A035	880 - 915	0.50 dB	14.0 dB	20 ± 1.0 dB	25.0 dB	0805
0967CP14A024	955 - 979	0.50 dB	15.6 dB	12.5 ± 1.0 dB	19.0 dB	0603
1810CP14A200	1710 - 1910	0.30 dB	15.6 dB	20 ± 1.0 dB	25.0 dB	0603
2450CP14A100	2400 - 2500	0.74 dB	TBD dB	10 ± 1.0 dB	22.0 dB	0603
2450CP14B100	2400 - 2500	0.34 dB	TBD dB	17.65 ± 1.0 dB	25.0 dB	0603

Basic case size drawings for above part numbers are located on pages 39-40.

Detailed specifications and performance curves for the RF Ceramic Component line are located on our website.

COUPLER, DIRECTIONAL – DUAL BAND

Part Number	Frequency (MHz)	Insertion Loss (max)	Return Loss (min)	Coupling (dB)	Isolation (min.)	Case Size (EIA)
0869CP14B1050	B1) 824 - 915 B2) 999 - 1102	0.4 dB 0.6 dB	15.5 dB 15.5 dB	14.2 ± 1.0 12.7 ± 1.0	23.0 dB 22.0 dB	0603

COUPLER, DIRECTIONAL - DUAL BAND, DUAL PATH

Part Number	Frequency (MHz)	Insertion Loss (max)	Return Loss (min)	Coupling (dB)	Isolation (min.)	Case Size (EIA)
0898CD15D1748	B1) 1710-1785 B2) 880-915	0.50 dB 0.35 dB	14.0 dB 14.0 dB	14.0 ± 1.5 19.2 ± 1.0	B1 In > B2 Out: 25.5 dB B1 In > B2 In: 21.0 dB B1 Out > B2 In: 22.0 dB B1 In > Term: 17.0 dB B2 In > Term: 24.0 dB	0805

COUPLER, DIRECTIONAL WITH LOW PASS FILTER

Part Number	Frequency (MHz)	Insertion Loss (max)	Return Loss (min)	Coupling (dB)	Isolation (min.)	Attenuation (min.)		Case Size (EIA)
						2 x Fo	3 x Fo	
0898CF15A035	880 - 915	0.7 dB	14 dB	20 ± 1.0	25.0 dB	22.0 dB	17.0 dB	0805
0910CF15B0100	860 - 960	1.2 dB	20 dB	10 ± 1.0	30.0 dB	27 dB @ 2 x Fo 30 dB @ 3 x Fo 30 dB @ 4 x Fo 30 dB @ 5 x Fo		See Spec Sheet
1748CF15A075	1710 - 1785	0.5 dB	14 dB	20 ± 1.0	25.0 dB	22.0 dB		0805
2450CF15A0100	2400 - 2500	0.8 dB	20 dB	15 ± 1.0	22.0 dB	20.0 dB		0805
5300CF15A0950	4900 - 5850	0.8 dB	20 dB	15 ± 1.0	22.0 dB	20.0 dB		0805

COUPLER, DIRECTIONAL 3dB HYBRID

Part Number	Frequency (MHz)	Insertion Loss (max)	Return Loss (min)	Isolation (min.)	Case Size (EIA)
0880CH15A060	850 - 910	3.3 ± 0.5 dB	14.0 dB	20.0 dB	0805
1575CH15A0030	1560 - 1590	3.3 ± 0.5 dB max.	10.0 dB		0603
1950CH15A100	1900 - 2000	3.3 ± 0.5 dB	14.0 dB	16.0 dB	0805

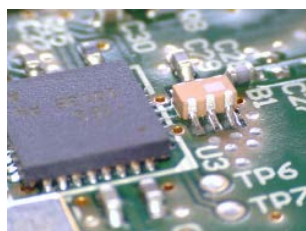

Reference design Co-development solutions with full RF Chipset impedance characterizations in all modes to design conjugate impedance balun, add a low pass, band pass or high pass filter. Integrating 25+ passives in small case size (i.e.EIA0402 -1206)

Basic case size drawings for above part numbers are located on pages 39-40.

Detailed specifications and performance curves for the RF Ceramic Component line are located on our website.

BALUNS, CERAMIC CHIP

Part Number	Frequency (MHz)	Impedance Unbal./Bal.	Insertion Loss (max)	Return Loss (min)	Phase Difference	Amplitude Difference (max)	Case Size (EIA)
0430BL15A0100	400 - 460	50/100	1.0 dB	9.5 dB	180°±10°	2.0 dB	0805
0465BL15B100	460 - 470	50/100	1.0 dB	9.5 dB	180°±10°	1.5 dB	0805
0896BL14B050	851 - 941	50/50	1.5 dB	9.5 dB	180°±10°	0.7 dB	0603
0866BL15C200	800 - 900	50/200	1.2 dB	9.5 dB	180°±10°	1.0 dB	0805
0900BL15C050	800 - 1000	50/50	1.2 dB	9.5 dB	180°±10°	2.0 dB	0805
0900BL18B100	800 - 1000	50/100	1.0 dB	9.5 dB	180°±10°	2.0 dB	1206
0900BL18B200	800 - 1000	50/200	1.0 dB	9.5 dB	180°±10°	2.0 dB	1206
0900BL15A100	900 - 1000	50/100	1.2 dB	9.5 dB	180°±10°	2.0 dB	0805
0917BL18B100	889 - 945	50/100	1.0 dB	9.5 dB	180°±10°	2.0 dB	1206
1450BL15A200	1400 - 1500	50/200	1.0 dB	9.5 dB	180°±10°	2.0 dB	0805
1600BL15B050	1500 - 1700	50/50	1.0 dB	9.5 dB	180°±10°	2.0 dB	0805
1600BL15B100	1500 - 1700	50/100	1.0 dB	9.5 dB	180°±10°	2.0 dB	0805
1800BL18B200	1700 - 1900	50/200	0.8 dB	9.5 dB	180°±10°	2.0 dB	1206
1850BL15B050	1700 - 2000	50/50	1.0 dB	9.5 dB	180°±10°	2.0 dB	0805
1850BL15B100	1700 - 2000	50/100	1.0 dB	9.5 dB	180°±10°	2.0 dB	0805
1850BL15B200	1700 - 2000	50/200	1.0 dB	9.5 dB	180°±10°	2.0 dB	0805
2100BL18B200	2000 - 2200	50/200	0.8 dB	9.5 dB	180°±10°	2.0 dB	1206
2100BL15A100	2100 - 2200	50/100	1.0 dB	9.5 dB	180°±10°	2.0 dB	0805
2450BL07A0100	2400 - 2500	50/100	1.3 dB	9.5 dB	180°±10°	2.0 dB	See Spec Sheet
2450BL14B050	2400 - 2500	50/50	1.5 dB	9.5 dB	180°±10°	2.0 dB	0603
2450BL14B100	2400 - 2500	50/100	1.3 dB	9.5 dB	180°±10°	2.0 dB	0603
2450BL14C050	2400 - 2500	50/50	1.2 dB	9.5 dB	180°±10°	2.0 dB	0603
2450BL14C100	2400 - 2500	50/100	1.2 dB	9.5 dB	180°±10°	1.5 dB	0603
2450BL14B200	2400 - 2500	50/200	1.2 dB	9.5 dB	180°±10°	2.0 dB	0603
2450BL14C200	2400 - 2500	50/200	1.3 dB	9.5 dB	180°±10°	2.0 dB	0603
2450BL15B050	2400 - 2500	50/50	1.0 dB	9.5 dB	180°±10°	2.0 dB	0805
2450BL15B100	2400 - 2500	50/100	1.0 dB	9.5 dB	180°±10°	2.0 dB	0805
2450BL15B150	2400 - 2500	50/150	1.0 dB	9.5 dB	180°±10°	2.0 dB	0805
2450BL15B200	2400 - 2500	50/200	1.0 dB	9.5 dB	180°±10°	2.0 dB	0805
2450BL15K050	2400 - 2500	50/50	1.2 dB	9.5 dB	180°±10°	2.0 dB	0805
2450BL15K100	2400 - 2500	50/100	1.0 dB	9.5 dB	180°±10°	2.0 dB	0805
2500BL14M050	2300 - 2700	50/50	1.2 dB	9.5 dB	180°±15°	1.5 dB	0603
2500BL14M100	2300 - 2700	50/100	1.2 dB	9.5 dB	180°±15°	1.5 dB	0603

Basic case size drawings for above part numbers are located on pages 39-40.

Detailed specifications and performance curves for the RF Ceramic Component line are located on our website.

BALUNS, CERAMIC CHIP

Part Number	Frequency (MHz)	Impedance Unbal./Bal.	Insertion Loss (max)	Return Loss (min)	Phase Difference	Amplitude Difference (max)	Case Size (EIA)
3600BL14M100	3300 - 3900	50/100	1.2 dB	9.5 dB	180°±15°	1.5 dB	0603
3700BL15B050	3400 - 4000	50/50	1.2 dB	9.5 dB	180°±25°	2.0 dB	0805
3700BL15B100	3400 - 4000	50/100	1.0 dB	9.5 dB	180°±20°	1.0 dB	0805
3700BL15B200	3400 - 4000	50/200	1.2 dB	9.5 dB	180°±20°	1.0 dB	0805
4000BL14U100	3100 - 4800	50/100	1.2 dB	9.5 dB	180°±20°	1.5 dB	0603
5425BL07A0200	4900 - 5950	50/200	1.2 dB	9.5 dB	180°±15°	2.0 dB	0402
5250BL15B100	5150 - 5350	50/100	1.2 dB	9.5 dB	180°±10°	2.0 dB	0805
5400BL14B100	4900 - 5875	50/100	1.0 dB	9.5 dB	180°±10°	1.5 dB	0603
5400BL15B050	4900 - 5900	50/50	1.0 dB	9.5 dB	180°±10°	2.0 dB	0805
5400BL15B100	4900 - 5900	50/100	1.0 dB	9.5 dB	180°±10°	2.0 dB	0805
5400BL15B200	4900 - 5875	50/200	1.0 dB	9.5 dB	180°±10°	2.0 dB	0805
5400BL15K050	4900 - 5875	50/50	1.2 dB	8.5 dB	180°±10°	2.0 dB	0805
5500BL15U0100	3000 - 8000	50/100	1.8 dB	9.5 dB	180°±20°	2.0 dB	0805
5400BL14B100	5150 - 5875	50/100	1.0 dB	11.7 dB	180°±10°	2.0 dB	0805
5800BL15B100	5725 - 5875	50/100	1.0 dB	9.5 dB	180°±8°	0.75 dB	0805

BALUNS, CERAMIC CHIP - DUAL BAND

Part Number	Frequency (MHz)	Impedance Unbal./Bal.	Insertion Loss (max)	Return Loss (min)	Phase Difference	Case Size (EIA)
0918BD41B050	B1: 900 - 940 B2: 1850 - 1920	50/50 50/50	1.2 dB 1.7 dB	8.5 dB 8.5 dB	180°±10° 180°±10°	1210

SPECIFIC RF CHIPSET IMPEDEANCE-MATCHED BALUN/FILTERS INTEGRATED PASSIVES; REFERENCE DESIGNS

Part Number	Frequency (MHz)	Unbalanced Impedance	Differential Balanced Imp.	Insertion Loss (max)	Return Loss (min)	Phase Difference
0896BM15A0001	863 - 928	50	Conj match to T.I. CC11XX and CC430	1.5 dB	9.5 dB	180°±10°
0896FB15A0100	863 - 928	50	Conj match to AT86RF212	1.5 dB	9.5 dB	180°±10°
0953BM15A0001	950 - 956	50	Conj. match to T.I. CC11XX	2.1 dB	9.5 dB	180°±10°
2450BM15B0009	2400 - 2500	50	Conj match to ZIC2410	1.5 dB	9.5 dB	180°±10°
2450FB15K0002	2400 - 2500	50	Conj match to CSR BC03, BC04(16-j40)	3 dB	9.54 dB	180°±10°
2450FB15K0005	2400 - 2500	50	Conj match to BC series of CSR	3.5 dB	9.5 dB	180°±10°
2450FB15K0008	2400 - 2500	50	Conj match to BC series of CSR	3.5 dB	9.5 dB	180°±10°

Basic case size drawings for above part numbers are located on pages 39-40.

Detailed specifications and performance curves for the RF Ceramic Component line are located on our website.

SPECIFIC RF CHIPSET IMPEDEANCE-MATCHED BALUN/FILTERS INTEGRATED PASSIVES; REFERENCE DESIGNS

Part Number	Frequency (MHz)	Unbalanced Impedance	Differential Balanced Imp.	Insertion Loss (max)	Return Loss (min)	Phase Difference
2450FB15L0001	2400 - 2500	50	Imp. match to AT86RF230/231 & ATmega128RFA1	1.5 dB	9.5 dB	180°±10°
2450FB15M0001	2400 - 2500	50	Conj match to MTK and BC05 chipsets	3.0 dB	9.5 dB	180°±15°
2450BM14A0002	2400 - 2500	50	Conj match to nRF24L01/ nRF24L01	2.0 dB	9.5 dB	160°±15°
2450BM15A0001	2400 - 2500	50	Conj match to T.I. Chipsets CC2430 and CC2480	1.0 dB	10.0 dB	180°±15°
2450BM15B0003	2400 - 2500	50	Conj match to T.I. Chipset 2500	2.2 dB	10.0 dB	180°±12°
2450BM15B0002	2400 - 2500	50	Conjugate match to TI Chipset 2520	1.5 dB	10.0 dB	180°±15°
2450BM15A0002	2400 - 2500	50	Conjugate match to T.I. CC253X and CC2540	1.5 dB	10.0 dB	180°±15°

BALUN-FILTER, CERAMIC CHIP

Part Number	Frequency (MHz)	Impedance Unbal./Bal.	Insertion Loss (max)	Return Loss (min)	Phase Difference	Case Size (EIA)
0783FB15A0100	779 - 787	50/100	1.5 dB	9.5 dB	180°±15°	0805
0896FB15A0100	868 - 915	50/100	1.5 dB	11.7 dB	180°±15°	0805
2345FB16A0100	2300 - 2390	50/100	2.8 dB	9.5 dB	180°±10°	0805
2345FB39A0050	2300 - 2390	50/50	3.2 dB	11.7 dB	180°±10°	1008
2450FB15A0100	2400 - 2500	50/100	1.5 dB	9.5 dB	180°±10	0805
2450FB15K0002	2400 - 2500	50 / 16+j40	3.0 dB	9.54 dB	180°±10°	0805
2450FB15M0001	2400 - 2500	50 / Conjugate match (20+j60) to MTK & BC05 Chipset	3.0 dB	9.5 dB	180°±15°	0805
2450FB39A0050	2400 - 2500	50/50	2.0 dB	9.5 dB	180°±10°	2025
2450FB39A0150	2400 - 2500	50/150	2.5 dB	9.5 dB	180°±10°	2025
2450FB39B100	2400 - 2500	50/100	2.0 dB	9.5 dB	180°±10°	2025
2595FB39A0050	2500 - 2690	50/50	3.2 dB	11.73 dB	180°± 10°	See Spec Sheet
2500FB16A0400	2300 - 2690	50/50+2.4nH	3.8 dB	9.5 dB	180°± 10°	See Spec Sheet
2595FB16A0100	2300 - 2690	50/100	2.5 dB	9.5 dB	180°± 10°	See Spec Sheet
3500FB16A0100	3400 - 3600	50/100	2.7 dB	9.5 dB	180°± 10°	See Spec Sheet
3500FB39A0050	3400 - 3600	50/50	2.9 dB	9.5 dB	180°± 12°	See Spec Sheet

Basic case size drawings for above part numbers are located on pages 39-40.

Detailed specifications and performance curves for the RF Ceramic Component line are located on our website.

DIPLEXERS, CERAMIC CHIP - LPF / HPF

Part Number	Frequency (MHz)	Insertion Loss (max)	Attenuation Low Band	Attenuation High Band	Return Loss (min)
0859DP18A1920	824 - 894 1850 - 1990	0.75 dB 0.55 dB	20 dB min	20 dB min	12 dB
0892DP14A1850	824 - 960 1710 - 1990	0.5 dB 0.8 dB	15 dB min	25 dB min	12 dB
0892DP15A1940	824 - 960	0.7 dB	16 min. @ 1648 - 1830 MHz 22 min. @ 2472 - 2745 MHz 15 min. @ 3300 - 3680 MHz 12 min. @ 4100 - 4600 MHz 15 min. @ 4920 - 5520 MHz 15 min. @ 5740 - 6440 MHz 15 min. @ 6560 - 7360 MHz	18 min. @ 3420 - 3820 MHz 20 min. @ 5130 - 5730 MHz 15 min. @ 6800 - 7680 MHz	15 dB
	1710 - 1990	0.8 dB	18 min. @ 3420 - 3820 MHz 20 min. @ 5130 - 5730 MHz 15 min. @ 6800 - 7680 MHz		
0892DP15D1940	824 - 960	0.7 dB	16 min. @ 1648 - 1830 MHz 22 min. @ 2472 - 2745 MHz 15 min. @ 3300 - 3680 MHz 12 min. @ 4100 - 4600 MHz 15 min. @ 4920 - 5520 MHz 15 min. @ 5740 - 6440 MHz 15 min. @ 6560 - 7360 MHz	18 min. @ 3420 - 3820 MHz 20 min. @ 5130 - 5730 MHz 15 min. @ 6800 - 7680 MHz	15 dB
	1710 - 1990	0.8 dB	18 min. @ 3420 - 3820 MHz 20 min. @ 5130 - 5730 MHz 15 min. @ 6800 - 7680 MHz		
0920DP18A1795_	880 - 960 1710 - 1880	0.75 dB 0.55 dB	20 dB min	20 dB min	12 dB
0967DP18A1795_	954 - 980 1710 - 1880	0.75 dB 0.55 dB	20 dB min.	20 dB min.	12 dB
2450DP15A5512	2400 - 2500 5150 - 5875	0.70 dB 0.90 dB	20 dB min	15 dB min	9.5 dB
2450DP15K5400	2400 - 2500 5150 - 5875	0.70 dB 0.90 dB	20 dB min	15 dB min	9.5 dB

Basic case size drawings for above part numbers are located on pages 39-40.

Detailed specifications and performance curves for the RF Ceramic Component line are located on our website.

DIPLEXERS, CERAMIC CHIP - LPF / BPF

Part Number	Frequency (MHz)	Insertion Loss (max)	Attenuation Low Band	Attenuation High Band	Return Loss (min)
0892DP15B1850	824 - 960 1710 - 1990	1.3 dB 1.35 dB	16 dB min @ 1628 - 1830 MHz 30 dB min @ 2472 - 2745 MHz 27 dB min @ 3296 - 4575 MHz	18 dB min @ 824 - 960 MHz 20 dB min @ 3420 - 3820 MHz 27 dB min @ 5130 - 5730 MHz	9.5 dB
2450DP15D5400	2400 - 2500 4900 - 5875	0.7 dB 1.4 dB	20 dB min. @ 4.8 - 6.0 GHz 20 dB min. @ 7.2 - 7.5 GHz	19 dB min @ 1.8 - 2.5 GHz 20 dB min. @ 10.3 - 10.7 GHz	9.5 dB
2450DP15E5400	2400 - 2500 4900 - 5900	0.7 dB 1.6 dB	20 dB min @ 4.8 - 6.0 GHz 17 dB min @ 1.8 - 2.5 GHz	20 dB min @ 7.2 - 7.5 GHz 20 dB typ. @ 10.3 - 10.7 GHz	9.5 dB
2450DP15F5400	2400 - 2500 4900 - 5900	0.7 dB 1.0 dB	18 dB min @ 4.8 - 6.0 GHz 19 dB min @ 1.8 - 2.5 GHz	18 dB min @ 7.2 - 7.5 GHz 25 dB typ. @ 10.3 - 10.7 GHz	9.5 dB
2450DP15G5400	2400 - 2500 4900 - 5900	0.7 dB 1.0 dB	18 dB min @ 4.8 - 6.0 GHz 19 dB min @ 1.8 - 2.5 GHz	18 dB min @ 7.2 - 7.5 GHz 25 dB typ. @ 10.3 - 10.7 GHz	9.5 dB
2450DP15H5400	2400 - 2500 4900 - 5900	0.7 dB 1.0 dB	18 dB min @ 4.8 - 6.0 GHz 19 dB min @ 1.8 - 2.5 GHz	18 dB min @ 7.2 - 7.5 GHz 25 dB typ. @ 10.3 - 10.7 GHz	9.5 dB
2450DP15J5400	2400 - 2500 4900 - 5900	0.7 dB 1.0 dB	18 dB min @ 4.8 - 6.0 GHz 19 dB min @ 1.8 - 2.5 GHz	18 dB min @ 7.2 - 7.5 GHz 25 dB typ. @ 10.3 - 10.7 GHz	9.5 dB

DIPLEXERS, CERAMIC CHIP - BPF / NF

Part Number	Frequency (MHz)	Insertion Loss	Attenuation	Case Size
0500DP44A1215	950 - 1450	3.6 max. (25°C)	30.0 min. @ 200 - 750MHz	See Spec Sheet
		3.9 max. (-40 - +85°C)	30.0 min. @ 1650 - 2150MHz	
	200 - 750	2.0 max. (25°C)	30.0 min. @ 950 - 1450MHz	
		2.3 max. (-40 - +85°C)		
	1650 - 2150	3.5 max. (25°C)		
		3.8 max. (-40 - +85°C)		

DIPLEXERS, CERAMIC CHIP - BPF / NF

Part Number	Frequency (MHz)	Insertion Loss	Attenuation Low Band	Attenuation High Band	Return Loss
1407DP15A2450	824 - 960	0.6 dB	15 min. @ 2400 - 2500 MHz	20 min. @ 824 - 1990 MHz	9.5 dB min.
	1710 - 1880	1.0 dB			9.5 dB min.
	1990	1.5 dB			-
	2400 - 2500	2.0 dB			9.5 dB min.

Basic case size drawings for above part numbers are located on pages 39-40.

Detailed specifications and performance curves for the RF Ceramic Component line are located on our website.

Case 18-4

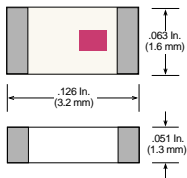

Case 42-1

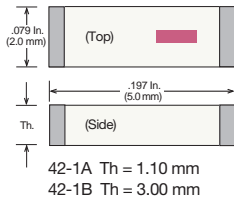

Case 42-2

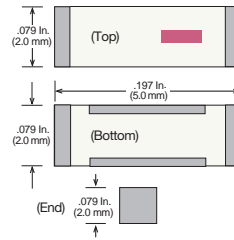

Case 43-1

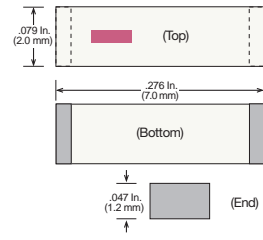

Case 43-2

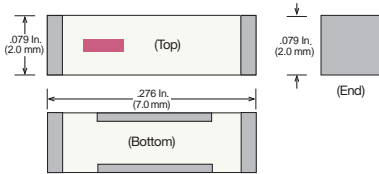

Case 43-3

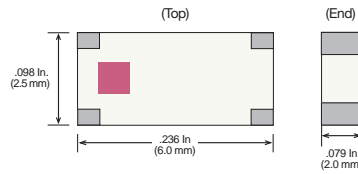

Case 44-1

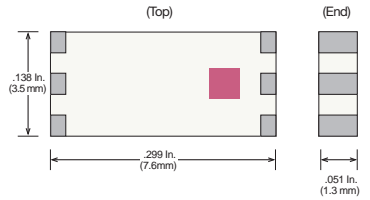

Case 44-2

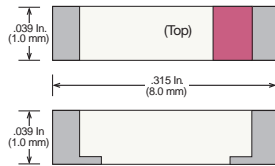

Case 45-1

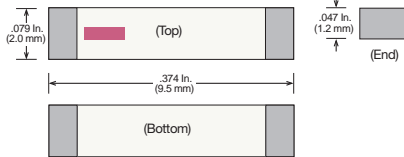

Case 46-1

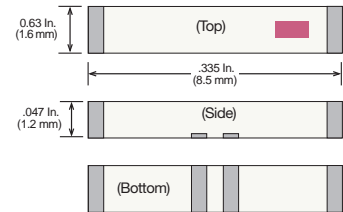

Case 47-1

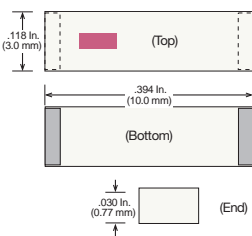

Case 50

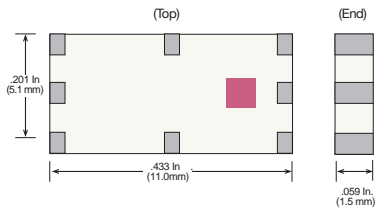

Case 51-1

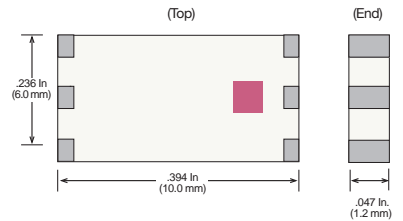

IPC EXCEPT ANTENNA

Case 07-1 (EIA 0402/ 1005)

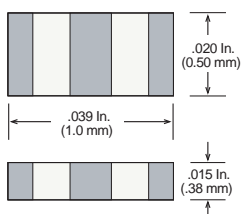

Case 07-2 (EIA 0402/ 1005)

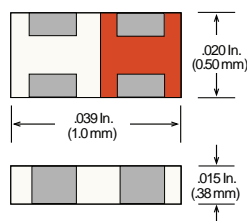

Case 14-1 (EIA 0603/ 1608)

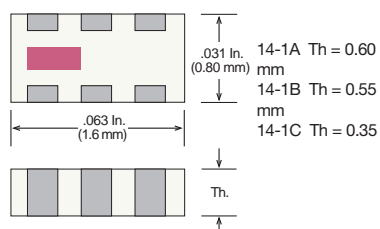

Case 14-2

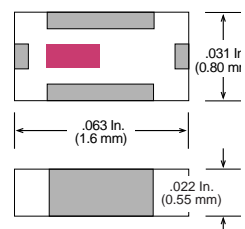

Case 15-1 (EIA 0805 / 2012)

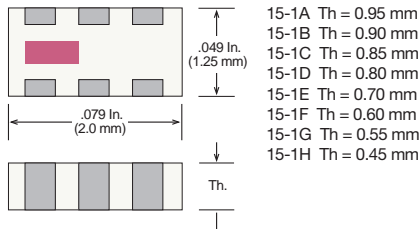

Case 15-2 (EIA 0805 / 2012)

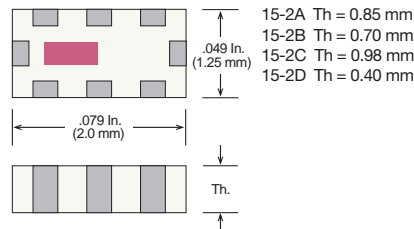

Case 15-3 (EIA 0805 / 2012)

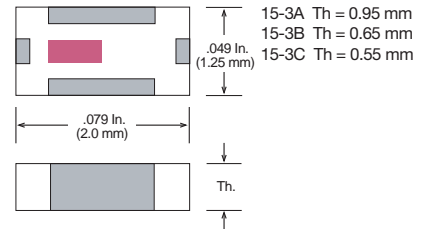

Case 15-4 (EIA 0805 / 2012)

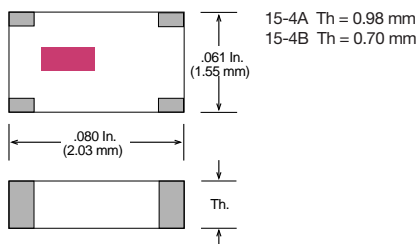

Case 18-1 (EIA 1206 / 3216)

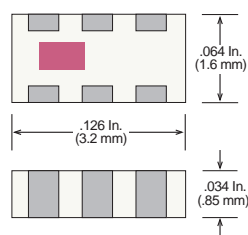

Case 18-2 (EIA 1206 / 3216)

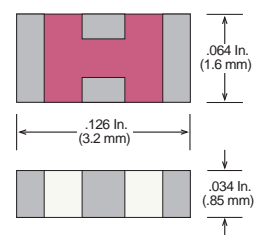

Case 18-3 (EIA 1206 / 3216)

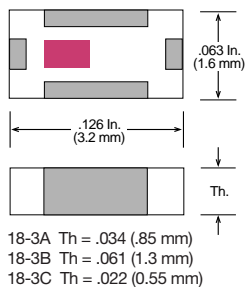

Case 18-4 (EIA 1206 / 3216)

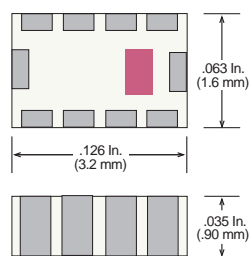

Case 39-1 (2520)

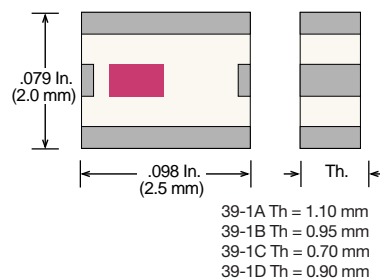

Case 39-2 (2520)

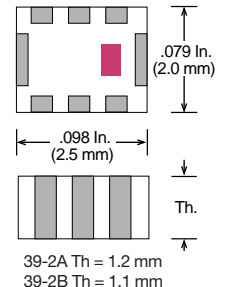

Case 39-3 (2520)

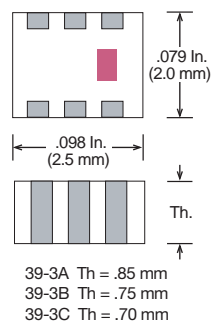

Case 39-4 (2520)

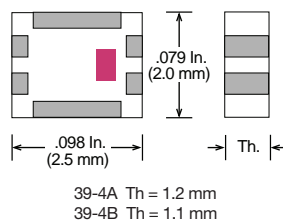

Case 41-1 (EIA 1210 / 3225)

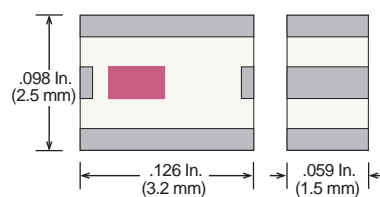

Case 41-2 (EIA 1210 / 3225)

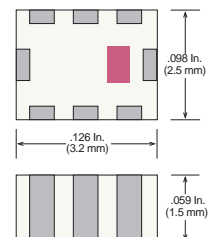

Detailed specifications and performance curves for the RF Ceramic Component line are located on our website.

CUSTOM LTCC MODULE FOUNDRY SERVICE

Johanson Technology has the capability to produce a wide range of application specific components for wireless communication such as Diplexer Switch, VCO, PA and highly integrated RF modules using LTCC (Low Temperature Co-fired Ceramic) technology. We offer extensive expertise using an internally developed LTCC tape system.

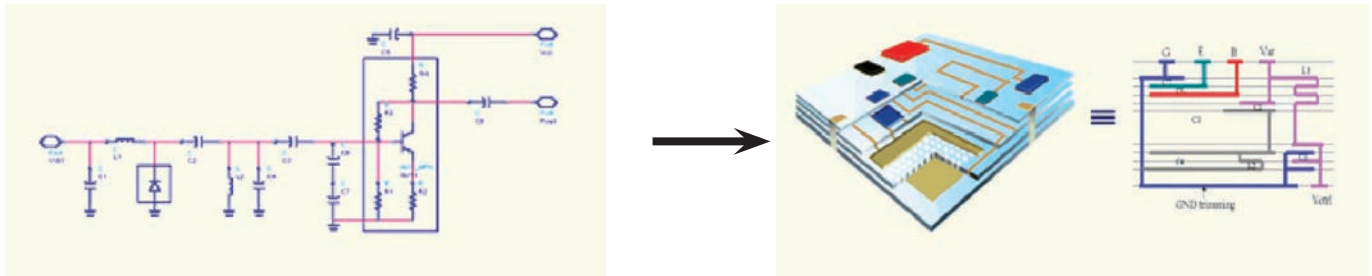

Design Rules	Standard (mm)	Advanced (mm)
(A) Via Hole Dia	0.125, 0.180	0.06 (min.)
(B) Via Cover Dot Dia	$\geq \text{Via} + 0.03$	$\geq \text{Via} + 0.02$
(C) Via Center Spacing	≥ 0.20 (for 0.07 via)	≥ 0.18 (for 0.05 via)
(D) Via Cover Dot Edge to Line Edge	> 0.10	> 0.08
(E) Line Width	≥ 0.10	≥ 0.05
(F) Line to Line Spacing	≥ 0.10	≥ 0.08
(G) Line Center Spacing	≥ 0.18	≥ 0.13
(H) Outside Edge to Via Center	≥ 0.15	≥ 0.135
(I) Line Over Outside Edge for Cutting	> 0.05	> 0.05
(J) Outside Edge to Line Clearance	> 0.10	> 0.10
(M) Buried Ground Plane Spacing	0.10	0.10
(N) Feed Thru Spacing	0.15	0.10
Substrate Thickness	0.5 to 1.6	0.3 to 2.4
Number of Layers	Up to 20	Up to 30

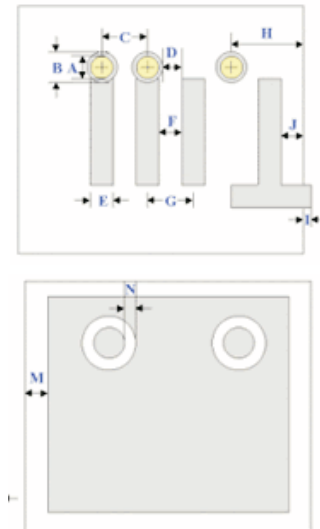

LTCC Tape Characteristics	JTI
Dielectric Constant (@ 3GHz)	7.5
Dielectric Loss (@ 3GHz)	0.33%
TCE (25-300°C) (ppm/°C)	4.7

LASERTRIM® SMT TUNER CAPACITORS

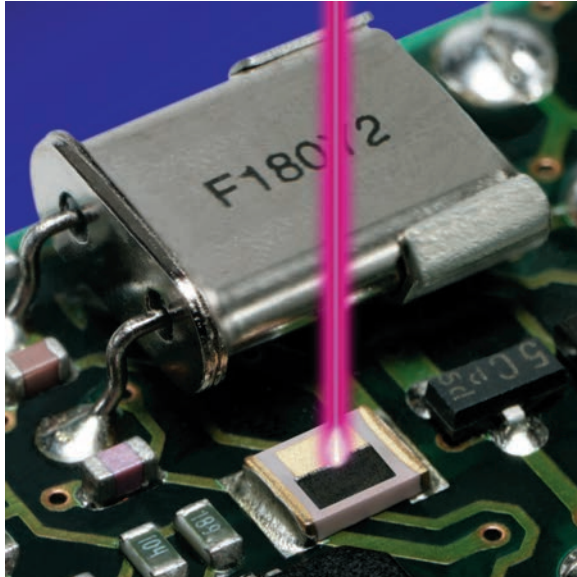

KEY FEATURES

- RoHS Compliant Parts Available
- Automates Functional Tuning
- High Resolution, High Accuracy Tuning Capability
- Highly Stable and Reliable After Adjustment
- Small, Standard SMD Chip Sizes
- Lower Placement Cost vs Mechanical

APPLICATIONS

- Portable Cellular Products
- Cable Modems
- Wireless Transceivers
- Wireless LAN
- RFID
- Custom Applications

LASERtrim® tuning capacitors are laser adjustable monolithic ceramic surface mount devices for precise functional tuning of RF circuits. LASERtrims® have the high reliability expected of conventional multi-layer chip capacitors and do not experience capacitance drift, flux entrapment and other reliability concerns associated with mechanical trimmers. Excellent post-trim Q and ESR performance are exhibited at frequencies of 100 - 2000 MHz. Offered in chip sizes 0603 to 1210 with nickel barrier terminations and tape and reel packaging, LASERtrims® are compatible with high volume SMT auto-placement and reflow techniques. These high quality, drift-free devices are ideally suited for functional tuning applications in oscillator, filter, and antenna circuits in a variety of wireless RF products.

MODEL SELECTION

RoHS P/N	EIA Case Size	CAPACITANCE		QUALITY FACTOR	
		Initial	Tuning Range	200 MHz	900 MHz
500L14N6R0XG4	0603	6.0 pF	6.0 - 1.00 pF	> 40	---
500L14N100XG4	0603	10.0 pF	10.0 - 2.00 pF	> 125	---
500L14N120XG4	0603	12.0 pF	12.0 - 2.00 pF	> 125	---
500L15M6R0XG4	0805	6.0 pF	6.0 - 1.00 pF	> 300	> 35
500L15N100XG4	0805	10.0 pF	10.0 - 1.20 pF	> 75	---
500L15N200XG4	0805	20.0 pF	20.0 - 1.50 pF	> 50	---
500L18S2R0XG4	1206	2.0 pF	2.0 - 0.50 pF	> 600	> 100
500L18M3R0XG4	1206	3.0 pF	3.0 - 1.0 pF	> 500	---
500L18M4R0XG4	1206	4.0 pF	4.0 - 1.00 pF	> 500	---
500L18M6R5XG4	1206	6.5 pF	6.5 - 1.20 pF	> 300	> 40
500L18N100XG4	1206	10.0 pF	10.0 - 2.00 pF	> 125	---
500L41S2R5XG4	1210	2.5 pF	2.5 - 0.50 pF	> 600	> 125
500L41S3R2XG4	1210	3.2 pF	3.2 - 0.50 pF	> 450	> 125
500L41M7R0XG4	1210	7.0 pF	7.0 - 1.50 pF	> 400	---
101L41M7R0XG4	1210	7.0 pF	7.0 - 1.50 pF	> 400	---
500L41M120XG4	1210	12.0 pF	12.0 - 2.00 pF	> 200	> 25
500L41N210XG4	1210	21.0 pF	21.0 - 3.00 pF	> 75	---

Initial capacitance has a tolerance of + 25% - 0%. Trim ranges are approximate and vary with laser settings and trim pattern. Custom LASERtrims® with features and performance tailored for specific applications are available.

TUNING DESCRIPTION

LASERtrim® tuning capacitors are used to provide functional RF circuitry tuning. The tuning is normally performed at a laser station integrated into the automated assembly line at a point beyond any operations that may significantly alter the circuit's RF characteristics. Tuning is performed by a computer controlled YAG laser beam which removes or "trims" the top electrode material of the LASERtrim® thereby decreasing its capacitance. Circuit parameters such as frequency or voltage are monitored during tuning and fed back to the laser controller achieving extremely precise results. Typical capacitance change in relation to the amount of electrode removal is shown in the graphs below.

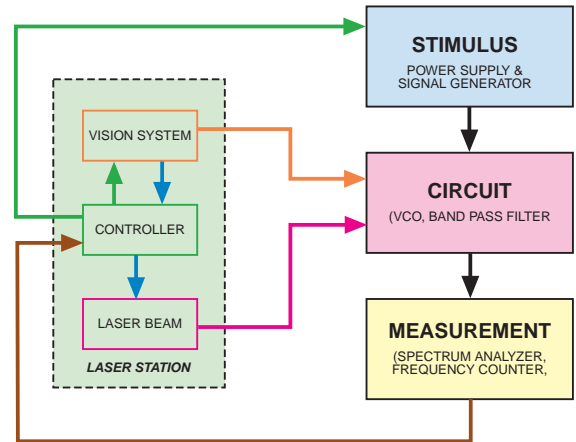

Sectional Diagram: Sizes L14 & L15

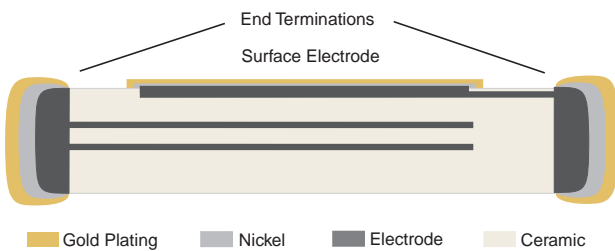

Sectional Diagram: Sizes L18 & L41

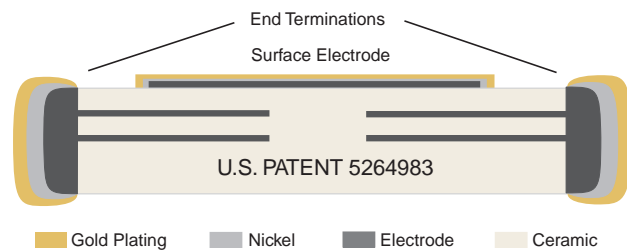

Trimming Effect on Capacitance

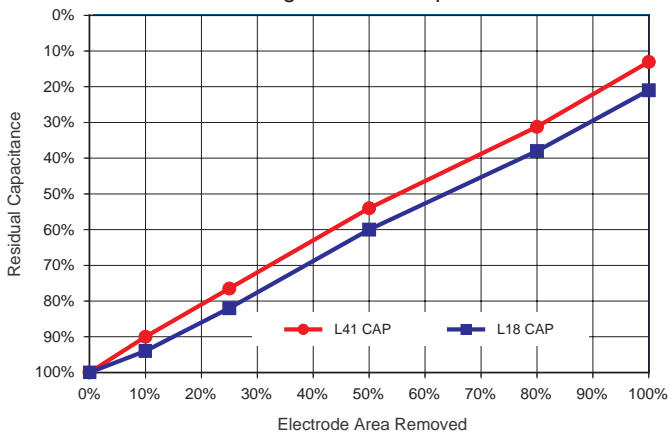

Typical Series Resonant Frequency

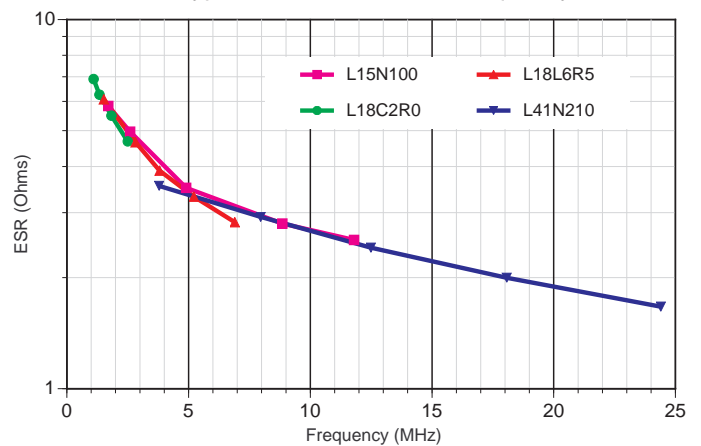

TYPICAL QUALITY FACTOR: L15N100

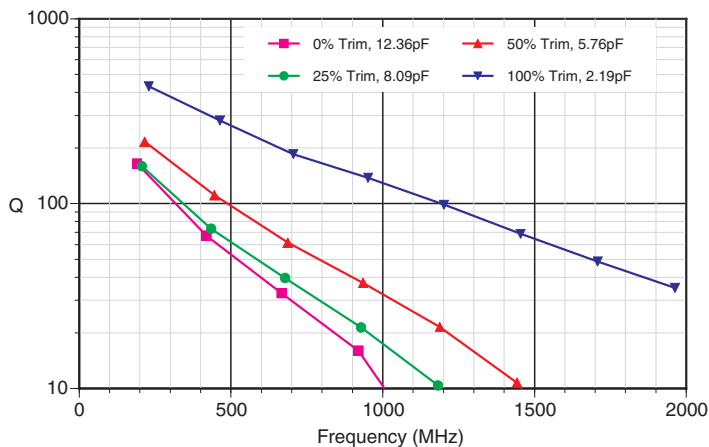

TYPICAL ESR: L15N100

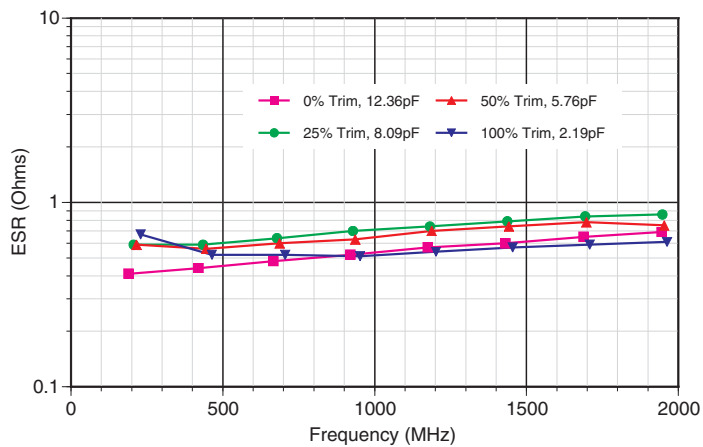

TYPICAL QUALITY FACTOR: L18C2R0

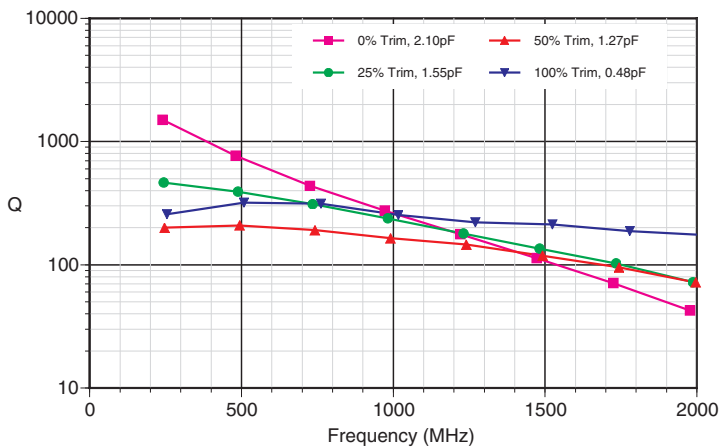

TYPICAL ESR: L18C2R0

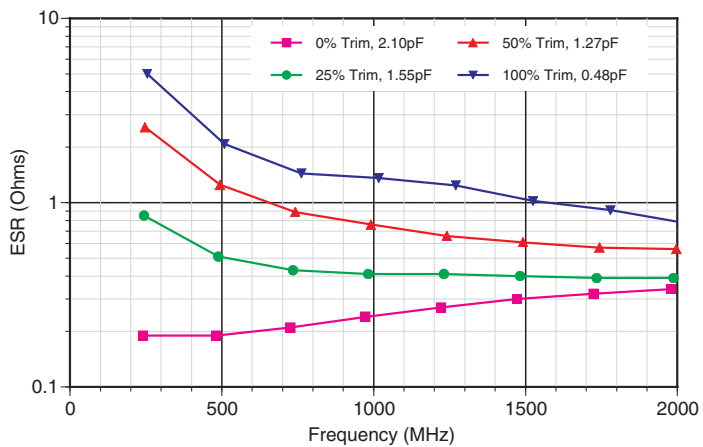

TYPICAL QUALITY FACTOR: L18L6R5

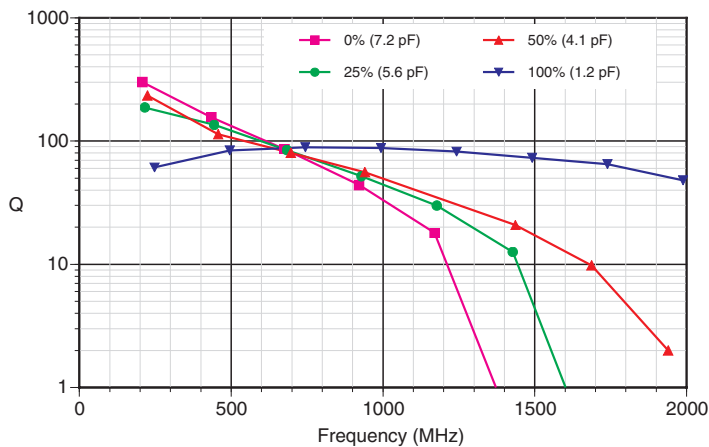

TYPICAL ESR: L18L6R5

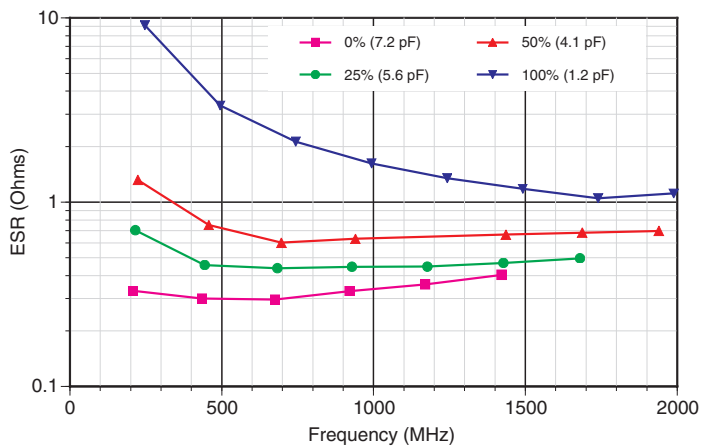

For L41 size electrical characteristics and graphs, please contact the factory.

MECHANICAL CHARACTERISTICS

SIZE	L14 (EIA 0603)		L15 (EIA 0805)		L18 (EIA 1206)		L41 (EIA 1210)	
	Inches	(mm)	Inches	(mm)	Inches	(mm)	Inches	(mm)
L	.058 ±.008	(1.47 ±.20)	.080 ±.008	(2.00 ±.20)	.122 ±.008	(3.09 ±.20)	.130 ±.008	(3.30 ±.20)
W	.032 ±.008	(0.81 ±.20)	.050 ±.008	(1.27 ±.20)	.060 ±.008	(1.52 ±.20)	.100 ±.008	(2.54 ±.20)
T	.025 MAX	(0.64 MAX)	.025 ±.005	(0.64 ±.13)	.025 ±.005	(0.64 ±.13)	.025 ±.005	(0.64 ±.13)
x & y	.004 MIN	(0.10 MIN)	.004 MIN	(0.10 MIN)	.004 MIN	(0.10 MIN)	.004 MIN	(0.10 MIN)
E/B	.005 MAX	(0.13 MAX)	.005 MIN	(0.13 MIN)	.005 MIN	(0.13 MIN)	.005 MIN	(0.13 MIN)
E/B*	.012 MAX	(0.30 MAX)	N/A (L14 Only)		N/A (L14 Only)		N/A (L14 Only)	

The diagram shows three views of the capacitor: Top View, Side View, and Bottom View. Dimensions are labeled as follows: L (length), W (width), T (thickness), x and y (lead spacing), E/B (lead width), and E/B* (lead width at the bottom view).

ELECTRICAL CHARACTERISTICS

WORKING VOLTAGE:	50 Volts DC
TEMPERATURE COEFFICIENT:	0 ± 30ppm /°C, -55 to 125°C
DISSIPATION FACTOR:	.001 (0.1%) max, 25°C
INSULATION RESISTANCE:	> 10 GΩ @ 25°C, WVDC; 125°C IR is 10% of 25°C rating.
DIELECTRIC STRENGTH:	2.5 X WVDC, 25°C, 50 mA max
TEST PARAMETERS:	1MHz ±50kHz, 1.0±0.2 VRMS, 25°C
ENVIRONMENTAL:	Meets the mechanical & environmental characteristics as given for the JTI S-Series capacitors (see second page of S-Series specification sheet), except terminal adhesion for all sizes is > 2.0 lbs.

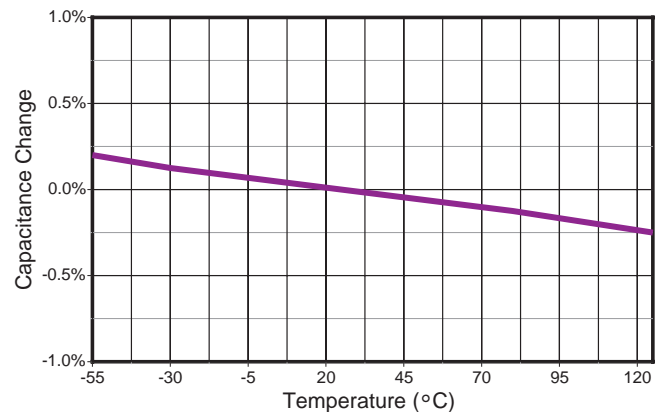

HOW TO ORDER

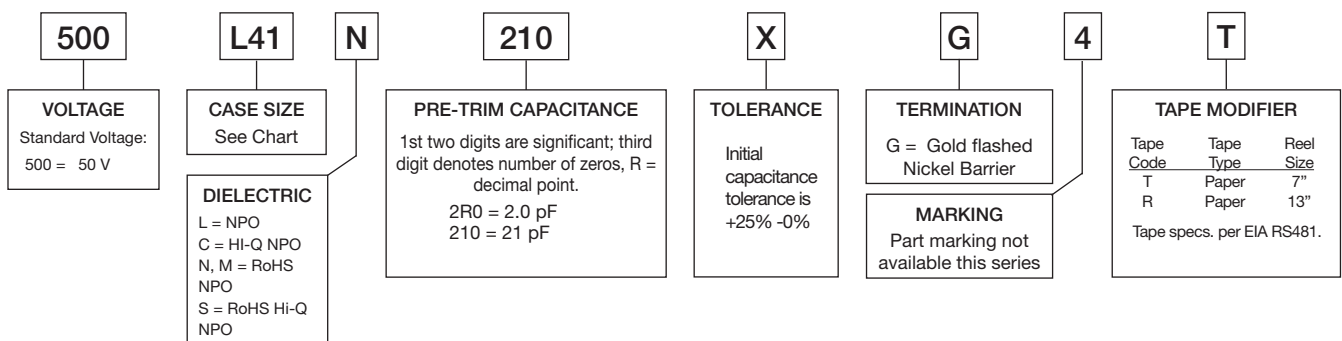

GBBL BROADBAND SINGLE LAYER CAPACITORS

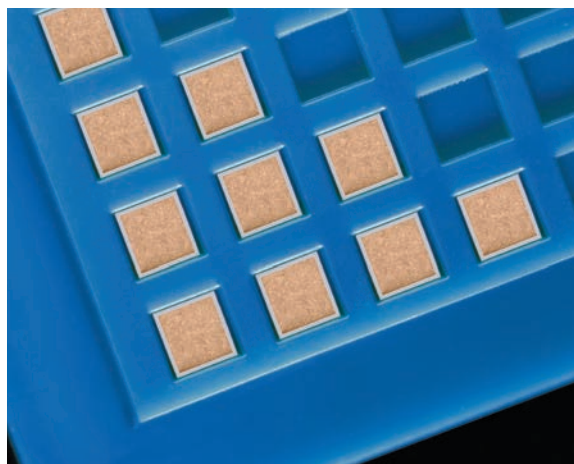

KEY FEATURES

- GBBL Dielectric Yields High Volumetric Efficiency
- Stable Temperature Coefficient: $\pm 15\%$ Max (-55°C to 125°C)
- Reduced Microphonics
- Offered With or Without Borders
- Thin Film TiW/Au or TiW/Ni/Au Electrodes
- RoHS

Custom sizes are available - Consult Factory.

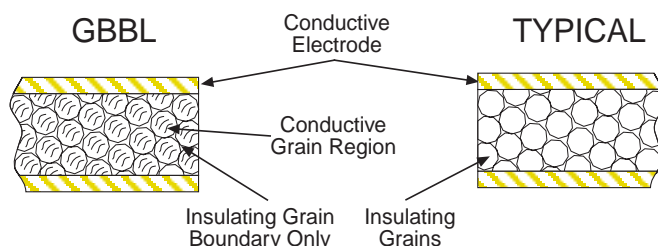

Johanson Technology's new "GBBL" microwave capacitor features high capacitance per case size without sacrificing the temperature stability associated with high dielectric constant materials. GBBL capacitors feature a proprietary X7R composition which is manufactured by a two step, atmospheric controlled sintering process. The resulting micro-structure is composed of a conducting titanate ceramic grain in contact with an insulating Grain Boundary Barrier Layer (GBBL). The insulating boundary layer acts as a very thin dielectric. The process control of the boundary thickness, in conjunction with the conductive grain size, provides the cumulative effect of a very high, yet stable, dielectric constant.

DIELECTRIC CHARACTERISTICS

TEMPERATURE COEFFICIENT: $\pm 15\%$, -55 to 125°C
 VOLTAGE RATING: 16 - 50 VDC
 DISSIPATION FACTOR: .025 (2.5%) max
 AVAILABLE CAPACITANCE: 68 pF - 0.01 μ F

DIELECTRIC STRENGTH: 2.5 X WVDC Min., 50 mA max
 TEST PARAMETERS: 1kHz ± 50 Hz, 1.0 ± 0.2 VRMS, 25°C
 INSULATION RESISTANCE: 10 G Ω Typ.

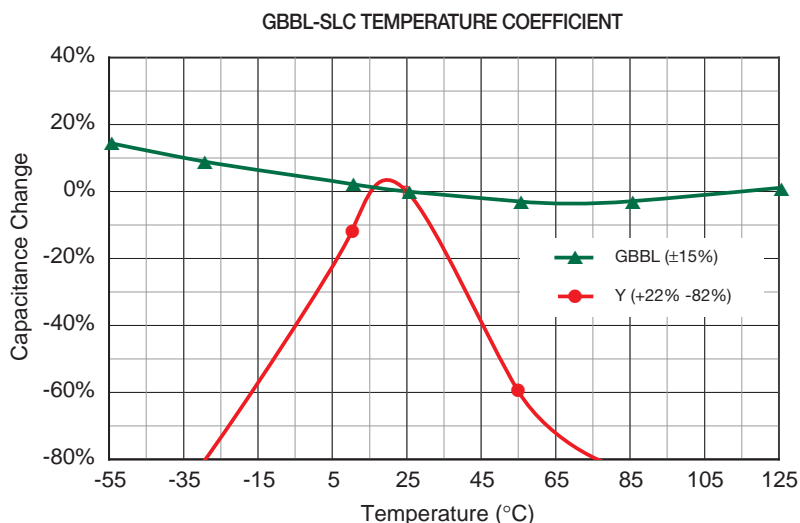

SIZE & CAPACITANCE SELECTION

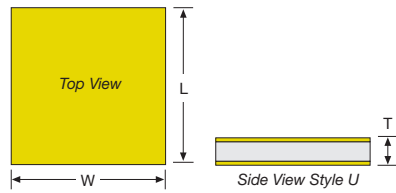

Border Style "U" Configuration

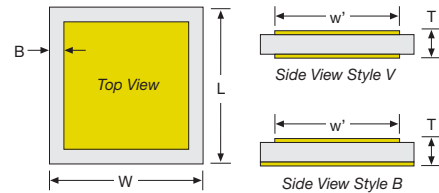

Border Style "V" & "B" Configuration

BORDER	U	V, B	U	V, B	U	V, B	U	V, B	U	V, B	U	V, B
SIZE	01		02		03		04		05		06	
W	In	.015 ±.005	.025 ±.005	.035 ±.005	.050 ±.010	.070 ±.010	.090 ±.010					
	(mm)	(0.38 ±.13)	(0.64 ±.13)	(0.89 ±.13)	(1.27 ±.25)	(1.78 ±.25)	(2.29 ±.25)					
L	In	.015 ±.005	.025 ±.005	.035 ±.005	.050 ±.010	.070 ±.010	.090 ±.010					
	(mm)	(0.38 ±.13)	(0.64 ±.13)	(0.89 ±.13)	(1.27 ±.25)	(1.78 ±.25)	(2.29 ±.25)					
T	In	.007 ± .002	.007 ± .002	.007 ± .002	.007 ± .002	.007 ± .002	.007 ± .002					
	(mm)	(0.18 ± .05)	(0.18 ± .05)	(0.18 ± .05)	(0.18 ± .05)	(0.18 ± .05)	(0.18 ± .05)					
B	In	n/a	.002±.001"	n/a	.002±.001"	n/a	.002±.001"	n/a	.002±.001"	n/a	.002±.001"	n/a
	(mm)		(0.05±.03)		(0.05±.03)		(0.05±.03)		(0.05±.03)		(0.05±.03)	
Capacitance	pF	U01	V01	U02	V02	U03	V03	U04	V04	U05	V05	U06
	Code	B01	B02	B03	B04	B05	B06					
75	750	50V	50V									
82	820	50V	50V									
100	101	50V	50V									
120	121	50V	50V									
150	151	50V	50V									
220	221	25V	25V									
270	271	25V	16V		50V							
330	331	16V	16V	50V	50V							
390	391	16V	16V	50V	50V							
470	471	16V		50V	25V							
560	561			25V	25V							
680	681			25V	16V		50V					
750	751			16V	16V	50V	50V					
820	821			16V	16V	50V	25V					
1000	102			16V	16V	25V	25V					
1200	122			16V		25V	16V		50V			
1500	152					16V	16V	50V	50V			
1800	182					16V	16V	50V	25V			
2200	222					16V		25V	25V		50V	
2700	272							25V	16V	50V	50V	
3300	332							16V	16V	50V	25V	
3900	392							16V		25V	25V	50V
4700	472									25V	16V	50V
5600	562									16V	16V	50V
6300	632									16V		25V
7500	752											16V
8200	822											16V
.01	103											16V

HOW TO ORDER GBBL-SLCs

250	V	02	A	471	K	N	4	W
VOLTAGE CODE 500 = 50 V 250 = 25 V 160 = 16 V	BORDER STYLE U = No Border V = Dual Border B = Single Border	CASE SIZE See Size Chart	DIELECTRIC A = GBBL Dielectric	CAPACITANCE 1st two digits are significant; third digit denotes number of zeros. 101 = 100 pF 471 = 470 pF 122 = 1200 pF	TOLERANCE K = ±10% M = ±20% Z = +20% -80%	TERMINATION N = TiW/Ni/Au T = TiW/Au	MARKING 4 = No mark	PACKAGING G = Gel-Pak R = 6" Ring S = Vial Pack / Bulk W = Conductive Waffle Trays

SLC MICROWAVE / MILLIMETERWAVE CAPACITORS

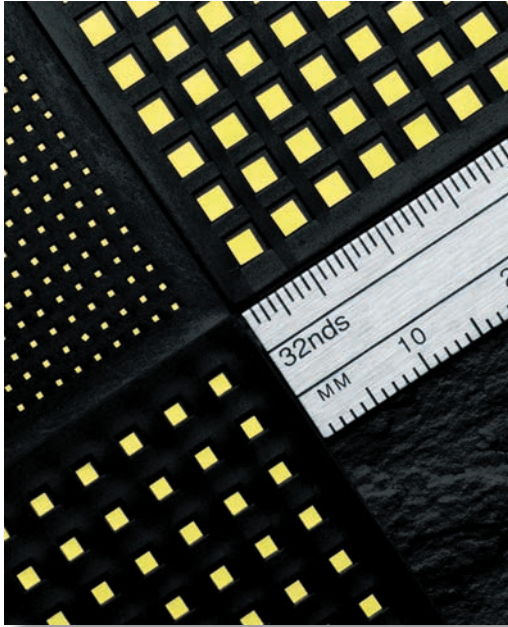

KEY FEATURES

- Ceramic SLC Low Profile Devices Exhibit Very High-Q / Low Insertion Loss, SRFs to 50 GHz
- Thin Film Gold Electrodes Provide Superior Wire Bonding & Die Attach Performance
- Four SLC Device Types to Fit Many Applications:

Standard (Die) SLCs	Border SLCs
Bar SLC Arrays	Custom SLC Products
- RoHS - Available on all dielectrics
- Custom sizes are available - please consult factory

APPLICATIONS

- Microwave Integrated Components
- GaAs Integrated Circuits
- RF/Microwave Components
- DC Block, Bypass, Tuning

DIELECTRIC CHARACTERISTICS

DIELECTRIC CODE	CONSTANT (K)	TEMPERATURE COEFFICIENT	TEMPERATURE RANGE	DISSIPATION FACTOR / FREQ.	INSULATION RESISTANCE	TEST COND.	AVAILABLE TOLERANCES
C	23	0 ± 30 ppm	-55°C to +125°C	< 0.15%/1MHz	> 1000 GΩ	1	B,C,D (A, <2pF)
K	37	0 ± 30 ppm	-55°C to +125°C	< 0.15%/1MHz	> 1000 GΩ	1	B,C,D (A, <2pF)
N	80	0 ± 30 ppm	-55°C to +125°C	< 0.15%/1MHz	> 1000 GΩ	1	B,C,D (A, <2pF) (F - K, >10 pF)
U	120	-750 ± 120 ppm	-55°C to +125°C	< 0.25%/1MHz	> 1000 GΩ	1	J,K (B-D)
V	160	-1500 ± 300 ppm	-55°C to +125°C	< 0.25%/1MHz	> 1000 GΩ	1	J,K (B-D)
R	280	-2200 ± 500 ppm	-55°C to +125°C	< 0.25%/1MHz	> 1000 GΩ	1	J,K (B-D)
L	350	-3300 ± 500 ppm	-55°C to +125°C	< 1.50%/1MHz	> 1000 GΩ	1	J,K,M (B-D)
D	600	± 10%	-55°C to +125°C	< 2.50%/1kHz	> 100 GΩ	2	K,M
B	1200	± 10%	-55°C to +125°C	< 2.50%/1kHz	> 100 GΩ	2	K,M
W	2000	± 15%	-55°C to +125°C	< 2.50%/1kHz	> 100 GΩ	2	K,M
X	2700	± 15%	-55°C to +125°C	< 2.50%/1kHz	> 100 GΩ	2	K,M
T	4000	± 15%	-55°C to +125°C	< 2.50%/1kHz	> 100 GΩ	2	K,M
Z	8000	+22% -56%	+10°C to +85°C	< 4.00%/1kHz	> 10 GΩ	2	M,Z
Y	12000	+22% -82%	-30°C to +85°C	< 4.00%/1kHz	> 10 GΩ	2	M,Z

VOLTAGE RATINGS: 50 & 100 WVDC

DIELECTRIC STRENGTH: 2.5 x WVDC min, 25°C, 50 mA max

TEST CONDITIONS: 1) All Values: 1.0±0.2 VRMS @1MHz, 25°C
2) Values ≤100pF: Cond.1; Values >100pF: 1.0±0.2 VRMS @1KHZ, 25°C



V-SERIES & B-SERIES BORDER SLC CAPACITORS

Recessed SLC electrode borders help prevent shorting from conductive epoxy squeeze-up and aid visual recognition equipment. The V-Series SLCs feature dual borders (top & bottom) while the B-Series SLCs feature a single border (top-only).

V-SERIES & B-SERIES CAPACITANCE SELECTION

CAP. CODE VALUE	V10 100V	V12 100V	V15 100V	V20 100V	V25 100V	V30 100V	V40 100V	V50 100V
0R1	0.1 pF	C	C	C				
0R2	0.2 pF	N	K	C	C			
0R3	0.3 pF	N	N	K	C	C		
0R4	0.4 pF	V	N	N	K	C		
0R5	0.5 pF	V	N	N	K	C	C	
0R6	0.6 pF	V	V	N	K	K	C	
0R7	0.7 pF	V	V	V	N	K	C	
0R8	0.8 pF	R	V	V	N	K	C	
0R9	0.9 pF	R	V	V	N	K	C	C
1R0	1.0 pF	R	V	V	N	K	K	C
1R1	1.1 pF	R	R	V	N	N	K	C
1R2	1.2 pF	L	R	V	N	N	K	C
1R3	1.3 pF	L	R	R	N	N	K	C
1R4	1.4 pF	L	R	R	N	N	K	C
1R5	1.5 pF	L	R	R	V	N	K	C
1R6	1.6 pF	D	R	R	V	N	K	K
1R7	1.7 pF	D	R	R	V	N	K	K
1R8	1.8 pF	D	L	R	V	N	K	K
1R9	1.9 pF	D	L	L	V	N	N	K
2R0	2.0 pF	D	L	L	V	N	N	K
2R1	2.1 pF	D	L	L	V	N	N	K
2R2	2.2 pF	D	L	L	V	V	N	K
2R4	2.4 pF	D	L	L	V	V	N	K
2R7	2.7 pF	D	D	L	V	V	N	K
3R0	3.0 pF	B	D	D	L	V	N	K
3R3	3.3 pF	B	D	D	L	V	N	K
3R6	3.6 pF	B	D	D	L	V	N	K
3R9	3.9 pF	B	D	D	L	V	V	N
4R3	4.3 pF	B	D	D	L	R	V	N
4R7	4.7 pF	B	B	D	L	R	V	N
5R1	5.1 pF	B	B	D	L	R	V	N
5R6	5.6 pF	B	B	B	L	R	V	N
6R2	6.2 pF	W	B	B	D	R	V	N
6R8	6.8 pF	W	B	B	D	R	V	N

CAP. CODE VALUE	V10 100V	V12 100V	V15 100V	V20 100V	V25 100V	V30 100V	V40 100V	V50 100V
6R8	6.8 pF	W	B	B	D	R	V	N
7R5	7.5 pF	W	B	B	D	L	R	V
8R2	8.2 pF	W	W	B	D	L	R	V
9R1	9.1 pF	W	W	B	D	D	R	V
100	10 pF	X	W	W	D	D	L	V
120	12 pF	X	W	W	B	D	L	R
150	15 pF	T	X	W	B	D	L	R
180	18 pF	T	X	X	B	D	D	R
200	20 pF	T	T	X	B	B	D	L
220	22 pF	Z	T	X	B	B	D	L
270	27 pF	Z	T	T	W	B	D	L
330	33 pF	Y	Z	T	W	B	B	D
390	39 pF	Y	Z	Z	X	W	B	D
470	47 pF	Y	Z	Z	X	W	B	D
500	50 pF	Y	Y	Z	X	W	B	D
510	51 pF	Y	Y	Z	T	X	B	D
560	56 pF	Y	Y	Z	T	X	B	D
680	68 pF		Y	Y	T	X	W	B
820	82 pF		Y	Y	Z	T	W	B
101	100 pF			Y	Z	T	X	W
121	120 pF				Z	T	X	W
151	150 pF				Y	Z	T	X
181	180 pF				Y	Z	T	X
201	200 pF				Y	Z	T	X
221	220 pF				Y	Y	Z	T
271	270 pF					Y	Z	T
331	330 pF					Y	Y	Z
391	390 pF						Y	Z
471	470 pF						Y	Z
561	560 pF						Y	Y
681	680 pF							Y
821	820 pF							Y
102	1000 pF							Y
122	1200 pF							Y

Color breaks used to highlight changes in dielectric material, letters indicate the specific material.

V-SERIES & B-SERIES MECHANICAL CHARACTERISTICS

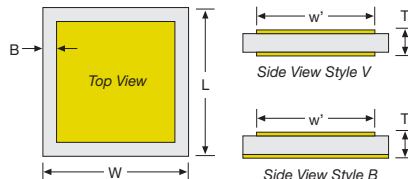

SIZE	V10	V12	V15	V20	V25	V30	V40	V50
W&L ±.001" (mm)	.010 (0.25)	.012 (0.30)	.015 (0.38)	.020 (0.51)	.025 (0.64)	.030 (0.76)	.040 (1.02)	.050 (1.27)
w' NOM. (mm)	.007 (0.17)	.008 (0.20)	.011 (0.28)	.016 (0.41)	.020 (0.51)	.026 (0.66)	.036 (0.91)	.044 (1.12)
B ±.001" (mm)	.001* (0.025)*	.001* (0.025)*	.002 (0.051)	.002 (0.051)	.002 (0.051)	.002 (0.051)	.002 (0.051)	.003 (0.076)
T ±.002" (mm)	NOM. 0.004" ~ 0.008" (NOM. 0.10 ~ 0.20)							

*Min Border 0.0005" Contact factory for other sizes, values or configurations

U-SERIES STANDARD SINGLE LAYER CAPACITORS

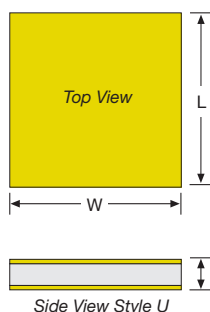

SIZE	U10	U12	U15	U20	U25	U30	U35	U50	U70	U90	
W (mm)	$+.001"$ $-.003"$.010 (0.25)	.012 (0.30)	.015 (0.38)	.020 (0.51)	.025 (0.64)	.030 (0.76)	.035 (0.89)	.050 (1.27)	.070 (1.78)	.090 (2.29)
L (mm)	MAX.	.012 (0.30)	.015 (0.38)	.020 (0.51)	.025 (0.64)	.030 (0.76)	.035 (0.89)	.040 (1.02)	.060 (1.52)	.080 (2.03)	.100 (2.54)
T (mm)	$\pm .002"$	NOM. 0.004" ~ 0.008" (NOM. 0.10 ~ 0.20)									
Contact factory for other sizes, values or configurations											

CAPACITANCE		U10	U12	U15		U20		U25		U30		U35		U50	U70	U90	CAPACITANCE	
CODE	VALUE	50V	50V	50V	100V	50V	100V	50V	100V	50V	100V	50V	100V	100V	100V	100V	CODE	VALUE
0R1	0.1 pF	C															0R1	0.1 pF
0R2	0.2 pF	K	C		C												0R2	0.2 pF
0R3	0.3 pF	N	K	C	K		C										0R3	0.3 pF
0R4	0.4 pF	N	N	K	K	C	C		C								0R4	0.4 pF
0R5	0.5 pF	U	N	K	N	C	K		C								0R5	0.5 pF
0R6	0.6 pF	V	N	K	N	C	K	C	C				C				0R6	0.6 pF
0R7	0.7 pF	V	N	N	N	K	K	C	K		C		C				0R7	0.7 pF
0R8	0.8 pF	V	U	N	N	K	N	C	K		C		C				0R8	0.8 pF
0R9	0.9 pF	R	V	N	U	K	N	C	K	C	C		C				0R9	0.9 pF
1R0	1.0 pF	R	V	N	U	K	N	K	K	C	K		C	C			1R0	1.0 pF
1R1	1.1 pF	R	V	N	V	K	N	K	K	C	K	C	C	C			1R1	1.1 pF
1R2	1.2 pF	R	V	N	V	N	N	K	N	C	K	C	C	C			1R2	1.2 pF
1R3	1.3 pF	R	V	N	V	N	N	K	N	C	K	C	C	C			1R3	1.3 pF
1R4	1.4 pF	L	V	U	V	N	N	K	N	K	K	C	K	C			1R4	1.4 pF
1R5	1.5 pF	L	V	U	V	N	N	K	N	K	K	C	K	C			1R5	1.5 pF
1R6	1.6 pF	L	R	U	V	N	U	K	N	K	N	C	K	C			1R6	1.6 pF
1R7	1.7 pF	L	R	U	V	N	U	K	N	K	N	C	K	C			1R7	1.7 pF
1R8	1.8 pF	L	R	U	R	N	U	N	N	K	N	K	K	C			1R8	1.8 pF
1R9	1.9 pF	L	R	V	R	N	U	N	N	K	N	K	K	C			1R9	1.9 pF
2R0	2.0 pF	D	R	V	R	N	U	N	N	K	N	K	K	K			2R0	2.0 pF
2R1	2.1 pF	D	L	V	R	N	V	N	N	K	N	K	K	K	C		2R1	2.1 pF
2R2	2.2 pF	D	L	V	R	U	V	N	U	K	N	K	N	K	C		2R2	2.2 pF
2R4	2.4 pF	D	L	V	R	U	V	N	U	K	N	K	N	K	C		2R4	2.4 pF
2R7	2.7 pF	D	L	R	L	U	V	N	U	N	N	K	N	K	C	C	2R7	2.7 pF
3R0	3.0 pF	D	L	R	L	U	V	N	U	N	N	K	N	K	C	C	3R0	3.0 pF
3R3	3.3 pF	D	L	R	L	V	R	N	V	N	U	K	N	K	C	C	3R3	3.3 pF
3R6	3.6 pF	D	D	R	L	V	R	U	V	N	U	K	N	K	C	C	3R6	3.6 pF
3R9	3.9 pF	B	D	R	L	V	R	U	V	N	U	N	N	N	C	C	3R9	3.9 pF
4R3	4.3 pF	B	D	R	D	V	R	U	V	N	V	N	N	N	C	C	4R3	4.3 pF
4R7	4.7 pF	B	D	L	D	R	R	U	R	N	V	N	N	N	K	C	4R7	4.7 pF
5R1	5.1 pF	B	D	L	D	R	R	V	R	U	V	N	U	N	K	C	5R1	5.1 pF
5R6	5.6 pF	B	D	L	D	R	L	V	R	U	V	N	U	N	K	K	5R6	5.6 pF
6R2	6.2 pF	B	D	D	D	R	L	V	R	U	V	N	V	N	K	K	6R2	6.2 pF
6R8	6.8 pF	B	B	D	D	R	L	R	R	V	R	N	V	N	K	K	6R8	6.8 pF
7R5	7.5 pF	W	B	D	D	R	D	R	L	V	R	U	V	N	K	K	7R5	7.5 pF
8R2	8.2 pF	W	B	D	B	L	D	R	L	V	R	U	V	N	N	K	8R2	8.2 pF
9R1	9.1 pF	W	B	D	B	L	D	R	L	V	R	U	V	N	N	N	9R1	9.1 pF
100	10 pF	X	B	D	B	L	D	R	L	R	L	V	R	V	N	N	100	10 pF

Color breaks used to highlight changes in dielectric material, letters indicate the specific material

U SERIES SLC CAPACITANCE SELECTION (CONT.)

CAPACITANCE		U10	U12	U15		U20		U25		U30		U35		U50	U70	U90	CAPACITANCE	
CODE	VALUE	50V	50V	50V	100 V	50V	100 V	50V	100 V	50V	100 V	50V	100V	100V	100V	100V	CODE	VALUE
100	10 pF	X	B	D	B	L	D	R	L	R	L	V	R	V	N	N	100	10 pF
120	12 pF	X	W	B	B	D	D	L	D	R	L	V	R	V	N	N	120	12 pF
150	15 pF	T	W	B	W	D	B	L	D	R	L	R	L	V	N	N	150	15 pF
180	18 pF	T	W	B	W	D	B	D	D	L	D	R	L	V	V	N	180	18 pF
200	20 pF	T	X	W	W	D	B	D	D	L	D	R	D	R	V	N	200	20 pF
220	22 pF	T	X	W	X	B	B	D	B	L	D	R	D	R	V	N	220	22 pF
270	27 pF	Z	T	W	X	B	W	D	B	D	D	L	D	R	V	U	270	27 pF
330	33 pF	Z	T	X	T	B	W	B	B	D	B	L	D	L	R	U	330	33 pF
390	39 pF	Z	T	X	T	W	X	B	W	D	B	D	B	L	R	V	390	39 pF
470	47 pF	Y	Z	T	T	W	X	B	W	D	B	D	B	D	R	V	470	47 pF
500	50 pF	Y	Z	T	Z	W	X	B	W	B	B	D	B	D	R	V	500	50 pF
510	51 pF	Y	Z	T	Z	W	X	B	W	B	B	D	B	D	R	V	510	51 pF
560	56 pF	Y	Z	T	Z	X	T	B	X	B	W	D	B	D	R	R	560	56 pF
680	68 pF		Z	Z	Z	X	T	W	X	B	W	B	W	D	L	R	680	68 pF
820	82 pF		Y	Z	Y	T	Z	W	T	B	X	B	X	B	D	R	820	82 pF
101	100 pF		Y	Z	Y	T	Z	X	T	W	X	B	X	B	D	L	101	100 pF
121	120 pF			Y	Y	T	Z	T	T	W	T	W	X	B	D	D	121	120 pF
151	150 pF			Y		Z	Y	T	Z	X	T	W	X	B	B	D	151	150 pF
181	180 pF			Y		Z	Y	T	Z	T	T	W	T	W	B	D	181	180 pF
201	200 pF					Z	Y	Z	Z	T	Z	X	T	W	B	B	201	200 pF
221	220 pF					Y	Y	Z	Z	T	Z	X	T	W	B	B	221	220 pF
271	270 pF					Y		Z	Y	T	Z	T	Z	X	W	B	271	270 pF
331	330 pF					Y		Y	Y	Z	Z	T	Z	X	W	W	331	330 pF
391	390 pF							Y		Z	Y	T	Z	T	X	W	391	390 pF
471	470 pF							Y		Z	Y	Z	Y	T	X	W	471	470 pF
561	560 pF							Y		Z	Y	Z	Y	T	T	X	561	560 pF
681	680 pF									Y		Z	Y	Z	T	X	681	680 pF
821	820 pF											Y		Z	T	X	821	820 pF
102	1000 pF											Y		Z	T	T	102	1000 pF
122	1200 pF													Y	Z	T	122	1200 pF
152	1500 pF													Y	Y	Z	152	1500 pF
182	1800 pF														Y	Z	182	1800 pF
202	2000 pF														Y	Z	202	2000 pF
252	2500 pF														Y	Y	252	2500 pF
402	4000 pF														Y		402	4000 pF

Color breaks used to highlight changes in dielectric material, letters indicate the specific material

HOW TO ORDER U, V, & B SERIES

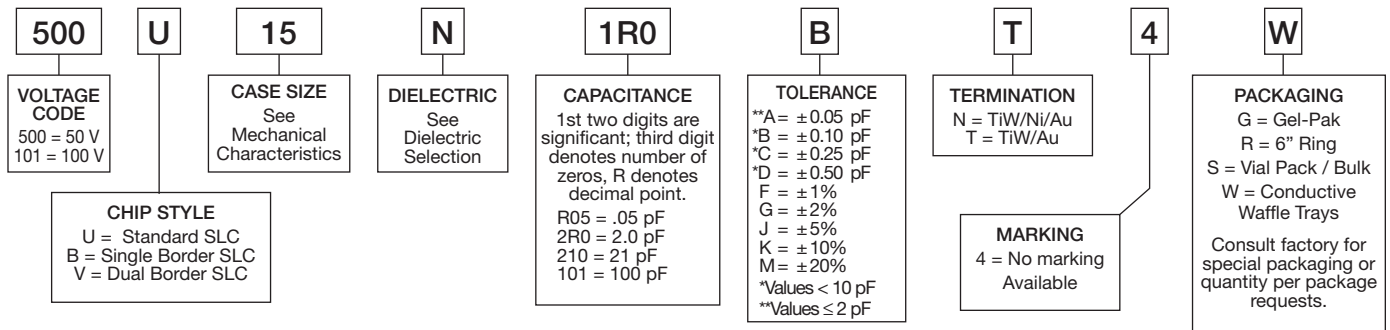

NOTE: The "U" series thick-film terminated SLC's are fully supported and orders may be placed using legacy part numbers. These parts are identified by alpha case size code and contain termination codes "G" or "9" i.e. 500UDB200JG4W.

SLC TEMPERATURE CHARACTERISTICS

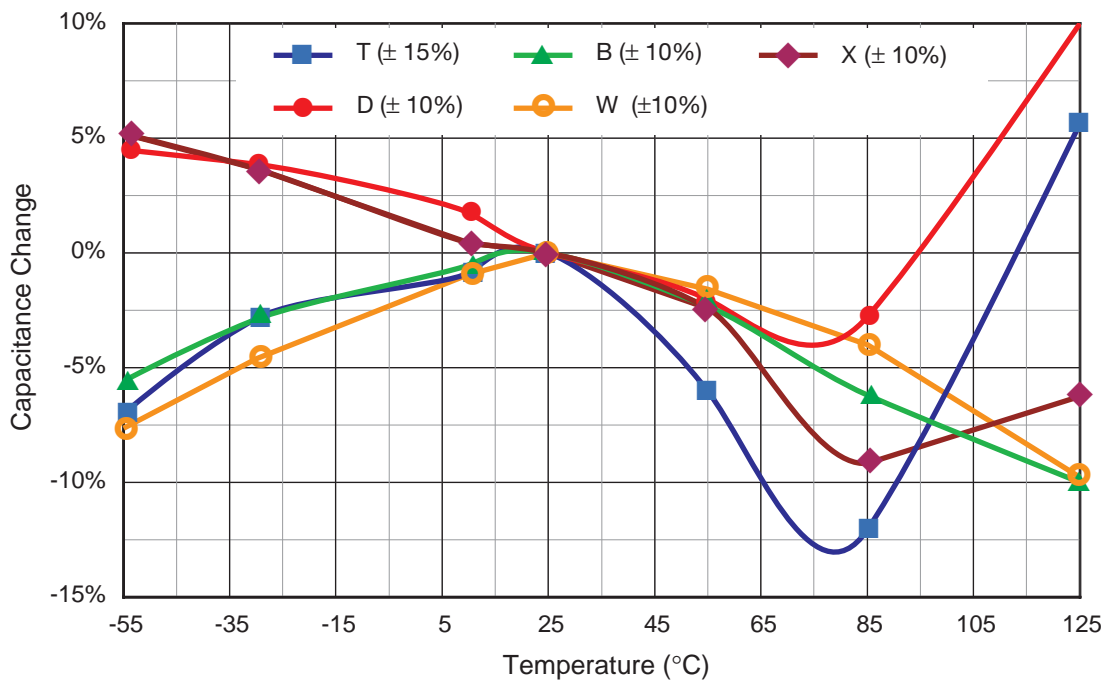
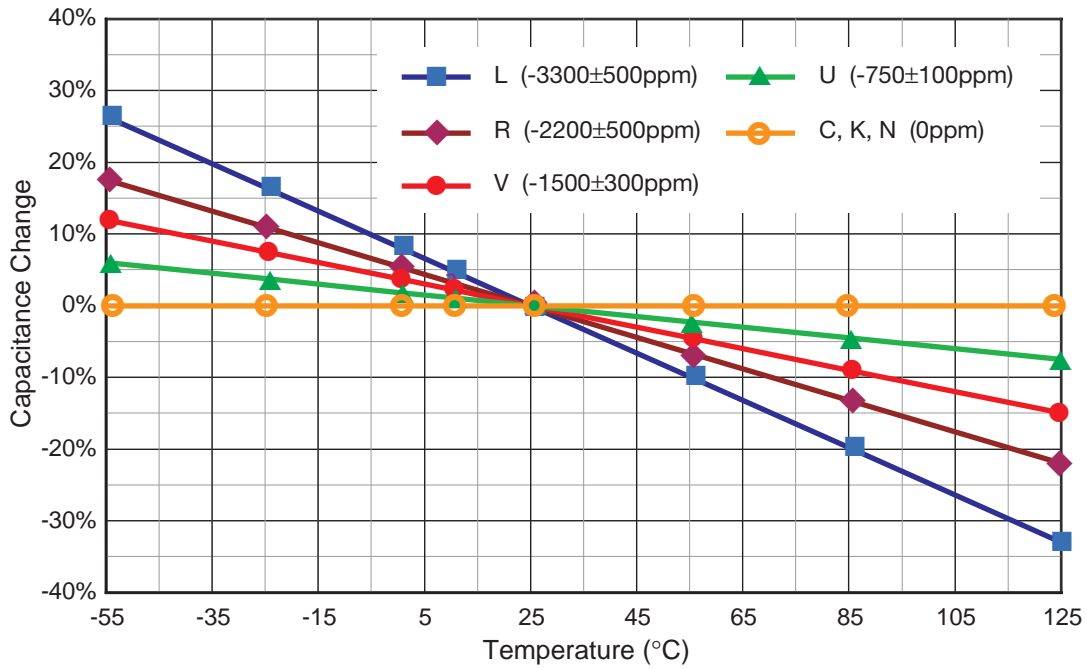

SLC TEMPERATURE CHARACTERISTICS

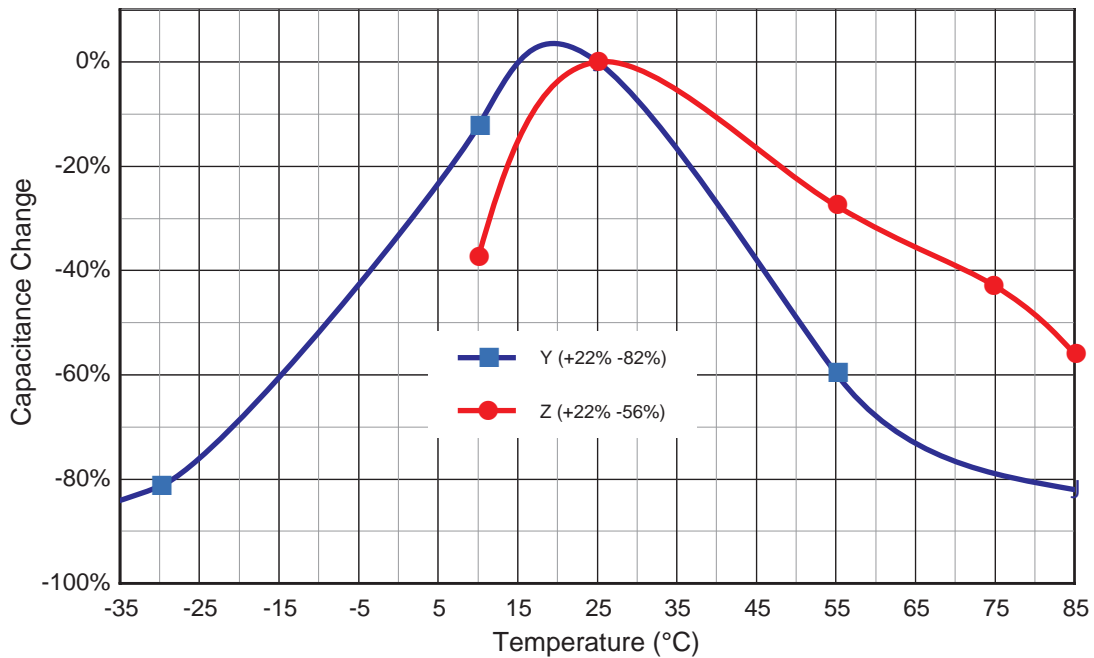

METALLIZATION CHARACTERISTICS FOR GBBL / SLC

METALLIZATION TYPE	TiW/Au (Titanium-Tungsten/Gold)	TiW/Ni/Au (Titanium-Tungsten/Nickel/Gold)
TERMINATION CODE	T	N
ATTACHMENT COMPATIBILITY	Wire / Ribbon Bonding Silver or Gold Conductive Epoxy Au/Ge or Au/Si Eutectic Preform Excellent High Temperature Resistance (400°C) Unsuitable for Pb/Sn or Au/Sn Soldering	Pb/Sn or Au/Sn Soldering Au/Sn Eutectic Preform Moderate High Temp. Resistance (325°C) Long term high temperature may cause Ni diffusion and wire bond problems on Au/Ge

SLC thick-film terminations (legacy codes "G" and "9") are still supported. Contact the factory for compatibility information.

ENVIRONMENTAL CHARACTERISTICS FOR GBBL / SLC

BOND STRENGTH:	Exceeds MIL-S-883, Meth. 2011	VIBRATION: MIL-S-202, Meth. 204-G, (30g, 10-2000 Hz)
SHEAR STRENGTH:	Exceeds MIL-S-883, Meth. 2019	BURN-IN/LIFE TEST: MIL-S-202, Meth. 108, A/F
SOLDER HEAT RESISTANCE: MIL-S-202, Meth. 210-C, (260±5°C, 5 sec.)		LOW VOLTAGE HUMIDITY: Mil-C-49464, Para. 3.17
SOLDERABILITY: MIL-S-202, Meth. 208, (245±5°C, 5 sec.)		BAROMETRIC PRESSURE: MIL-S-202, Meth. 105, B
SHOCK: MIL-S-202, Meth. 213-I, (100g, 6 msec.)		IMMERSION/SALT SPRAY: MIL-S-202, Meth. 104, B
THERMAL SHOCK: MIL-S-202, Meth. 107, A, (-55 to +125°C)		MOISTURE RESISTANCE: MIL-S-202, Meth. 106

CUSTOM SUBSTRATES & THIN FILM PRODUCTS



Metalized substrates may also be patterned to customer specifications by chemical etching, abrasive etching, or pattern plating. Please contact the factory for other types of metallization configurations other than a continuous top / bottom plating. Other termination material thicknesses are available upon request.

Johanson Technology offers a wide range of dielectrics for use in application specific environments. These materials are available both lapped and “as fired” condition as well as metalized and non-metalized substrates. Standard substrate sizes range from 0.50” x 0.50” to 1.50” x 1.50”, with larger sizes available with special order. Dielectrics are available from 0.005” to 0.050” thick.

METALLIZATION	CODE
TiW / Au	T
TiW / Ni / Au	N
TiW / Ni / Sn	V
TaN / TiW / Au	R
TiW / Ni / Cu / Ni / Au	C
80Au / 20 Sn	E
Non-Metallized	X

Note: When metallization is requested on both top and bottom sides, the metallization will wrap around the sides as a standard unless otherwise specified.

SUBSTRATE MATERIAL	MATERIAL CODE	K	TEMPERATURE COEFFICIENT	OPERATING TEMPERATURE	DISSIPATION FACTOR
ALN *	F	8.8	170 W/M deg K (Th. Cond.)	-55 to +125 deg. C	
Alumina *	G	9.9	P120 +/- 30 ppm / deg C	-55 to +125 deg. C	
Titanate Based	C	23	0 +/- 30 ppm / deg C	-55 to +125 deg. C	< 0.15% @ 1 MHz
Titanate Based	K	37	0 +/- 30 ppm / deg C	-55 to +125 deg. C	< 0.15% @ 1 MHz
Titanate Based	N	80	0 +/- 30 ppm / deg C	-55 to +125 deg. C	< 0.15% @ 1 MHz
Titanate Based	U	120	-750 +/- 120 ppm / deg C	-55 to +125 deg. C	< 0.25% @ 1 MHz
Titanate Based	V	160	-1500 +/- 300 ppm / deg C	-55 to +125 deg. C	< 0.25% @ 1 MHz
Titanate Based	R	280	-750 +/- 120 ppm / deg C	-55 to +125 deg. C	< 0.25% @ 1 MHz
Titanate Based	L	350	-750 +/- 120 ppm / deg C	-55 to +125 deg. C	< 1.50% @ 1 MHz
Titanate Based	D	600	+/- 10% (-55 to +125 C)	-55 to +125 deg. C	< 2.50% @ 1 kHz
Titanate Based	B	1200	+/- 10% (-55 to +125 C)	-55 to +125 deg. C	< 2.50% @ 1 kHz
Titanate Based	W	2000	+/- 10% (-55 to +125 C)	-55 to +125 deg. C	< 2.50% @ 1 kHz
Titanate Based	X	2700	+/- 15% (-55 to +125 C)	-55 to +125 deg. C	< 2.50% @ 1 kHz
Titanate Based	T	4000	+/- 15% (-55 to +125 C)	-55 to +125 deg. C	< 2.50% @ 1 kHz
Titanate Based	Z	8000	+22/-56% (+10 to +85 C)	-55 to +125 deg. C	< 4.00% @ 1 kHz
Titanate Based	Y	12000	+22/-82% (-30 to +85 C)	-55 to +125 deg. C	< 4.00% @ 1 kHz

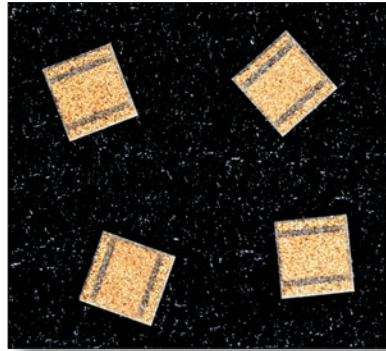
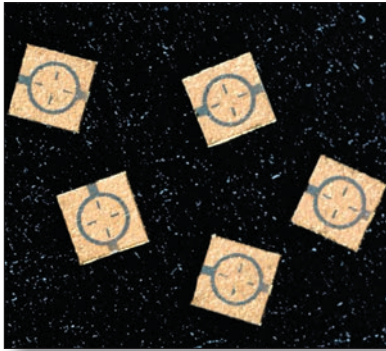

FLATNESS (Standard): 1 mil per 100 mils. Please contact the factory for other flatness options.

NOTE: The thickness specified in the JTI part number is the thickness of the dielectric material not including the termination materials.

NOTE: The standard thickness of the Nickel barrier (if used) is 10 - 20 microinches (for non-bordered parts) and is 20 - 50 microinches (for bordered parts), and the thickness of the Gold is 100 microinches minimum. Other termination material thicknesses are available upon request.

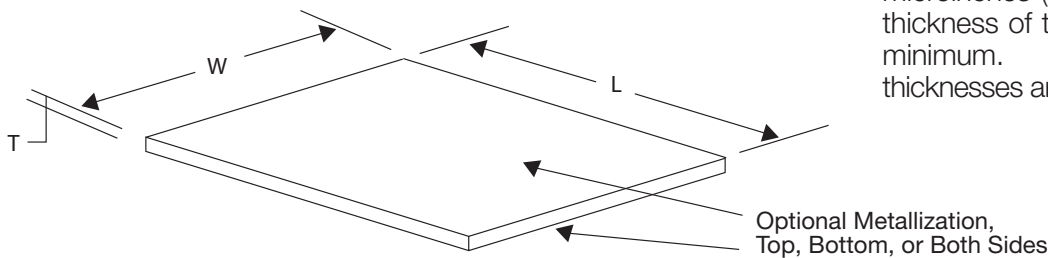

HOW TO ORDER

500	M	12	T	045	K	G	S	R	-	T	***	-	AA
<p>VOLTAGE CODE 1st two digits are significant; third digit denotes number of zeros, R denotes decimal point.</p> <p>6R0 = 6VDCW 250 = 25 VDCW 101 = 100 VDCW 501 = 500 VDCW 102 = 1000 VDCW 502 = 5000 VDCW</p>	<p>PART TYPE M = Substrate</p>	<p>DIELECTRIC CODE A = NPO/COG B = BX/X7R C = NPO D = BX F = ALUMINUM NITRIDE G = ALUMINA K = NPO L = NEG TC N = NPO Q = P90/Hi Q R = NEG TC T = X7R U = NEG TC V = NEG TC W = X7R X = X7R Y = Y5V Z = Z5U</p>	<p>THICKNESS CODE Thickness in mils 3rd digit is the decimal point</p> <p>eg: 050 = 5.0 mils eg: 065 = 6.5 mils eg: 128 = 12.8 mils</p>	<p>GS = Back side metalization code X = Underminated 9 = Thick film G = Thick film + Au H = Thick film + Ni-Au T = Thin Film TiW-AU N = Thin Film TiW-NI-AU R = TaN-TiW-Au V = TiW-Ni-Sn E = 80Au/20Sn C = TiW-Ni-Cu-Ni-Au S = Special</p>	<p>METALIZATION A or Blank = Not applicable S = Seed layer gold only P = 100 micro" min. std X = Special</p> <p>Use blank in the S column instead of "A" only if it the last character in the part#</p>	<p>THICKNESS TOLERANCE CODE A = ± 0.5 mil B = ± 1.0 mil C = ± 2.0 mil</p> <p>J = ± 5.0 % K = ± 10.0 % L = ± 15.0 % M = ± 20.0 % X = Special</p>	<p>RT = Top side metalization code X = Underminated 9 = Thick film G = Thick film + Au H = Thick film + Ni-Au T = Thin Film TiW-AU N = Thin Film TiW-NI-AU R = TaN-TiW-Au V = TiW-Ni-Sn E = 80Au/20Sn C = TiW-Ni-Cu-Ni-Au S = Special Blank = Both Sides are the Same</p>	<p>METALIZATION A or Blank = Not applicable S = Seed layer gold only P = 100 micro" min. std X = Special</p> <p>Leave R and T blank if both sides have the same type metalization.</p> <p>If metalization types are different, then back side is scribed with an X.</p>	<p>NON-STANDARD CODE Defines non-standard product marking, leading, testing, dielectric, cust. code, non-std. thk., L, W, endband & size codes, etc...</p>	<p>*** - ASTERISK Required (place holders)</p>	<p>AA</p>		



CHIP CAPACITOR PACKAGING INFORMATION

Johanson capacitors are available taped per EIA standard 481. Tape options include 5", 7" and 13" diameter reels. Johanson uses high quality, dust free, punched 8mm paper tape and plastic embossed 8mm tape for thicker MLCs. Quantity per reel ranges are listed in the tables below and are dependent on chip thickness.

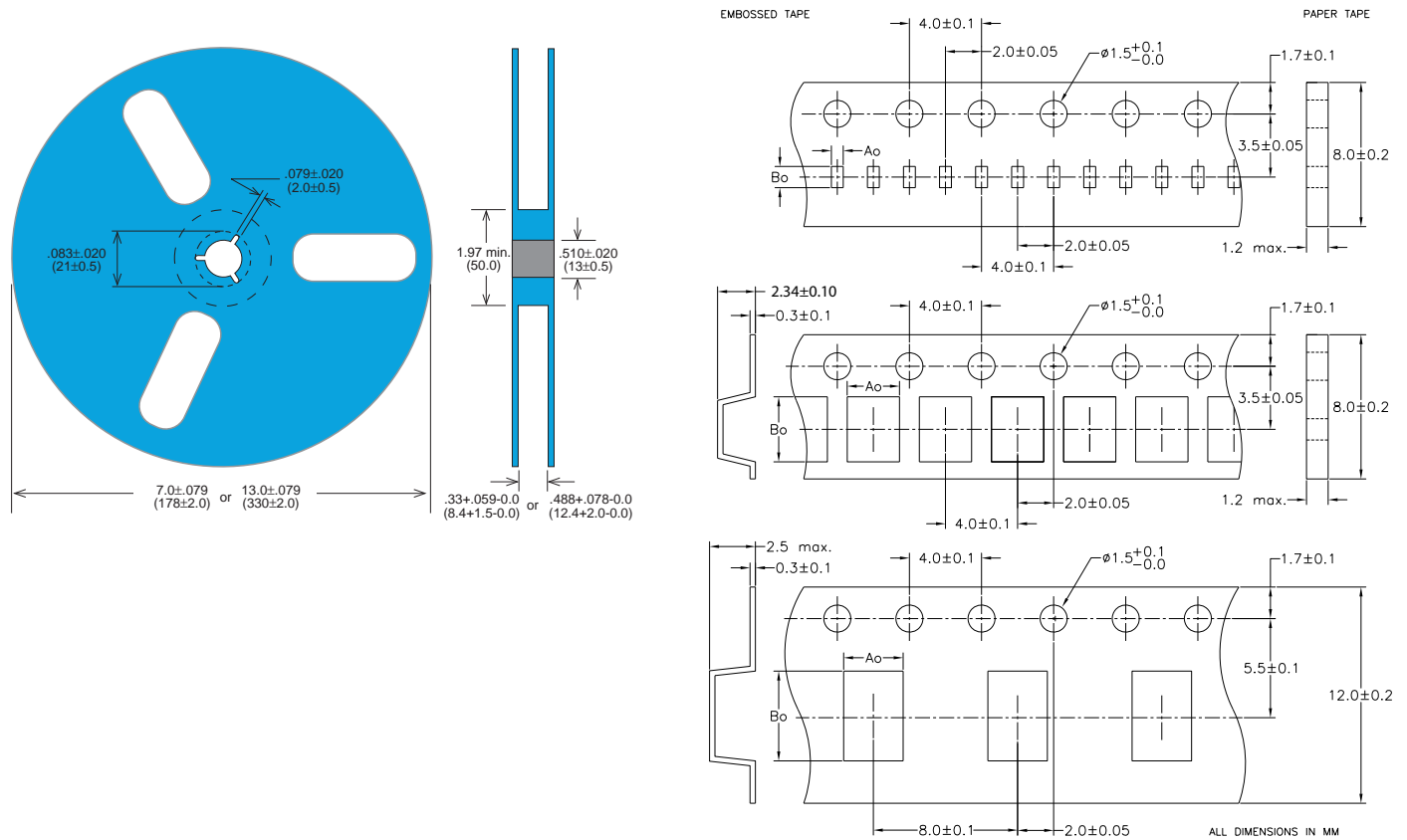

TYPE / SIZE	5" DIA. REEL SIZE			7" DIA. REEL SIZE			13" DIA. REEL SIZE		
	REEL QUANTITY	TAPE TYPE	TAPE CODE	REEL QUANTITY	TAPE TYPE	TAPE CODE	REEL QUANTITY	TAPE TYPE	TAPE CODE
R05 / 0201	500	Paper	Y	15,000	Paper	T	50,000	Paper	R
R07 / 0402	500	Paper	Y	10,000	Paper	T	N/A	N/A	N/A
R14 / 0603	500	Paper	Y	4,000	Paper	T	10,000	Paper	R
R15 / 0805	500	Embossed	Z	4,000	Embossed	E	10,000	Embossed	U
S42 / 1111	500	Embossed	Z	2,000	Embossed	E	10,000	Embossed	U
S48 / 2525	N/A			250	Embossed	E	1,000	Embossed	U
S58 / 3838	N/A			250	Embossed	E	1,000	Embossed	U
LASERtrim® (All)	500	Paper	Y	4.5-5.0K	Paper	T	15,000	Paper	R

SUBSTRATES – DEPENDS ON SIZE, TYPICAL IS 10/BOX; CAP ARRAYS - 100/TRAY
 SINGLE LAYER CAPACITORS - UP TO 50 MIL, 400/WAFFLE PACK; > 50 MIL, 100/WAFFLE PACK
 SLC'S CAN ALSO BE MOUNTED ON GRIP RINGS AND GELPAKS® AND SHIPPED IN BULK
 CUSTOM PACKAGING AND QUANTITIES ARE AVAILABLE, CONTACT THE FACTORY FOR OPTIONS
 PLEASE VISIT OUR WEB SITE FOR RF CERAMIC COMPONENT PACKAGING INFORMATION.

CHIP INDUCTOR PACKAGING INFORMATION

7" DIA. REEL SIZE			
TYPE / SIZE	REEL QUANTITY	TAPE TYPE	TAPE CODE
L-05 / 0201	15,000	Paper	T
L-07 / 0402	10,000	Paper	T
L-14 / 0603	4,000	Paper	T
L-15 / 0805	4,000	Embossed	E

Reel Dimensions (Unit: mm)

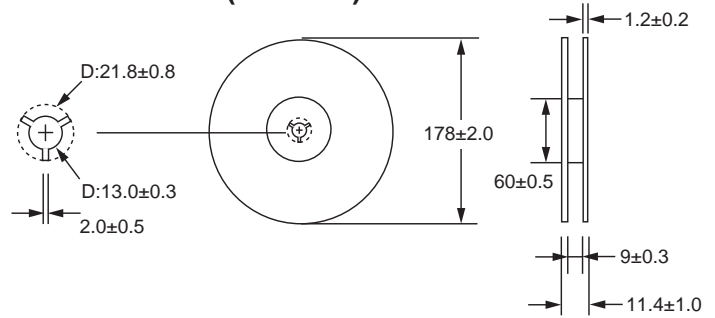

Tape Dimensions (Unit: mm)

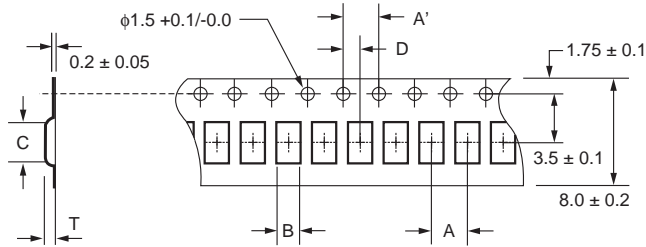

TYPE	A	A'	B	C	D	T
L-05	2.0±0.05	4.0±0.1	0.38±0.02	0.68±0.02	2.0±0.05	Max. 0.44
L-07	2.0±0.1	4.0±0.1	0.6±0.1	1.1±0.1	2.0±0.1	Max. 1.0
L-14	4.0±0.1	4.0±0.1	1.0±0.1	1.8±0.1	2.0±0.1	Max 1.3
L-15	4.0±0.1	4.0±0.1	1.6±0.1	2.4±0.1	2.0±0.1	Max 1.3

WIREWOUND INDUCTOR PACKAGING INFORMATION

Reel Dimensions

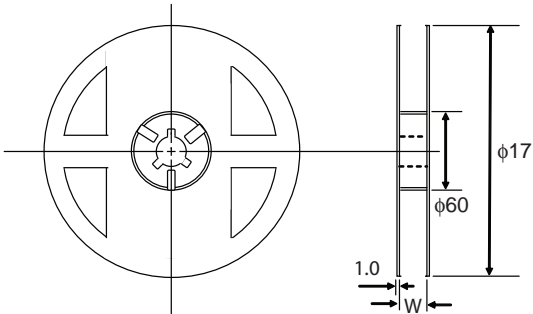

7" DIA. REEL SIZE			
TYPE / SIZE	REEL QUANTITY	TAPE TYPE	TAPE CODE
L-07 / 0402	10,000	Paper	T
L-14 / 0603	3,000	Embossed	E
L-15 / 0805	2,000	Embossed	E

Tape Dimensions

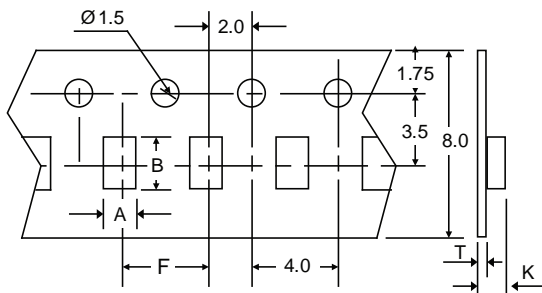

Dimensions (unit: m/m)

TYPE	A	B	F	K	T	W
L-07	0.70	1.20	2.00	-	0.70	8.00
L-14	1.25	1.80	4.00	1.10	0.20	8.00
L-15	1.42	2.26	4.00	1.30	0.20	8.00

TECHNICAL NOTES

The following technical notes are available for viewing on our website at www.johansontechnology.com/technicalnotes/

GENERAL

- RoHS Compliance
- Technical Question Form

RF CAPACITORS AND INDUCTORS

- Capacitor Mounting & S-Parameters
- Capacitor RF Current & Power
- Dishal Bandpass Filter Tuning Using LASERtrim® Chip Caps
- High Frequency Inductor Modeling Utilizing MLISoft®
- Measuring S-Parameters of High-Q Caps
- Q & ESR Explained
- Reference Oscillator Tuning Using LASERtrim® Chip Caps
- Soldering Requirements for MLCC
- S-Parameter Accuracy
- SRF & PRF for RF Capacitors
- Storage and Solderability Checklist
- Trimming Characteristics of LASERtrim® Chip Caps
- Inductor Marking and Orientation RF Study

RF COMPONENTS

- Antenna Bandwidth Expansion Guide
- Chip Antenna Layout Considerations for 802.11 Applications
- Chip Balun: Definitions & Measurement Methodology
- JTI Chip Antenna Mounting and Tuning Techniques
- Silver Leaded Components' Storage and Soldering Profile
- 2500AT43A0100 Frequency Tuning
- 2450BM14A0002 Matched Balun for the Nordic nRF24L01/nRF24L01+ Chipsets
- 2450BM15A0002 Matched Balun for T.I. 253X Family Chipsets

RF COMPONENTS

- Chip Tape & Reel Packaging
- Inductor Tape & Reel Packaging New
- RF Antenna Tape & Reel Packaging
- RF Component Tape & Reel Packaging

JOHANSON DIELECTRICS, INC.

SYLMAR, CALIFORNIA

www.johansondielectrics.com

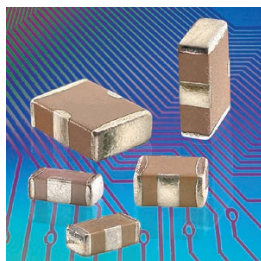

*X2Y®
EMI Filter Capacitors*



*High Voltage
Ceramic Capacitors*



*Tanceram®
Ceramic Capacitors*

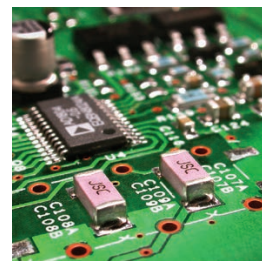

*Y1 & Y2 Safety
Certified Capacitors*

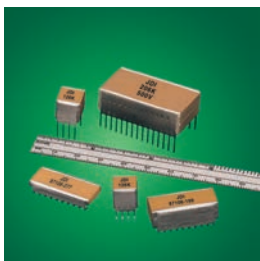

*Switchmode
Ceramic Capacitors*

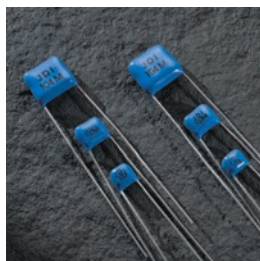

*Radial Leaded
High Voltage MLCCs*

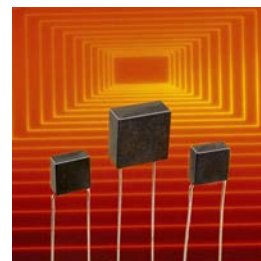

*High Temperature
Radial Leaded MLCCs*

ADVANCED MONOLYTHIC CERAMICS

OLEAN, NEW YORK

www.amccaps.com

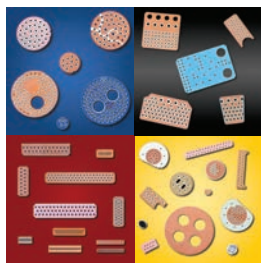

*Ceramic Planar
Array Filters*

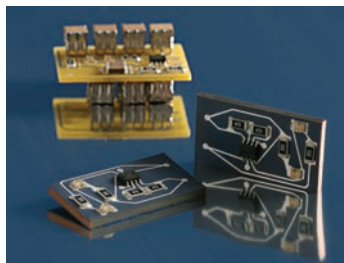

*Capstrate® Capacitor
Substrate*



Discodial EMI Capacitor



www.johansontechnology.com

Your Technology Partner

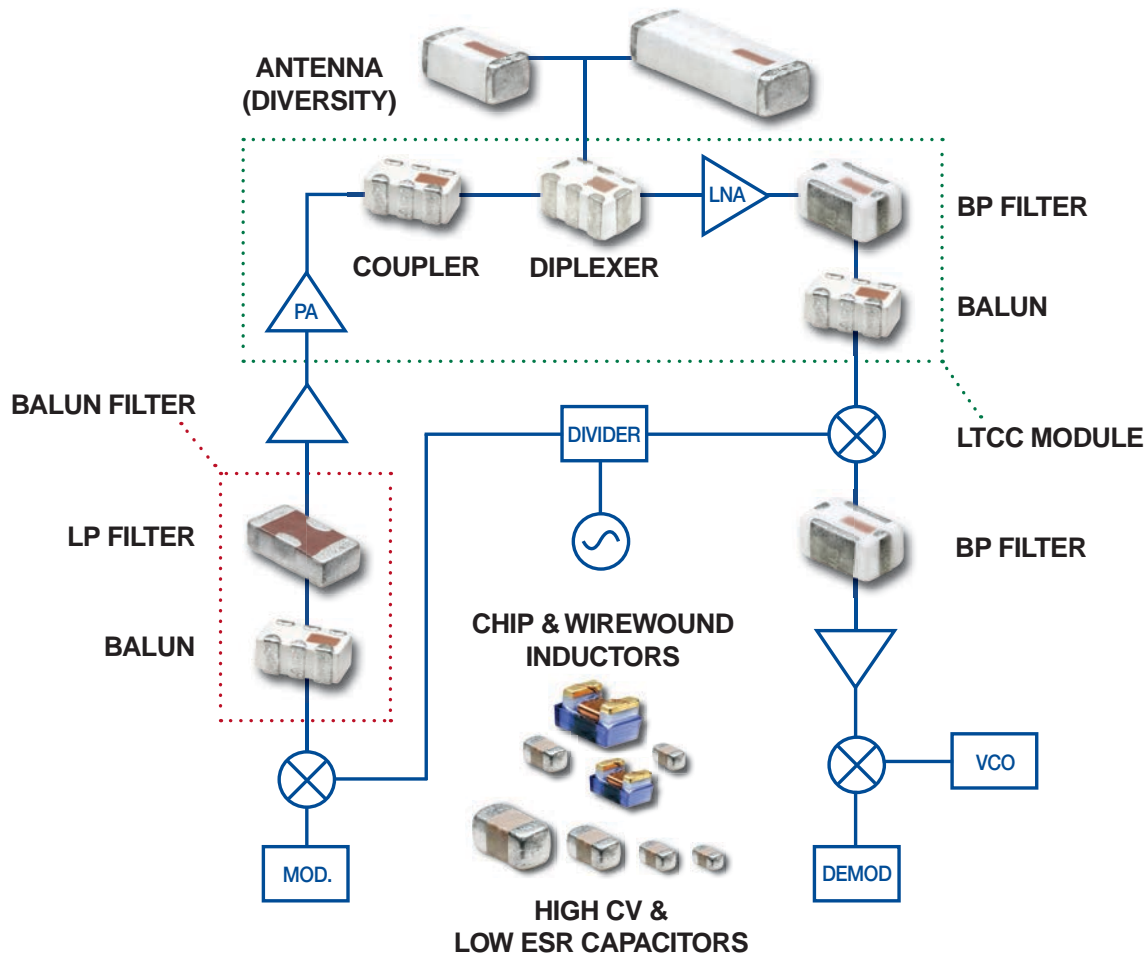

Typical Product Applications:
WiFi, WiMax, UWB, Bluetooth, Zigbee, GPS, WCDMA/GSM/GPRS & custom

JOHANSON TECHNOLOGY

EUROPE:

JOHANSON EUROPE, LTD.
Flackwell Heath,
Bucks, England HP10 9NR
TEL +44 1628 531154 • FAX +44 1628 532703
eurosales@johansontechnology.com

UNITED STATES:

HEADQUARTERS
4001 Calle Tecate,
Camarillo, California 93012
TEL (805) 389 1166 • FAX (805) 389 1821
<http://www.johansontechnology.com>

HONG KONG:

JOHANSON HONG KONG, LTD.
Unit E, 11/F., Phase 1 Kaiser Estate
41 Man Yue St., Hunghom
Kowloon, Hong Kong
TEL +852 2334 6310 • FAX +852 2334 8858
asiasales@johansontechnology.com

TAIWAN:

JOHANSON HONG KONG, LTD. TAIWAN OFFICE
9F., No.403, Sec. 4, Ren-Ai Road, Da-An District
Taipei, Taiwan (R.O.C.)
TEL +886 2 2775 3312 • FAX +886 2 2775 4832
asiasales@johansontechnology.com

SHENZHEN:

JOHANSON TRADING (SHENZHEN) CO., LTD.
Room 2303, Changping Business Building, No.99 Honghua Road,
Futian Free Trade Zone, Shenzhen, PRC 518038
TEL +86 755 8348 4609 • FAX +86 755 8348 4613
asiasales@johansontechnology.com