

THIS DOCUMENT IS THE PROPERTY OF
KEYSTONE ELECTRONICS CORP. AND
SHALL NOT BE REPRODUCED, DISTRIBUTED
OR USED AS A BASIS FOR MANUFACTURE
WITHOUT PRIOR WRITTEN PERMISSION
FROM KEYSTONE ELECTRONICS CORP.

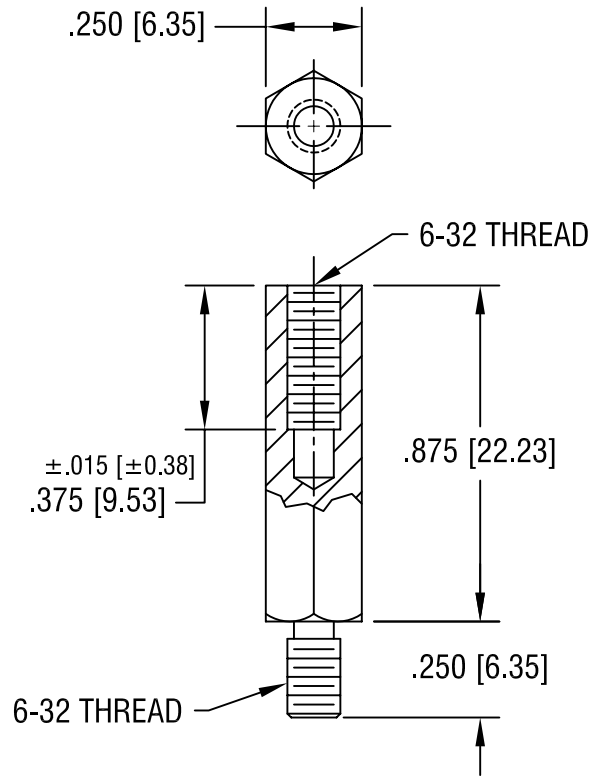

KEYSTONE ELECTRONICS CORP.

ASTORIA, N.Y. 11105-2017

PART NAME

HEX M/F STANDOFF

MATERIAL

BRASS

FINISH

NICKEL PLATE

DRN BY

BOONE

DATE

3.3.98

APP'D

LN

SCALE

2X

TOLERANCES

INCH [MM]

DECIMAL ±.005 [± 0.15]

ANGULAR ± 1°
UNLESS OTHERWISE SPECIFIED

CODE

C/M

DWG NO.

7211

DATE

DESCRIPTION

REV.