

THIS DOCUMENT IS THE PROPERTY OF
KEYSTONE ELECTRONICS CORP. AND
SHALL NOT BE REPRODUCED, DISTRIBUTED
OR USED AS A BASIS FOR MANUFACTURE
WITHOUT PRIOR WRITTEN PERMISSION
FROM KEYSTONE ELECTRONICS CORP.

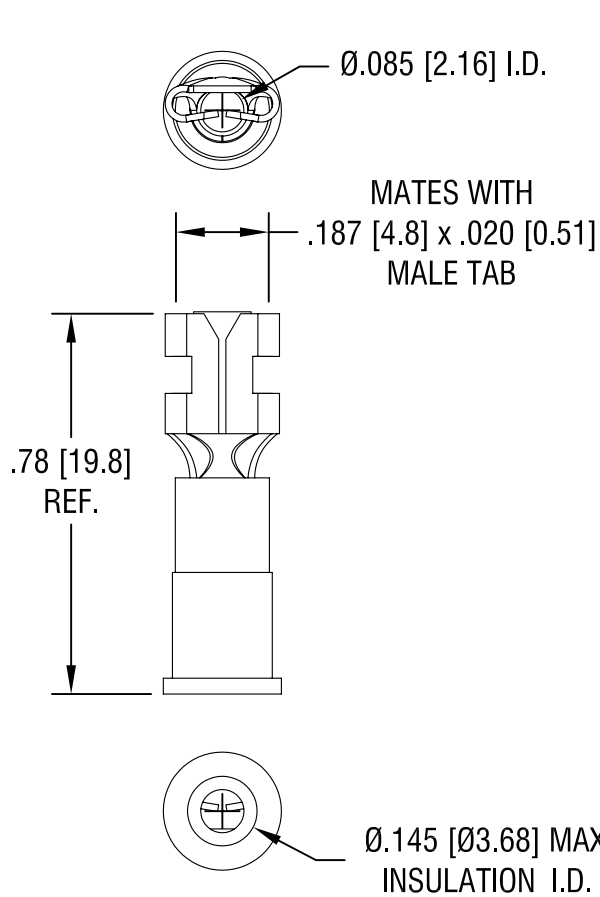

NOTE:

1. TERMINAL: COPPER, TIN PLATE
INSULATOR: VINYL, RED
2. ACCOMMODATES WIRE RANGE 22/18 AWG

KEYSTONE ELECTRONICS CORP.			
www.keyelco.com • ASTORIA, N.Y. 11105-2017 • Tel (718) 956-8900			
PART NAME			
INSULATED QUICK-FIT TERMINAL			
MATERIAL			
AS NOTED			
FINISH		DRN BY	DATE
AS NOTED		NT	8.14.08
		APP'D	SCALE
		LN	2.5X
TOLERANCES	INCH [MM]	CODE	DWG NO.
DECIMAL	± .010 [± 0.25]	C/M	8276
ANGULAR	± 1°		
UNLESS OTHERWISE SPECIFIED			

DATE	DESCRIPTION	REV.