

FRONT SHELL

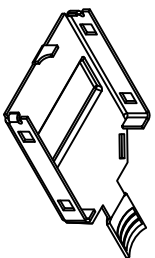

INSERTED BODY

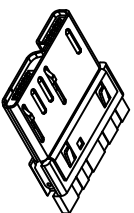

REAR SHELL

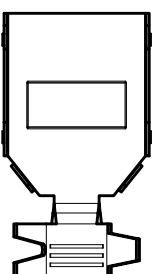
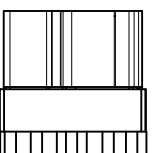
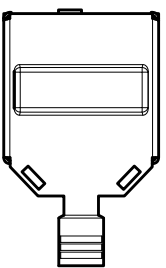
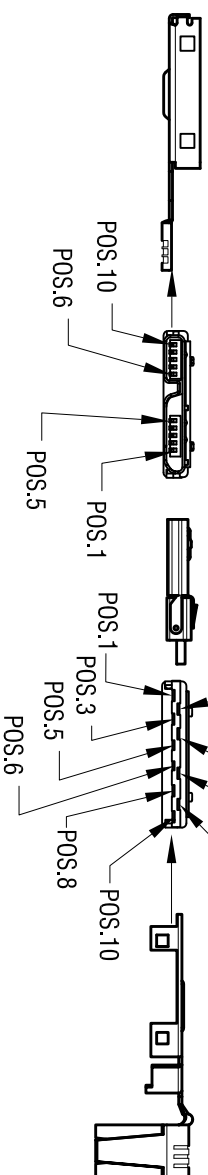
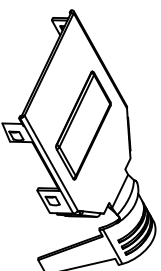

ASSEMBLED PLUG

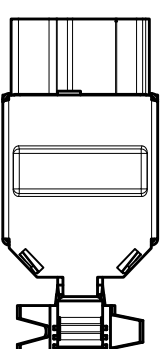
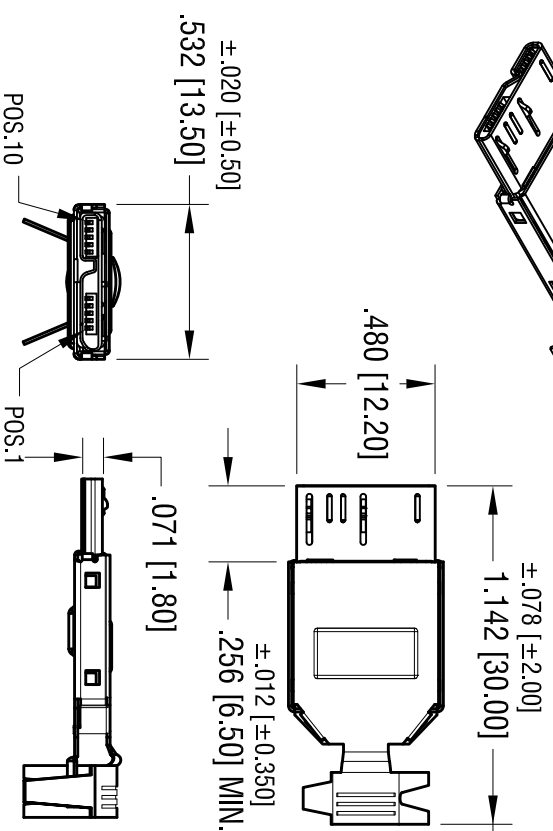
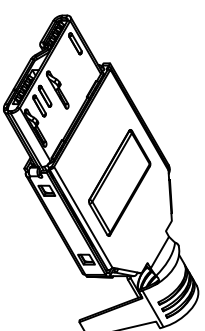

PLUG SPECIFICATIONS:

SHELL: MAT'L- STEEL

FINISH- NICKEL PLATE

CONTACT: MAT'L- PHOSPHOR BRONZE

FINISH- GOLD FLASH OVER NICKEL

INSULATION: MAT'L- THERMOPLASTIC, UL 94V-0

ELECTRICAL CHARACTERISTICS:

RATED VOLTAGE: 30V (RMS)

CONTACT CURRENT RATING: 1.8 Amp DC MAX.

CONTACT RESISTANCE: 50m Ω max.

DIELECTRIC WITHSTANDING VOLTAGE: AC 100 V.R.M.S.

MECHANICAL CHARACTERISTICS:

OPERATING TEMPERATURE: -13°F (-25°C) TO 176°F (+80°C)

DURABILITY: 1500 CYCLES MIN.

DATE	DESCRIPTION	REV.
6.01.11	CHANGE AS PER ECN 11-076	A
3.26.15	CHANGE AS PER ECN 15-040 (B1) WAS 1.008 [25.60]	B
9.01.16	CHANGE AS PER ECN 16-082 UPDATE SHELL	C

KEYSTONE ELECTRONICS CORP.
www.keystone.com • ASTORIA, N.Y. 11105-2017 • Tel (718) 956-8900

PART NAME
USB 3.0 MICRO PLUG

MATERIAL
AS NOTED

FINISH
AS NOTED

DRN BY	NT	DATE	8.11.10
App'D	LN	SCALE	1.5X

THIS DOCUMENT IS THE PROPERTY OF
KEYSTONE ELECTRONICS CORP. AND
SHALL NOT BE REPRODUCED, DISTRIBUTED
OR USED AS A BASIS FOR MANUFACTURE
WITHOUT PRIOR WRITTEN PERMISSION
FROM KEYSTONE ELECTRONICS CORP.

TOLERANCES	INCH	[MM]	CODE	DWG NO.
DECIMAL	± .010	[± 0.25]	C	957
ANGULAR	± 1°			