

THIS DOCUMENT IS THE PROPERTY OF  
KEYSTONE ELECTRONICS CORP. AND  
SHALL NOT BE REPRODUCED, DISTRIBUTED  
OR USED AS A BASIS FOR MANUFACTURE  
WITHOUT PRIOR WRITTEN PERMISSION  
FROM KEYSTONE ELECTRONICS CORP.

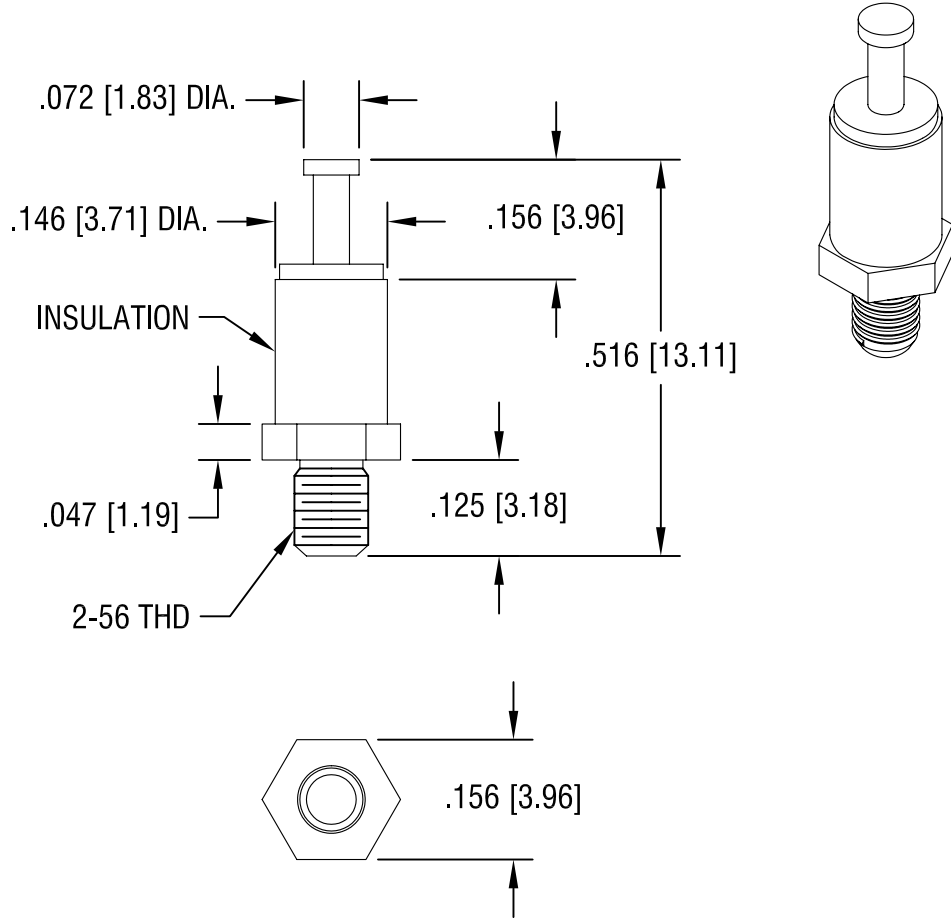

NOTES:

1. TERMINAL: MAT'L - BRASS  
FINISH: TIN
2. INSULATION: MAT'L - DIALLYL PHTHALATE  
COLOR: BLUE
3. BASE: MAT'L - BRASS  
FINISH: TIN

<b>KEYSTONE ELECTRONICS CORP.</b>			
ASTORIA, N.Y. 11105-2017			
PART NAME		INSULATED THREADED TURRETS	
MATERIAL		AS NOTED	
FINISH		DRN BY	DATE
AS NOTED		N.T.	5.03.07
		APP'D	SCALE
		LN	4X
TOLERANCES	INCH [MM]	CODE	DWG NO.
DECIMAL	± .005 [± 0.15]	C/M	<b>11500</b>
ANGULAR	± 1°		
UNLESS OTHERWISE SPECIFIED			

DATE	DESCRIPTION	REV.	
------	-------------	------	--