

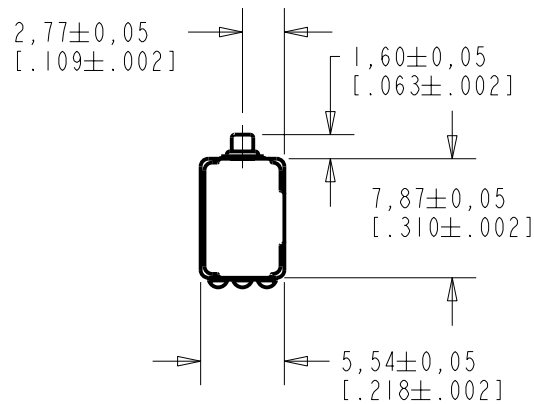

BT-21754-000
SHT 1.1



NOTE:
 LOCATED FROM TWO SURFACES FOR CUSTOMER CONVENIENCE. ONLY APPLICABLE FROM ONE SURFACE, NOT TO BE USED TOGETHER. HORIZONTAL LOCATION FOR TERMINAL CENTERED TO $\pm 0,17$ [.007].

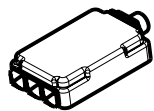
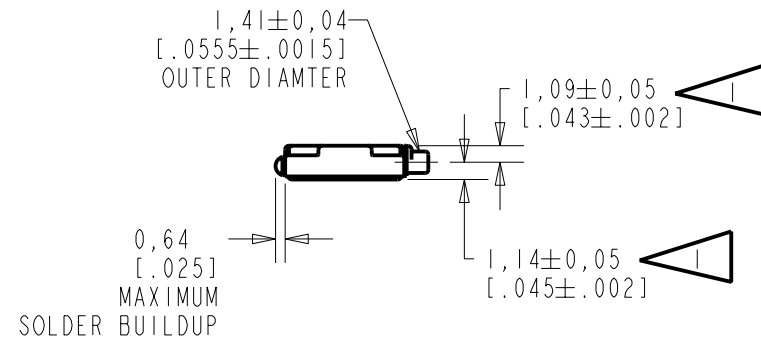
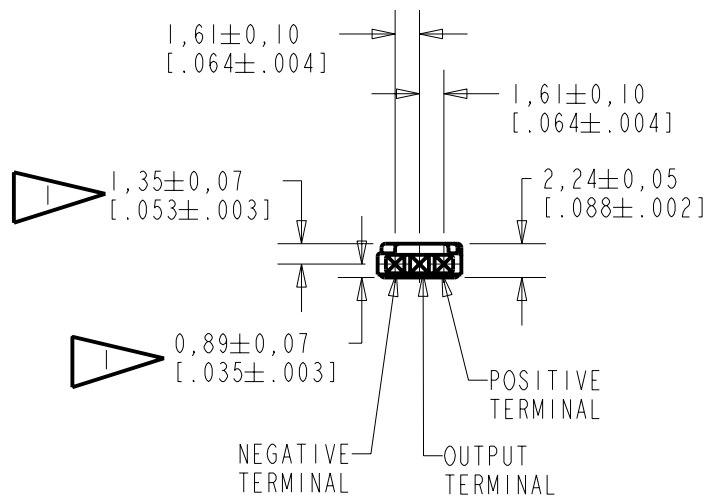

DIMENSIONS IN MILLIMETERS [INCHES]

KNOWLES ELECTRONICS
ITASCA, ILLINOIS U.S.A.

| Revision | C.O. # | Implementation Date | RELEASE LEVEL | REVISION |
|----------------------|-----------|---------------------|---------------|---------------|
| A | MI0101301 | 11-6-06 | Released | A |
| SCALE: 2:1 | | | DR. BY: MMM | DATE: 11-6-06 |
| DO NOT SCALE DRAWING | | | CK. BY: GJP | DATE: 11-9-06 |
| TITLE: MICROPHONE | | BT-21754-000 | APP. BY: GJP | DATE: 11-9-06 |
| OUTLINE DRAWING | | SHT 1.1 | | |

SENSITIVITY IN dB RELATIVE TO 1.0 VOLT/0.1 Pa (N/M²)
FOR CONDITIONS SHOWN BELOW.

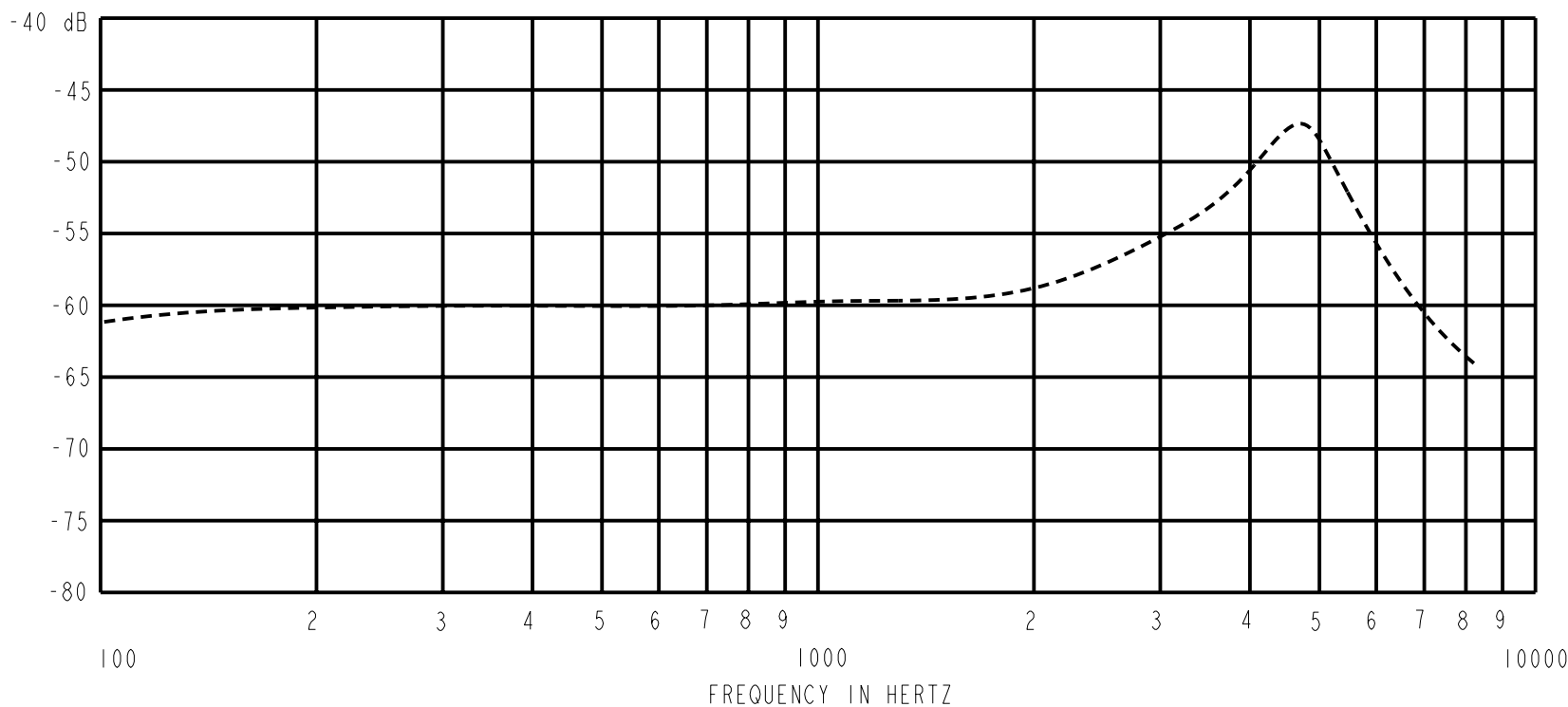

| FREQUENCY | SENSITIVITY | | | DEVICE CONFORMITY | |
|-----------|-------------|-------|-------|------------------------------|-------|
| | MIN. | NOM. | MAX. | RANGE OF DEVIATION FROM 1KHz | |
| 100 | --- | -60.5 | --- | -5.0 | 0 |
| 1000 | -62.5 | -59.5 | -56.5 | 0 | 0 |
| ≈ 4700 | --- | -48.0 | --- | +6.0 | +16.0 |

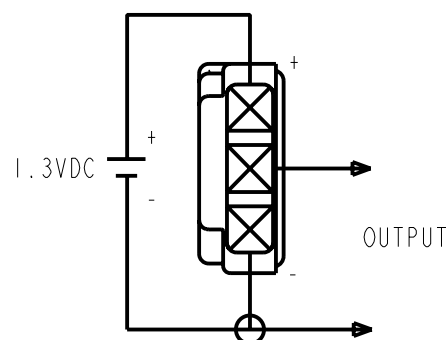

NOTES:

- CASE CONNECTED TO NEGATIVE TERMINAL.
- MICROPHONE TO BE FUNCTIONAL WITH 10 VDC SUPPLY.
- CONFORMS TO REQUIREMENTS SHOWN ON 'ELECTRET MICROPHONE ENVIRONMENTAL QUALIFICATION TEST, SHEET 2.2'.

| PORT LOCATION | DC SUPPLY | AMPLIFIER CURRENT DRAIN | SENSITIVITY CHANGE ON REDUCING SUPPLY TO 0.9VDC | "A" WEIGHTED NOISE (1 kHz EQUIV. SPL) | OUTPUT IMPEDANCE OHMS | | | CAPACITANCE ±50% | |
|---------------|-----------|-------------------------|---|---------------------------------------|-----------------------|------|------|------------------|-----|
| | | | | | MIN. | NOM. | MAX. | 1-2 | 1-3 |
| 12S | 1.3V | 40 μA MAX. | 3 dB MAX. | 27.0 dB MAX. | 2000 | 3500 | 6000 | NA | NA |

KNOWLES ELECTRONICS
ITASCA, ILLINOIS U.S.A.

| Revision | C.O. # | Implementation Date | RELEASE LEVEL | REVISION |
|----------|-----------|---------------------|---------------|----------|
| A | M10101301 | 11-6-06 | Released | A |

| | | | |
|--|--|---------|---------|
| WHEN TEST LIMITS ARE USED TO ESTABLISH INCOMING INSPECTION ACCEPTANCE/REJECTION CRITERIA, CORRELATION OF TEST EQUIPMENT WITH KNOWLES IS ALSO REQUIRED FOR ELIMINATION OF EQUIPMENT AND TEST METHOD VARIATION | | DR. BY | DATE |
| TITLE: MICROPHONE PERFORMANCE SPECIFICATION | | MMM | 11-6-06 |
| | | GJP | 11-9-06 |
| BT-21754-000 SHT 2.1 | | APP. BY | DATE |
| | | GJP | 11-9-06 |

WHEN THESE TESTS ARE USED TO ESTABLISH PRODUCT QUALIFICATION, CORRELATION OF TEST EQUIPMENT WITH KNOWLES ELECTRONICS IS ALSO REQUIRED TO ELIMINATE EQUIPMENT AND TEST METHOD VARIATION.

BECAUSE THIS IS AN ACCELERATED LIFE TEST, IT FOLLOWS THAT THE UNITS WHICH HAVE BEEN TESTED WILL NOT QUALIFY AS IN-WARRANTY RETURNS. SINCE THESE TESTS ARE DESTRUCTIVE IN NATURE, DEVICES SUBJECTED TO THESE TESTS SHOULD NOT BE USED IN PRODUCTION.

1. ACCELERATED DAMP HEAT TEST.

1.1 PRECONDITIONING:

TIME - 16 HOURS
 TEMPERATURE - 22°C ± 1°C
 HUMIDITY - 60% MAX. R.H.

1.2 TEST CONDITIONS:

TIME AT CONDITIONS: - 1000 HOURS
 TEMPERATURE - 63°C ± 1°C
 HUMIDITY - 95% R.H. ± 2%
 VOLTAGE STRESS - DETAILED FIG. 1

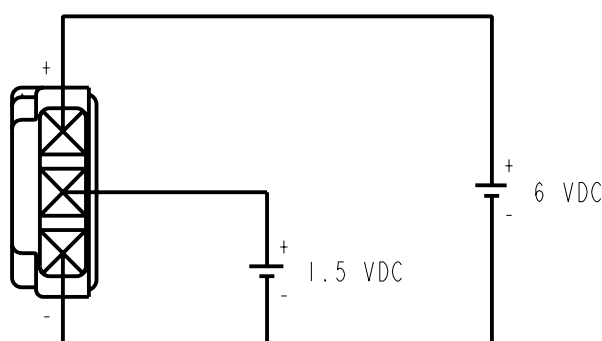

FIG. 1

(AVOID CONDENSATION FALLING ON UNITS UNDER TEST.)

1.3 INITIAL MEASUREMENTS:

AFTER PRECONDITIONING, MEASURE SENSITIVITY PER SHEET 2.1 OF THE APPLICABLE KNOWLES ELECTRONICS MICROPHONE PERFORMANCE SPECIFICATION.

1.4 TEST PROCEDURE:

INSERT UNIT(S) INTO TEST CHAMBER PER CONDITIONS OF 1.2.

1.5 RECOVERY:

TIME - 2 HOURS
 TEMPERATURE - 22°C ± 1°C
 HUMIDITY - 60% MAX. R.H.

1.6 FINAL MEASUREMENTS:

MEASURE SENSITIVITY PER CONDITIONS DESCRIBED ON SHEET 2.1.

1.7 REQUIREMENT:

NO UNITS WILL BE INOPERATIVE FOLLOWING THE TEST AND RECOVERY CYCLE.

2. SHOCK TEST

2.1 PRECONDITIONING:

TIME - 16 HOURS
 TEMPERATURE - 22°C ± 1°C
 HUMIDITY - 60% MAX. R.H.

2.2 TEST CONDITIONS:

HALF-SINE IMPULSE DURATION - 100 MICROSECONDS
 PEAK AMPLITUDE - 20,000 g

SPURIOUS DEVIATIONS IN THE HALF-SINE IMPULSE CURVE SHALL BE REDUCED TO WHERE RESULTS ARE NOT APPRECIABLY AFFECTS.

UNIT(S) TO BE SUBJECTED TO THE TEST CONDITIONS EITHER IN THE COVER UP OR COVER DOWN ORIENTATION.

2.3 INITIAL MEASUREMENTS:

AFTER PRECONDITIONING, MEASURE AND RECORD THE 1 kHz SENSITIVITY PER SHEET 2.1 OF THE APPLICABLE KNOWLES ELECTRONICS MICROPHONE PERFORMANCE SPECIFICATION.

2.4 TEST PROCEDURE:

STRESS UNIT(S) ACCORDING TO THE ABOVE 2.2 TEST CONDITIONS.

2.5 RECOVERY:

UNITS TO BE MEASURED IMMEDIATELY AFTER TEST CYCLE.

2.6 FINAL MEASUREMENTS:

MEASURE AND RECORD THE 1 kHz SENSITIVITY PER SHEET 2.1.

2.7 REQUIREMENT:

THE UNIT(S) SHALL SHOW A MAXIMUM CHANGE IN 1kHz SENSITIVITY (INITIAL TO FINAL) OF 1.0 dB AS A RESULT OF THE TEST CYCLE.

| Revision | C.O. # | Implementation Date | RELEASE LEVEL | REVISION |
|----------|-----------|---------------------|---------------|----------|
| | | | Released | A |
| A | M10101301 | 11-6-06 | | |

KNOWLES ELECTRONICS
 ITASCA, ILLINOIS U.S.A.

WHEN TEST LIMITS ARE USED TO ESTABLISH INCOMING INSPECTION ACCEPTANCE/REJECTION CRITERIA, CORRELATION OF TEST EQUIPMENT WITH KNOWLES IS ALSO REQUIRED FOR ELIMINATION OF EQUIPMENT AND TEST METHOD VARIATION

TITLE: **MICROPHONE**
 PERFORMANCE SPECIFICATION

BT-21754-000
 SHT 2.2

| DR. BY | DATE |
|---------|---------|
| MMM | 11-6-06 |
| CK. BY | DATE |
| GJP | 11-9-06 |
| APP. BY | DATE |
| GJP | 11-9-06 |