

Jacks

163-4021, 163-4025

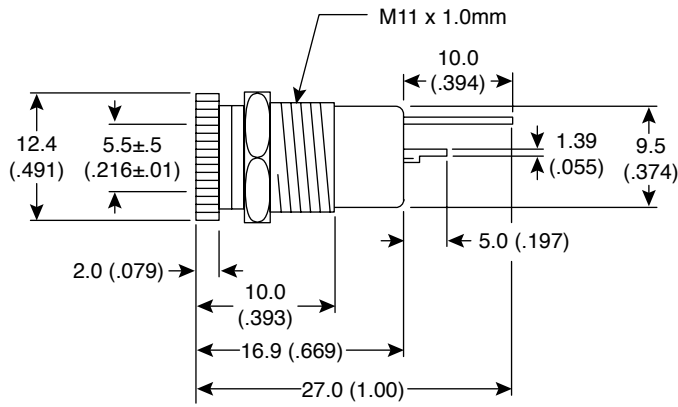

Jacks

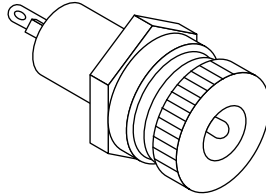

DIMENSIONS: mm (in.)
(except where noted)

SPECIFICATIONS	
Type:	Chassis mount DC power w/solder lugs
Rating:	100VDC 2A
Insulation resistance:	50MΩ Min. @ 100VDC
Contact resistance:	30mΩ Max.
Dielectric strength:	250VAC for 1 minute
"L" lug, contact pin, nut, body:	Nickel plated brass
Spring:	Nickel plated phosphor bronze
Insulator:	Delrin
Mounting hole:	ø.445±.028"
Pin size:	ø2.1±0.2mm (163-4021), ø2.4±0.2mm (163-4025)
Max panel thickness:	5mm

Date Last Revised: 4/12/16

Available from Mouser Electronics
1-800-346-6873
www.mouser.com

KC-300372

163-4021, 163-4025