

High Luminous Efficacy  
Cool White LED Emitter

# LZ4-00CW00



## Key Features

- High Luminous Efficacy 10W Cool White LED
- Ultra-small foot print – 7.0mm x 7.0mm
- Surface mount ceramic package with integrated glass lens
- Very low Thermal Resistance (1.1°C/W)
- Individually addressable die
- Electrically neutral thermal path
- Very high Luminous Flux density
- Spatial color uniformity across radiation pattern
- JEDEC Level 1 for Moisture Sensitivity Level
- Autoclave complaint (JEDEC JESD22-A102-C)
- Lead (Pb) free and RoHS compliant
- Reflow solderable (up to 6 cycles)
- Emitter available on Standard or Serially connected MCPCB (optional)

## Typical Applications

- Architectural lighting
- Street lighting
- Stage and Studio lighting
- Task and Accent lighting
- Refrigeration lighting
- Portable lighting

## Description

The LZ4-00CW00 Cool White LED emitter provides 10W power in an extremely small package. With a 7.0mm x 7.0mm ultra-small footprint, this package provides exceptional luminous flux density. LED Engin's patent-pending thermally insulated phosphor layer provides spatial color uniformity across the radiation pattern and a consistent CCT over time and temperature. LED Engin's LZ4-00CW00 LED offers ultimate design flexibility with individually addressable die. The high quality materials used in the package are chosen to optimize light output and minimize stresses which results in monumental reliability and lumen maintenance. The robust product design thrives in outdoor applications with high ambient temperatures and high humidity.

**Base part number**

Part number	Description
LZ4-00CW00-xxxx	LZ4 emitter
LZ4-40CW00-xxxx	LZ4 emitter on Standard Star 1 channel MCPCB

**Bin kit option codes**

<b>CW, Cool White (5000K – 6500K)</b>			
Kit number suffix	Min flux Bin	Chromaticity bins	Description
0000	U	1U, 1A, 1B, 1V, 1Y, 1D, 1C, 1X, 2U, 2A, 2B, 2V, 2Y, 2D, 2C, 2X, 3U, 3A, 3B, 3V, 3Y, 3D, 3C, 3X	full distribution flux; full distribution CCT
0050	U	2Y, 2D, 2C, 2X, 3U, 3A, 3B, 3V, 3Y, 3D, 3C, 3X	full distribution flux; 5000K bin
0055	U	2U, 2Y, 3U, 2A, 2D, 3A, 2B, 2C, 3B, 2V, 2X, 3V	full distribution flux; 5500K bin
0056	U	1Y, 1D, 1C, 1X, 2U, 2A, 2B, 2V, 2Y, 2D, 2C, 2X	full distribution flux; 5600K bin
0065	U	1U, 1A, 1B, 1V, 1Y, 1D, 1C, 1X, 2U, 2A, 2B, 2V	full distribution flux; 6500K bin

**Notes:**

1. Default bin kit option is -0000

### Cool White Chromaticity Groups

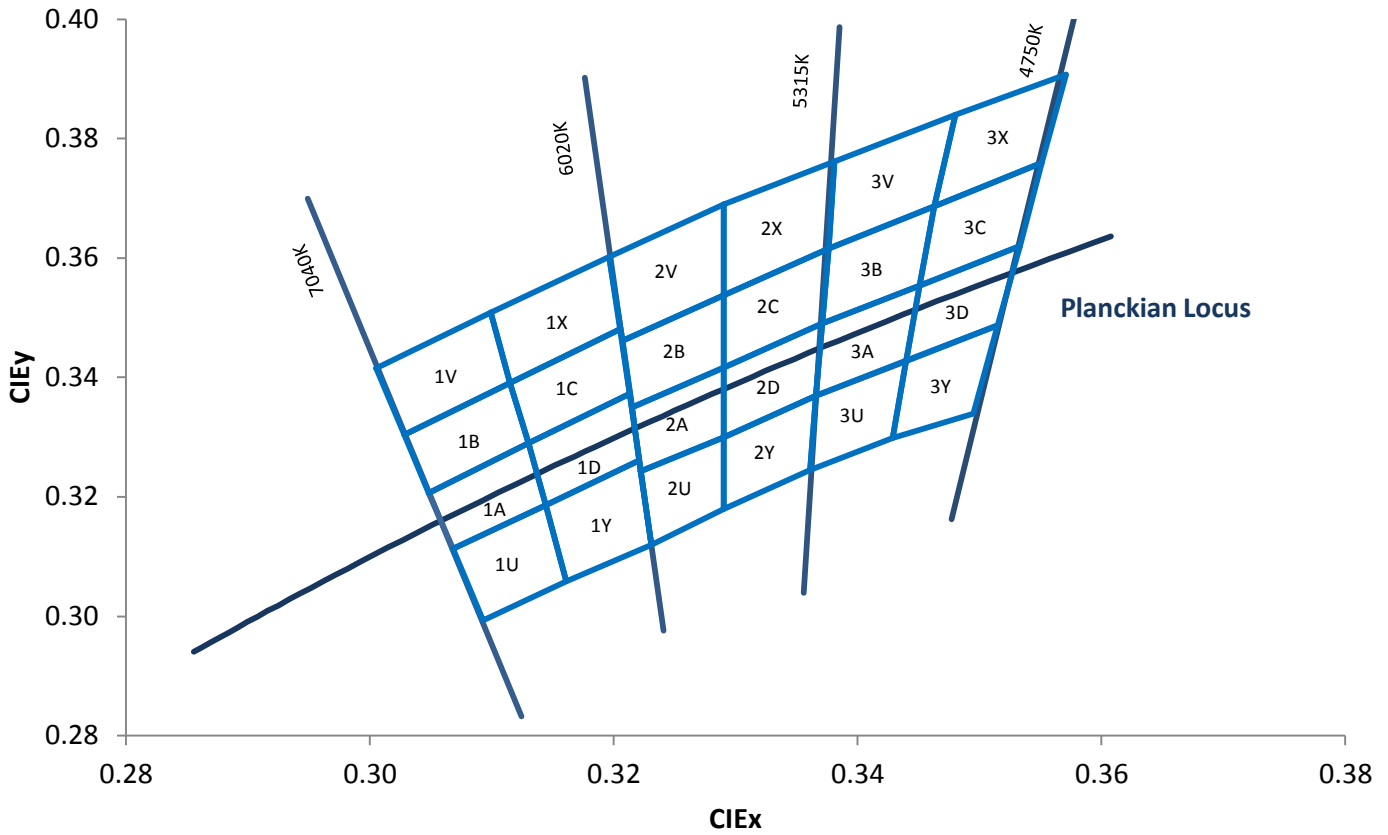

Standard Chromaticity Groups plotted on excerpt from the CIE 1931 (2°) x-y Chromaticity Diagram. Coordinates are listed below in the table.

## Cool White Bin Coordinates

Bin code	CIE <sub>x</sub>	CIE <sub>y</sub>	Bin code	CIE <sub>x</sub>	CIE <sub>y</sub>	Bin code	CIE <sub>x</sub>	CIE <sub>y</sub>	Bin code	CIE <sub>x</sub>	CIE <sub>y</sub>
1U	0.3068	0.3113	1A	0.3048	0.3207	1B	0.3028	0.3304	1V	0.3005	0.3415
	0.3144	0.3186		0.313	0.329		0.3115	0.3391		0.3099	0.3509
	0.3161	0.3059		0.3144	0.3186		0.313	0.329		0.3115	0.3391
	0.3093	0.2993		0.3068	0.3113		0.3048	0.3207		0.3028	0.3304
	0.3068	0.3113		0.3048	0.3207		0.3028	0.3304		0.3005	0.3415
1Y	0.3144	0.3186	1D	0.313	0.329	1C	0.3115	0.3391	1X	0.3099	0.3509
	0.3221	0.3261		0.3213	0.3373		0.3205	0.3481		0.3196	0.3602
	0.3231	0.312		0.3221	0.3261		0.3213	0.3373		0.3205	0.3481
	0.3161	0.3059		0.3144	0.3186		0.313	0.329		0.3115	0.3391
	0.3144	0.3186		0.313	0.329		0.3115	0.3391		0.3099	0.3509
2U	0.3222	0.3243	2A	0.3215	0.335	2B	0.3207	0.3462	2V	0.3196	0.3602
	0.329	0.33		0.329	0.3417		0.329	0.3538		0.329	0.369
	0.329	0.318		0.329	0.33		0.329	0.3417		0.329	0.3538
	0.3231	0.312		0.3222	0.3243		0.3215	0.335		0.3207	0.3462
	0.3222	0.3243		0.3215	0.335		0.3207	0.3462		0.3196	0.3602
2Y	0.329	0.33	2D	0.329	0.3417	2C	0.329	0.3538	2X	0.329	0.369
	0.3366	0.3369		0.3371	0.349		0.3376	0.3616		0.3381	0.3762
	0.3361	0.3245		0.3366	0.3369		0.3371	0.349		0.3376	0.3616
	0.329	0.318		0.329	0.33		0.329	0.3417		0.329	0.3538
	0.329	0.33		0.329	0.3417		0.329	0.3538		0.329	0.369
3U	0.3366	0.3369	3A	0.3371	0.349	3B	0.3376	0.3616	3V	0.3381	0.3762
	0.344	0.3428		0.3451	0.3554		0.3463	0.3687		0.348	0.384
	0.3429	0.3299		0.344	0.3427		0.3451	0.3554		0.3463	0.3687
	0.3361	0.3245		0.3366	0.3369		0.3371	0.349		0.3376	0.3616
	0.3366	0.3369		0.3371	0.349		0.3376	0.3616		0.3381	0.3762
3Y	0.344	0.3428	3D	0.3451	0.3554	3C	0.3463	0.3687	3X	0.348	0.384
	0.3515	0.3487		0.3533	0.362		0.3551	0.376		0.3571	0.3907
	0.3495	0.3339		0.3515	0.3487		0.3533	0.362		0.3551	0.376
	0.3429	0.3299		0.344	0.3427		0.3451	0.3554		0.3463	0.3687
	0.344	0.3428		0.3451	0.3554		0.3463	0.3687		0.348	0.384

## Luminous Flux Bins

Table 1:

<b>Bin Code</b>	<b>Minimum Luminous Flux (<math>\Phi_v</math>) @ <math>I_F = 700\text{mA}</math><sup>[1,2]</sup> (lm)</b>	<b>Maximum Luminous Flux (<math>\Phi_v</math>) @ <math>I_F = 700\text{mA}</math><sup>[1,2]</sup> (lm)</b>	<b>Typical Luminous Flux (<math>\Phi_v</math>) @ <math>I_F = 1000\text{mA}</math><sup>[2]</sup> (lm)</b>
U	556	695	810
V	695	868	1010

Notes for Table 1:

1. Luminous flux performance guaranteed within published operating conditions. LED Engin maintains a tolerance of  $\pm 10\%$  on flux measurements.
2. Future products will have even higher levels of luminous flux performance. Contact LED Engin Sales for updated information.

## Forward Voltage Bins

Table 2:

<b>Bin Code</b>	<b>Minimum Forward Voltage (<math>V_F</math>) @ <math>I_F = 700\text{mA}</math><sup>[1,2]</sup> (V)</b>	<b>Maximum Forward Voltage (<math>V_F</math>) @ <math>I_F = 700\text{mA}</math><sup>[1,2]</sup> (V)</b>
0	12.80	16.64

Notes for Table 2:

1. Forward Voltage is binned with all four LED dice connected in series.
2. LED Engin maintains a tolerance of  $\pm 0.4\text{V}$  for forward voltage measurements for the four LEDs.

## Absolute Maximum Ratings

Table 3:

Parameter	Symbol	Value	Unit
DC Forward Current at $T_{jmax}=135^{\circ}\text{C}$ <sup>[1]</sup>	$I_F$	1200	mA
DC Forward Current at $T_{jmax}=150^{\circ}\text{C}$ <sup>[1]</sup>	$I_F$	1000	mA
Peak Pulsed Forward Current <sup>[2]</sup>	$I_{FP}$	2000	mA
Reverse Voltage	$V_R$	See Note 3	V
Storage Temperature	$T_{stg}$	-40 ~ +150	$^{\circ}\text{C}$
Junction Temperature	$T_J$	150	$^{\circ}\text{C}$
Soldering Temperature <sup>[4]</sup>	$T_{sol}$	260	$^{\circ}\text{C}$
Allowable Reflow Cycles		6	
Autoclave Conditions <sup>[5]</sup>		121 $^{\circ}\text{C}$ at 2 ATM, 100% RH for 168 hours	
ESD Sensitivity <sup>[6]</sup>		> 8,000 V HBM Class 3B JESD22-A114-D	

Notes for Table 3:

- Maximum DC forward current (per die) is determined by the overall thermal resistance and ambient temperature. Follow the curves in Figure 10 for current derating.
- Pulse forward current conditions: Pulse Width  $\leq$  10msec and Duty cycle  $\leq$  10%.
- LEDs are not designed to be reverse biased.
- Solder conditions per JEDEC 020D. See Reflow Soldering Profile Figure 5.
- Autoclave Conditions per JEDEC JESD22-A102-C.
- LED Engin recommends taking reasonable precautions towards possible ESD damages and handling the LZ4-00CW00 in an electrostatic protected area (EPA). An EPA may be adequately protected by ESD controls as outlined in ANSI/ESD S6.1.

## Optical Characteristics @ $T_C = 25^{\circ}\text{C}$

Table 4:

Parameter	Symbol	Typical	Unit
Luminous Flux (@ $I_F = 700\text{mA}$ ) <sup>[1]</sup>	$\Phi_V$	680	lm
Luminous Flux (@ $I_F = 1000\text{mA}$ ) <sup>[1]</sup>	$\Phi_V$	850	lm
Luminous Efficacy (@ $I_F = 350\text{mA}$ )		90	lm/W
Correlated Color Temperature	CCT	5500	K
Color Rendering Index (CRI)	$R_a$	75	
Viewing Angle <sup>[2]</sup>	$2\Theta_{1/2}$	105	Degrees
Total Included Angle <sup>[3]</sup>	$\Theta_{0.9V}$	135	Degrees

Notes for Table 4:

- Luminous flux typical value is for all four LED dice operating concurrently at rated current.
- Viewing Angle is the off axis angle from emitter centerline where the luminous intensity is  $\frac{1}{2}$  of the peak value.
- Total Included Angle is the total angle that includes 90% of the total luminous flux.

## Electrical Characteristics @ $T_C = 25^{\circ}\text{C}$

Table 5:

Parameter	Symbol	Typical	Unit
Forward Voltage (@ $I_F = 700\text{mA}$ ) <sup>[1]</sup>	$V_F$	14.0	V
Forward Voltage (@ $I_F = 1000\text{mA}$ ) <sup>[1]</sup>	$V_F$	14.6	V
Temperature Coefficient of Forward Voltage <sup>[1]</sup>	$\Delta V_F/\Delta T_J$	-11.9	mV/ $^{\circ}\text{C}$
Thermal Resistance (Junction to Case)	$R\Theta_{J-C}$	1.1	$^{\circ}\text{C}/\text{W}$

Notes for Table 5:

- Forward Voltage typical value is for all four LED dice connected in series.

## IPC/JEDEC Moisture Sensitivity Level

Table 6 - IPC/JEDEC J-STD-20D.1 MSL Classification:

Level	Floor Life		Soak Requirements			
	Time	Conditions	Standard	Accelerated	Standard	Accelerated
	Time	Conditions	Time (hrs)	Conditions	Time (hrs)	Conditions
1	Unlimited	≤ 30°C/ 85% RH	168 +5/-0	85°C/ 85% RH	n/a	n/a

Notes for Table 6:

- The standard soak time includes a default value of 24 hours for semiconductor manufacturer's exposure time (MET) between bake and bag and includes the maximum time allowed out of the bag at the distributor's facility.

## Average Lumen Maintenance Projections

Lumen maintenance generally describes the ability of a lamp to retain its output over time. The useful lifetime for solid state lighting devices (Power LEDs) is also defined as Lumen Maintenance, with the percentage of the original light output remaining at a defined time period.

Based on long-term WHTOL testing, LED Engin projects that the LZ Series will deliver, on average, 90% Lumen Maintenance at 65,000 hours of operation at a forward current of 700 mA per die. This projection is based on constant current operation with junction temperature maintained at or below 125°C.





### Recommended Solder Mask Layout (mm)

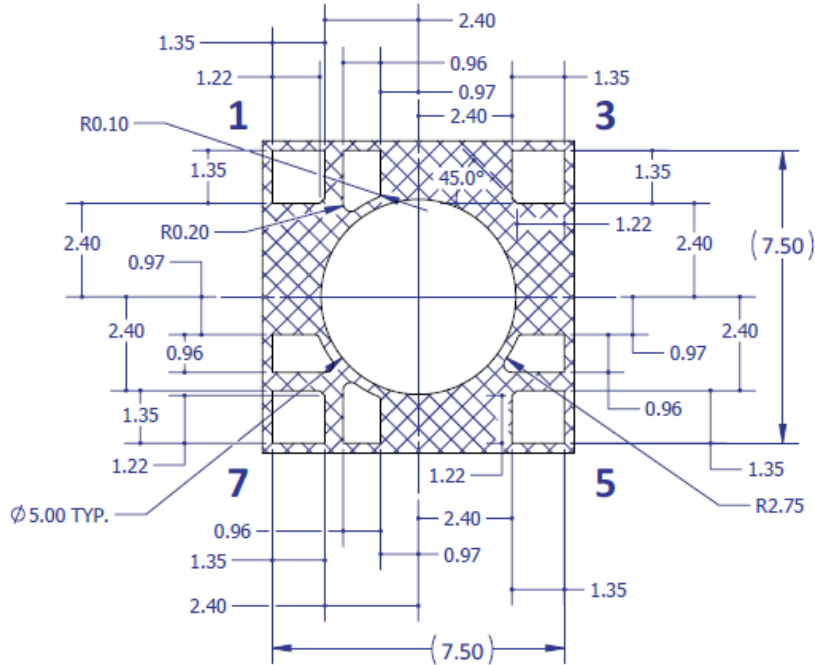

Figure 2b: Recommended solder mask opening (hatched area) for anode, cathode, and thermal pad.

Note for Figure 2b:

1. Unless otherwise noted, the tolerance =  $\pm 0.20$  mm.

### Reflow Soldering Profile

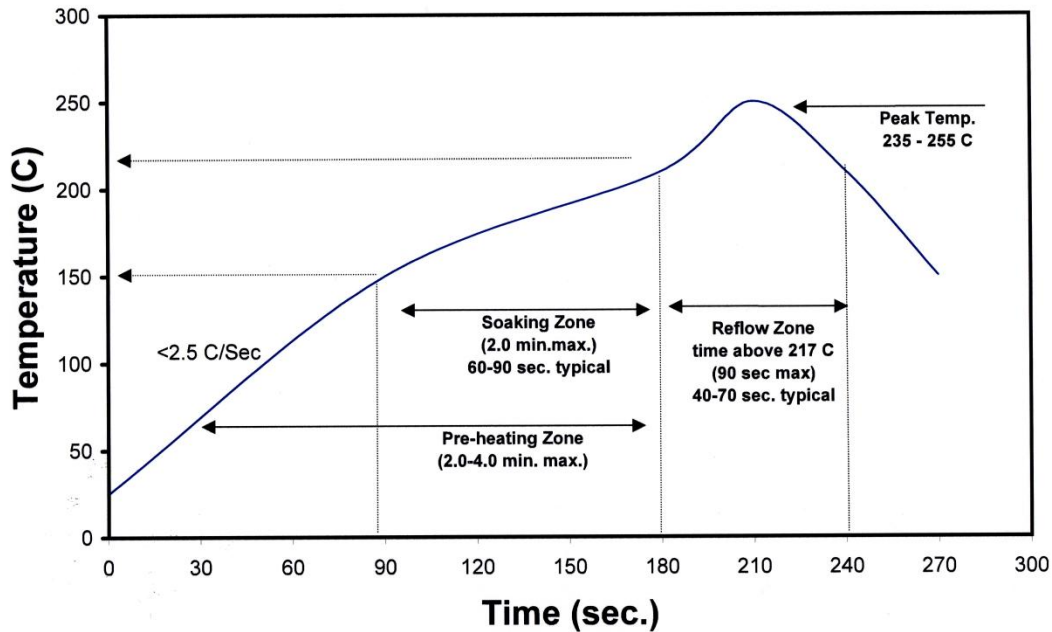

Figure 3: Reflow soldering profile for lead free soldering.

### Typical Radiation Pattern

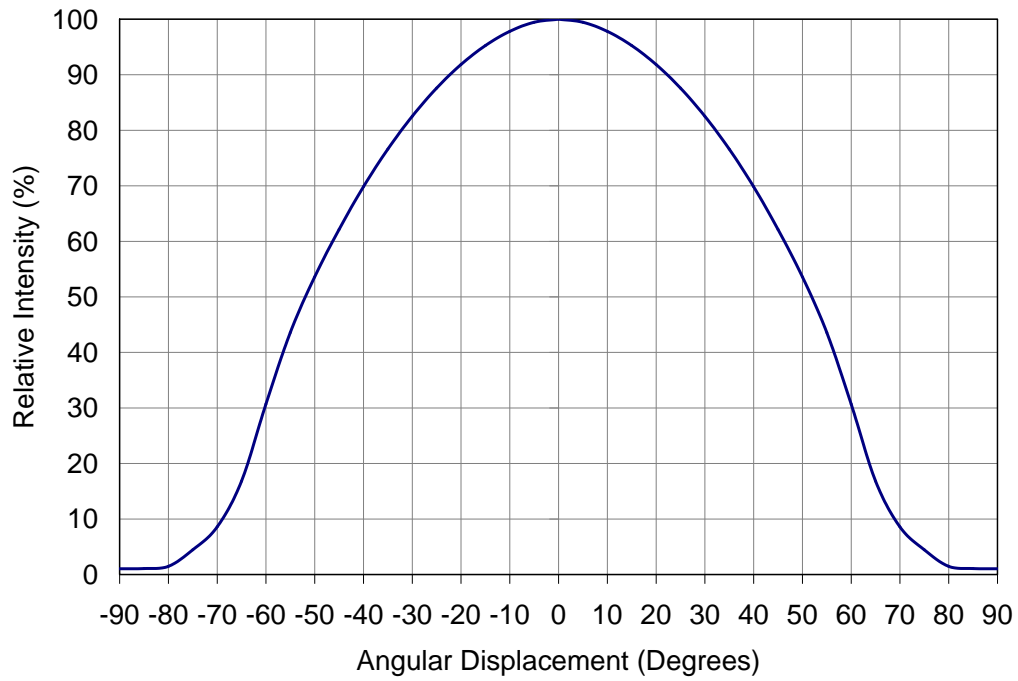

Figure 4: Typical representative spatial radiation pattern.

### Typical Relative Spectral Power Distribution

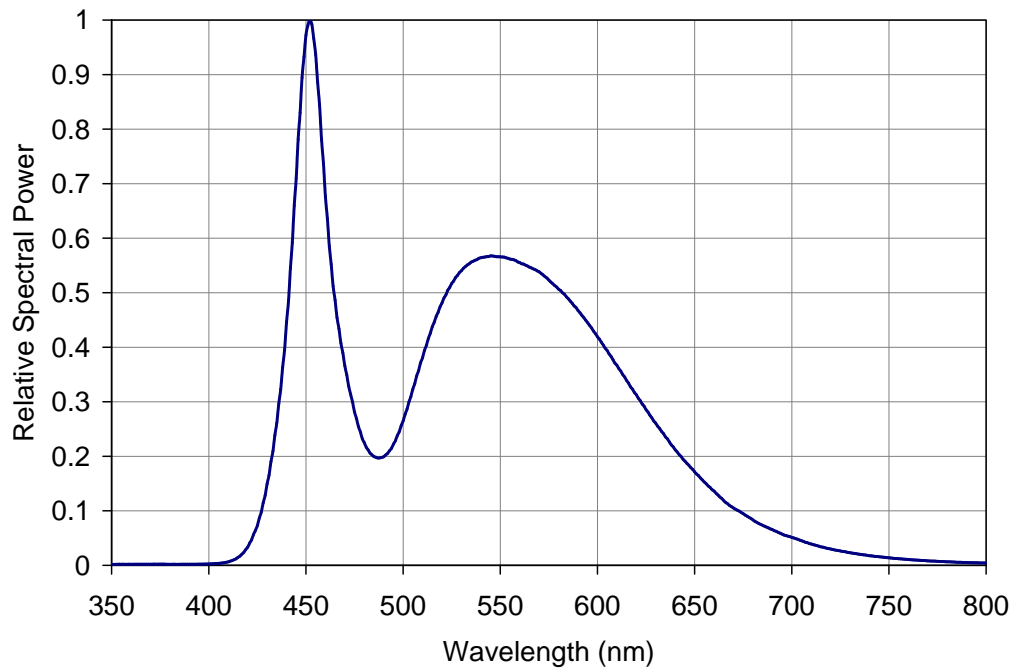

Figure 5: Typical relative spectral power vs. wavelength @ T<sub>c</sub> = 25°C.

### Typical Relative Light Output

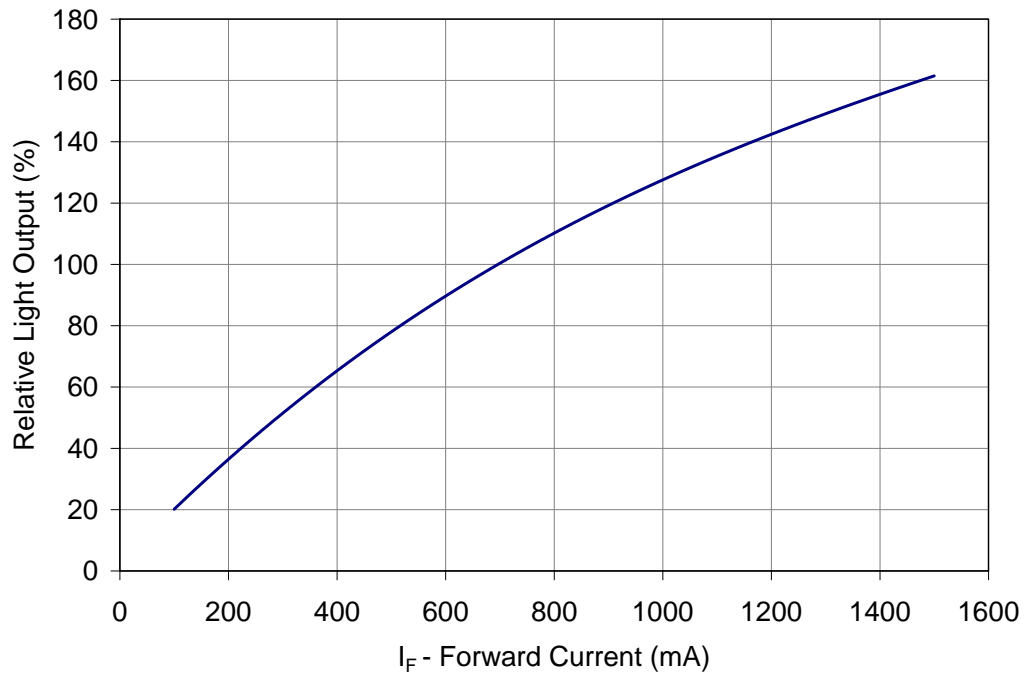

Figure 6: Typical relative light output vs. forward current @  $T_c = 25^\circ\text{C}$ .

### Typical Relative Light Output over Temperature

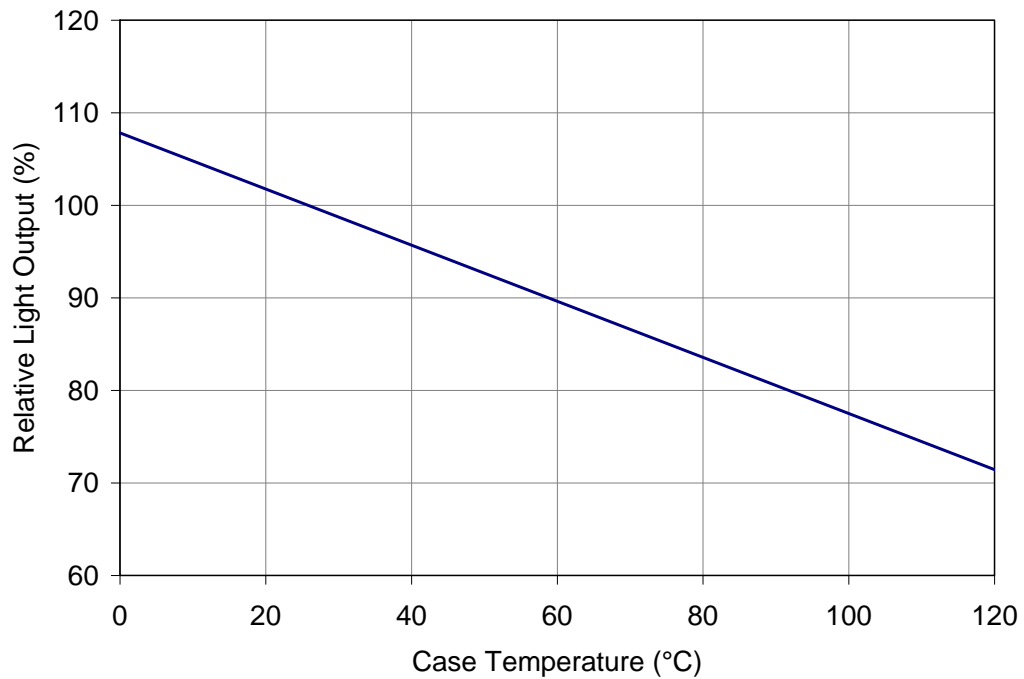

Figure 7: Typical relative light output vs. case temperature.

## Typical Forward Current Characteristics

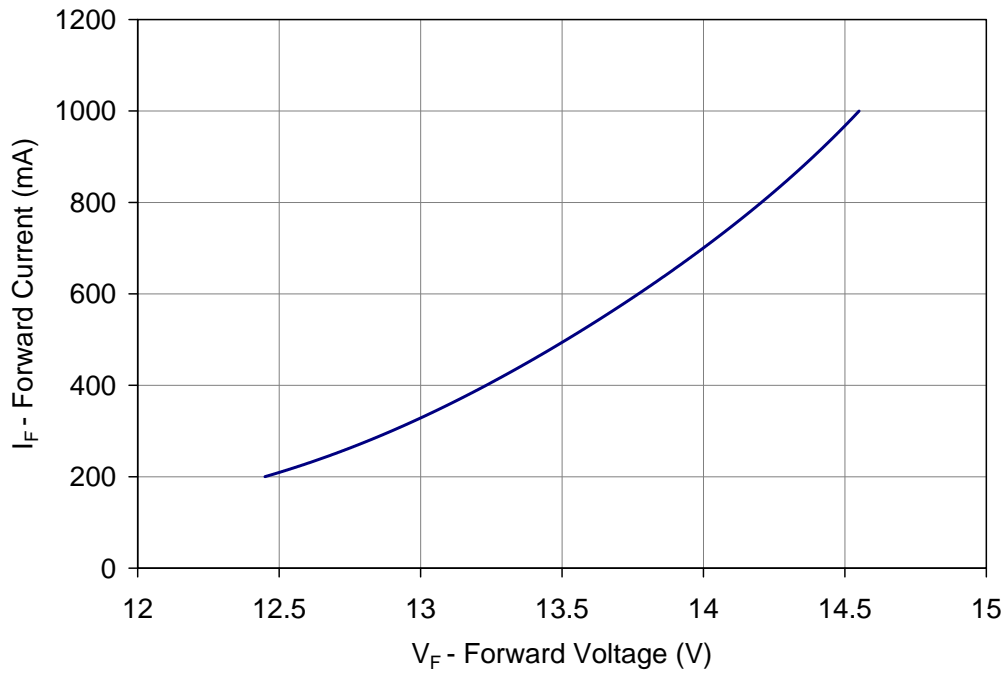

Figure 8: Typical forward current vs. forward voltage @  $T_C = 25^\circ\text{C}$ .

Note for Figure 8:

1. Forward Voltage curve assumes that all four LED dice are connected in series.

## Current De-rating

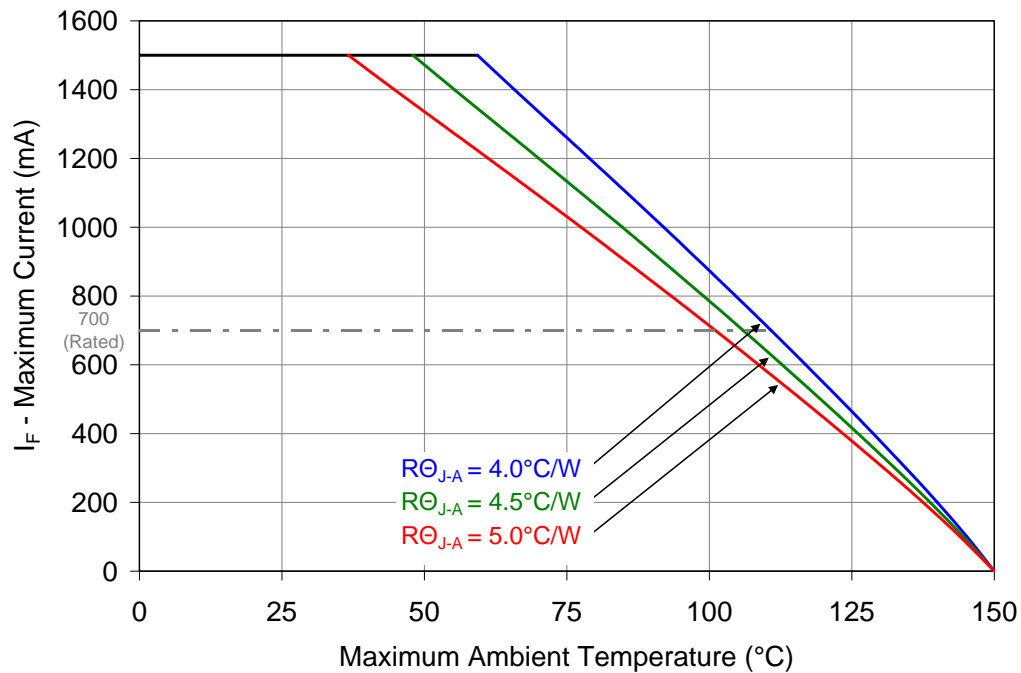

Figure 9: Maximum forward current vs. ambient temperature based on  $T_{j(\text{MAX})} = 150^\circ\text{C}$ .

Notes for Figure 9:

1. Maximum current assumes that all four LED dice are operating concurrently at the same current.
2.  $R_{\theta JC}$  [Junction to Case Thermal Resistance] for the LZ4-00CW00 is typically  $1.1^\circ\text{C/W}$ .
3.  $R_{\theta JA}$  [Junction to Ambient Thermal Resistance] =  $R_{\theta JC} + R_{\theta CA}$  [Case to Ambient Thermal Resistance].

### Emitter Tape and Reel Specifications (mm)

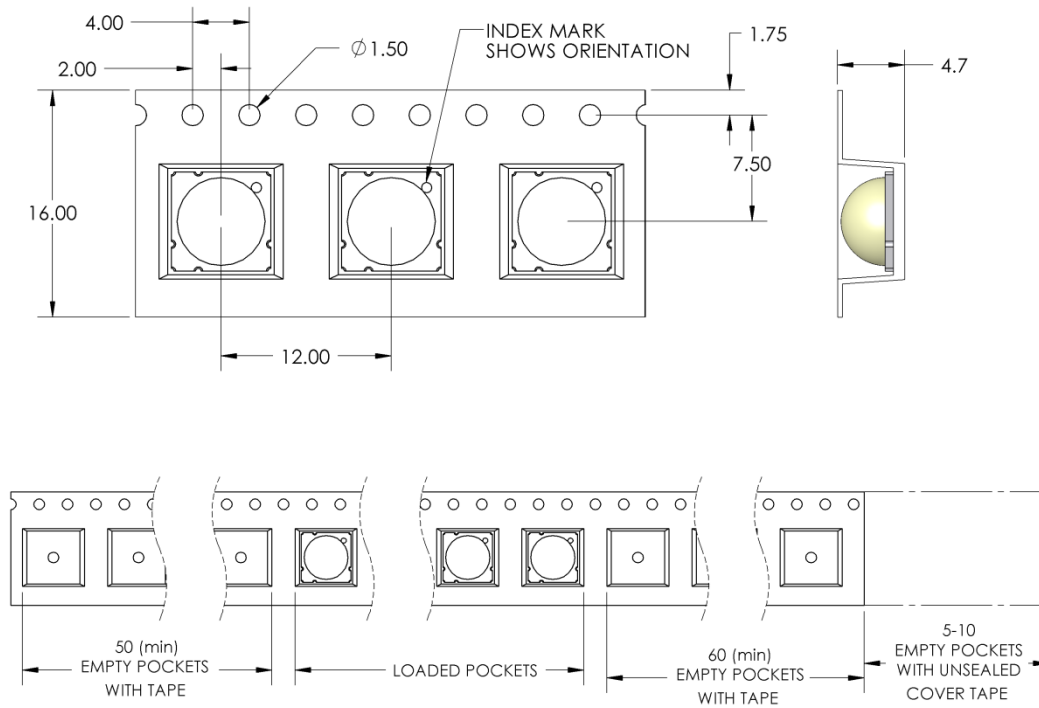

Figure 10: Emitter carrier tape specifications (mm).

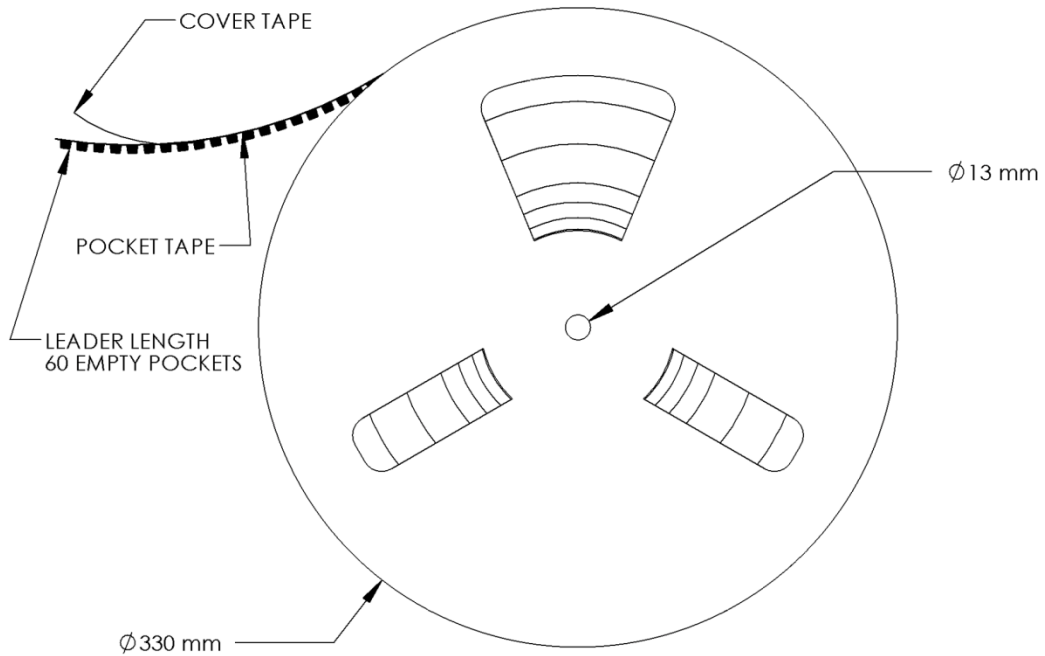

Figure 11: Emitter Reel specifications (mm).

# LZ4 MCPCB Family

Part number	Type of MCPCB	Diameter (mm)	Emitter + MCPCB Thermal Resistance (°C/W)	Typical $V_f$ (V)	Typical $I_f$ (mA)
LZ4-4xxxxxx	1-channel	19.9	1.1 + 1.1 = 2.2	14.0	700

## Mechanical Mounting of MCPCB

- MCPCB bending should be avoided as it will cause mechanical stress on the emitter, which could lead to substrate cracking and subsequently LED dies cracking.
- To avoid MCPCB bending:
  - Special attention needs to be paid to the flatness of the heat sink surface and the torque on the screws.
  - Care must be taken when securing the board to the heat sink. This can be done by tightening three M3 screws (or #4-40) in steps and not all the way through at once. Using fewer than three screws will increase the likelihood of board bending.
  - It is recommended to always use plastics washers in combinations with the three screws.
  - If non-taped holes are used with self-tapping screws, it is advised to back out the screws slightly after tightening (with controlled torque) and then re-tighten the screws again.

## Thermal interface material

- To properly transfer heat from LED emitter to heat sink, a thermally conductive material is required when mounting the MCPCB on to the heat sink.
- There are several varieties of such material: thermal paste, thermal pads, phase change materials and thermal epoxies. An example of such material is Electrolube EHTC.
- It is critical to verify the material's thermal resistance to be sufficient for the selected emitter and its operating conditions.

## Wire soldering

- To ease soldering wire to MCPCB process, it is advised to preheat the MCPCB on a hot plate of 125-150°C. Subsequently, apply the solder and additional heat from the solder iron will initiate a good solder reflow. It is recommended to use a solder iron of more than 60W.
- It is advised to use lead-free, no-clean solder. For example: SN-96.5 AG-3.0 CU 0.5 #58/275 from Kester (pn: 24-7068-7601)

# LZ4-4xxxxx

## 1 channel, Standard Star MCPCB (1x4) Dimensions (mm)

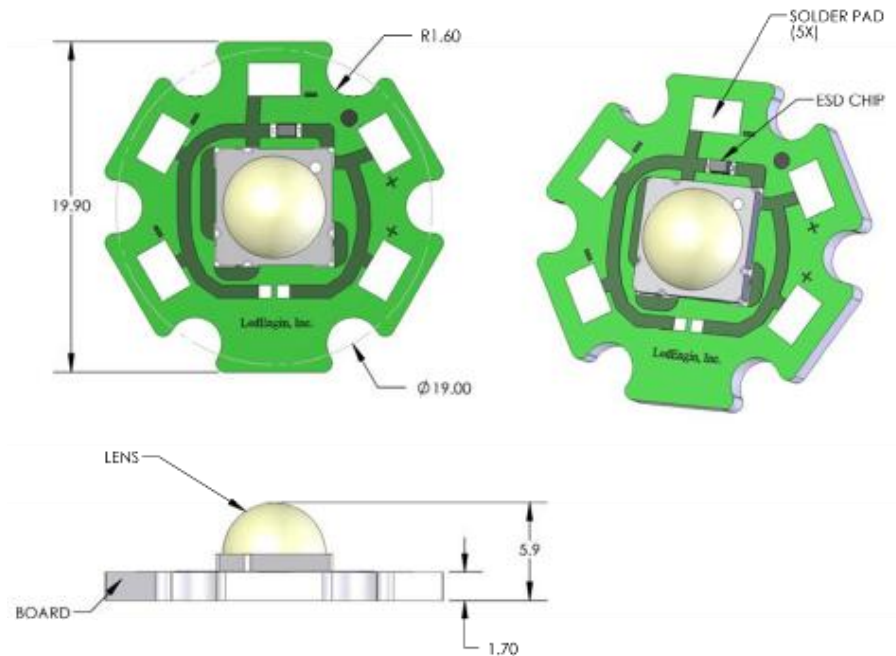

**Notes:**

- Unless otherwise noted, the tolerance =  $\pm 0.2$  mm.
- Slots in MCPCB are for M3 or #4-40 mounting screws.
- LED Engin recommends plastic washers to electrically insulate screws from solder pads and electrical traces.
- Electrical connection pads on MCPCB are labeled "+" for Anode and "-" for Cathode
- LED Engin recommends thermal interface material when attaching the MCPCB to a heatsink
- The thermal resistance of the MCPCB is: R $\theta$ C-B 1.1°C/W

## Components used

MCPCB: HT04503 (Bergquist)  
 ESD chips: BZX585-C30 (NXP, for 4 LED dies in series)

Pad layout			
Ch.	MCPCB Pad	String/die	Function
1	-	1/ABCD	Cathode -
	+		Anode +

## Company Information

LED Engin, based in California's Silicon Valley, develops, manufactures, and sells advanced LED emitters, optics and light engines to create uncompromised lighting experiences for a wide range of entertainment, architectural, general lighting and specialty applications. LuxiGen™ multi-die emitter and secondary lens combinations reliably deliver industry-leading flux density, upwards of 5000 quality lumens to a target, in a wide spectrum of colors including whites, tunable whites, multi-color and UV LEDs in a unique patented compact ceramic package. Our LuxiTune™ series of tunable white lighting modules leverage our LuxiGen emitters and lenses to deliver quality, control, freedom and high density tunable white light solutions for a broad range of new recessed and downlighting applications. The small size, yet remarkably powerful beam output and superior in-source color mixing, allows for a previously unobtainable freedom of design wherever high-flux density, directional light is required.

LED Engin is committed to providing products that conserve natural resources and reduce greenhouse emissions.

LED Engin reserves the right to make changes to improve performance without notice.

Please contact [sales@ledengin.com](mailto:sales@ledengin.com) or (408) 922-7200 for more information.