

OptoTEC™ Series OT20,31,F1,0808 Thermoelectric Module

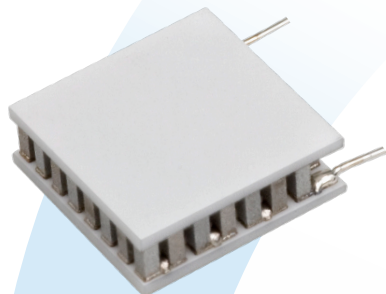

The OptoTEC™ Series is a miniature thermoelectric module (TEM). This product series is primarily used in applications to stabilize the temperature of sensitive optical components in telecom and photonics industries.

This product line is available in multiple configurations and surface finishing options. Assembled with Bismuth Telluride semiconductor material and thermally conductive Aluminum Oxide ceramics, the OptoTEC™ Series is designed for lower current and lower heat-pumping applications. Custom designs are available to accommodate metallization, pretinning, ceramic patterns, and solder posts, however MOQ applies.

FEATURES

- Miniature geometric sizes
- Precise temperature control
- Reliable solid state operation
- No sound or vibration
- DC operation
- RoHS compliant

APPLICATIONS

- Laser diodes
- CCD cameras
- Infrared (IR) sensors
- Pump lasers
- Crystal oscillators
- Optical transceivers

PERFORMANCE SPECIFICATIONS

Hot side temperature (°C)	25	50
Qmax (watts)	4.2	4.7
Delta Tmax (°C)	67	77
I _{max} (amps)	2.0	2.0
V _{max} (volts)	3.5	4.0
Module resistance (ohms)	1.62	1.82

SUFFIX	THICKNESS (PRIOR TO TINNING)	FLATNESS & PARALLELISM	HOT FACE	COLD FACE	LEAD LENGTH
11	0.086" +/- 0.002"	0.002" / 0.002"	Lapped	Lapped	2.0"
TB	0.086" +/- 0.0005"	0.0005" / 0.0005"	Lapped	Lapped	2.0"
00	0.100" +/- 0.005"	NA / NA	Metallized	Metallized	2.0"
22	0.100" +/- 0.005"	NA / NA	Pre-tinned	Pre-tinned	2.0"
GG	0.100" +/- 0.005"	NA / NA	Au Plated	Au Plated	2.0"

SEALING OPTION

SUFFIX	SEALANT	COLOR	TEMP RANGE	DESCRIPTION
RT	RTV	White	-60 to 204 °C	Non-corrosive, silicone adhesive sealant
EP	Epoxy	Black	-55 to 150 °C	Low density syntactic foam epoxy encapsulant

global solutions: local support™

Americas: +1 888.246.9050

Europe: +46.31.704.67.57

Asia: +86.755.2714.1166

clv.customerpos@lairdtech.com

www.lairdtech.com

PERFORMANCE CURVES

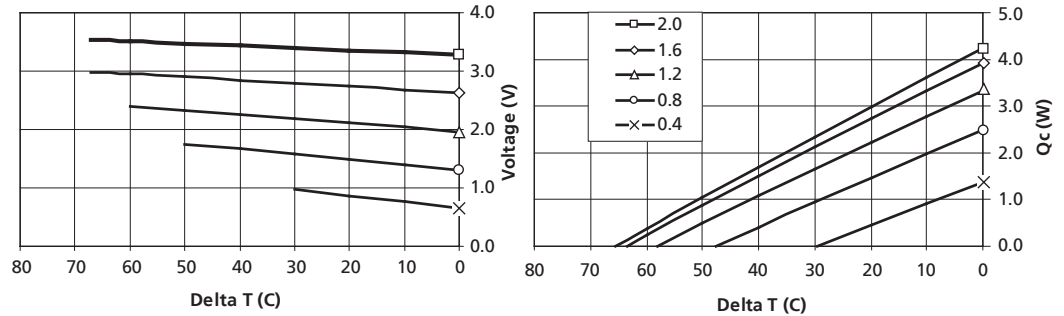

MECHANICAL DRAWING

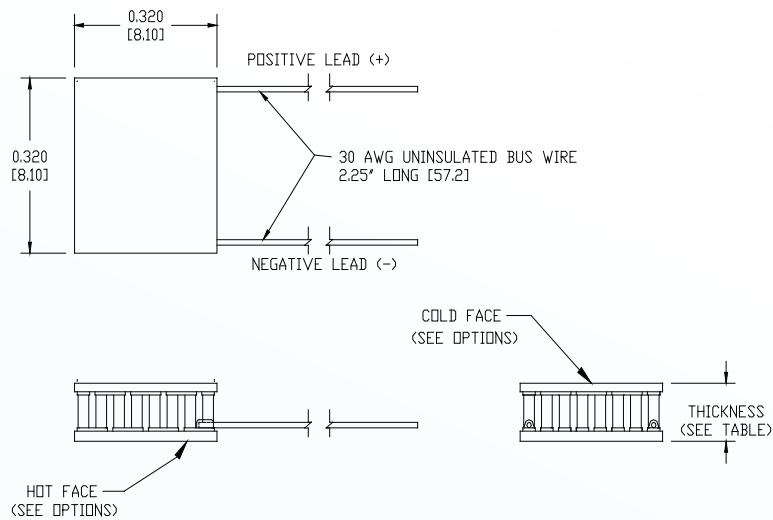

Ceramic Material 96% Alumina Ceramics
Solder Construction: 138°C BiSn

OPERATING TIPS

- Max operating temperature: 80°C
- Do not exceed I_{max} or V_{max} when operating module
- Reference assembly guidelines for recommended installation
- Solder tinning also available on metallized ceramics

THR-DS-OT20,31,F1,0808,11,W2.25 0809

Any information furnished by Laird Technologies, Inc. and its agents is believed to be accurate and reliable. All specifications are subject to change without notice. Responsibility for the use and application of Laird Technologies materials rests with the end user, since Laird Technologies and its agents cannot be aware of all potential uses. Laird Technologies makes no warranties as to the fitness, merchantability or suitability of any Laird Technologies materials or products for any specific or general uses. Laird Technologies shall not be liable for incidental or consequential damages of any kind. All Laird Technologies products are sold pursuant to the Laird Technologies' Terms and Conditions of sale in effect from time to time, a copy of which will be furnished upon request. © Copyright 2009 Laird Technologies, Inc. All Rights Reserved. Laird, Laird Technologies, the Laird Technologies Logo, and other marks are trade marks or registered trade marks of Laird Technologies, Inc. or an affiliate company thereof. Other product or service names may be the property of third parties. Nothing herein provides a license under any Laird Technologies or any third party intellectual property rights.