



## Mach<sup>®</sup> 4 CPLD Device Datasheet

June 2010

# Select Devices Discontinued!

Product Change Notifications (PCNs) have been issued to convert or discontinue select devices in this data sheet.

The original datasheet pages have not been modified and do not reflect those changes. Please refer to the table below for reference PCN and current product status.

| Product Line    | Ordering Part Number | Product Status    | Reference PCN   |
|-----------------|----------------------|-------------------|---|
| <b>M4-32/32</b> | M4-32/32-7JC         | Converted to M4A5 | Contact<br><a href="mailto:pcn@latticesemi.com">pcn@latticesemi.com</a><br>for more info. |
|                 | M4-32/32-10JC        |                   |   |
|                 | M4-32/32-12JC        |                   |   |
|                 | M4-32/32-15JC        |                   |   |
|                 | M4-32/32-10JI        |                   |   |
|                 | M4-32/32-12JI        |                   |   |
|                 | M4-32/32-14JI        |                   |   |
|                 | M4-32/32-18JI        |                   |   |
|                 | M4-32/32-7VC         |                   |   |
|                 | M4-32/32-10VC        |                   |   |
|                 | M4-32/32-12VC        |                   |   |
|                 | M4-32/32-15VC        |                   |   |
|                 | M4-32/32-10VI        |                   |   |
|                 | M4-32/32-12VI        |                   |   |
|                 | M4-32/32-14VI        |                   |   |
|                 | M4-32/32-18VI        |                   |   |
|                 | M4-32/32-7VC48       |                   |   |
|                 | M4-32/32-10VC48      |                   |   |
|                 | M4-32/32-12VC48      |                   |   |
|                 | M4-32/32-15VC48      |                   |   |
| M4-32/32-10VI48 |                      |                   |   |
| M4-32/32-12VI48 |                      |                   |   |
| M4-32/32-14VI48 |                      |                   |   |
| M4-32/32-18VI48 |                      |                   |   |



| Product Line     | Ordering Part Number | Product Status    | Reference PCN   |
|------------------|----------------------|-------------------|---|
| <b>M4-64/32</b>  | M4-64/32-7JC         | Converted to M4A5 | Contact <a href="mailto:pcn@latticesemi.com">pcn@latticesemi.com</a> for more info. |
|                  | M4-64/32-10JC        |                   |   |
|                  | M4-64/32-12JC        |                   |   |
|                  | M4-64/32-15JC        |                   |   |
|                  | M4-64/32-10JI        |                   |   |
|                  | M4-64/32-12JI        |                   |   |
|                  | M4-64/32-14JI        |                   |   |
|                  | M4-64/32-18JI        |                   |   |
|                  | M4-64/32-7VC         |                   |   |
|                  | M4-64/32-10VC        |                   |   |
|                  | M4-64/32-12VC        |                   |   |
|                  | M4-64/32-15VC        |                   |   |
|                  | M4-64/32-10VI        |                   |   |
|                  | M4-64/32-12VI        |                   |   |
|                  | M4-64/32-14VI        |                   |   |
|                  | M4-64/32-18VI        |                   |   |
|                  | M4-64/32-7VC48       |                   |   |
|                  | M4-64/32-10VC48      |                   |   |
|                  | M4-64/32-12VC48      |                   |   |
|                  | M4-64/32-15VC48      |                   |   |
| M4-64/32-10VI48  |                      |                   |   |
| M4-64/32-12VI48  |                      |                   |   |
| M4-64/32-14VI48  |                      |                   |   |
| M4-64/32-18VI48  |                      |                   |   |
| <b>M4-96/48</b>  | M4-96/48-7VC         | Convert to M4A5   | Contact <a href="mailto:pcn@latticesemi.com">pcn@latticesemi.com</a> for more info. |
|                  | M4-96/48-10VC        |                   |   |
|                  | M4-96/48-12VC        |                   |   |
|                  | M4-96/48-15VC        |                   |   |
|                  | M4-96/48-10VI        |                   |   |
|                  | M4-96/48-12VI        |                   |   |
|                  | M4-96/48-14VI        |                   |   |
|                  | M4-96/48-18VI        |                   |   |
| <b>M4-128/64</b> | M4-128/64-7YC        | Convert to M4A5   | Contact <a href="mailto:pcn@latticesemi.com">pcn@latticesemi.com</a> for more info. |
|                  | M4-128/64-10YC       |                   |   |
|                  | M4-128/64-12YC       |                   |   |
|                  | M4-128/64-15YC       |                   |   |
|                  | M4-128/64-10YI       |                   |   |
|                  | M4-128/64-12YI       |                   |   |
|                  | M4-128/64-14YI       |                   |   |
| M4-128/64-18YI   |                      |                   |   |



| Product Line                  | Ordering Part Number | Product Status     | Reference PCN   |
|-------------------------------|----------------------|--------------------|---|
| <b>M4-128/64<br/>(Cont'd)</b> | M4-128/64-7VC        | Convert to M4A5    | Contact<br><a href="mailto:pcn@latticesemi.com">pcn@latticesemi.com</a><br>for more info. |
|                               | M4-128/64-10VC       |                    |   |
|                               | M4-128/64-12VC       |                    |   |
|                               | M4-128/64-15VC       |                    |   |
|                               | M4-128/64-10VI       |                    |   |
|                               | M4-128/64-12VI       |                    |   |
|                               | M4-128/64-14VI       |                    |   |
|                               | M4-128/64-18VI       |                    |   |
| <b>M4-128N/64</b>             | M4-128N/64-7JC       | Active / Orderable |   |
|                               | M4-128N/64-10JC      |                    |   |
|                               | M4-128N/64-12JC      |                    |   |
|                               | M4-128N/64-15JC      |                    |   |
|                               | M4-128N/64-10JI      |                    |   |
|                               | M4-128N/64-12JI      |                    |   |
|                               | M4-128N/64-14JI      |                    |   |
|                               | M4-128N/64-18JI      |                    |   |
| <b>M4-192/96</b>              | M4-192/96-7VC        | Convert to M4A5    | Contact<br><a href="mailto:pcn@latticesemi.com">pcn@latticesemi.com</a><br>for more info. |
|                               | M4-192/96-10VC       |                    |   |
|                               | M4-192/96-12VC       |                    |   |
|                               | M4-192/96-15VC       |                    |   |
|                               | M4-192/96-10VI       |                    |   |
|                               | M4-192/96-12VI       |                    |   |
|                               | M4-192/96-14VI       |                    |   |
|                               | M4-192/96-18VI       |                    |   |
| <b>M4-256/128</b>             | M4-256/128-7YC       | Convert to M4A5    | Contact<br><a href="mailto:pcn@latticesemi.com">pcn@latticesemi.com</a><br>for more info. |
|                               | M4-256/128-10YC      |                    |   |
|                               | M4-256/128-12YC      |                    |   |
|                               | M4-256/128-15YC      |                    |   |
|                               | M4-256/128-10YI      |                    |   |
|                               | M4-256/128-12YI      |                    |   |
|                               | M4-256/128-14YI      |                    |   |
|                               | M4-256/128-18YI      |                    |   |
| <b>M4LV-32/32</b>             | M4LV-32/32-7JC       | Convert to M4A3    | Contact<br><a href="mailto:pcn@latticesemi.com">pcn@latticesemi.com</a><br>for more info. |
|                               | M4LV-32/32-10JC      |                    |   |
|                               | M4LV-32/32-12JC      |                    |   |
|                               | M4LV-32/32-15JC      |                    |   |
|                               | M4LV-32/32-10JI      |                    |   |
|                               | M4LV-32/32-12JI      |                    |   |
|                               | M4LV-32/32-14JI      |                    |   |
|                               | M4LV-32/32-18JI      |                    |   |



| Product Line                   | Ordering Part Number | Product Status  | Reference PCN   |
|--------------------------------|----------------------|-----------------|---|
| <b>M4LV-32/32<br/>(Cont'd)</b> | M4LV-32/32-7VC       | Convert to M4A3 | Contact<br><a href="mailto:pcn@latticesemi.com">pcn@latticesemi.com</a><br>for more info. |
|                                | M4LV-32/32-10VC      |                 |   |
|                                | M4LV-32/32-12VC      |                 |   |
|                                | M4LV-32/32-15VC      |                 |   |
|                                | M4LV-32/32-10VI      |                 |   |
|                                | M4LV-32/32-12VI      |                 |   |
|                                | M4LV-32/32-14VI      |                 |   |
|                                | M4LV-32/32-18VI      |                 |   |
|                                | M4LV-32/32-7VC48     |                 |   |
|                                | M4LV-32/32-10VC48    |                 |   |
|                                | M4LV-32/32-12VC48    |                 |   |
|                                | M4LV-32/32-15VC48    |                 |   |
|                                | M4LV-32/32-10VI48    |                 |   |
|                                | M4LV-32/32-12VI48    |                 |   |
| M4LV-32/32-14VI48              |                      |                 |   |
| M4LV-32/32-18VI48              |                      |                 |   |
| <b>M4LV-64/32</b>              | M4LV-64/32-7JC       | Convert to M4A3 | Contact<br><a href="mailto:pcn@latticesemi.com">pcn@latticesemi.com</a><br>for more info. |
|                                | M4LV-64/32-10JC      |                 |   |
|                                | M4LV-64/32-12JC      |                 |   |
|                                | M4LV-64/32-15JC      |                 |   |
|                                | M4LV-64/32-10JI      |                 |   |
|                                | M4LV-64/32-12JI      |                 |   |
|                                | M4LV-64/32-14JI      |                 |   |
|                                | M4LV-64/32-18JI      |                 |   |
|                                | M4LV-64/32-7VC       |                 |   |
|                                | M4LV-64/32-10VC      |                 |   |
|                                | M4LV-64/32-12VC      |                 |   |
|                                | M4LV-64/32-15VC      |                 |   |
|                                | M4LV-64/32-10VI      |                 |   |
|                                | M4LV-64/32-12VI      |                 |   |
|                                | M4LV-64/32-14VI      |                 |   |
|                                | M4LV-64/32-18VI      |                 |   |
|                                | M4LV-64/32-7VC48     |                 |   |
|                                | M4LV-64/32-10VC48    |                 |   |
|                                | M4LV-64/32-12VC48    |                 |   |
|                                | M4LV-64/32-15VC48    |                 |   |
| M4LV-64/32-10VI48              |                      |                 |   |
| M4LV-64/32-12VI48              |                      |                 |   |
| M4LV-64/32-14VI48              |                      |                 |   |
| M4LV-64/32-18VI48              |                      |                 |   |



| Product Line        | Ordering Part Number | Product Status  | Reference PCN   |
|---------------------|----------------------|-----------------|---|
| <b>M4LV-96/48</b>   | M4LV-96/48-7VC       | Convert to M4A3 | Contact <a href="mailto:pcn@latticesemi.com">pcn@latticesemi.com</a> for more info. |
|                     | M4LV-96/48-10VC      |                 |   |
|                     | M4LV-96/48-12VC      |                 |   |
|                     | M4LV-96/48-15VC      |                 |   |
|                     | M4LV-96/48-10VI      |                 |   |
|                     | M4LV-96/48-12VI      |                 |   |
|                     | M4LV-96/48-14VI      |                 |   |
|                     | M4LV-96/48-18VI      |                 |   |
| <b>M4LV-128/64</b>  | M4LV-128/64-7YC      | Convert to M4A3 | Contact <a href="mailto:pcn@latticesemi.com">pcn@latticesemi.com</a> for more info. |
|                     | M4LV-128/64-10YC     |                 |   |
|                     | M4LV-128/64-12YC     |                 |   |
|                     | M4LV-128/64-15YC     |                 |   |
|                     | M4LV-128/64-10YI     |                 |   |
|                     | M4LV-128/64-12YI     |                 |   |
|                     | M4LV-128/64-14YI     |                 |   |
|                     | M4LV-128/64-18YI     |                 |   |
|                     | M4LV-128/64-7VC      | Convert to M4A3 | Contact <a href="mailto:pcn@latticesemi.com">pcn@latticesemi.com</a> for more info. |
|                     | M4LV-128/64-10VC     |                 |   |
|                     | M4LV-128/64-12VC     |                 |   |
|                     | M4LV-128/64-15VC     |                 |   |
|                     | M4LV-128/64-10VI     |                 |   |
|                     | M4LV-128/64-12VI     |                 |   |
|                     | M4LV-128/64-14VI     |                 |   |
|                     | M4LV-128/64-18VI     |                 |   |
| <b>M4LV-128N/64</b> | M4LV-128N/64-7JC     | Discontinued    | <a href="#">PCN#09-10</a>   |
|                     | M4LV-128N/64-10JC    |                 |   |
|                     | M4LV-128N/64-12JC    |                 |   |
|                     | M4LV-128N/64-15JC    |                 |   |
|                     | M4LV-128N/64-10JI    |                 |   |
|                     | M4LV-128N/64-12JI    |                 |   |
|                     | M4LV-128N/64-14JI    |                 |   |
|                     | M4LV-128N/64-18JI    |                 |   |
| <b>M4LV-192/96</b>  | M4LV-192/96-7VC      | Convert to M4A3 | Contact <a href="mailto:pcn@latticesemi.com">pcn@latticesemi.com</a> for more info. |
|                     | M4LV-192/96-10VC     |                 |   |
|                     | M4LV-192/96-12VC     |                 |   |
|                     | M4LV-192/96-15VC     |                 |   |
|                     | M4LV-192/96-10VI     |                 |   |
|                     | M4LV-192/96-12VI     |                 |   |
|                     | M4LV-192/96-14VI     |                 |   |
|                     | M4LV-192/96-18VI     |                 |   |



| Product Line      | Ordering Part Number | Product Status  | Reference PCN   |
|-------------------|----------------------|-----------------|---|
| M4LV-256/128      | M4LV-256/128-7YC     | Convert to M4A3 | Contact<br><a href="mailto:pcn@latticesemi.com">pcn@latticesemi.com</a><br>for more info. |
|                   | M4LV-256/128-10YC    |                 |   |
|                   | M4LV-256/128-12YC    |                 |   |
|                   | M4LV-256/128-15YC    |                 |   |
|                   | M4LV-256/128-10YI    |                 |   |
|                   | M4LV-256/128-12YI    |                 |   |
|                   | M4LV-256/128-14YI    |                 |   |
|                   | M4LV-256/128-18YI    |                 |   |
|                   | M4LV-256/128-7AC     |                 |   |
|                   | M4LV-256/128-10AC    |                 |   |
|                   | M4LV-256/128-12AC    |                 |   |
|                   | M4LV-256/128-15AC    |                 |   |
|                   | M4LV-256/128-10AI    |                 |   |
|                   | M4LV-256/128-12AI    |                 |   |
|                   | M4LV-256/128-14AI    |                 |   |
| M4LV-256/128-18AI |                      |                 |   |

---

## FEATURES

- ◆ **High-performance, E<sup>2</sup>CMOS 3.3-V & 5-V CPLD families**
- ◆ **Flexible architecture for rapid logic designs**
  - Excellent First-Time-Fit<sup>™</sup> and refit feature
  - SpeedLocking<sup>™</sup> performance for guaranteed fixed timing
  - Central, input and output switch matrices for 100% routability and 100% pin-out retention
- ◆ **High speed**
  - 7.5ns t<sub>PD</sub> Commercial and 10ns t<sub>PD</sub> Industrial
  - 111.1MHz f<sub>CNT</sub>
- ◆ **32 to 256 macrocells; 32 to 384 registers**
- ◆ **44 to 256 pins in PLCC, PQFP, TQFP and BGA packages**
- ◆ **Flexible architecture for a wide range of design styles**
  - D/T registers and latches
  - Synchronous or asynchronous mode
  - Dedicated input registers
  - Programmable polarity
  - Reset/ preset swapping
- ◆ **Advanced capabilities for easy system integration**
  - 3.3-V & 5-V JEDEC-compliant operations
  - JTAG (IEEE 1149.1) compliant for boundary scan testing
  - 3.3-V & 5-V JTAG in-system programming
  - PCI compliant (-7/-10/-12 speed grades)
  - Safe for mixed supply voltage system designs
  - Bus-Friendly<sup>™</sup> inputs and I/Os
  - Programmable security bit
  - Individual output slew rate control
- ◆ **Advanced E<sup>2</sup>CMOS process provides high-performance, cost-effective solutions**
- ◆ **Supported by ispDesignEXPERT<sup>™</sup> software for rapid logic development**
  - Supports HDL design methodologies with results optimized for MACH 4
  - Flexibility to adapt to user requirements
  - Software partnerships that ensure customer success
- ◆ **Lattice and third-party hardware programming support**
  - LatticePRO<sup>™</sup> software for in-system programmability support on PCs and automated test equipment
  - Programming support on all major programmers including Data I/O, BP Microsystems, Advin, and System General

**Table 1. MACH 4 Device Features<sup>1, 2</sup>**

| Feature                | M4-32/32<br>M4LV-32/32 | M4-64/32<br>M4LV-64/32 | M4-96/48<br>M4LV-96/48 | M4-128/64<br>M4LV-128/64 | M4-128N/64<br>M4LV-128N/64 | M4-192/96<br>M4LV-192/96 | M4-256/128<br>M4LV-256/128 |
|------------------------|------------------------|------------------------|------------------------|--------------------------|----------------------------|--------------------------|----------------------------|
| Macrocells             | 32                     | 64                     | 96                     | 128                      | 128                        | 192                      | 256                        |
| Maximum User I/O Pins  | 32                     | 32                     | 48                     | 64                       | 64                         | 96                       | 128                        |
| t <sub>PD</sub> (ns)   | 7.5                    | 7.5                    | 7.5                    | 7.5                      | 7.5                        | 7.5                      | 7.5                        |
| f <sub>CNT</sub> (MHz) | 111                    | 111                    | 111                    | 111                      | 111                        | 111                      | 111                        |
| t <sub>COS</sub> (ns)  | 5.5                    | 5.5                    | 5.5                    | 5.5                      | 5.5                        | 5.5                      | 5.5                        |
| t <sub>SS</sub> (ns)   | 5.5                    | 5.5                    | 5.5                    | 5.5                      | 5.5                        | 5.5                      | 5.5                        |
| Static Power (mA)      | 25                     | 25                     | 50                     | 70                       | 70                         | 85                       | 100                        |
| JTAG Compliant         | Yes                    | Yes                    | Yes                    | Yes                      | No                         | Yes                      | Yes                        |
| PCI Compliant          | Yes                    | Yes                    | Yes                    | Yes                      | Yes                        | Yes                      | Yes                        |

**Notes:**

1. For information on the M4-96/96 device, please refer to the M4-96/96 data sheet at [www.latticesemi.com](http://www.latticesemi.com).
2. "M4-xxx" is for 5-V devices. "M4LV-xxx" is for 3.3-V devices.



## GENERAL DESCRIPTION

The MACH<sup>®</sup> 4 family from Lattice offers an exceptionally flexible architecture and delivers a superior Complex Programmable Logic Device (CPLD) solution of easy-to-use silicon products and software tools. The overall benefits for users are a guaranteed and predictable CPLD solution, faster time-to-market, greater flexibility and lower cost. The MACH 4 devices offer densities ranging from 32 to 256 macrocells with 100% utilization and 100% pin-out retention. The MACH 4 family offer 5-V (M4-xxx) and 3.3-V (M4LV-xxx) operation.

MACH 4 products are 5-V or 3.3-V in-system programmable through the JTAG (IEEE Std. 1149.1) interface. JTAG boundary scan testing also allows product testability on automated test equipment for device connectivity.

All MACH 4 family members deliver First-Time-Fit and easy system integration with pin-out retention after any design change and refit. For both 3.3-V and 5-V operation, MACH 4 products can deliver guaranteed fixed timing as fast as 7.5 ns  $t_{PD}$  and 111 MHz  $f_{CNT}$  through the SpeedLocking feature when using up to 20 product terms per output (Table 2).

**Table 2. MACH 4 Speed Grades**

| Device       | Speed Grade <sup>1</sup> |      |      |     |     |     |
|--------------|--------------------------|------|------|-----|-----|-----|
|              | -7                       | -10  | -12  | -14 | -15 | -18 |
| M4-32/32     | C                        | C, I | C, I | I   | C   | I   |
| M4LV-32/32   |                          |      |      |     |     |     |
| M4-64/32     | C                        | C, I | C, I | I   | C   | I   |
| M4LV-64/32   |                          |      |      |     |     |     |
| M4-96/48     | C                        | C, I | C, I | I   | C   | I   |
| M4LV-96/48   |                          |      |      |     |     |     |
| M4-128/64    | C                        | C, I | C, I | I   | C   | I   |
| M4LV-128/64  |                          |      |      |     |     |     |
| M4-128N/64   | C                        | C, I | C, I | I   | C   | I   |
| M4LV-128N/64 |                          |      |      |     |     |     |
| M4-192/96    | C                        | C, I | C, I | I   | C   | I   |
| M4LV-192/96  |                          |      |      |     |     |     |
| M4-256/128   | C                        | C, I | C, I | I   | C   | I   |
| M4LV-256/128 |                          |      |      |     |     |     |

**Note:**

1. C = Commercial, I = Industrial

The MACH 4 family offers numerous density-I/O combinations in Thin Quad Flat Pack (TQFP), Plastic Quad Flat Pack (PQFP), Plastic Leaded Chip Carrier (PLCC), and Ball Grid Array (BGA) packages ranging from 44 to 256 pins (Table 3). It also offers I/O safety features for mixed-voltage designs so that the 3.3-V devices can accept 5-V inputs, and 5-V devices do not overdrive 3.3-V inputs. Additional features include Bus-Friendly inputs and I/Os, a programmable power-down mode for extra power savings and individual output slew rate control for the highest speed transition or for the lowest noise transition.

**Table 3. MACH 4 Package and I/O Options (Number of I/Os and dedicated inputs in Table)**

| Package      | M4-32/32<br>M4LV-32/32 | M4-64/32<br>M4LV-64/32 | M4-96/48<br>M4LV-96/48 | M4-128/64<br>M4LV-128/64 | M4-128N/64<br>M4LV-128N/64 | M4-192/96<br>M4LV-192/96 | M4LV-256/128 |
|--------------|------------------------|------------------------|------------------------|--------------------------|----------------------------|--------------------------|--------------|
| 44-pin PLCC  | 32+2                   | 32+2                   |                        |                          |                            |                          |              |
| 44-pin TQFP  | 32+2                   | 32+2                   |                        |                          |                            |                          |              |
| 48-pin TQFP  | 32+2                   | 32+2                   |                        |                          |                            |                          |              |
| 84-pin PLCC  |                        |                        |                        |                          | 64+6                       |                          |              |
| 100-pin TQFP |                        |                        | 48+8                   | 64+6                     |                            |                          |              |
| 100-pin PQFP |                        |                        |                        | 64+6                     |                            |                          |              |
| 144-pin TQFP |                        |                        |                        |                          |                            | 96+16                    |              |
| 208-pin PQFP |                        |                        |                        |                          |                            |                          | 128+14       |
| 256-ball BGA |                        |                        |                        |                          |                            |                          | 128+14       |

SELECT DEVICES CONVERTED OR DISCONTINUED

## FUNCTIONAL DESCRIPTION

The fundamental architecture of MACH 4 devices (Figure 1) consists of multiple, optimized PAL<sup>®</sup> blocks interconnected by a central switch matrix. The central switch matrix allows communication between PAL blocks and routes inputs to the PAL blocks. Together, the PAL blocks and central switch matrix allow the logic designer to create large designs in a single device instead of having to use multiple devices.

The key to being able to make effective use of these devices lies in the interconnect schemes. In MACH 4 architecture, the macrocells are flexibly coupled to the product terms through the logic allocator, and the I/O pins are flexibly coupled to the macrocells due to the output switch matrix. In addition, more input routing options are provided by the input switch matrix. These resources provide the flexibility needed to fit designs efficiently.

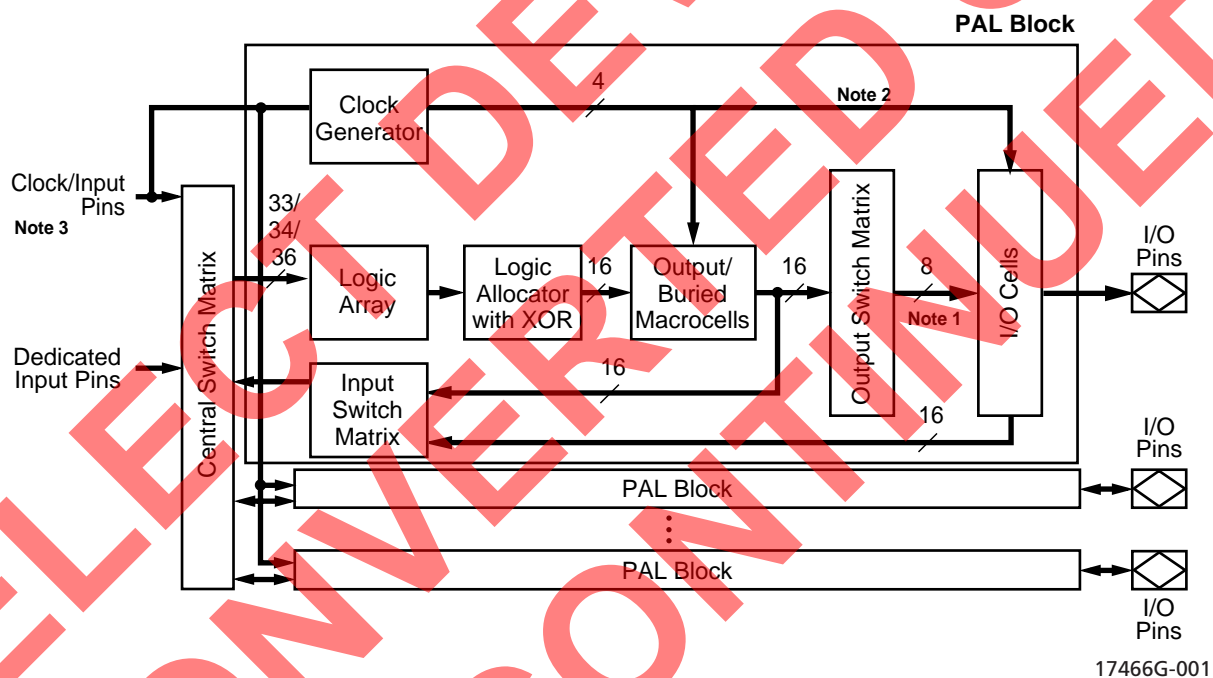

Figure 1. MACH 4 Block Diagram and PAL Block Structure

**Notes:**

1. 16 for MACH 4 devices with 1:1 macrocell-I/O cell ratio (see next page).
2. Block clocks do not go to I/O cells in M4(LV)-32/32.
3. M4(LV)-192/96 and M4(LV)-256/128 have dedicated clock pins which cannot be used as inputs and do not connect to the central switch matrix.

**Table 4. Architectural Summary of MACH 4 devices**

|                          | MACH 4 Devices |  |
|--------------------------|----------------|--|
|                          |                | M4-64/32, M4LV-64/32<br>M4-96/48, M4LV-96/48<br>M4-128/64, M4LV-128/64<br>M4-128N/64, M4LV-128N/64<br>M4-192/96, M4LV-192/96<br>M4-256/128, M4LV-256/128 |
| Macrocell-I/O Cell Ratio | 2:1            | 1:1  |
| Input Switch Matrix      | Yes            | Yes  |
| Input Registers          | Yes            | No   |
| Central Switch Matrix    | Yes            | Yes  |
| Output Switch Matrix     | Yes            | Yes  |

The Macrocell-I/O cell ratio is defined as the number of macrocells versus the number of I/O cells internally in a PAL block (Table 4).

The central switch matrix takes all dedicated inputs and signals from the input switch matrices and routes them as needed to the PAL blocks. Feedback signals that return to the same PAL block still must go through the central switch matrix. This mechanism ensures that PAL blocks in MACH 4 devices communicate with each other with consistent, predictable delays.

The central switch matrix makes a MACH 4 device more advanced than simply several PAL devices on a single chip. It allows the designer to think of the device not as a collection of blocks, but as a single programmable device; the software partitions the design into PAL blocks through the central switch matrix so that the designer does not have to be concerned with the internal architecture of the device.

Each PAL block consists of:

- ◆ Product-term array
- ◆ Logic allocator
- ◆ Macrocells
- ◆ Output switch matrix
- ◆ I/O cells
- ◆ Input switch matrix
- ◆ Clock generator

## Product-Term Array

The product-term array consists of a number of product terms that form the basis of the logic being implemented. The inputs to the AND gates come from the central switch matrix (Table 5), and are provided in both true and complement forms for efficient logic implementation.

**Table 5. PAL Block Inputs**

| Device                      | Number of Inputs to PAL Block |
|-----------------------------|-------------------------------|
| M4-32/32 and M4IV-32/32     | 33                            |
| M4-64/32 and M4IV-64/32     | 33                            |
| M4-96/48 and M4IV-96/48     | 33                            |
| M4-128/64 and M4IV-128/64   | 33                            |
| M4-128N/64 and M4IV-128N/64 | 33                            |
| M4-192/96 and M4IV-192/96   | 34                            |
| M4-256/128 and M4IV-256/128 | 34                            |

## Logic Allocator

Within the logic allocator, product terms are allocated to macrocells in “product term clusters.” The availability and distribution of product term clusters are automatically considered by the software as it fits functions within a PAL block. The size of a product term cluster has been optimized to provide high utilization of product terms, making complex functions using many product terms possible. Yet when few product terms are used, there will be a minimal number of unused—or wasted—product terms left over. The product term clusters available to each macrocell within a PAL block are shown in Tables 6 and 7.

Each product term cluster is associated with a macrocell. The size of a cluster depends on the configuration of the associated macrocell. When the macrocell is used in synchronous mode (Figure 2a), the basic cluster has 4 product terms. When the associated macrocell is used in asynchronous mode (Figure 2b), the cluster has 2 product terms. Note that if the product term cluster is routed to a different macrocell, the allocator configuration is not determined by the mode of the macrocell actually being driven. The configuration is always set by the mode of the macrocell that the cluster will drive if not routed away, regardless of the actual routing.

In addition, there is an extra product term that can either join the basic cluster to give an extended cluster, or drive the second input of an exclusive-OR gate in the signal path. If included with the basic cluster, this provides for up to 20 product terms on a synchronous function that uses four extended 5-product-term clusters. A similar asynchronous function can have up to 18 product terms.

When the extra product term is used to extend the cluster, the value of the second XOR input can be programmed as a 0 or a 1, giving polarity control. The possible configurations of the logic allocator are shown in Figures 3 and 4.

**Table 6. Logic Allocator for All MACH 4 Devices (except M4(LV)-32/32)**

| Output Macrocell | Available Clusters  | Output Macrocell | Available Clusters  |
|------------------|---|------------------|---|
| M <sub>0</sub>   | C <sub>0</sub> , C <sub>1</sub> , C <sub>2</sub>                  | M <sub>8</sub>   | C <sub>7</sub> , C <sub>8</sub> , C <sub>9</sub> , C <sub>10</sub>    |
| M <sub>1</sub>   | C <sub>0</sub> , C <sub>1</sub> , C <sub>2</sub> , C <sub>3</sub> | M <sub>9</sub>   | C <sub>8</sub> , C <sub>9</sub> , C <sub>10</sub> , C <sub>11</sub>   |
| M <sub>2</sub>   | C <sub>1</sub> , C <sub>2</sub> , C <sub>3</sub> , C <sub>4</sub> | M <sub>10</sub>  | C <sub>9</sub> , C <sub>10</sub> , C <sub>11</sub> , C <sub>12</sub>  |
| M <sub>3</sub>   | C <sub>2</sub> , C <sub>3</sub> , C <sub>4</sub> , C <sub>5</sub> | M <sub>11</sub>  | C <sub>10</sub> , C <sub>11</sub> , C <sub>12</sub> , C <sub>13</sub> |
| M <sub>4</sub>   | C <sub>3</sub> , C <sub>4</sub> , C <sub>5</sub> , C <sub>6</sub> | M <sub>12</sub>  | C <sub>11</sub> , C <sub>12</sub> , C <sub>13</sub> , C <sub>14</sub> |
| M <sub>5</sub>   | C <sub>4</sub> , C <sub>5</sub> , C <sub>6</sub> , C <sub>7</sub> | M <sub>13</sub>  | C <sub>12</sub> , C <sub>13</sub> , C <sub>14</sub> , C <sub>15</sub> |
| M <sub>6</sub>   | C <sub>5</sub> , C <sub>6</sub> , C <sub>7</sub> , C <sub>8</sub> | M <sub>14</sub>  | C <sub>13</sub> , C <sub>14</sub> , C <sub>15</sub>                   |
| M <sub>7</sub>   | C <sub>6</sub> , C <sub>7</sub> , C <sub>8</sub> , C <sub>9</sub> | M <sub>15</sub>  | C <sub>14</sub> , C <sub>15</sub>                                     |

**Table 7. Logic Allocator for M4(LV)-32/32**

| Output Macrocell | Available Clusters  | Output Macrocell | Available Clusters  |
|------------------|---|------------------|---|
| M <sub>0</sub>   | C <sub>0</sub> , C <sub>1</sub> , C <sub>2</sub>                  | M <sub>8</sub>   | C <sub>8</sub> , C <sub>9</sub> , C <sub>10</sub>                     |
| M <sub>1</sub>   | C <sub>0</sub> , C <sub>1</sub> , C <sub>2</sub> , C <sub>3</sub> | M <sub>9</sub>   | C <sub>8</sub> , C <sub>9</sub> , C <sub>10</sub> , C <sub>11</sub>   |
| M <sub>2</sub>   | C <sub>1</sub> , C <sub>2</sub> , C <sub>3</sub> , C <sub>4</sub> | M <sub>10</sub>  | C <sub>9</sub> , C <sub>10</sub> , C <sub>11</sub> , C <sub>12</sub>  |
| M <sub>3</sub>   | C <sub>2</sub> , C <sub>3</sub> , C <sub>4</sub> , C <sub>5</sub> | M <sub>11</sub>  | C <sub>10</sub> , C <sub>11</sub> , C <sub>12</sub> , C <sub>13</sub> |
| M <sub>4</sub>   | C <sub>3</sub> , C <sub>4</sub> , C <sub>5</sub> , C <sub>6</sub> | M <sub>12</sub>  | C <sub>11</sub> , C <sub>12</sub> , C <sub>13</sub> , C <sub>14</sub> |
| M <sub>5</sub>   | C <sub>4</sub> , C <sub>5</sub> , C <sub>6</sub> , C <sub>7</sub> | M <sub>13</sub>  | C <sub>12</sub> , C <sub>13</sub> , C <sub>14</sub> , C <sub>15</sub> |
| M <sub>6</sub>   | C <sub>5</sub> , C <sub>6</sub> , C <sub>7</sub>                  | M <sub>14</sub>  | C <sub>13</sub> , C <sub>14</sub> , C <sub>15</sub>                   |
| M <sub>7</sub>   | C <sub>6</sub> , C <sub>7</sub>                                   | M <sub>15</sub>  | C <sub>14</sub> , C <sub>15</sub>                                     |



**a. Synchronous Mode**

17466G-005



**b. Asynchronous Mode**

17466G-006

**Figure 2. Logic Allocator: Configuration of Cluster "n" Set by Mode of Macrocell "n"**

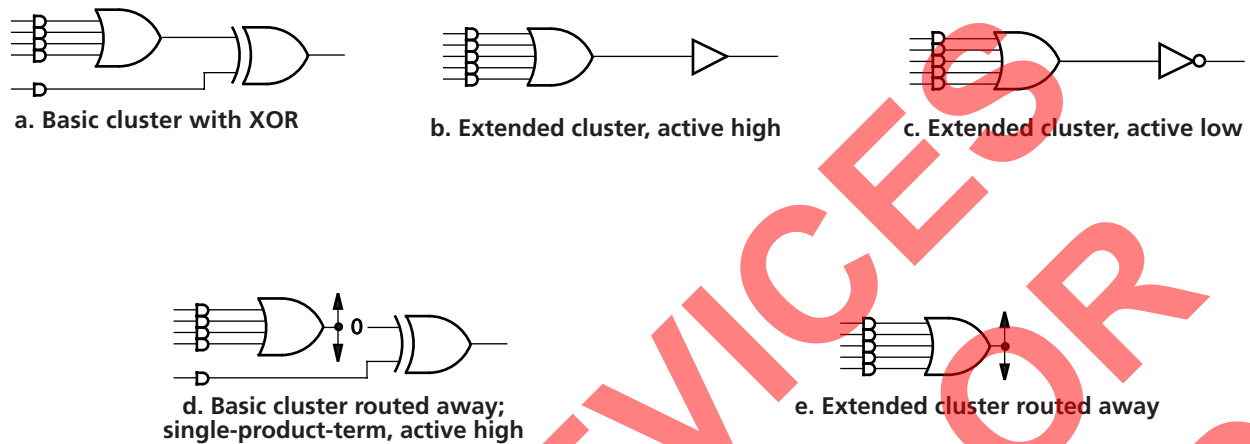

Figure 3. Logic Allocator Configurations: Synchronous Mode

17466G-007

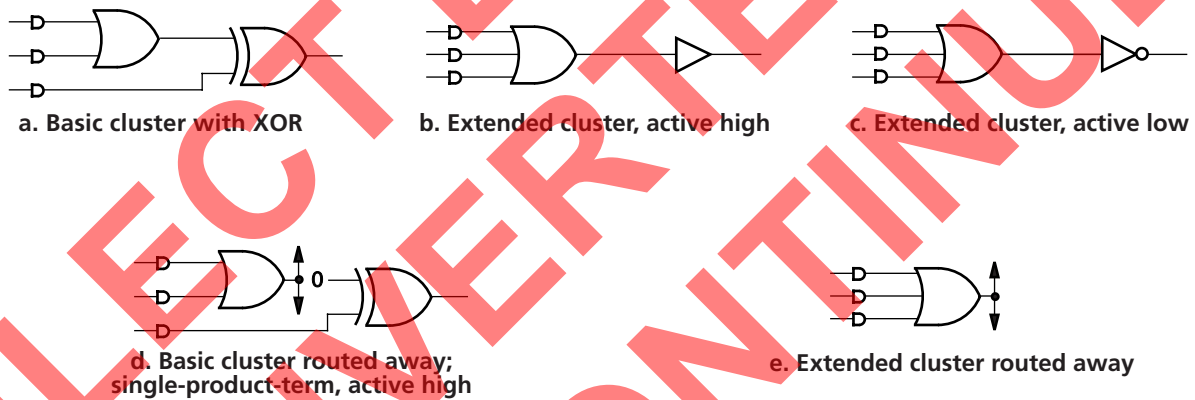

Figure 4. Logic Allocator Configurations: Asynchronous Mode

17466G-008

Note that the configuration of the logic allocator has absolutely no impact on the speed of the signal. All configurations have the same delay. This means that designers do not have to decide between optimizing resources or speed; both can be optimized.

If not used in the cluster, the extra product term can act in conjunction with the basic cluster to provide XOR logic for such functions as data comparison, or it can work with the D-,T-type flip-flop to provide for J-K, and S-R register operation. In addition, if the basic cluster is routed to another macrocell, the extra product term is still available for logic. In this case, the first XOR input will be a logic 0. This circuit has the flexibility to route product terms elsewhere without giving up the use of the macrocell.

Product term clusters do not “wrap” around a PAL block. This means that the macrocells at the ends of the block have fewer product terms available.

## Macrocell

The macrocell consists of a storage element, routing resources, a clock multiplexer, and initialization control. The macrocell has two fundamental modes: synchronous and asynchronous (Figure 5). The mode chosen only affects clocking and initialization in the macrocell.

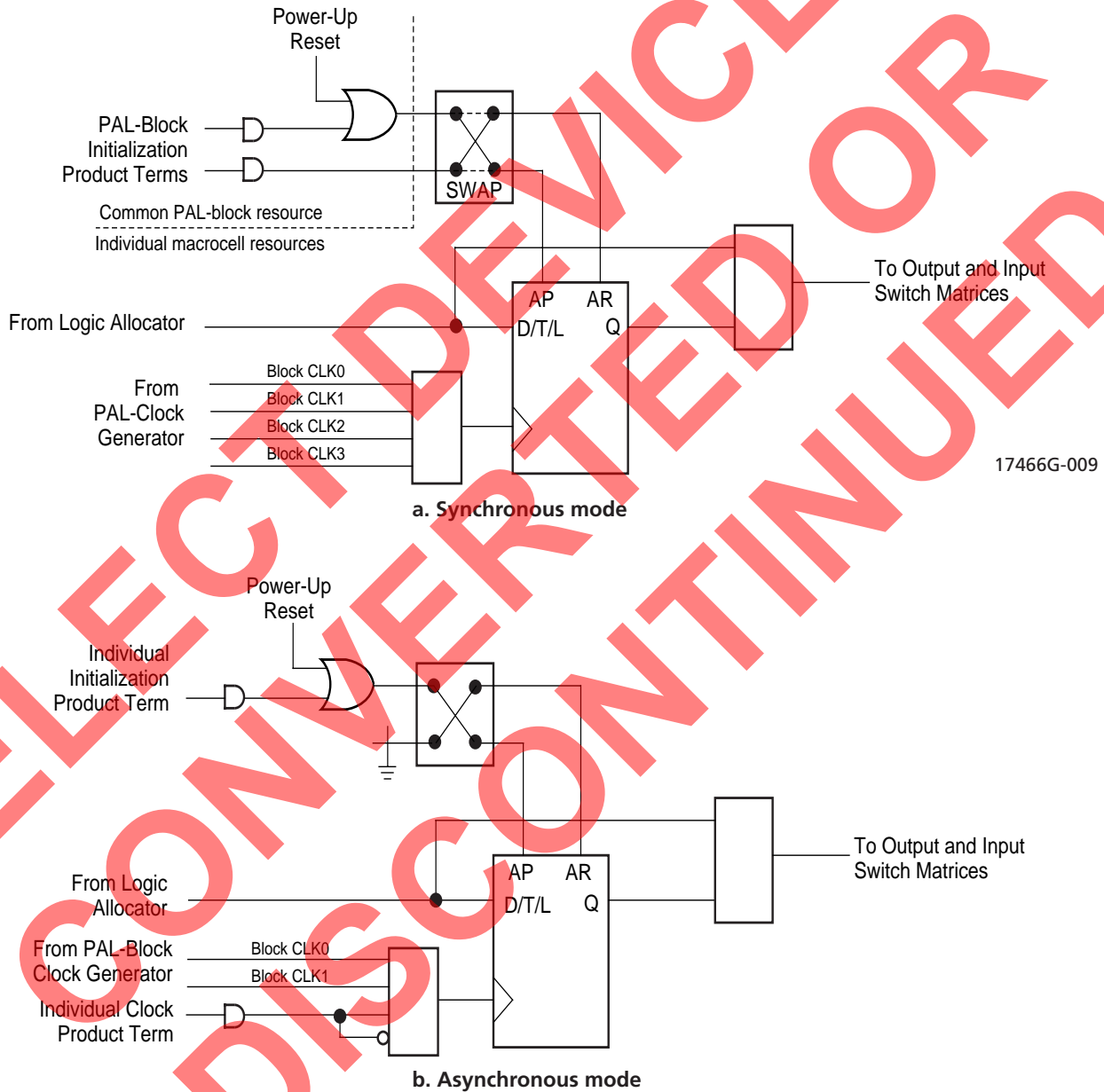

Figure 5. Macrocell

In either mode, a combinatorial path can be used. For combinatorial logic, the synchronous mode will generally be used, since it provides more product terms in the allocator.



The flip-flop can be configured as a D-type or T-type latch. J-K or S-R registers can be synthesized. The primary flip-flop configurations are shown in Figure 6, although others are possible. Flip-flop functionality is defined in Table 8. Note that a J-K latch is inadvisable as it will cause oscillation if both J and K inputs are HIGH.

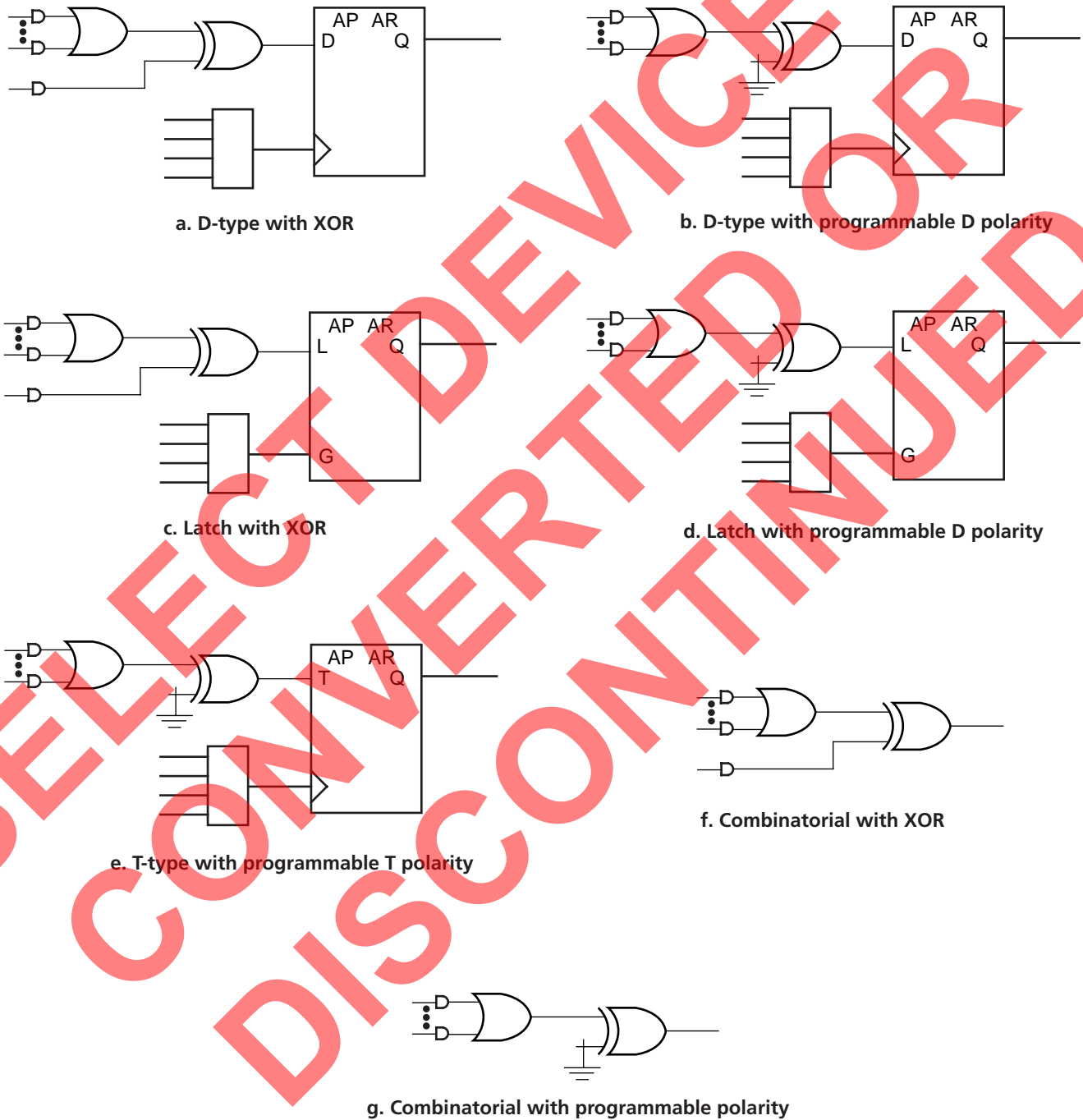

Figure 6. Primary Macrocell Configurations

17466G-011

**Table 8. Register/Latch Operation**

| Configuration   | Input(s) | CLK/LE <sup>1</sup> | Q+             |
|-----------------|----------|---------------------|----------------|
| D-type Register | D=X      | 0, 1, ↓ (↑)         | Q              |
|                 | D=0      | ↑ (↓)               | 0              |
|                 | D=1      | ↑ (↓)               | 1              |
| T-type Register | T=X      | 0, 1, ↓ (↑)         | Q              |
|                 | T=0      | ↑ (↓)               | $\overline{Q}$ |
|                 | T=1      | ↑ (↓)               | Q              |
| D-type Latch    | D=X      | 1 (0)               | Q              |
|                 | D=0      | 0 (1)               | 0              |
|                 | D=1      | 0 (1)               | 1              |

**Note:**

1. Polarity of CLK/LE can be programmed

Although the macrocell shows only one input to the register, the XOR gate in the logic allocator allows the D-, T-type register to emulate J-K, and S-R behavior. In this case, the available product terms are divided between J and K (or S and R). When configured as J-K, S-R, or T-type, the extra product term must be used on the XOR gate input for flip-flop emulation. In any register type, the polarity of the inputs can be programmed.

The clock input to the flip-flop can select any of the four PAL block clocks in synchronous mode, with the additional choice of either polarity of an individual product term clock in the asynchronous mode.

The initialization circuit depends on the mode. In synchronous mode (Figure 7), asynchronous reset and preset are provided, each driven by a product term common to the entire PAL block.



17466G-012

17466G-013

**Figure 7. Synchronous Mode Initialization Configurations**

A reset/preset swapping feature in each macrocell allows for reset and preset to be exchanged, providing flexibility. In asynchronous mode (Figure 8), a single individual product term is provided for initialization. It can be selected to control reset or preset.

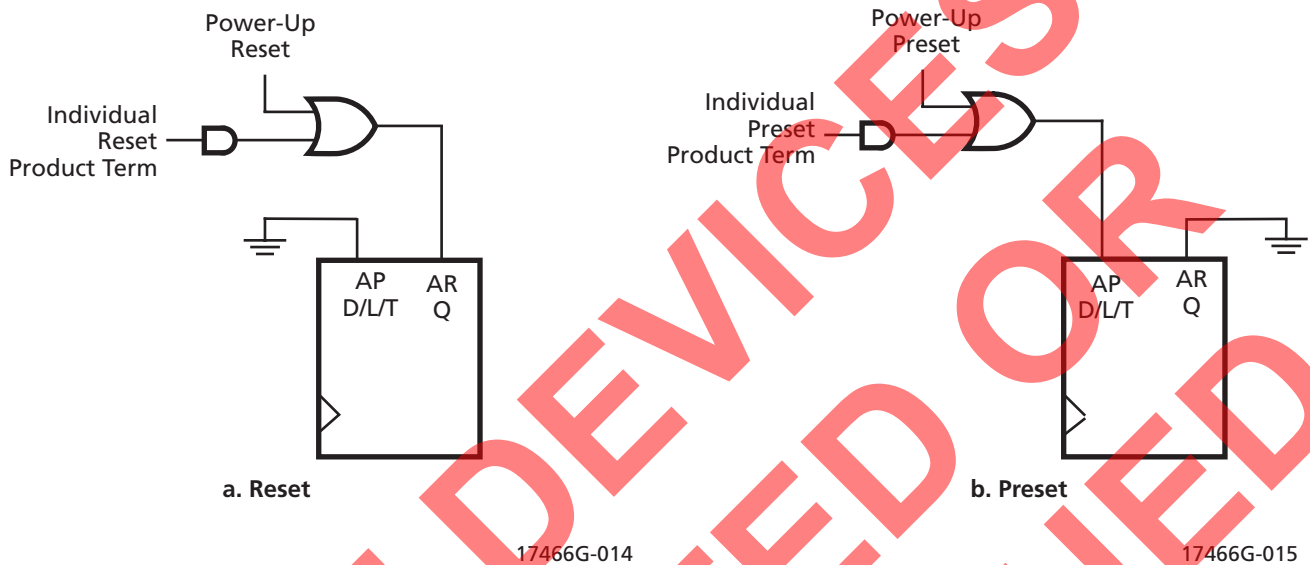

**Figure 8. Asynchronous Mode Initialization Configurations**

Note that the reset/preset swapping selection feature effects power-up reset as well. The initialization functionality of the flip-flops is illustrated in Table 9. The macrocell sends its data to the output switch matrix and the input switch matrix. The output switch matrix can route this data to an output if so desired. The input switch matrix can send the signal back to the central switch matrix as feedback.

**Table 9. Asynchronous Reset/Preset Operation**

| AR | AP | CLK/LE <sup>1</sup> | Q+          |
|----|----|---------------------|-------------|
| 0  | 0  | X                   | See Table 8 |
| 0  | 1  | X                   | 1           |
| 1  | 0  | X                   | 0           |
| 1  | 1  | X                   | 0           |

**Note:**

1. Transparent latch is unaffected by AR, AP

## Output Switch Matrix

The output switch matrix allows macrocells to be connected to any of several I/O cells within a PAL block. This provides high flexibility in determining pinout and allows design changes to occur without effecting pinout.

In MACH 4 devices with 2:1 Macrocell-I/O cell ratio, each PAL block has twice as many macrocells as I/O cells. The MACH 4 output switch matrix allows for half of the macrocells to drive I/O cells within a PAL block, in combinations according to Figure 9. Each I/O cell can choose from eight macrocells; each macrocell has a choice of four I/O cells. The MACH 4 devices with 1:1 Macrocell-I/O cell ratio allow each macrocell to drive one of eight I/O cells (Figure 9).



Figure 9. MACH 4 Output Switch Matrix

**Table 10. Output Switch Matrix Combinations for MACH 4 Devices with 2:1 Macrocell-I/O Cell Ratio**

| Macrocell | Routable to I/O Cells  |
|-----------|------------------------|
| M0, M1    | I/O0, I/O5, I/O6, I/O7 |
| M2, M3    | I/O0, I/O1, I/O6, I/O7 |
| M4, M5    | I/O0, I/O1, I/O2, I/O7 |
| M6, M7    | I/O0, I/O1, I/O2, I/O3 |
| M8, M9    | I/O1, I/O2, I/O3, I/O4 |
| M10, M11  | I/O2, I/O3, I/O4, I/O5 |
| M12, M13  | I/O3, I/O4, I/O5, I/O6 |
| M14, M15  | I/O4, I/O5, I/O6, I/O7 |

| I/O Cell | Available Macrocells                 |
|----------|--------------------------------------|
| I/O0     | M0, M1, M2, M3, M4, M5, M6, M7       |
| I/O1     | M2, M3, M4, M5, M6, M7, M8, M9       |
| I/O2     | M4, M5, M6, M7, M8, M9, M10, M11     |
| I/O3     | M6, M7, M8, M9, M10, M11, M12, M13   |
| I/O4     | M8, M9, M10, M11, M12, M13, M14, M15 |
| I/O5     | M0, M1, M10, M11, M12, M13, M14, M15 |
| I/O6     | M0, M1, M2, M3, M12, M13, M14, M15   |
| I/O7     | M0, M1, M2, M3, M4, M5, M14, M15     |

**Table 11. Output Switch Matrix Combinations for M4(LV)-32/32**

| Macrocell                            | Routable to I/O Cells                                |
|--------------------------------------|--|
| M0, M1, M2, M3, M4, M5, M6, M7       | I/O0, I/O1, I/O2, I/O3, I/O4, I/O5, I/O6, I/O7       |
| M8, M9, M10, M11, M12, M13, M14, M15 | I/O8, I/O9, I/O10, I/O11, I/O12, I/O13, I/O14, I/O15 |

| I/O Cell   | Available Macrocells                 |
|--|--------------------------------------|
| I/O0, I/O1, I/O2, I/O3, I/O4, I/O5, I/O6, I/O7       | M0, M1, M2, M3, M4, M5, M6, M7       |
| I/O8, I/O9, I/O10, I/O11, I/O12, I/O13, I/O14, I/O15 | M8, M9, M10, M11, M12, M13, M14, M15 |

## I/O Cell

The I/O cell (Figures 10 and 11) simply consists of a programmable output enable, a feedback path, and flip-flop (except MACH 4 devices with 1:1 macrocell-I/O cell ratio.) An individual output enable product term is provided for each I/O cell. The feedback signal drives the input switch matrix.



17466G-017

**Figure 10. I/O Cell for MACH 4 Devices with 2:1 Macrocell-I/O Cell Ratio**



17466G-018

**Figure 11. I/O Cell for MACH 4 Devices with 1:1 Macrocell-I/O Cell Ratio**

The I/O cell (Figure 10) contains a flip-flop, which provides the capability for storing the input in a D-type register or latch. The clock can be any of the PAL block clocks. Both the direct and registered versions of the input are sent to the input switch matrix. This allows for such functions as “time-domain-multiplexed” data comparison, where the first data value is stored, and then the second data value is put on the I/O pin and compared with the previous stored value.

Note that the flip-flop used in the MACH 4 I/O cell is independent of the flip-flops in the macrocells. It powers up to a logic low.

### Zero-Hold-Time Input Register

The MACH 4 devices have a zero-hold-time (ZHT) fuse which controls the time delay associated with loading data into all I/O cell registers and latches. When programmed, the ZHT fuse increases the data path setup delays to input storage elements, matching equivalent delays in the clock path. When the fuse is erased, the setup time to the input storage element is minimized. This feature facilitates doing worst-case designs for which data is loaded from sources which have low (or zero) minimum output propagation delays from clock edges.

### Input Switch Matrix

The input switch matrix (Figures 12 and 13) optimizes routing of inputs to the central switch matrix. Without the input switch matrix, each input and feedback signal has only one way to enter the central switch matrix. The input switch matrix provides additional ways for these signals to enter the central switch matrix.

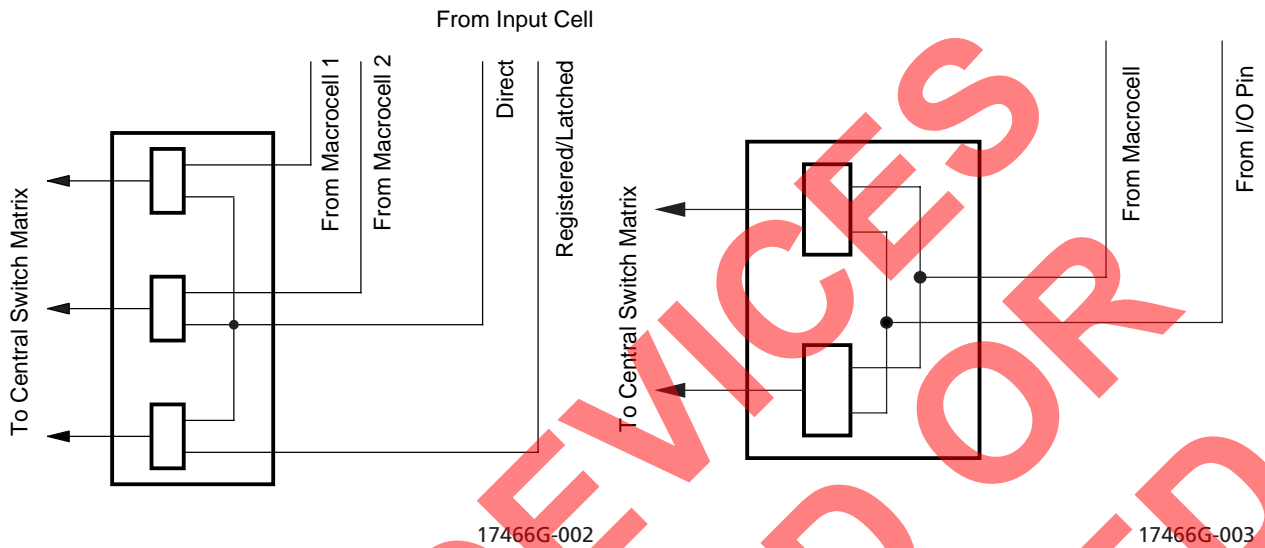

Figure 12. MACH 4 with 2:1 Macrocell-I/O Cell Ratio - Input Switch Matrix

Figure 13. MACH 4 with 1:1 Macrocell-I/O Cell Ratio - Input Switch Matrix

### PAL Block Clock Generation

Each MACH 4 device has four clock pins that can also be used as inputs. These pins drive a clock generator in each PAL block (Figure 14). The clock generator provides four clock signals that can be used anywhere in the PAL block. These four PAL block clock signals can consist of a large number of combinations of the true and complement edges of the global clock signals. Table 12 lists the possible combinations.

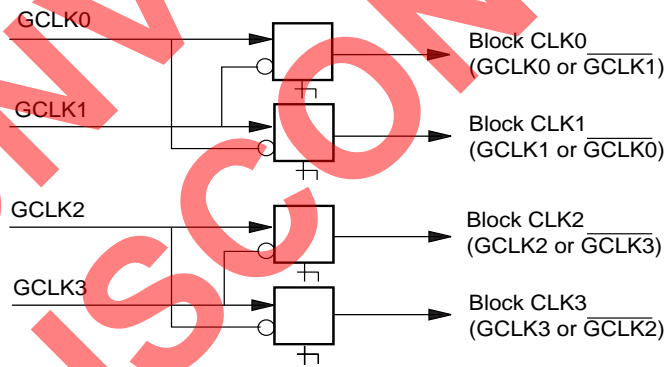

Figure 14. PAL Block Clock Generator <sup>1</sup>

17466G-004

**Note:**

1. M4(LV)-32/32 and M4(LV)-64/32 have only two clock pins, GCLK0 and GCLK1. GCLK2 is tied to GCLK0, and GCLK3 is tied to GCLK1.

**Table 12. PAL Block Clock Combinations<sup>1</sup>**

| Block CLK0                | Block CLK1                | Block CLK2  | Block CLK3  |
|---------------------------|---------------------------|---|---|
| GCLK0                     | GCLK1                     | X   | X   |
| $\overline{\text{GCLK1}}$ | GCLK1                     | X   | X   |
| GCLK0                     | $\overline{\text{GCLK0}}$ | X   | X   |
| $\overline{\text{GCLK1}}$ | $\overline{\text{GCLK0}}$ | X   | X   |
| X                         | X                         | GCLK2 ( $\overline{\text{GCLK0}}$ )                     | GCLK3 ( $\overline{\text{GCLK1}}$ )                     |
| X                         | X                         | $\overline{\text{GCLK3}}$ ( $\overline{\text{GCLK1}}$ ) | $\overline{\text{GCLK3}}$ ( $\overline{\text{GCLK1}}$ ) |
| X                         | X                         | $\overline{\text{GCLK2}}$ ( $\overline{\text{GCLK0}}$ ) | $\overline{\text{GCLK2}}$ ( $\overline{\text{GCLK0}}$ ) |
| X                         | X                         | $\overline{\text{GCLK3}}$ ( $\overline{\text{GCLK1}}$ ) | $\overline{\text{GCLK2}}$ ( $\overline{\text{GCLK0}}$ ) |

**Note:**

1. Values in parentheses are for the M4(LV)-32/32 and M4(LV)-64/32.

This feature provides high flexibility for partitioning state machines and dual-phase clocks. It also allows latches to be driven with either polarity of latch enable, and in a master-slave configuration.

SELECT DEVICES CONVERTED OR DISCONTINUED



## MACH 4 TIMING MODEL

The primary focus of the MACH 4 timing model is to accurately represent the timing in a MACH 4 device, and at the same time, be easy to understand. This model accurately describes all combinatorial and registered paths through the device, making a distinction between internal feedback and external feedback. A signal uses internal feedback when it is fed back into the switch matrix or block without having to go through the output buffer. The input register specifications are also reported as internal feedback. When a signal is fed back into the switch matrix after having gone through the output buffer, it is using external feedback.

The parameter,  $t_{BUF}$ , is defined as the time it takes to go from feedback through the output buffer to the I/O pad. If a signal goes to the internal feedback rather than to the I/O pad, the parameter designator is followed by an “i”. By adding  $t_{BUF}$  to this internal parameter, the external parameter is derived. For example,  $t_{PD} = t_{PDi} + t_{BUF}$ . A diagram representing the modularized MACH 4 timing model is shown in Figure 15. Refer to the Technical Note entitled *MACH 4 Timing and High Speed Design* for a more detailed discussion about the timing parameters.

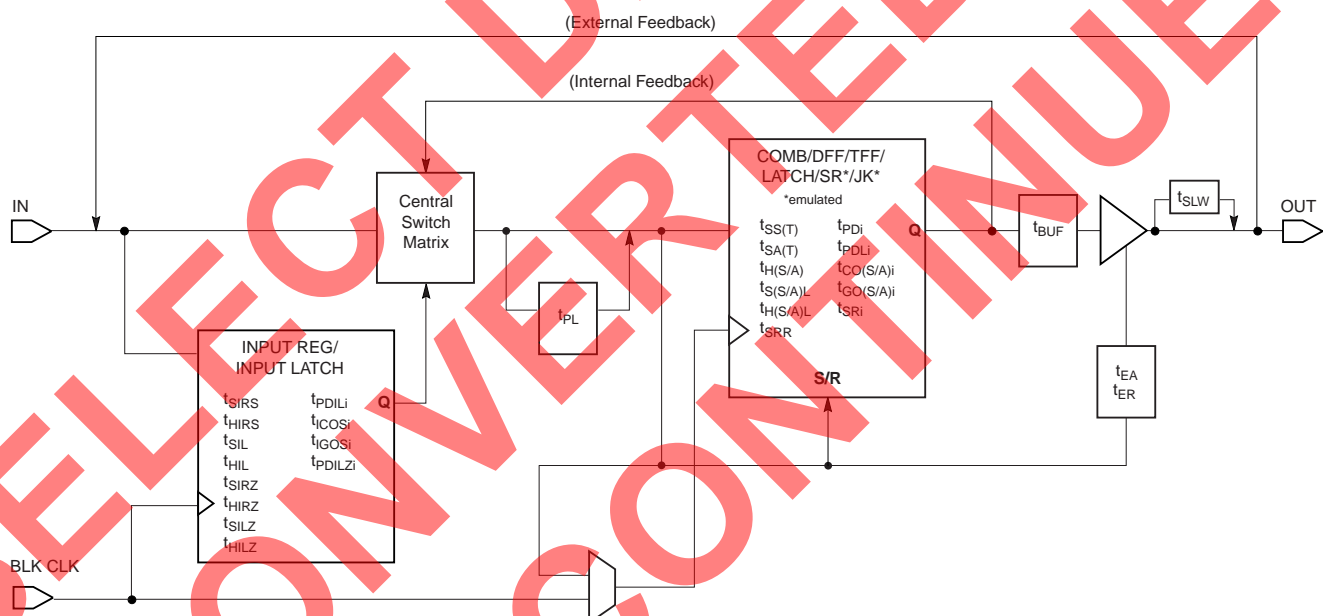

17466G-025

Figure 15. MACH 4 Timing Model

## SPEEDLOCKING FOR GUARANTEED FIXED TIMING

The MACH 4 architecture allows allocation of up to 20 product terms to an individual macrocell with the assistance of an XOR gate without incurring additional timing delays.

The design of the switch matrix and PAL blocks guarantee a fixed pin-to-pin delay that is independent of the logic required by the design. Other competitive CPLDs incur serious timing delays as product terms expand beyond their typical 4 or 5 product term limits. Speed and SpeedLocking combine to give designs easy access to the performance required in today’s designs.

## IEEE 1149.1-COMPLIANT BOUNDARY SCAN TESTABILITY

All MACH 4 devices, except the M4(LV)-128N/64, have boundary scan cells and are compliant to the IEEE 1149.1 standard. This allows functional testing of the circuit board on which the device is mounted through a serial scan path that can access all critical logic nodes. Internal registers are linked internally, allowing test data to be shifted in and loaded directly onto test nodes, or test node data to be captured and shifted out for verification. In addition, these devices can be linked into a board-level serial scan path for more complete board-level testing.

## IEEE 1149.1-COMPLIANT IN-SYSTEM PROGRAMMING

Programming devices in-system provides a number of significant benefits including: rapid prototyping, lower inventory levels, higher quality, and the ability to make in-field modifications. All MACH 4 devices provide In-System Programming (ISP) capability through their Boundary ScanTest Access Ports. This capability has been implemented in a manner that ensures that the port remains compliant to the IEEE 1149.1 standard. By using IEEE 1149.1 as the communication interface through which ISP is achieved, customers get the benefit of a standard, well-defined interface.

MACH 4 devices can be programmed across the commercial temperature and voltage range. The PC-based LatticePRO software facilitates in-system programming of MACH 4 devices. LatticePRO takes the JEDEC file output produced by the design implementation software, along with information about the JTAG chain, and creates a set of vectors that are used to drive the JTAG chain. LatticePRO software can use these vectors to drive a JTAG chain via the parallel port of a PC. Alternatively, LatticePRO software can output files in formats understood by common automated test equipment. This equipment can then be used to program MACH 4 devices during the testing of a circuit board.

## PCI COMPLIANT

MACH 4 devices in the -7/-10/-12 speed grades are compliant with the *PCI Local Bus Specification* version 2.1, published by the PCI Special Interest Group (SIG). The 5-V devices are fully PCI-compliant. The 3.3-V devices are mostly compliant but do not meet the PCI condition to clamp the inputs as they rise above  $V_{CC}$  because of their 5-V input tolerant feature.

## SAFE FOR MIXED SUPPLY VOLTAGE SYSTEM DESIGNS

Both the 3.3-V and 5-V  $V_{CC}$  MACH 4 devices are safe for mixed supply voltage system designs. The 5-V devices will not overdrive 3.3-V devices above the output voltage of 3.3 V, while they accept inputs from other 3.3-V devices. The 3.3-V device will accept inputs up to 5.5 V. Both the 5-V and 3.3-V versions have the same high-speed performance and provide easy-to-use mixed-voltage design capability.

## BUS-FRIENDLY INPUTS AND I/OS

All MACH 4 devices have inputs and I/Os which feature the Bus-Friendly circuitry incorporating two inverters in series which loop back to the input. This double inversion weakly holds the input at its last driven logic state. While it is good design practice to tie unused pins to a known state, the Bus-Friendly input structure pulls pins away from the input threshold voltage where noise can cause high-frequency switching. At power-up, the Bus-Friendly latches are reset to a logic level "1." For the circuit diagram, please refer to the document entitled *MACH Endurance Characteristics* on the Lattice/Vantis Data Book CD-ROM or Lattice web site.

## POWER MANAGEMENT

Each individual PAL block in MACH 4 devices features a programmable low-power mode, which results in power savings of up to 50%. The signal speed paths in the low-power PAL block will be slower than those in the non-low-power PAL block. This feature allows speed critical paths to run at maximum frequency while the rest of the signal paths operate in the low-power mode.

## PROGRAMMABLE SLEW RATE

Each MACH 4 device I/O has an individually programmable output slew rate control bit. Each output can be individually configured for the higher speed transition (3 V/ns) or for the lower noise transition (1 V/ns). For high-speed designs with long, unterminated traces, the slow-slew rate will introduce fewer reflections, less noise, and keep ground bounce to a minimum. For designs with short traces or well terminated lines, the fast slew rate can be used to achieve the highest speed. The slew rate is adjusted independent of power.

## POWER-UP RESET/SET

All flip-flops power up to a known state for predictable system initialization. If a macrocell is configured to SET on a signal from the control generator, then that macrocell will be SET during device power-up. If a macrocell is configured to RESET on a signal from the control generator or is not configured for set/reset, then that macrocell will RESET on power-up. To guarantee initialization values, the  $V_{CC}$  rise must be monotonic, and the clock must be inactive until the reset delay time has elapsed.

## SECURITY BIT

A programmable security bit is provided on the MACH 4 devices as a deterrent to unauthorized copying of the array configuration patterns. Once programmed, this bit defeats readback of the programmed pattern by a device programmer, securing proprietary designs from competitors. Programming and verification are also defeated by the security bit. The bit can only be reset by erasing the entire device.



Figure 16. PAL Block for MACH 4 with 2:1 Macrocell - I/O Cell Ratio



Figure 17. PAL Block for M4(LV)-32/32

17466H-042

## BLOCK DIAGRAM – M4(LV)-32/32



17466H-019

## BLOCK DIAGRAM – M4(LV)-64/32

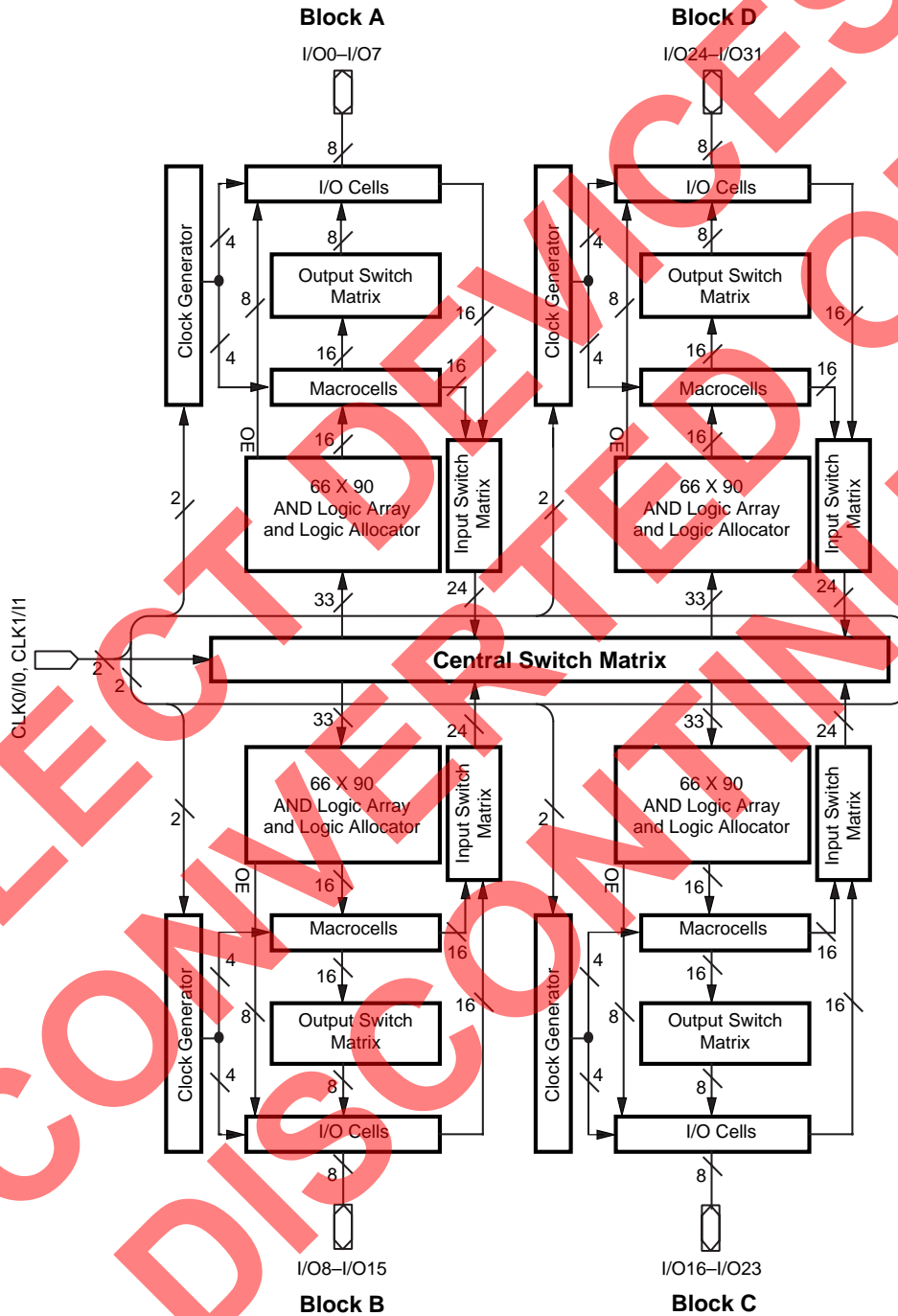

17466H-020

# BLOCK DIAGRAM – M4(LV)-96/48



17466G-021



## BLOCK DIAGRAM – M4(LV)-128N/64 AND M4(LV)-128/64



17466H-022

# BLOCK DIAGRAM – M4(LV)-192/96



17466G-067

# BLOCK DIAGRAM – M4(LV)-256/128

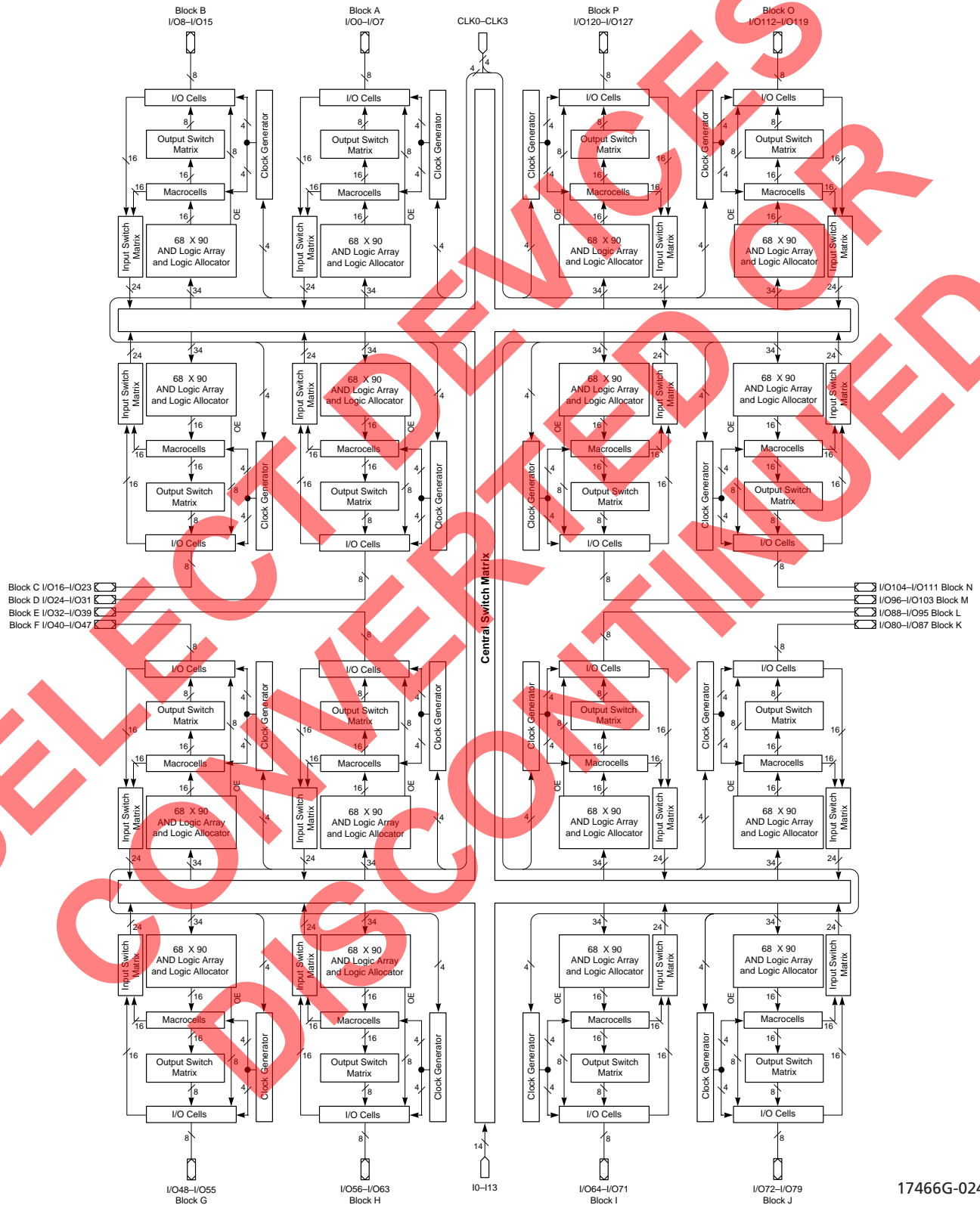

17466G-024

## ABSOLUTE MAXIMUM RATINGS

### M4

|  |                            |
|--|----------------------------|
| Storage Temperature  | -65°C to +150°C            |
| Ambient Temperature<br>with Power Applied                            | -55°C to +100°C            |
| Device Junction Temperature  | +130°C                     |
| Supply Voltage<br>with Respect to Ground                             | -0.5 V to +7.0 V           |
| DC Input Voltage   | -0.5 V to $V_{CC} + 0.5$ V |
| Static Discharge Voltage   | 2000 V                     |
| Latchup Current ( $T_A = -40^\circ\text{C}$ to $+85^\circ\text{C}$ ) | 200 mA                     |

Stresses above those listed under Absolute Maximum Ratings may cause permanent device failure. Functionality at or above these limits is not implied. Exposure to Absolute Maximum Ratings for extended periods may affect device reliability.

## OPERATING RANGES

### Commercial (C) Devices

|  |                    |
|--|--------------------|
| Ambient Temperature ( $T_A$ )<br>Operating in Free Air | 0°C to +70°C       |
| Supply Voltage ( $V_{CC}$ )<br>with Respect to Ground  | +4.75 V to +5.25 V |

### Industrial (I) Devices

|  |                   |
|--|-------------------|
| Ambient Temperature ( $T_A$ )<br>Operating in Free Air | -40°C to +85°C    |
| Supply Voltage ( $V_{CC}$ )<br>with Respect to Ground  | +4.50 V to +5.5 V |

Operating ranges define those limits between which the functionality of the device is guaranteed.

## 5-V DC CHARACTERISTICS OVER OPERATING RANGES

| Parameter Symbol | Parameter Description                 | Test Conditions  | Min | Typ | Max  | Unit          |
|------------------|---------------------------------------|--|-----|-----|------|---------------|
| $V_{OH}$         | Output HIGH Voltage                   | $I_{OH} = -3.2$ mA, $V_{CC} = \text{Min}$ , $V_{IN} = V_{IH}$ or $V_{IL}$          | 2.4 |     |      | V             |
|                  |                                       | $I_{OH} = 0$ mA, $V_{CC} = \text{Max}$ , $V_{IN} = V_{IH}$ or $V_{IL}$             |     |     | 3.3  | V             |
| $V_{OL}$         | Output LOW Voltage                    | $I_{OL} = 24$ mA, $V_{CC} = \text{Min}$ , $V_{IN} = V_{IH}$ or $V_{IL}$ (Note 1)   |     |     | 0.5  | V             |
| $V_{IH}$         | Input HIGH Voltage                    | Guaranteed Input Logical HIGH Voltage for all Inputs (Note 2)                      | 2.0 |     |      | V             |
| $V_{IL}$         | Input LOW Voltage                     | Guaranteed Input Logical LOW Voltage for all Inputs (Note 2)                       |     |     | 0.8  | V             |
| $I_{IH}$         | Input HIGH Leakage Current            | $V_{IN} = 5.25$ V, $V_{CC} = \text{Max}$ (Note 3)                                  |     |     | 10   | $\mu\text{A}$ |
| $I_{IL}$         | Input LOW Leakage Current             | $V_{IN} = 0$ V, $V_{CC} = \text{Max}$ (Note 3)                                     |     |     | -10  | $\mu\text{A}$ |
| $I_{OZH}$        | Off-State Output Leakage Current HIGH | $V_{OUT} = 5.25$ V, $V_{CC} = \text{Max}$ , $V_{IN} = V_{IH}$ or $V_{IL}$ (Note 3) |     |     | 10   | $\mu\text{A}$ |
| $I_{OZL}$        | Off-State Output Leakage Current LOW  | $V_{OUT} = 0$ V, $V_{CC} = \text{Max}$ , $V_{IN} = V_{IH}$ or $V_{IL}$ (Note 3)    |     |     | -10  | $\mu\text{A}$ |
| $I_{SC}$         | Output Short-Circuit Current          | $V_{OUT} = 0.5$ V, $V_{CC} = \text{Max}$ (Note 4)                                  | -30 |     | -160 | mA            |

### Notes:

- Total  $I_{OL}$  for one PAL block should not exceed 64 mA.
- These are absolute values with respect to device ground, and all overshoots due to system or tester noise are included.
- I/O pin leakage is the worst case of  $I_{IL}$  and  $I_{OZL}$  (or  $I_{IH}$  and  $I_{OZH}$ ).
- Not more than one output should be shorted at a time and duration of the short-circuit should not exceed one second.  $V_{OUT} = 0.5$  V has been chosen to avoid test problems caused by tester ground degradation.

## ABSOLUTE MAXIMUM RATINGS

### M4LV

|  |                  |
|--|------------------|
| Storage Temperature  | -65°C to +150°C  |
| Ambient Temperature with Power Applied                               | -55°C to +100°C  |
| Device Junction Temperature  | +130°C           |
| Supply Voltage with Respect to Ground                                | -0.5 V to +4.5 V |
| DC Input Voltage   | -0.5 V to 6.0 V  |
| Static Discharge Voltage   | 2000 V           |
| Latchup Current ( $T_A = -40^\circ\text{C}$ to $+85^\circ\text{C}$ ) | 200 mA           |

Stresses above those listed under Absolute Maximum Ratings may cause permanent device failure. Functionality at or above these limits is not implied. Exposure to Absolute Maximum Ratings for extended periods may affect device reliability.

## OPERATING RANGES

### Commercial (C) Devices

|  |                  |
|--|------------------|
| Ambient Temperature ( $T_A$ )                      |                  |
| Operating in Free Air                              | 0°C to +70°C     |
| Supply Voltage ( $V_{CC}$ ) with Respect to Ground | +3.0 V to +3.6 V |

### Industrial (I) Devices

|  |                  |
|--|------------------|
| Ambient Temperature ( $T_A$ )                      |                  |
| Operating in Free Air                              | -40°C to +85°C   |
| Supply Voltage ( $V_{CC}$ ) with Respect to Ground | +3.0 V to +3.6 V |

Operating ranges define those limits between which the functionality of the device is guaranteed.

## 3.3-V DC CHARACTERISTICS OVER OPERATING RANGES

| Parameter Symbol | Parameter Description                 | Test Conditions   | Min                         | Typ            | Max  | Unit          |
|------------------|---------------------------------------|---|-----------------------------|----------------|------|---------------|
| $V_{OH}$         | Output HIGH Voltage                   | $V_{CC} = \text{Min}$<br>$V_{IN} = V_{IH}$ or $V_{IL}$                                      | $I_{OH} = -100 \mu\text{A}$ | $V_{CC} - 0.2$ |      | V             |
|                  |                                       |   | $I_{OH} = -3.2 \text{ mA}$  | 2.4            |      | V             |
| $V_{OL}$         | Output LOW Voltage                    | $V_{CC} = \text{Min}$<br>$V_{IN} = V_{IH}$ or $V_{IL}$<br>(Note 1)                          | $I_{OL} = 100 \mu\text{A}$  |                | 0.2  | V             |
|                  |                                       |   | $I_{OL} = 24 \text{ mA}$    |                | 0.5  | V             |
| $V_{IH}$         | Input HIGH Voltage                    | Guaranteed Input Logical HIGH Voltage for all Inputs  | 2.0                         |                | 5.5  | V             |
| $V_{IL}$         | Input LOW Voltage                     | Guaranteed Input Logical LOW Voltage for all Inputs   | -0.3                        |                | 0.8  | V             |
| $I_{IH}$         | Input HIGH Leakage Current            | $V_{IN} = 3.6 \text{ V}$ , $V_{CC} = \text{Max}$ (Note 2)                                   |                             |                | 5    | $\mu\text{A}$ |
| $I_{IL}$         | Input LOW Leakage Current             | $V_{IN} = 0 \text{ V}$ , $V_{CC} = \text{Max}$ (Note 2)                                     |                             |                | -5   | $\mu\text{A}$ |
| $I_{OZH}$        | Off-State Output Leakage Current HIGH | $V_{OUT} = 3.6 \text{ V}$ , $V_{CC} = \text{Max}$<br>$V_{IN} = V_{IH}$ or $V_{IL}$ (Note 2) |                             |                | 5    | $\mu\text{A}$ |
| $I_{OZL}$        | Off-State Output Leakage Current LOW  | $V_{OUT} = 0 \text{ V}$ , $V_{CC} = \text{Max}$<br>$V_{IN} = V_{IH}$ or $V_{IL}$ (Note 2)   |                             |                | -5   | $\mu\text{A}$ |
| $I_{SC}$         | Output Short-Circuit Current          | $V_{OUT} = 0.5 \text{ V}$ , $V_{CC} = \text{Max}$ (Note 3)                                  | -15                         |                | -160 | mA            |

### Notes:

1. Total  $I_{OL}$  for one PAL block should not exceed 64 mA.
2. I/O pin leakage is the worst case of  $I_{IL}$  and  $I_{OZL}$  (or  $I_{IH}$  and  $I_{OZH}$ ).
3. Not more than one output should be shorted at a time and duration of the short-circuit should not exceed one second.

## MACH 4 TIMING PARAMETERS OVER OPERATING RANGES<sup>1</sup>

|   |   | -7  |      | -10 |      | -12 |      | -14  |      | -15  |      | -18  |      | Unit |
|---|---|-----|------|-----|------|-----|------|------|------|------|------|------|------|------|
|   |   | Min | Max  | Min | Max  | Min | Max  | Min  | Max  | Min  | Max  | Min  | Max  |      |
| <b>Combinatorial Delay:</b>                   |   |     |      |     |      |     |      |      |      |      |      |      |      |      |
| $t_{PDi}$                                     | Internal combinatorial propagation delay              |     | 5.5  |     | 8.0  |     | 10.0 |      | 12.0 |      | 13.0 |      | 16.0 | ns   |
| $t_{PD}$                                      | Combinatorial propagation delay                       |     | 7.5  |     | 10.0 |     | 12.0 |      | 14.0 |      | 15.0 |      | 18.0 | ns   |
| <b>Registered Delays:</b>                     |   |     |      |     |      |     |      |      |      |      |      |      |      |      |
| $t_{SS}$                                      | Synchronous clock setup time, D-type register         | 5.5 |      | 6.0 |      | 7.0 |      | 10.0 |      | 10.0 |      | 12.0 |      | ns   |
| $t_{SST}$                                     | Synchronous clock setup time, T-type register         | 6.5 |      | 7.0 |      | 8.0 |      | 11.0 |      | 11.0 |      | 13.0 |      | ns   |
| $t_{SA}$                                      | Asynchronous clock setup time, D-type register        | 3.5 |      | 4.0 |      | 5.0 |      | 8.0  |      | 8.0  |      | 10.0 |      | ns   |
| $t_{SAT}$                                     | Asynchronous clock setup time, T-type register        | 4.5 |      | 5.0 |      | 6.0 |      | 9.0  |      | 9.0  |      | 11.0 |      | ns   |
| $t_{HS}$                                      | Synchronous clock hold time                           | 0.0 |      | 0.0 |      | 0.0 |      | 0.0  |      | 0.0  |      | 0.0  |      | ns   |
| $t_{HA}$                                      | Asynchronous clock hold time                          | 3.5 |      | 4.0 |      | 5.0 |      | 8.0  |      | 8.0  |      | 10.0 |      | ns   |
| $t_{COsi}$                                    | Synchronous clock to internal output                  |     | 3.5  |     | 4.5  |     | 6.0  |      | 8.0  |      | 8.0  |      | 10.0 | ns   |
| $t_{COS}$                                     | Synchronous clock to output                           |     | 5.5  |     | 6.5  |     | 8.0  |      | 10.0 |      | 10.0 |      | 12.0 | ns   |
| $t_{COAi}$                                    | Asynchronous clock to internal output                 |     | 7.5  |     | 10.0 |     | 12.0 |      | 16.0 |      | 16.0 |      | 18.0 | ns   |
| $t_{COA}$                                     | Asynchronous clock to output                          |     | 9.5  |     | 12.0 |     | 14.0 |      | 18.0 |      | 18.0 |      | 20.0 | ns   |
| <b>Latched Delays:</b>                        |   |     |      |     |      |     |      |      |      |      |      |      |      |      |
| $t_{SSL}$                                     | Synchronous Latch setup time                          | 6.0 |      | 7.0 |      | 8.0 |      | 10.0 |      | 10.0 |      | 12.0 |      | ns   |
| $t_{SAL}$                                     | Asynchronous Latch setup time                         | 4.0 |      | 4.0 |      | 5.0 |      | 8.0  |      | 8.0  |      | 10.0 |      | ns   |
| $t_{HSL}$                                     | Synchronous Latch hold time                           | 0.0 |      | 0.0 |      | 0.0 |      | 0.0  |      | 0.0  |      | 0.0  |      | ns   |
| $t_{HAL}$                                     | Asynchronous Latch hold time                          | 4.0 |      | 4.0 |      | 5.0 |      | 8.0  |      | 8.0  |      | 10.0 |      | ns   |
| $t_{PDLi}$                                    | Transparent latch to internal output                  |     | 8.0  |     | 10.0 |     | 12.0 |      | 15.0 |      | 15.0 |      | 18.0 | ns   |
| $t_{PDL}$                                     | Propagation delay through transparent latch to output |     | 10.0 |     | 12.0 |     | 14.0 |      | 17.0 |      | 17.0 |      | 20.0 | ns   |
| $t_{GOSi}$                                    | Synchronous Gate to internal output                   |     | 4.0  |     | 5.5  |     | 8.0  |      | 9.0  |      | 9.0  |      | 10.0 | ns   |
| $t_{GOS}$                                     | Synchronous Gate to output                            |     | 6.0  |     | 7.5  |     | 10.0 |      | 11.0 |      | 11.0 |      | 12.0 | ns   |
| $t_{GOAi}$                                    | Asynchronous Gate to internal output                  |     | 9.0  |     | 11.0 |     | 14.0 |      | 17.0 |      | 17.0 |      | 20.0 | ns   |
| $t_{GOA}$                                     | Asynchronous Gate to output                           |     | 11.0 |     | 13.0 |     | 16.0 |      | 19.0 |      | 19.0 |      | 22.0 | ns   |
| <b>Input Register Delays:</b>                 |   |     |      |     |      |     |      |      |      |      |      |      |      |      |
| $t_{SIRS}$                                    | Input register setup time                             | 2.0 |      | 2.0 |      | 2.0 |      | 2.0  |      | 2.0  |      | 2.0  |      | ns   |
| $t_{HIRS}$                                    | Input register hold time                              | 3.0 |      | 3.0 |      | 3.0 |      | 4.0  |      | 4.0  |      | 4.0  |      | ns   |
| $t_{ICOSi}$                                   | Input register clock to internal feedback             |     | 3.5  |     | 4.5  |     | 6.0  |      | 6.0  |      | 6.0  |      | 6.0  | ns   |
| <b>Input Latch Delays:</b>                    |   |     |      |     |      |     |      |      |      |      |      |      |      |      |
| $t_{SIL}$                                     | Input latch setup time                                | 2.0 |      | 2.0 |      | 2.0 |      | 2.0  |      | 2.0  |      | 2.0  |      | ns   |
| $t_{HIL}$                                     | Input latch hold time                                 | 3.0 |      | 3.0 |      | 3.0 |      | 4.0  |      | 4.0  |      | 4.0  |      | ns   |
| $t_{IGOSi}$                                   | Input latch gate to internal feedback                 |     | 4.0  |     | 4.0  |     | 4.0  |      | 5.0  |      | 5.0  |      | 6.0  | ns   |
| $t_{PDILi}$                                   | Transparent input latch to internal feedback          |     | 2.0  |     | 2.0  |     | 2.0  |      | 2.0  |      | 2.0  |      | 2.0  | ns   |
| <b>Input Register Delays with ZHT Option:</b> |   |     |      |     |      |     |      |      |      |      |      |      |      |      |
| $t_{SIRZ}$                                    | Input register setup time - ZHT                       | 6.0 |      | 6.0 |      | 6.0 |      | 6.0  |      | 6.0  |      | 6.0  |      | ns   |
| $t_{HIRZ}$                                    | Input register hold time - ZHT                        | 0.0 |      | 0.0 |      | 0.0 |      | 0.0  |      | 0.0  |      | 0.0  |      | ns   |

## MACH 4 TIMING PARAMETERS OVER OPERATING RANGES<sup>1</sup> (CONTINUED)

|  |  | -7   |      | -10  |      | -12  |      | -14  |      | -15  |      | -18  |      | Unit |
|--|--|------|------|------|------|------|------|------|------|------|------|------|------|------|
|  |  | Min  | Max  | Min  | Max  | Min  | Max  | Min  | Max  | Min  | Max  | Min  | Max  |      |
| <b>Input Latch Delays with ZHT Option:</b> |  |      |      |      |      |      |      |      |      |      |      |      |      |      |
| $t_{SILZ}$                                 | Input latch setup time - ZHT   | 6.0  |      | 6.0  |      | 6.0  | 6.0  | 6.0  |      | 6.0  |      | 6.0  |      | ns   |
| $t_{HILZ}$                                 | Input latch hold time - ZHT  | 0.0  |      | 0.0  |      | 0.0  | 0.0  | 0.0  |      | 0.0  |      | 0.0  |      | ns   |
| $t_{PDILZI}$                               | Transparent input latch to internal feedback - ZHT                               |      | 6.0  |      | 6.0  |      | 6.0  |      | 6.0  |      | 6.0  |      | 6.0  | ns   |
| <b>Output Delays:</b>                      |  |      |      |      |      |      |      |      |      |      |      |      |      |      |
| $t_{BUF}$                                  | Output buffer delay  |      | 2.0  |      | 2.0  |      | 2.0  |      | 2.0  |      | 2.0  |      | 2.0  | ns   |
| $t_{SLW}$                                  | Slow slew rate delay adder   |      | 2.5  |      | 2.5  |      | 2.5  |      | 2.5  |      | 2.5  |      | 2.5  | ns   |
| $t_{EA}$                                   | Output enable time   |      | 9.5  |      | 10.0 |      | 12.0 |      | 15.0 |      | 15.0 |      | 17.0 | ns   |
| $t_{ER}$                                   | Output disable time  |      | 9.5  |      | 10.0 |      | 12.0 |      | 15.0 |      | 15.0 |      | 17.0 | ns   |
| <b>Power Delay:</b>                        |  |      |      |      |      |      |      |      |      |      |      |      |      |      |
| $t_{PL}$                                   | Power-down mode delay adder  |      | 2.5  |      | 2.5  |      | 2.5  |      | 2.5  |      | 2.5  |      | 2.5  | ns   |
| <b>Reset and Preset Delays:</b>            |  |      |      |      |      |      |      |      |      |      |      |      |      |      |
| $t_{SRi}$                                  | Asynchronous reset or preset to internal register output                         |      | 10.0 |      | 12.0 |      | 14.0 |      | 18.0 |      | 18.0 |      | 20.0 | ns   |
| $t_{SR}$                                   | Asynchronous reset or preset to register output                                  |      | 12.0 |      | 14.0 |      | 16.0 |      | 20.0 |      | 20.0 |      | 22.0 | ns   |
| $t_{SRR}$                                  | Asynchronous reset and preset register recovery time                             | 8.0  |      | 8.0  |      | 10.0 |      | 15.0 |      | 15.0 |      | 17.0 |      | ns   |
| $t_{SRW}$                                  | Asynchronous reset or preset width   | 10.0 |      | 10.0 |      | 12.0 |      | 15.0 |      | 15.0 |      | 17.0 |      | ns   |
| <b>Clock/LE Width:</b>                     |  |      |      |      |      |      |      |      |      |      |      |      |      |      |
| $t_{WLS}$                                  | Global clock width low   | 3.0  |      | 5.0  |      | 6.0  |      | 6.0  |      | 6.0  |      | 7.0  |      | ns   |
| $t_{WHS}$                                  | Global clock width high  | 3.0  |      | 5.0  |      | 6.0  |      | 6.0  |      | 6.0  |      | 7.0  |      | ns   |
| $t_{WLA}$                                  | Product term clock width low   | 4.0  |      | 5.0  |      | 8.0  |      | 9.0  |      | 9.0  |      | 10.0 |      | ns   |
| $t_{WHA}$                                  | Product term clock width high  | 4.0  |      | 5.0  |      | 8.0  |      | 9.0  |      | 9.0  |      | 10.0 |      | ns   |
| $t_{GWS}$                                  | Global gate width low (for low transparent) or high (for high transparent)       | 5.0  |      | 5.0  |      | 6.0  |      | 6.0  |      | 6.0  |      | 7.0  |      | ns   |
| $t_{GWA}$                                  | Product term gate width low (for low transparent) or high (for high transparent) | 4.0  |      | 5.0  |      | 6.0  |      | 9.0  |      | 9.0  |      | 11.0 |      | ns   |
| $t_{WIRL}$                                 | Input register clock width low   | 4.5  |      | 5.0  |      | 6.0  |      | 6.0  |      | 6.0  |      | 7.0  |      | ns   |
| $t_{WIRH}$                                 | Input register clock width high  | 4.5  |      | 5.0  |      | 6.0  |      | 6.0  |      | 6.0  |      | 7.0  |      | ns   |
| $t_{WIL}$                                  | Input latch gate width   | 5.0  |      | 5.0  |      | 6.0  |      | 6.0  |      | 6.0  |      | 7.0  |      | ns   |

## MACH 4 TIMING PARAMETERS OVER OPERATING RANGES<sup>1</sup> (CONTINUED)

|                   |   | -7    |     | -10   |     | -12  |     | -14  |     | -15  |     | -18  |     | Unit |
|-------------------|---|-------|-----|-------|-----|------|-----|------|-----|------|-----|------|-----|------|
|                   |   | Min   | Max | Min   | Max | Min  | Max | Min  | Max | Min  | Max | Min  | Max |      |
| <b>Frequency:</b> |   |       |     |       |     |      |     |      |     |      |     |      |     |      |
| $f_{MAXS}$        | External feedback, D-type, Min of $1/(t_{WLS} + t_{WHS})$ or $1/(t_{SS} + t_{COS})$                         | 90.9  |     | 80.0  |     | 66.7 |     | 50.0 |     | 50.0 |     | 41.7 |     | MHz  |
|                   | External feedback, T-type, Min of $1/(t_{WLS} + t_{WHS})$ or $1/(t_{SST} + t_{COS})$                        | 83.3  |     | 74.1  |     | 62.5 |     | 47.6 |     | 47.6 |     | 40.0 |     | MHz  |
|                   | Internal feedback ( $f_{CNT}$ ), D-type, Min of $1/(t_{WLS} + t_{WHS})$ or $1/(t_{SS} + t_{COSi})$          | 111.1 |     | 95.2  |     | 76.9 |     | 55.6 |     | 55.6 |     | 45.5 |     | MHz  |
|                   | Internal feedback ( $f_{CNT}$ ), T-type, Min of $1/(t_{WLS} + t_{WHS})$ or $1/(t_{SST} + t_{COSi})$         | 100.0 |     | 87.0  |     | 71.4 |     | 52.6 |     | 52.6 |     | 43.5 |     | MHz  |
|                   | No feedback <sup>2</sup> , Min of $1/(t_{WLS} + t_{WHS})$ , $1/(t_{SS} + t_{HS})$ or $1/(t_{SST} + t_{HS})$ | 153.8 |     | 100.0 |     | 83.3 |     | 83.3 |     | 83.3 |     | 71.4 |     | MHz  |
| $f_{MAXA}$        | External feedback, D-type, Min of $1/(t_{WLA} + t_{WHA})$ or $1/(t_{SA} + t_{COA})$                         | 76.9  |     | 62.5  |     | 52.6 |     | 38.5 |     | 38.5 |     | 33.3 |     | MHz  |
|                   | External feedback, T-type, Min of $1/(t_{WLA} + t_{WHA})$ or $1/(t_{SAT} + t_{COA})$                        | 71.4  |     | 58.8  |     | 50.0 |     | 37.0 |     | 37.0 |     | 32.3 |     | MHz  |
|                   | Internal feedback ( $f_{CNTA}$ ), D-type, Min of $1/(t_{WLA} + t_{WHA})$ or $1/(t_{SA} + t_{COAi})$         | 90.9  |     | 71.4  |     | 58.8 |     | 41.7 |     | 41.7 |     | 35.7 |     | MHz  |
|                   | Internal feedback ( $f_{CNTA}$ ), T-type, Min of $1/(t_{WLA} + t_{WHA})$ or $1/(t_{SAT} + t_{COAi})$        | 83.3  |     | 66.7  |     | 55.6 |     | 40.0 |     | 40.0 |     | 34.5 |     | MHz  |
|                   | No feedback <sup>2</sup> , Min of $1/(t_{WLA} + t_{WHA})$ , $1/(t_{SA} + t_{HA})$ or $1/(t_{SAT} + t_{HA})$ | 125.0 |     | 100.0 |     | 62.5 |     | 55.6 |     | 55.6 |     | 50.0 |     | MHz  |
| $f_{MAXI}$        | Maximum input register frequency, Min of $1/(t_{WIRH} + t_{WIRL})$ or $1/(t_{SIRS} + t_{HIRS})$             | 111.0 |     | 100.0 |     | 83.3 |     | 83.3 |     | 83.3 |     | 71.4 |     | MHz  |

### Notes:

- See "MACH Switching Test Circuit" document on the Literature Download page of the Lattice web site.
- This parameter does not apply to flip-flops in the emulated mode since the feedback path is required for emulation.

## CAPACITANCE<sup>1</sup>

| Parameter Symbol | Parameter Description | Test Conditions        |                           | Typ | Unit |
|------------------|-----------------------|------------------------|---------------------------|-----|------|
| $C_{IN}$         | Input capacitance     | $V_{IN}=2.0\text{ V}$  | 3.3 V or 5 V, 25°C, 1 MHz | 6   | pF   |
| $C_{VO}$         | Output capacitance    | $V_{OUT}=2.0\text{ V}$ | 3.3 V or 5 V, 25°C, 1 MHz | 8   | pF   |

### Note:

- These parameters are not 100% tested, but are calculated at initial characterization and at any time the design is modified where this parameter may be affected.



## I<sub>CC</sub> vs. FREQUENCY

These curves represent the typical power consumption for a particular device at system frequency. The selected “typical” pattern is a 16-bit up-down counter. This pattern fills the device and exercises every macrocell. Maximum frequency shown uses internal feedback and a D-type register. Power/Speed are optimized to obtain the highest counter frequency and the lowest power. The highest frequency (LSBs) is placed in common PAL blocks, which are set to high power. The lowest frequency signals (MSBs) are placed in a common PAL block and set to lowest power.



Figure 18. MACH 4 I<sub>CC</sub> Curves at High Speed Mode

17466G-066

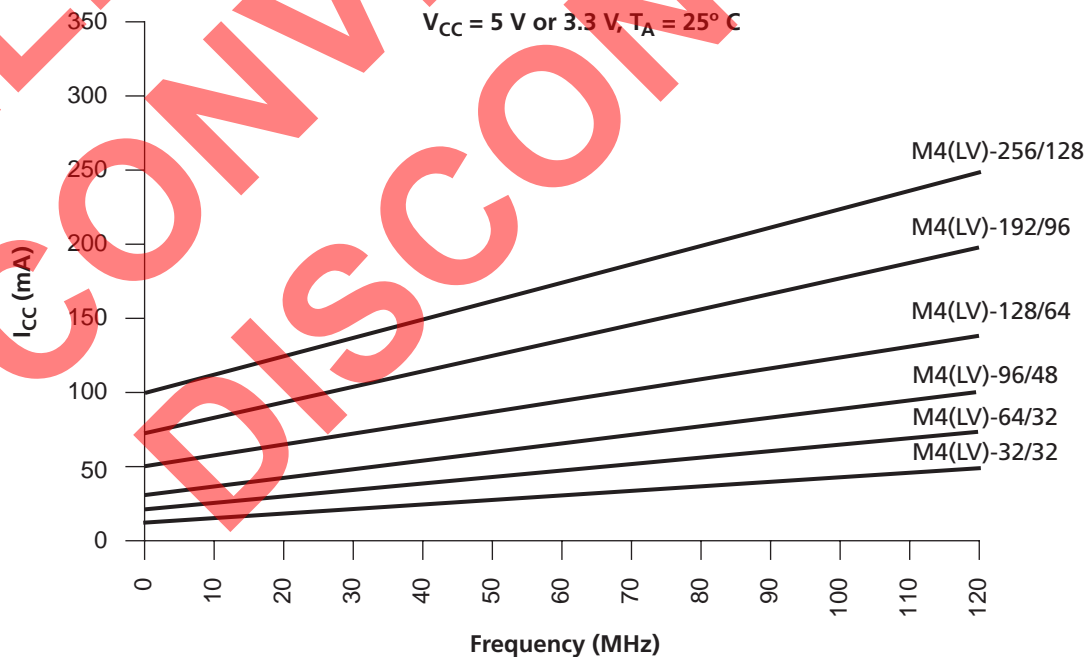
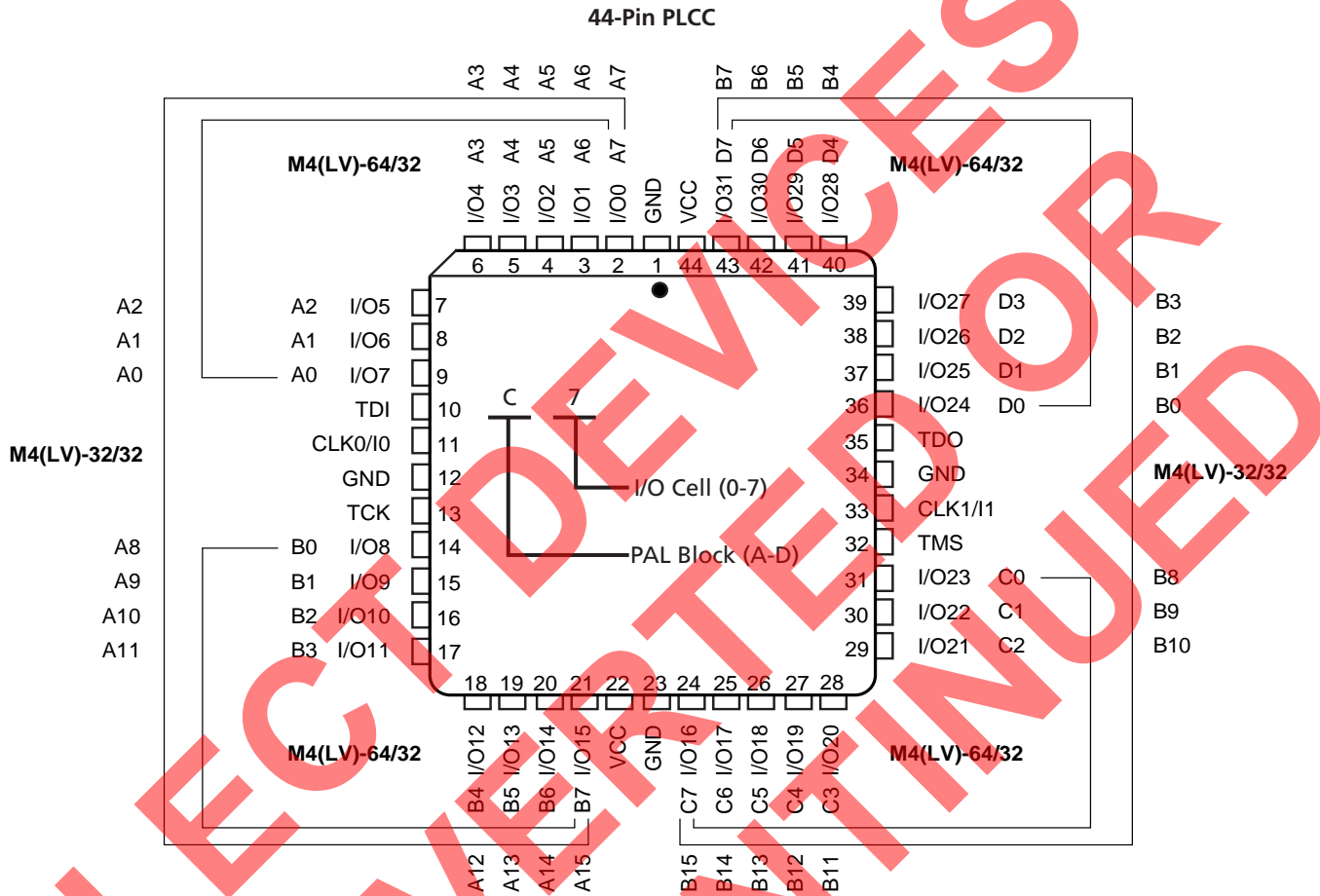

Figure 19. MACH 4 I<sub>CC</sub> Curves at Low Power Mode

17466G-065

## 44-PIN PLCC CONNECTION DIAGRAM (M4(LV)-32/32 AND M4(LV)-64/32)

### Top View



17466G-026

### PIN DESIGNATIONS

- CLK/I = Clock or Input
- GND = Ground
- I/O = Input/Output
- VCC = Supply Voltage
- TDI = Test Data In
- TCK = Test Clock
- TMS = Test Mode Select
- TDO = Test Data Out

## 44-PIN TQFP CONNECTION DIAGRAM (M4(LV)-32/32 AND M4(LV)-64/32)

### Top View



### PIN DESIGNATIONS

- CLK/I = Clock or Input
- GND = Ground
- I/O = Input/Output
- V<sub>CC</sub> = Supply Voltage
- TDI = Test Data In
- TCK = Test Clock
- TMS = Test Mode Select
- TDO = Test Data Out

## 48-PIN TQFP CONNECTION DIAGRAM (M4(LV)-32/32 AND M4(LV)-64/32)

Top View



17466G-028

### PIN DESIGNATIONS

- CLK/I = Clock or Input
- GND = Ground
- I/O = Input/Output
- V<sub>CC</sub> = Supply Voltage
- NC = No Connect
- TDI = Test Data In
- TCK = Test Clock
- TMS = Test Mode Select
- TDO = Test Data Out

## 100-PIN TQFP CONNECTION DIAGRAM (M4(LV)-96/48)

### Top View



17466G-029

### PIN DESIGNATIONS

- CLK/I = Clock or Input
- GND = Ground
- I = Input
- I/O = Input/Output
- V<sub>CC</sub> = Supply Voltage
- NC = No Connect
- TDI = Test Data In
- TCK = Test Clock
- TMS = Test Mode Select
- TDO = Test Data Out

## 84-PIN PLCC CONNECTION DIAGRAM (M4(LV)-128N/64)

### Top View



17466G-030

**Note:**

Pin-compatible with the MACH131, MACH231, MACH435.

### PIN DESIGNATIONS

- CLK/I = Clock or Input
- GND = Ground
- I = Input
- I/O = Input/Output
- VCC = Supply Voltage

## 100-PIN PQFP CONNECTION DIAGRAM (M4(LV)-128/64)

### Top View

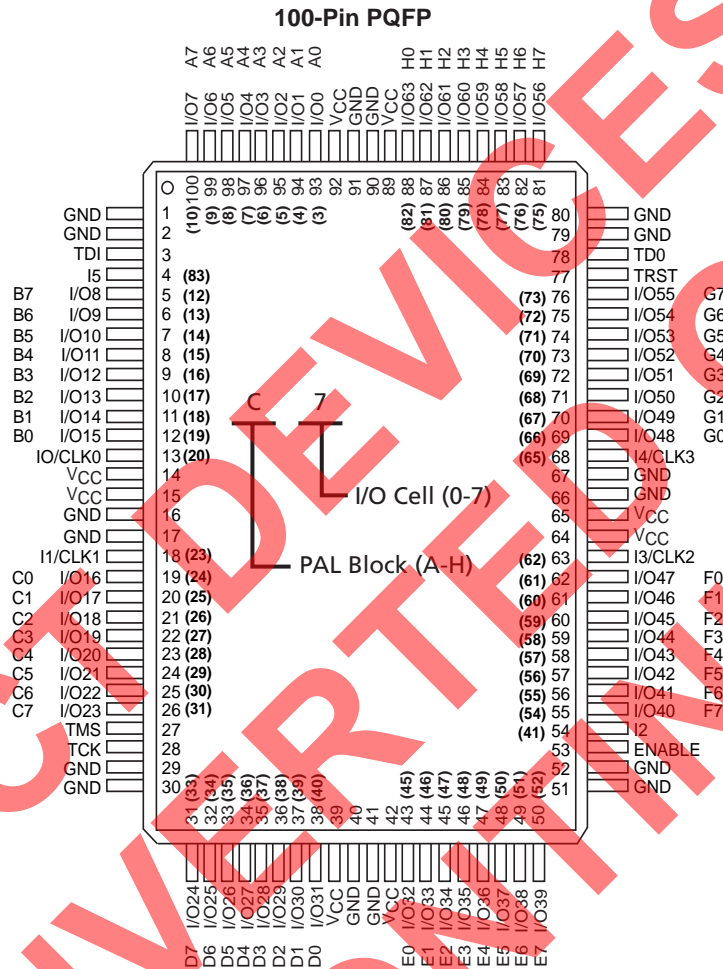

17466G-031

**Note:**

The numbers in parentheses reflect compatible pin numbers for 84-pin PLCC.

### PIN DESIGNATIONS

- I/CLK = Input or Clock
- GND = Ground
- I = Input
- I/O = Input/Output
- V<sub>CC</sub> = Supply Voltage
- TDI = Test Data In
- TCK = Test Clock
- TMS = Test Mode Select
- TDO = Test Data Out
- TRST = Test Reset
- ENABLE = Program

## 100-PIN TQFP CONNECTION DIAGRAM (M4(LV)-128/64)

### Top View



17466G-032

### PIN DESIGNATIONS

- CLK/I = Clock or Input
- GND = Ground
- I = Input
- I/O = Input/Output
- V<sub>CC</sub> = Supply Voltage
- TDI = Test Data In
- TCK = Test Clock
- TMS = Test Mode Select
- TDO = Test Data Out
- TRST = Test Reset
- ENABLE = Program



## 144-PIN TQFP CONNECTION DIAGRAM (M4(LV)-192/96)

### Top View



### PIN DESIGNATIONS

- CLK = Clock
- GND = Ground
- I = Input
- I/O = Input/Output
- V<sub>CC</sub> = Supply Voltage
- TDI = Test Data In
- TCK = Test Clock
- TMS = Test Mode Select
- TDO = Test Data Out

17466G-044

## 208-PIN PQFP CONNECTION DIAGRAM (M4(LV)-256/128)

### Top View

208-Pin PQFP



17466G-044

17466H-066

# 256-BALL BGA CONNECTION DIAGRAM (M4LV-256/128)

## Bottom View

256-Ball BGA

|   | 20        | 19        | 18        | 17        | 16   | 15        | 14        | 13        | 12       | 11  | 10  | 9        | 8        | 7        | 6        | 5        | 4        | 3        | 2        | 1        |   |
|---|-----------|-----------|-----------|-----------|--|-----------|-----------|-----------|----------|-----|-----|----------|----------|----------|----------|----------|----------|----------|----------|----------|---|
| A | GND       | N/C       | GND       | I/O108 N4 | I/O105 N1  | GND       | I/O100 M4 | I/O96 M0  | GND      | GND | GND | GND      | I/O95 L0 | I/O91 L4 | GND      | I/O87 K0 | N/C      | GND      | GND      | GND      | A |
| B | GND       | I/O113 O6 | N/C       | I/O109 N5 | I/O106 N2  | I/O103 M7 | I/O102 M6 | I/O98 M2  | N/C      | I11 | N/C | N/C      | I/O93 L2 | I/O89 L6 | I/O88 L7 | I/O85 K2 | I/O83 K6 | I/O82 K5 | N/C      | GND      | B |
| C | I/O116 O3 | N/C       | VCC       | TRST      | I/O111 N7  | I/O107 N3 | I/O104 N0 | I/O101 M5 | I/O97 M1 | N/C | I10 | I/O94 L1 | I/O90 L5 | I/O86 K1 | I/O84 K3 | I/O80 K7 | ENABLE   | VCC      | I/O78 J6 | I/O74 J2 | C |
| D | I/O120 P7 | I/O117 O2 | I/O112 O7 | VCC       | VCC  | I/O110 N6 | VCC       | N/C       | I/O99 M3 | N/C | I9  | I/O92 L3 | N/C      | VCC      | I/O81 K6 | VCC      | VCC      | I/O79 J7 | I/O75 J3 | I/O71 I7 | D |
| E | I/O123 P4 | I/O119 O0 | I/O114 O5 | TDI       | <p><b>PIN DESIGNATIONS</b></p> <ul style="list-style-type: none"> <li>CLK = Clock</li> <li>GND = Ground</li> <li>I = Input</li> <li>I/O = Input/Output</li> <li>N/C = No Connect</li> <li>VCC = Supply Voltage</li> <li>TDI = Test Data In</li> <li>TCK = Test Clock</li> <li>TMS = Test Mode Select</li> <li>TDO = Test Data Out</li> <li>TRST = Test Reset</li> <li>ENABLE = Program</li> </ul> <div style="margin-top: 10px;"> <p>I/O Cell (0-7)<br/>PAL Block (A-P)</p> </div> |           |           |           |          |     |     |          |          |          |          |          | TDO      | I/O77 J5 | I/O72 J0 | I/O68 I4 | E |
| F | GND       | I/O122 P5 | I/O118 O1 | I/O115 O4 |  |           |           |           |          |     |     |          |          |          |          |          | I/O76 J4 | I/O73 J1 | I/O69 I5 | GND      | F |
| G | I12       | I/O125 P2 | I/O121 P6 | VCC       |  |           |           |           |          |     |     |          |          |          |          |          | VCC      | I/O70 I6 | I/O65 I1 | I18      | G |
| H | GND       | I/O127 P0 | I/O126 P1 | I/O124 P3 |  |           |           |           |          |     |     |          |          |          |          |          | I/O67 I3 | I/O66 I2 | I/O64 I0 | GND      | H |
| J | N/C       | N/C       | N/C       | I13       |  |           |           |           |          |     |     |          |          |          |          |          | I7       | N/C      | N/C      | N/C      | J |
| K | GND       | CLK3      | N/C       | N/C       |  |           |           |           |          |     |     |          |          |          |          |          | N/C      | N/C      | CLK2     | N/C      | K |
| L | N/C       | CLK0      | N/C       | N/C       |  |           |           |           |          |     |     |          |          |          |          |          | N/C      | N/C      | CLK1     | GND      | L |
| M | N/C       | N/C       | N/C       | I0        |  |           |           |           |          |     |     |          |          |          |          |          | I6       | N/C      | I/O63 H0 | I/O62 H1 | M |
| N | GND       | I/O0 A0   | I/O2 A2   | I/O3 A3   |  |           |           |           |          |     |     |          |          |          |          |          | I/O60 H3 | I/O61 H2 | I/O59 H4 | GND      | N |
| P | I1        | I/O1 A1   | I/O6 A6   | VCC       |  |           |           |           |          |     |     |          |          |          |          |          | VCC      | I/O57 H6 | I/O58 H5 | I5       | P |
| R | GND       | I/O5 A5   | I/O9 B1   | N/C       | I/O51 G4   | I/O54 G1  | I/O56 H7  | GND       | R        |     |     |          |          |          |          |          |          |          |          |          |   |
| T | I/O4 A4   | I/O8 B0   | I/O12 B4  | TCK       | TMS  | I/O50 G5  | I/O55 G0  | N/C       | T        |     |     |          |          |          |          |          |          |          |          |          |   |
| U | I/O7 A7   | I/O11 B3  | I/O15 B7  | VCC       | VCC  | I/O18 C5  | VCC       | I/O24 D7  | I/O29 D2 | I2  | N/C | I/O35 E3 | N/C      | VCC      | N/C      | VCC      | VCC      | I/O48 G7 | I/O53 G2 | N/C      | U |
| V | I/O10 B2  | I/O13 B5  | VCC       | I/O16 C7  | I/O17 C6   | I/O21 C2  | I/O23 C0  | I/O27 D4  | I/O31 D0 | I3  | N/C | I/O33 E1 | I/O37 E5 | I/O41 F1 | I/O43 F3 | I/O46 F6 | I/O47 F7 | VCC      | I/O52 G3 | N/C      | V |
| W | GND       | I/O14 B6  | N/C       | N/C       | I/O19 C4   | I/O22 C1  | I/O25 D6  | I/O28 D3  | N/C      | N/C | I4  | N/C      | I/O34 E2 | I/O38 E6 | I/O39 E7 | I/O42 F2 | I/O45 F5 | N/C      | I/O49 G6 | GND      | W |
| Y | GND       | GND       | GND       | N/C       | I/O20 C3   | GND       | I/O26 D5  | I/O30 D1  | GND      | GND | GND | GND      | I/O32 E0 | I/O36 E4 | GND      | I/O40 F0 | I/O44 F4 | GND      | N/C      | GND      | Y |

17466G-045

# MACH 4 PRODUCT ORDERING INFORMATION

## MACH 4 Devices Commercial & Industrial - 3.3V and 5V

Lattice/Vantis programmable logic products are available with several ordering options. The order number (Valid Combination) is formed by a combination of:



| Valid Combinations |                   |              |
|--------------------|-------------------|--------------|
| M4-32/32           |                   | JC, VC, VC48 |
| M4LV-32/32         |                   | JC, VC, VC48 |
| M4-64/32           |                   | JC, VC, VC48 |
| M4LV-64/32         |                   | JC, VC, VC48 |
| M4-96/48           |                   | VC           |
| M4LV-96/48         |                   | VC           |
| M4-128/64          |                   | YC, VC       |
| M4LV-128/64        | -7, -10, -12, -15 | YC, VC       |
| M4-128N/64         |                   | JC           |
| M4LV-128N/64       |                   | JC           |
| M4-192/96          |                   | VC           |
| M4LV-192/96        |                   | VC           |
| M4-256/128         |                   | YC           |
| M4LV-256/128       |                   | YC, AC       |

All MACH devices are dual-marked with both Commercial and Industrial grades. The Industrial speed grade is slower, i.e., M4-256/128-7YC-10YI

| Valid Combinations |                    |              |
|--------------------|--------------------|--------------|
| M4-32/32           |                    | JI, VI, VI48 |
| M4LV-32/32         |                    | JI, VI, VI48 |
| M4-64/32           |                    | JI, VI, VI48 |
| M4LV-64/32         |                    | JI, VI, VI48 |
| M4-96/48           |                    | VI           |
| M4LV-96/48         |                    | VI           |
| M4-128/64          |                    | YI, VI       |
| M4LV-128/64        | -10, -12, -14, -18 | YI, VI       |
| M4-128N/64         |                    | JI           |
| M4LV-128N/64       |                    | JI           |
| M4-192/96          |                    | VI           |
| M4LV-192/96        |                    | VI           |
| M4-256/128         |                    | YI           |
| M4LV-256/128       |                    | YI, AI       |

### Valid Combinations

Valid Combinations list configurations planned to be supported in volume for this device. Consult the local Lattice sales office to confirm availability of specific valid combinations and to check on newly released combinations.