

Top View PLCC

**Single Color PLCC-2 Type
T680 Package 3.5mm(L) x 2.8mm(W)**

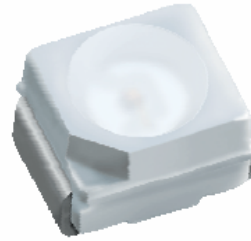

Features

Package	PLCC-2 Bathtub Type, Water clear resin.
Product Features	<ul style="list-style-type: none"> • Wide operation temperature range. Storage Temperature : -40°C~100°C Operating Temperature : -40°C~85°C Operation Guarantee • Wide viewing angle at 120° • High brightness in AllnGaP & InGaN technology • Lead-free soldering compatible • RoHS compliant
Dominant wavelength	<ul style="list-style-type: none"> • Blue: 470nm (TB) • Green: 525nm (TG) • Yellow Green: 571nm (KG) • Yellow: 589nm (KS) • Orange: 605nm (KF) • Red: 631nm (KR)
Die materials	<ul style="list-style-type: none"> • InGaN: TB, TG • AllnGaP: KG, KS, KF, KR
Viewing Angle	120°
Soldering methods	Corresponding to reflow soldering
Moisture Sensitivity Level	3
Package	<ul style="list-style-type: none"> • In 8mm tape on 7" diameter reels • 2000pcs/ reel

Recommended Applications

Indoor electronic signs and signals	<ul style="list-style-type: none"> • Contour lighting • Indoor variable message signs
Office automation, home appliances, industrial equipment	<ul style="list-style-type: none"> • Push button backlighting • Front panel backlighting • Display backlighting • Keypad and LCD backlighting
Computer, peripherals	<ul style="list-style-type: none"> • Status indicator • Logo backlighting
Telecommunications, Datacommunications	<ul style="list-style-type: none"> • Keypad and LCD backlighting • Status indicator

Color and Luminous Intensity

Lite-On P/N	Emitting color	Dice	Lens Color	Dominant Wavelength λ_d (nm)		Luminous Intensity I_v (mcd)		
				Typ.	I_F (mA)	Min.	Typ.	Max.
LTST-T680KRKT	Red	AlInGaP	Water Clear	631	20	71	140	224
LTST-T680KFKT	Orange			605		112	224	355
LTST-T680KSKT	Yellow			589		112	224	355
LTST-T680KGKT	Yellow Green			571		45	90	140
LTST-T680TGKT	Green	InGaN		525		355	600	900
LTST-T680TBKT	Blue			470		140	224	355

Note :

- The luminous intensity (I_v) and dominant wavelength (λ_d) above are the setup values of the sorting machine.
(Tolerance : $I_v \dots \pm 11\%$, $\lambda_d \dots \pm 1\text{nm}$)
- Luminous intensity is measured with a light sensor and filter combination that approximates the CIE eye-response curve.

Absolute Maximum Ratings ($T_a=25^\circ\text{C}$)

Parameter	Unit	KR	KF	KS	KG	TG	TB
Power Dissipation	mW	72	72	72	72	80	80
Peak Forward Current (1/10 Duty Cycle, 0.1ms Pulse Width)	mA	80	80	80	80	100	100
DC Forward Current	mA	30	30	30	30	20	20
Reverse Voltage ^{Note}	V	5	5	5	5	5	5
Operating Temperature Range	$^\circ\text{C}$	-40 $^\circ\text{C}$ to + 85 $^\circ\text{C}$					
Storage Temperature Range	$^\circ\text{C}$	-40 $^\circ\text{C}$ to + 100 $^\circ\text{C}$					

Note: Continuous operation with reverse voltage applied will damage the device.

Thermal Characteristics

Parameter	Unit	KR	KF	KS	KG	TG	TB
Junction Temperature (MAX.)	$^\circ\text{C}$	120	120	120	120	120	120
Thermal Resistance (TYP.) ^{Note} (Junction / Ambient)	$^\circ\text{C}/\text{W}$	500	500	500	500	500	500
Thermal Resistance (TYP.) (Junction / Solder Point)	$^\circ\text{C}/\text{W}$	280	280	280	280	280	280

Note: Mounting on FR4 PCB, pad size $\geq 16\text{ mm}^2$ per pad

Electrical / Optical Characteristics (Ta=25°C)

Lite-On P/N	Wavelength (nm)			Forward Voltage V _F (V) Note 3		Reverse Current I _r (μA)	at I _F	Viewing Angle 2Θ1/2 (deg.) Note 1
	Peak Emission λ _p (nm)	Dominant λ _d (nm) Note 2	Spectral Line Half-Width Δλ(nm)	Typ.	Max.	Max.	(mA)	
LTST-T680KRKT	639	631	20	2	2.4	10	20	120
LTST-T680KFKT	611	605	17	2	2.4	10	20	
LTST-T680KSKT	591	589	15	2	2.4	10	20	
LTST-T680KGKT	574	571	15	2	2.4	10	20	
LTST-T680TGKT	518	525	35	3.3	3.8	10	20	
LTST-T680TBKT	468	470	25	3.3	3.8	10	20	

Note:

1. Θ1/2 is the off-axis angle at which the luminous intensity is half the axial luminous intensity.
2. The dominant wavelength, λ_d is derived from the CIE chromaticity diagram and represents the single wavelength which defines the color of the device.
3. Forward Voltage Tolerance is +/- 0.1 volt.

Luminous Intensity Bin Rank

Bin Code	Min.	Max.	KR	KF	KS	KG	TG	TB
N2	35.5	45						
P1	45	56				P1		
P2	56	71						
Q1	71	90	Q1					
Q2	90	112						
R1	112	140		R1	R1	R1		
R2	140	180						R2
S1	180	224	S1					
S2	224	280						
T1	280	355		T1	T1			T1
T2	355	450					T2	
U1	450	560						
U2	560	710						
V1	710	900					V1	
V2	900	1120						

Note: Tolerance on each Intensity bin is +/-11%

Wavelength Grouping

450nm	500nm	550nm	600nm	650nm	700nm		
TB	Min.	Max.					
AC	465.0	470.0					
AD	470.0	475.0					
	TG	Min.	Max.				
	AP	520.0	525.0				
	AQ	525.0	530.0				
	AR	530.0	535.0				
		KG	Min.	Max.			
		B	564.5	567.5			
		C	567.5	570.5			
		D	570.5	573.5			
		E	573.5	576.5			
			KS	Min.	Max.		
			H	584.5	587.0		
			J	587.0	589.5		
			K	589.5	592.0		
			L	592.0	594.5		
				KF	Min.	Max.	
				P	600.0	603.0	
				Q	603.0	606.0	
				R	606.0	609.0	
				S	609.0	612.0	
					KR	Min.	Max.
					--	625.0	640.0

Note: Tolerance on each Dominate Wavelength bin is +/-1nm.

Forward Voltage (V_F) Bin Rank

Bin Code	Min.	Max.	KR	KF	KS	KG	TG	TB
D2	1.8	2.0	D2	D2	D2	D2		
D3	2.0	2.2						
D4	2.2	2.4					D7	D7
D5	2.4	2.6						
D6	2.6	2.8						
D7	2.8	3.0						
D8	3.0	3.2						
D9	3.2	3.4						
D10	3.4	3.6						
D11	3.6	3.8						
							D11	D11

Note: Forward Voltage Tolerance is +/- 0.1 volt.

Typical Electrical / Optical Characteristics Curves

Relative Intensity vs. Wavelength

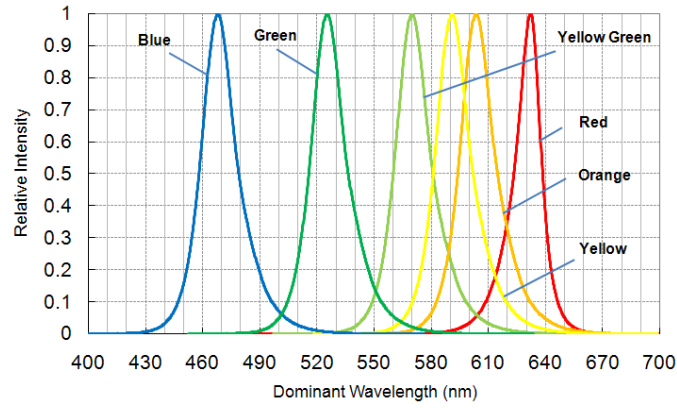

Spatial Distribution

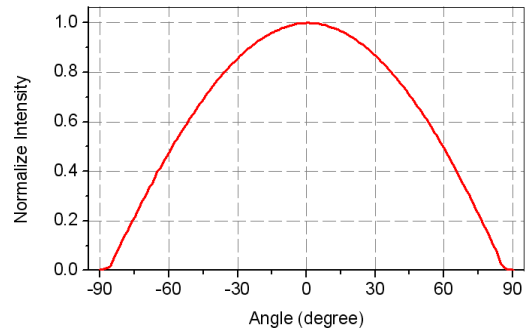
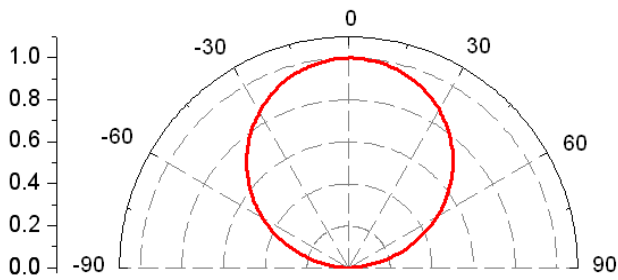

Forward Voltage vs. Forward Current

AllnGaP

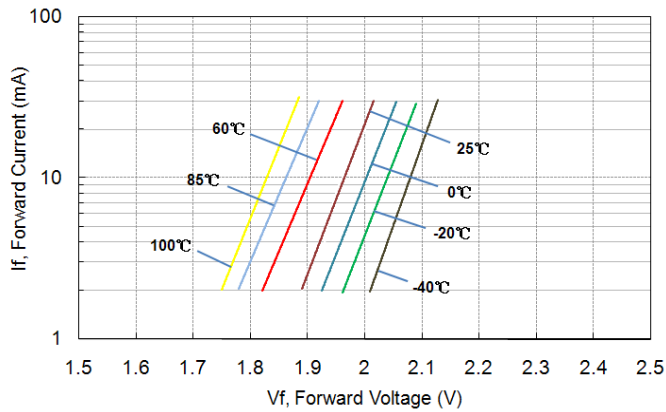

InGaN

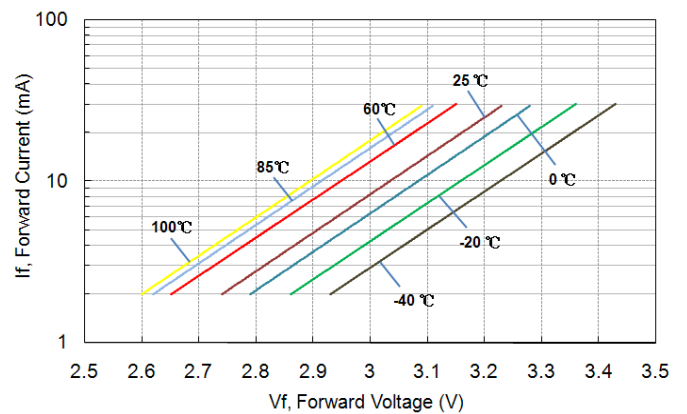

Ambient Temperature vs. Forward Voltage

AllnGaP

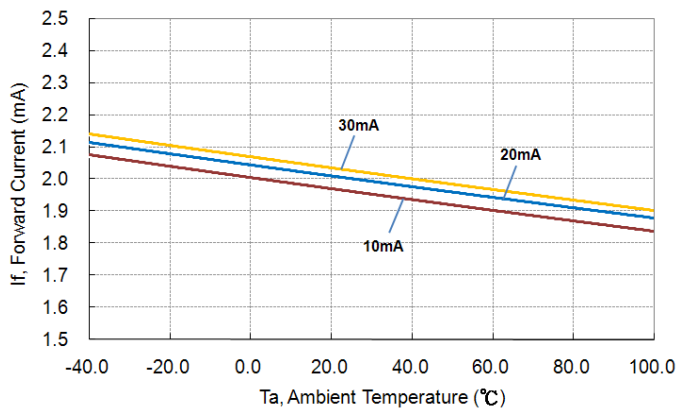

InGaN

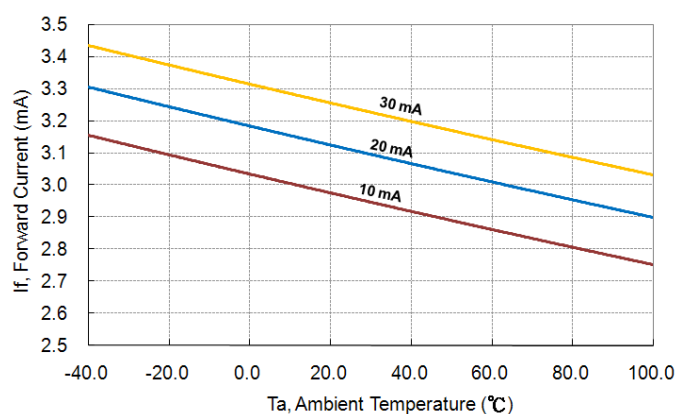

Typical Electrical / Optical Characteristics Curves

Ambient Temperature vs. Maximum Forward Current

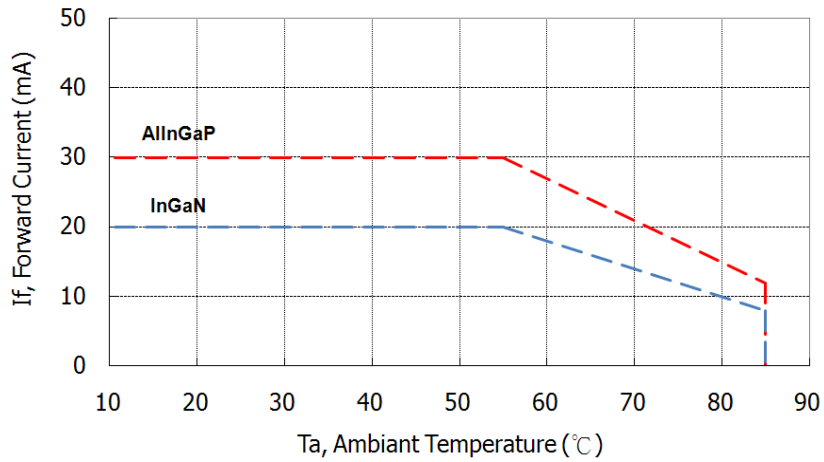

Forward Current vs. Relative Intensity

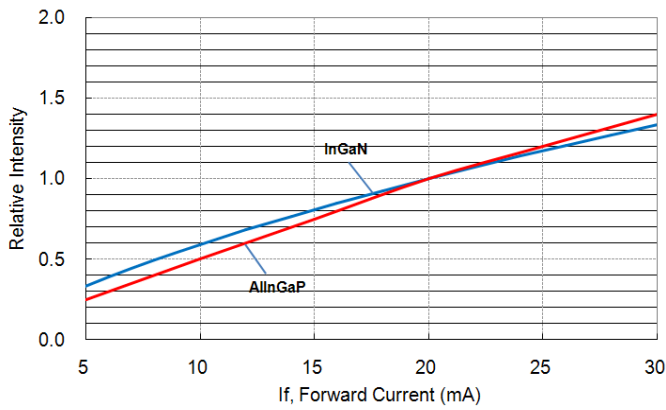

Ambient Temperature vs. Relative Intensity

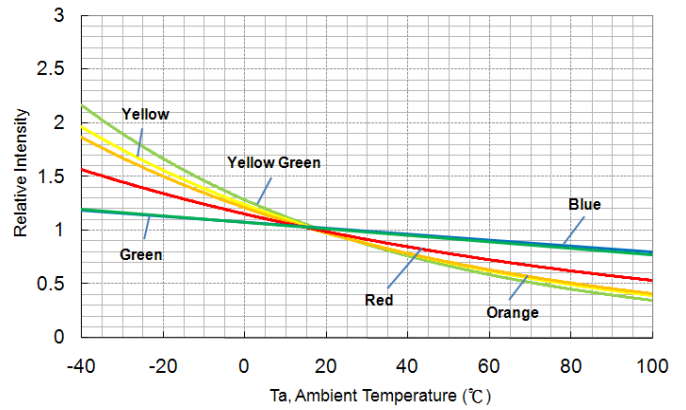

Forward Current vs. Dominant Wavelength

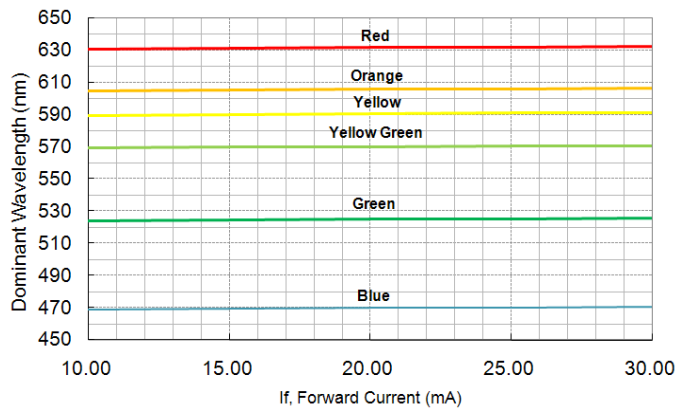

Ambient Temperature vs. Dominant Wavelength

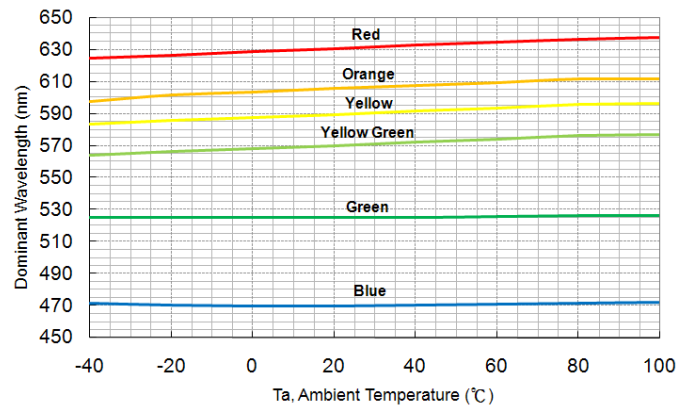

Package Dimensions

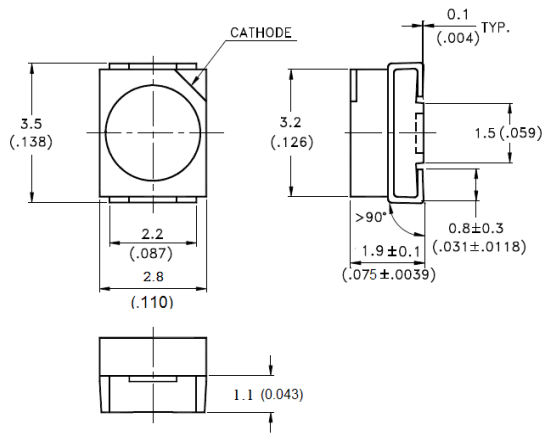

Recommended Soldering Pattern

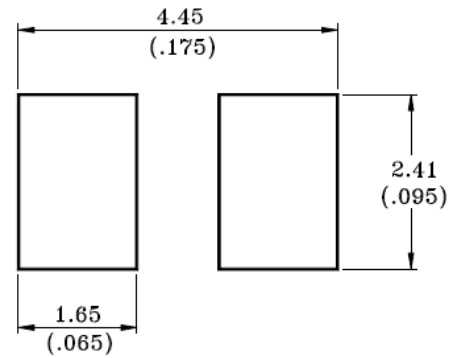

Note:

1. All dimensions are in millimeters (inches).
2. Tolerance is ± 0.2 mm (.008") unless otherwise noted.

Package Dimensions of Tape and Reel

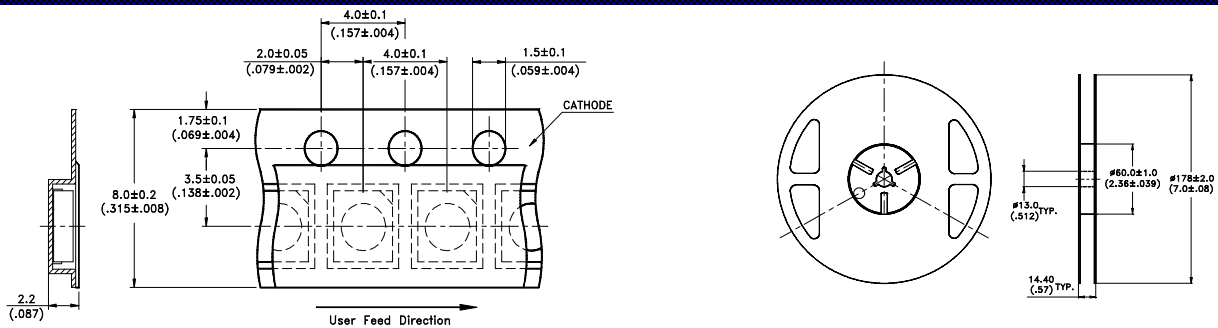

Note:

1. Empty component pockets sealed with top cover tape.
2. 7 inch reel-2000 pieces per reel.
3. Minimum packing quantity is 500 pieces for remainders.
4. The maximum number of consecutive missing lamps is two.
5. In accordance with EIA-481-1-B specifications.

IR-Reflow Soldering Profile for lead free soldering

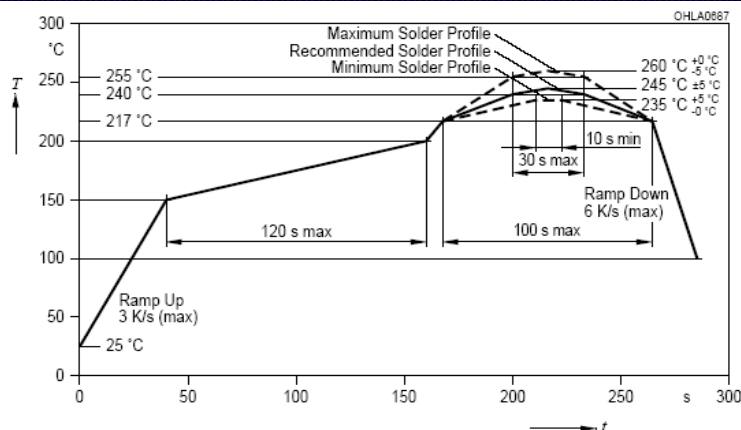

Reflow soldering conditions

Soldering iron conditions

Reflow soldering conditions		Soldering iron conditions	
Pre-heat	150~200°C	Temperature	300°C Max.
Pre-heat time	120 sec. Max	Soldering time	3 sec. Max. (one time only)
Peak temperature	260°C Max.		
Soldering time	10 sec. Max.(Max. two times)		

NOTES

No technical content pages of this document may be reproduced in any form or transmitted by any means without prior permission of Lite-On Technology Corp.

Product names and specifications in this catalog are subject to change without notice for the purpose of improvement, or manufacturing may be discontinued. When selecting to use a product, please be sure to request a delivery and specifications manual and check the contents.

When using the products described in the data sheets, please adhere to the maximum ratings for operating voltage, heat dissipation characteristics, and other precautions for use. We are not responsible for any damage which may occur if these specifications are exceeded.

Our top priority is to supply products with the utmost quality and reliability. However, there is always a chance of failure due to unexpected factors. Therefore, please take into account the derating characteristics and allow for sufficient safety features, such as extra margin, anti-flammability, and fail-safe measures when designing in order to prevent possible accidents that may result in bodily harm or fire caused by component failure. Lite-On shall bear no responsibility for any damages arising from the use of the products under conditions out of the range of the specifications or not in accordance with the instruction manual.

The products listed in this document are designed to be used with ordinary electronic equipment or devices (such as audio visual equipment, office-automation equipment, communications devices, electrical appliances and electronic toys).

The application of aircrafts, space borne application, transportation equipment, medical equipment and nuclear power control equipment, etc. needs a high reliability and safety, and the breakdown and the wrong operation might influence the life or the human body. Please consult us beforehand if you plan to use our product for the usages of aircrafts, space borne application, transportation equipment, medical equipment and nuclear power control equipment, etc. except OA equipment, telecommunications equipment, AV machine, home appliance and measuring instrument.

All efforts have been made toward the improvement of product quality and reliability; however, there is the possibility that improper methods of use could give rise to bodily injury, fire accidents, and social loss. Should there be anything unclear about the method of use, please contact our sales representative.

The most updated edition of this data sheet can be obtained from the address below:

<http://www.liteon.com/opto>



LITE-ON TECHNOLOGY CORP.

No 90, Chien I Road, Chung Ho, Taipei Hsien 235, Taiwan, R.O.C.

TEL : +886-2-2222-6181

FAX : +886-2-2221-1948

www.liteon.com

<http://www.liteon.com/opto>

© 09. 2010 LITE-ON Technology Corp. All Rights Reserved
PLCC-2 T680 Series Brochure Ver1