



# Through Hole Lamp Product Data Sheet LTW-2S3D8

Spec No.: DS20-2007-0003

Effective Date: 04/18/2015

Revision: B

**LITE-ON DCC**

**RELEASE**

BNS-OD-FC001/A4

**Through-Hole Lamp**  
**LTW-2S3D8**

Through Hole Lamp

LTW-2S3D8

Rev	Description	By	Date
Above data for PD and Customer tracking only			
-	Create new data sheet	Javy H.	02/13/2008
A	Update DS	Leo KC C.	09/21/2012
B	Update VF bins	Makha K.	04/06/2015

## Through-Hole Lamp LTW-2S3D8

### 1. Description

Through-hole white LEDs are offered in a variety of packages such as 3mm, 4mm, 5mm, rectangular and cylinder which are suitable for all applications requiring status indication. Several intensity and viewing angle choices are available in each package for design flexibility.

#### 1.1. Features

- Lead (Pb) free product - RoHS compliant
- Low power consumption & High efficiency.
- High efficiency & reliability.
- Versatile mounting on p.c. board or panel.
- I.C. compatible/low current requirement.
- Popular T-1 3/4 diameter. InGaN White & Water Clear lens

#### 1.2. Applications

- Computer
- Communication
- Consumer
- Home appliance
- Industrial

### 2. Outline Dimensions

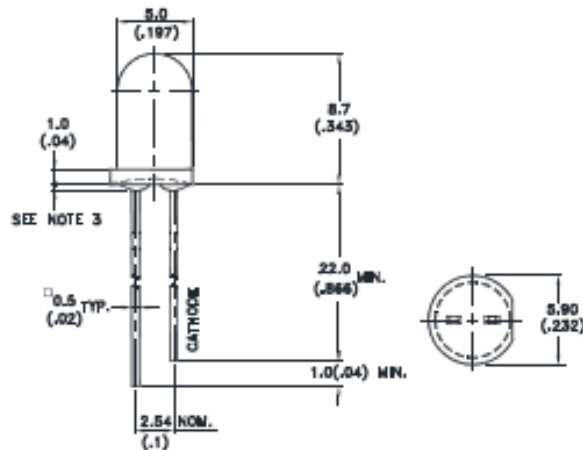

#### Notes :

1. All dimensions are in millimeters (inches).
2. Tolerance is  $\pm 0.25\text{mm}$  (.010") unless otherwise noted.
3. Protruded resin under flange is 1.0mm (.04") max.
4. Lead spacing is measured where the leads emerge from the package.
5. Specifications are subject to change without notice.

## Through-Hole Lamp LTW-2S3D8

### 3. Absolute Maximum Ratings at TA=25°C

Parameter	Maximum Rating	Unit
Power Dissipation	102	mW
Peak Forward Current (Duty Cycle $\leq$ 1/10, Pulse Width $\leq$ 10ms)	100	mA
DC Forward Current	30	mA
Derating Linear From 30°C	0.45	mA/°C
Operating Temperature Range	-40°C to + 85°C	
Storage Temperature Range	-40°C to + 100°C	
Lead Soldering Temperature [2.0mm (.079") From Body]	260°C for 5 Seconds Max.	

### 4. Electrical / Optical Characteristics at TA=25°C

Parameter	Symbol	Min.	Typ.	Max.	Unit	Test Condition
Luminous Intensity	Iv	19000	23000	29000	mcd	IF = 20mA Note 1,3,4
Viewing Angle	$2\theta_{1/2}$		15		deg	Note 2 (Fig.6)
Chromaticity Coordinates	x		0.30		nm	IF = 20mA, Note 5 Hue Spec. Table & Chromaticity Diagram
	y		0.30		nm	
Forward Voltage	VF	2.6	3.1	3.4	V	IF = 20mA
Reverse Current	IR			10	$\mu$ A	VR = 5V

#### NOTE:

- Luminous intensity is measured with a light sensor and filter combination that approximates the CIE eye-response curve.
- $\theta_{1/2}$  is the off-axis angle at which the luminous intensity is half the axial luminous intensity.
- Iv classification code is marked on each packing bag.
- The Iv guarantee must be included with  $\pm 15\%$  testing tolerance.
- The chromaticity coordinates (x, y) is derived from the 1931 CIE chromaticity diagram..
- Reverse voltage (VR) condition is applied for IR test only. The device is not designed for reverse operation.

# Through-Hole Lamp LTW-2S3D8

## 5. Typical Electrical / Optical Characteristics Curves

(25°C Ambient Temperature Unless Otherwise Noted)

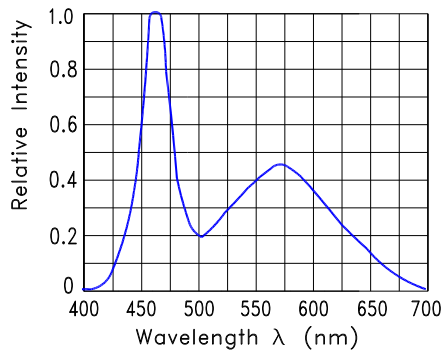

Fig.1 Relative Intensity VS. Wavelength

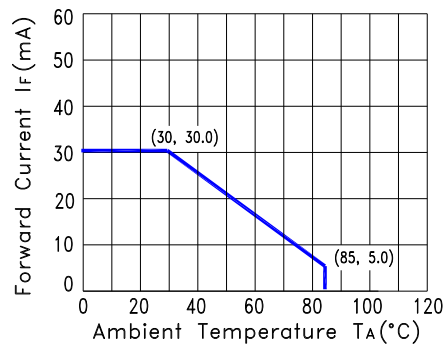

Fig.2 Forward Current Derating Curve

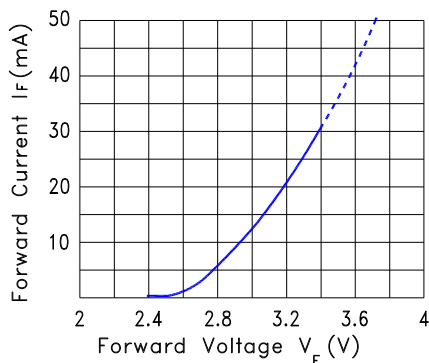

Fig.3 Forward Current vs. Forward Voltage

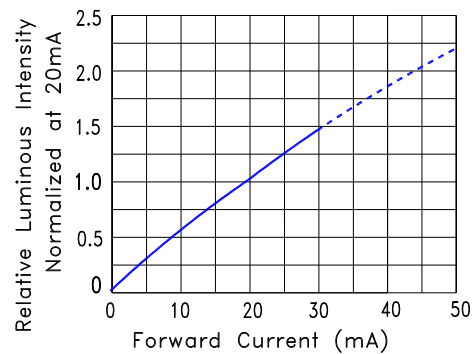

Fig.4 Relative Luminous Intensity vs. Forward Current

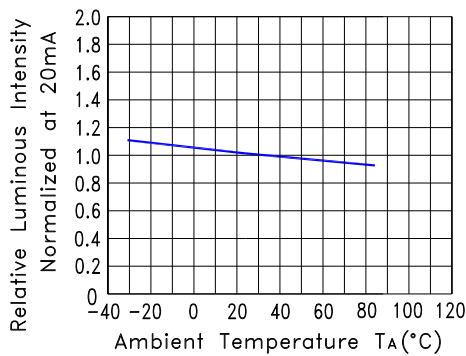

Fig.5 Relative Luminous Intensity VS. Ambient Temperature

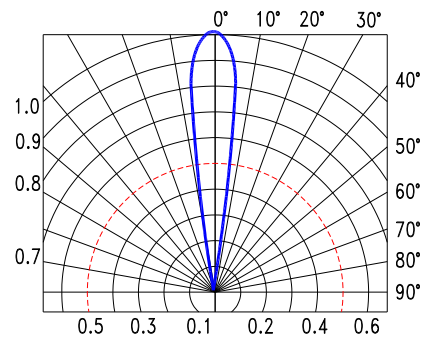
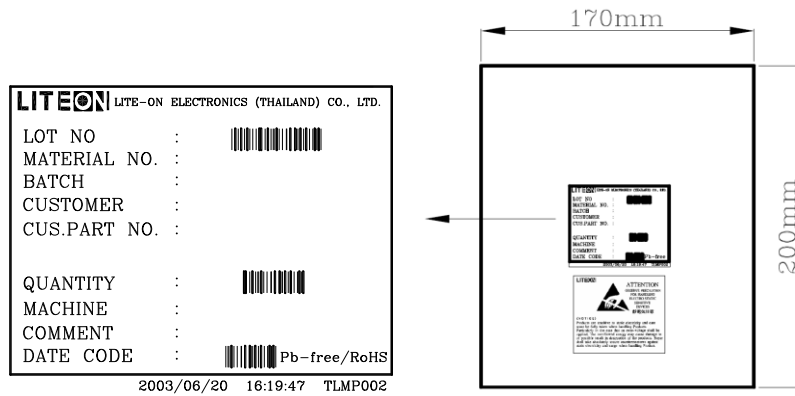

Fig.6 Spatial Distribution

## Through-Hole Lamp LTW-2S3D8

### 6. Packing Spec.

500, 200 or 100 pcs per packing bag



10 packing bags per inner carton  
Total 5,000 pcs per outer carton

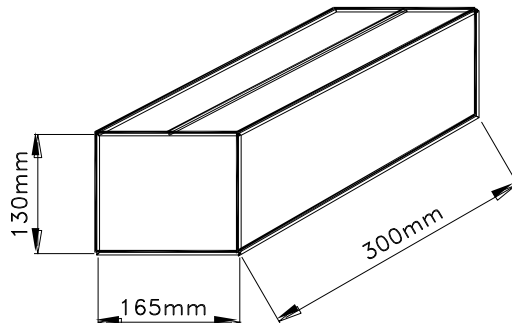

8 Inner cartons per outer carton  
Total 40,000 pcs per outer carton  
In every shipping lot, only the last pack will be non-full packing

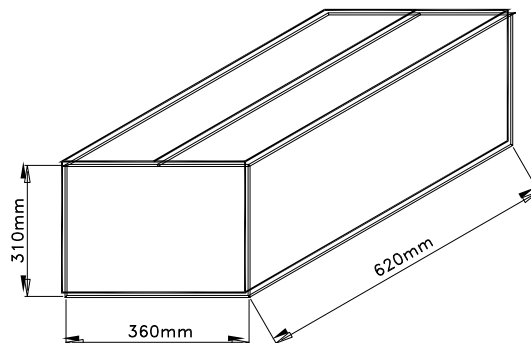

**Through-Hole Lamp**  
**LTW-2S3D8**

**7. Bin Table Specification**

Luminous Intensity Iv (mcd) IF@20mA		
Bin Code	Min.	Max.
Z1	13000	17000
Z2	17000	22000
Z3	22000	29000

Note: Tolerance of each bin limit is  $\pm 15\%$

Forward Voltage VF (V) IF@20mA		
Bin Code	Min.	Max.
0F	2.60	2.70
1F	2.70	2.80
2F	2.80	2.90
3F	2.90	3.00
4F	3.00	3.10
5F	3.10	3.20
6F	3.20	3.30
7F	3.30	3.40

Note: Forward Voltage Measurement allowance is  $\pm 0.1V$

**Through-Hole Lamp**  
**LTW-2S3D8**

Hue Ranks	Chromaticity Coordinates, CC(x, y), IF@20mA				
C0	x	0.330	0.330	0.361	0.354
	y	0.307	0.360	0.385	0.334
B4	x	0.330	0.330	0.306	0.303
	y	0.360	0.339	0.317	0.328
B6	x	0.330	0.330	0.314	0.306
	y	0.339	0.307	0.285	0.317
B3	x	0.303	0.306	0.287	0.283
	y	0.328	0.317	0.295	0.305
B5	x	0.306	0.314	0.301	0.287
	y	0.317	0.385	0.266	0.295
A0	x	0.288	0.264	0.283	0.301
	y	0.238	0.267	0.305	0.266

Note: Color Coordinates Measurement allowance is  $\pm 0.01$



**Through-Hole Lamp  
LTW-2S3D8**

C.I.E. 1931 Chromaticity Diagram

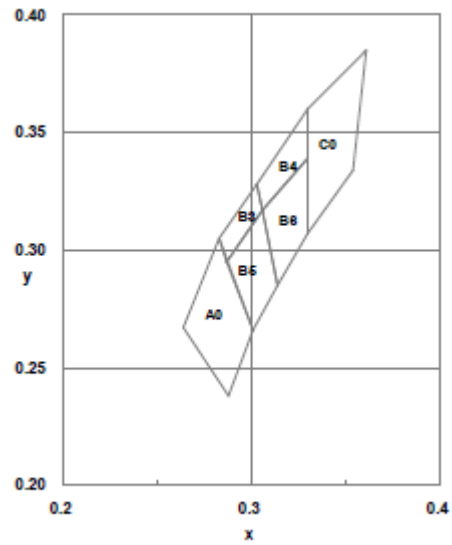
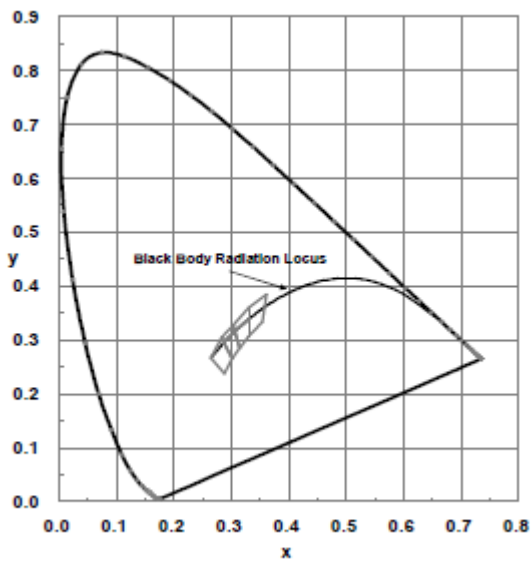

# Through-Hole Lamp LTW-2S3D8

## 8. CAUTIONS

### 8.1. Application

This LED lamp is good for application of indoor and outdoor sign, also ordinary electronic equipment.

### 8.2. Storage

The storage ambient for the LEDs should not exceed 30°C temperature or 70% relative humidity. It is recommended that LEDs out of their original packaging are used within three months. For extended storage out of their original packaging, it is recommended that the LEDs be stored in a sealed container with appropriate desiccant or in desiccators with nitrogen ambient.

### 8.3. Cleaning

Use alcohol-based cleaning solvents such as isopropyl alcohol to clean the LEDs if necessary.

### 8.4. Lead Forming & Assembly

During lead forming, the leads should be bent at a point at least 3mm from the base of LED lens. Do not use the base of the lead frame as a fulcrum during forming. Lead forming must be done before soldering, at normal temperature. During assembly on PCB, use minimum clinch force possible to avoid excessive mechanical stress.

### 8.5. Soldering

When soldering, leave a minimum of 2mm clearance from the base of the lens to the soldering point. Dipping the lens into the solder must be avoided. Do not apply any external stress to the lead frame during soldering while the LED is at high temperature.

#### Recommended soldering conditions:

Soldering iron		Wave soldering	
Temperature	350°C Max.	Pre-heat	100°C Max.
Soldering time	3 seconds Max. (one time only)	Pre-heat time	60 seconds Max.
Position	No closer than 2mm from the base of the epoxy bulb	Solder wave	260°C Max.
		Soldering time	5 seconds Max.
		Dipping Position	No lower than 2mm from the base of the epoxy bulb

Note: Excessive soldering temperature and/or time might result in deformation of the LED lens or catastrophic failure of the LED. IR reflow is not suitable process for through hole type LED lamp product.

### 8.6. Drive Method

An LED is a current-operated device. In order to ensure intensity uniformity on multiple LEDs connected in parallel in an application, it is recommended that a current limiting resistor be incorporated in the drive circuit, in series with each LED as shown in Circuit A below.

Circuit model (A)

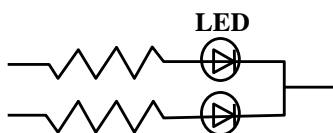

Circuit model (B)

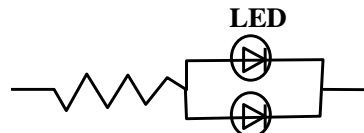

(A) Recommended circuit

(B) The brightness of each LED might appear different due to the differences in the I-V characteristics of those LEDs.

## Through-Hole Lamp LTW-2S3D8

### 8.7. ESD (Electrostatic Discharge)

#### Static Electricity or power surge will damage the LED.

##### Suggestions to prevent ESD damage:

- Use a conductive wrist band or anti- electrostatic glove when handling these LEDs
- All devices, equipment, and machinery must be properly grounded
- Work tables, storage racks, etc. should be properly grounded
- Use ion blower to neutralize the static charge which might have built up on surface of the LEDs plastic lens as a result of friction between LEDs during storage and handing

##### Suggested checking list:

##### Training and Certification

- 8.7.1.1. Everyone working in a static-safe area is ESD-certified?
- 8.7.1.2. Training records kept and re-certification dates monitored?

##### Static-Safe Workstation & Work Areas

- 8.7.2.1. Static-safe workstation or work-areas have ESD signs?
- 8.7.2.2. All surfaces and objects at all static-safe workstation and within 1 ft measure less than 100V?
- 8.7.2.3. All ionizer activated, positioned towards the units?
- 8.7.2.4. Each work surface mats grounding is good?

##### Personnel Grounding

- 8.7.3.1. Every person (including visitors) handling ESD sensitive (ESDS) items wear wrist strap, heel strap or conductive shoes with conductive flooring?
- 8.7.3.1. If conductive footwear used, conductive flooring also present where operator stand or walk?
- 8.7.3.2. Garments, hairs or anything closer than 1 ft to ESD items measure less than 100V\*?
- 8.7.3.3. Every wrist strap or heel strap/conductive shoes checked daily and result recorded for all DLs?
- 8.7.3.4. All wrist strap or heel strap checkers calibration up to date?

Note: \*50V for Blue LED.

##### Device Handling

- 8.7.4.1. Every ESDS items identified by EIA-471 labels on item or packaging?
- 8.7.4.2. All ESDS items completely inside properly closed static-shielding containers when not at static-safe workstation?
- 8.7.4.3. No static charge generators (e.g. plastics) inside shielding containers with ESDS items?
- 8.7.4.4. All flexible conductive and dissipative package materials inspected before reuse or recycle?

##### Others

- 8.7.5.1. Audit result reported to entity ESD control coordinator?
- 8.7.5.2. Corrective action from previous audits completed?
- 8.7.5.3. Are audit records complete and on file?

# Through-Hole Lamp LTW-2S3D8

## 9. Reliability Test

Classification	Test Item	Test Condition	Sample Size	Reference Standard
Endurance Test	Operation Life	Ta = Under Room Temperature IF = Per Data Sheet Maximum Rating Test Time= 1000hrs	22 PCS (CL=90%; LTPD=10%)	MIL-STD-750D:1026 MIL-STD-883G:1005
	High Temperature High Humidity storage (THB)	Ta = 60°C RH = 90% Test Time= 1000hrs	22 PCS (CL=90%; LTPD=10%)	MIL-STD-202G:103B JEITA ED-4701:100 103
	High Temperature Storage	Ta= 105 ± 5°C Test Time= 1000hrs	22 PCS (CL=90%; LTPD=10%)	MIL-STD-750D:1031 MIL-STD-883G:1008 JEITA ED-4701:200 201
	Low Temperature Storage	Ta= -55 ± 5°C Test Time= 1000hrs	22 PCS (CL=90%; LTPD=10%)	JEITA ED-4701:200 202
Environmental Test	Temperature Cycling	100°C ~ 25°C ~ -40°C ~ 25°C 30mins 5mins 30mins 5mins Test time: 30 Cycles	22 PCS (CL=90%; LTPD=10%)	MIL-STD-750D:1051 MIL-STD-883G:1010 JEITA ED-4701:100 105 JESD22-A104C
	Thermal Shock	100 ± 5°C ~ -30°C ± 5°C 15mins 15mins Test time: 30 Cycles	22 PCS (CL=90%; LTPD=10%)	MIL-STD-750D:1056 MIL-STD-883G:1011 MIL-STD-202G:107G JESD22-A106B
	Solder Resistance	T. sol = 260 ± 5°C Dwell Time= 10±1 seconds 3mm from the base of the epoxy bulb	11 PCS (CL=90%; LTPD=18.9%)	MIL-STD-750D:2031 JEITA ED-4701: 300 302
	Solderability	T. sol = 245 ± 5°C Dwell Time= 5 ± 0.5 seconds (Lead Free Solder, Coverage ≥ 95% of the dipped surface)	11 PCS (CL=90%; LTPD=18.9%)	MIL-STD-750D:2026 MIL-STD-883G:2003 MIL-STD-202G:208H IPC/EIA J-STD-002
	Soldering Iron	T. sol = 350 ± 5°C Dwell Time= 3.5 ± 0.5 seconds	11 PCS (CL=90%; LTPD=18.9%)	MIL-STD-202G:208H JEITA ED-4701:300 302

## 10. Others

White LED is materialized by combining blue LED and phosphors. Color of White LED is changed a little by an operating current.

The appearance and specifications of the product may be modified for improvement, without prior notice.