

RoHS  HF **UltraMOV™ Varistor Series**

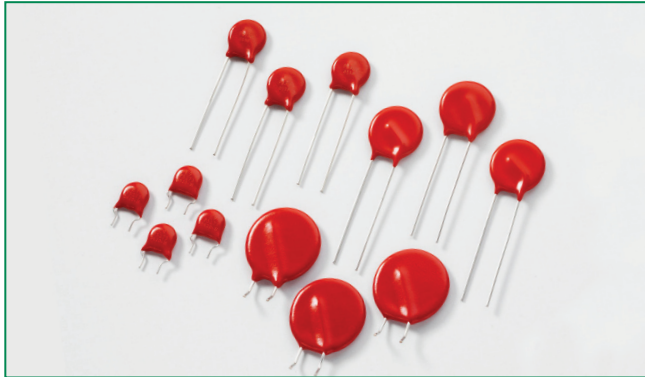





Description

The UltraMOV™ Metal Oxide Varistor Series is designed for applications requiring high peak surge current ratings and high energy absorption capability. UltraMOV™ varistors are primarily intended for use in AC Line Voltage applications such as Transient Voltage Surge Suppressors (TVSS), Uninterruptable Power Supplies (UPS), AC Power Taps, AC Power Meters, or other products that require voltage clamping of high transient surge currents from sources such as lightning, inductive load switching, or capacitor bank switching.

These devices are produced in radial lead package sizes of 7, 10, 14 and 20mm and offered in a variety of lead forms. UltraMOVs™ are manufactured with recognized epoxy encapsulation and are rated for ambient temperatures up to 85°C with no derating. This Series is LASER-branded and is supplied in bulk, ammo pack (fan-fold), or tape and reel packaging.

Agency Approvals

| Agency | Agency File Number |
|---|--------------------|
|  | E320116 |
|  | 116895 |
|  | LR91788 |
|  | 42201-006 |

Features

- Lead-free, Halogen-Free and RoHS compliant.
- High peak surge current rating (I_{TM}) up to 10kA, single 8 x 20 pulse, (20mm)
- Standard operating voltage range compatible with common AC line voltages (130 V_{AC} to 625 V_{AC})
- Characterized for maximum standby current (Leakage)
- Custom voltage types available
- Standard lead form and lead space options

ULTRAMOV™ Series

Absolute Maximum Ratings

• For ratings of individual members of a series, see Device Ratings and Specifications chart

| Continuous | UltraMOV™ Series | Units |
|--|------------------|------------|
| Steady State Applied Voltage: | | |
| DC Voltage Range ($V_{M(AC)RMS}$) | 130 to 625 | V |
| Transients: | | |
| Single-Pulse Peak Current (I_{TM}) 8x20 μ s Wave (See Figure 2) | 1,750 to 10,000 | A |
| Single-Pulse Energy Range (W_{TM}) 2ms Square Wave | 12.5 to 400 | J |
| Operating Ambient Temperature Range (T_A) | -55 to +85 | °C |
| Storage Temperature Range (T_{STG}) | -55 to +125 | °C |
| Temperature Coefficient (α^v) of Clamping Voltage (V_C) at Specified Test Current | <0.01 | %/°C |
| Hi-Pot Encapsulation (COATING Isolation Voltage Capability) | 2500 | V |
| COATING Insulation Resistance | 1000 | M Ω |

CAUTION: Stresses above those listed in "Absolute Maximum Ratings" may cause permanent damage to the device. This is a stress only rating and operation of the device at these or any other conditions above those indicated in the operational sections of this specification is not implied.

UltraMOV™ Series Ratings & Specifications

| Part Number | Branding | Maximum Rating (85°C) | | | | | Specifications (25°C) | | | | | |
|-------------|----------|-----------------------|--------------------|-----------------|---------------------------|---------------------------|---|----------------------|-----------------------------------|-----------------|---------------------|--|
| | | Continuous | | Transient | | | Varistor Voltage at 1mA DC Test Current | | Maximum Clamping Voltage 8 x 20µs | | Typical Capacitance | |
| | | RMS Volts | DC Volts | Energy 2ms | Peak Current 8 x 20µs | | | | | | | |
| | | V _{M(AC)} | V _{M(DC)} | W _{TM} | I _{TM} 1 x Pulse | I _{TM} 2 x Pulse | V _{NOM} Min | V _{NOM} Max | V _C | I _{PK} | f = 1MHz | |
| (V) | (V) | (J) | (A) | (A) | (V) | (V) | (V) | (A) | (pF) | | | |
| V07E130P | P7V130 | 130 | 170 | 12.5 | 1750 | 1200 | 184 | 226 | 340 | 10 | 180 | |
| V10E130P | P10V130 | 130 | 170 | 25 | 3500 | 2500 | 184 | 226 | 340 | 25 | 450 | |
| V14E130P | P14V130 | 130 | 170 | 50 | 6000 | 4500 | 184 | 226 | 340 | 50 | 1000 | |
| V20E130P | P20V130 | 130 | 170 | 100 | 10000 | 6500 | 184 | 226 | 340 | 100 | 1900 | |
| V07E140P | P7V140 | 140 | 180 | 13.5 | 1750 | 1200 | 200 | 240 | 360 | 10 | 160 | |
| V10E140P | P10V140 | 140 | 180 | 27.5 | 3500 | 2500 | 200 | 240 | 360 | 25 | 400 | |
| V14E140P | P14V140 | 140 | 180 | 55 | 6000 | 4500 | 200 | 240 | 360 | 50 | 900 | |
| V20E140P | P20V140 | 140 | 180 | 110 | 10000 | 6500 | 200 | 240 | 360 | 100 | 1750 | |
| V07E150P | P7V150 | 150 | 200 | 15 | 1750 | 1200 | 216 | 264 | 395 | 10 | 150 | |
| V10E150P | P10V150 | 150 | 200 | 30 | 3500 | 2500 | 216 | 264 | 395 | 25 | 360 | |
| V14E150P | P14V150 | 150 | 200 | 60 | 6000 | 4500 | 216 | 264 | 395 | 50 | 800 | |
| V20E150P | P20V150 | 150 | 200 | 120 | 10000 | 6500 | 216 | 264 | 395 | 100 | 1600 | |
| V07E175P | P7V175 | 175 | 225 | 17 | 1750 | 1200 | 243 | 297 | 455 | 10 | 130 | |
| V10E175P | P10V175 | 175 | 225 | 35 | 3500 | 2500 | 243 | 297 | 455 | 25 | 350 | |
| V14E175P | P14V175 | 175 | 225 | 70 | 6000 | 4500 | 243 | 297 | 455 | 50 | 700 | |
| V20E175P | P20V175 | 175 | 225 | 135 | 10000 | 6500 | 243 | 297 | 455 | 100 | 1400 | |
| V07E230P | P7V230 | 230 | 300 | 20 | 1750 | 1200 | 324 | 396 | 595 | 10 | 100 | |
| V10E230P | P10V230 | 230 | 300 | 42 | 3500 | 2500 | 324 | 396 | 595 | 25 | 250 | |
| V14E230P | P14V230 | 230 | 300 | 80 | 6000 | 4500 | 324 | 396 | 595 | 50 | 550 | |
| V20E230P | P20V230 | 230 | 300 | 160 | 10000 | 6500 | 324 | 396 | 595 | 100 | 1100 | |
| V07E250P | P7V250 | 250 | 320 | 25 | 1750 | 1200 | 351 | 429 | 650 | 10 | 90 | |
| V10E250P | P10V250 | 250 | 320 | 50 | 3500 | 2500 | 351 | 429 | 650 | 25 | 220 | |
| V14E250P | P14V250 | 250 | 320 | 100 | 6000 | 4500 | 351 | 429 | 650 | 50 | 500 | |
| V20E250P | P20V250 | 250 | 320 | 170 | 10000 | 6500 | 351 | 429 | 650 | 100 | 1000 | |
| V07E275P | P7V275 | 275 | 350 | 28 | 1750 | 1200 | 387 | 473 | 710 | 10 | 80 | |
| V10E275P | P10V275 | 275 | 350 | 55 | 3500 | 2500 | 387 | 473 | 710 | 25 | 200 | |
| V14E275P | P14V275 | 275 | 350 | 110 | 6000 | 4500 | 387 | 473 | 710 | 50 | 450 | |
| V20E275P | P20V275 | 275 | 350 | 190 | 10000 | 6500 | 387 | 473 | 710 | 100 | 900 | |
| V07E300P | P7V300 | 300 | 385 | 30 | 1750 | 1200 | 423 | 517 | 775 | 10 | 70 | |
| V10E300P | P10V300 | 300 | 385 | 60 | 3500 | 2500 | 423 | 517 | 775 | 25 | 180 | |
| V14E300P | P14V300 | 300 | 385 | 125 | 6000 | 4500 | 423 | 517 | 775 | 50 | 400 | |
| V20E300P | P20V300 | 300 | 385 | 250 | 10000 | 6500 | 423 | 517 | 775 | 100 | 800 | |
| V07E320P | P7V320 | 320 | 420 | 32 | 1750 | 1200 | 459 | 561 | 840 | 10 | 65 | |
| V10E320P | P10V320 | 320 | 420 | 67 | 3500 | 2500 | 459 | 561 | 840 | 25 | 170 | |
| V14E320P | P14V320 | 320 | 420 | 136 | 6000 | 4500 | 459 | 561 | 840 | 50 | 380 | |
| V20E320P | P20V320 | 320 | 420 | 273 | 10000 | 6500 | 459 | 561 | 840 | 100 | 750 | |
| V07E385P | P7V385 | 385 | 505 | 36 | 1750 | 1200 | 558 | 682 | 1025 | 10 | 60 | |
| V10E385P | P10V385 | 385 | 505 | 75 | 3500 | 2500 | 558 | 682 | 1025 | 25 | 160 | |
| V14E385P | P14V385 | 385 | 505 | 150 | 6000 | 4500 | 558 | 682 | 1025 | 50 | 360 | |
| V20E385P | P20V385 | 385 | 505 | 300 | 10000 | 6500 | 558 | 682 | 1025 | 100 | 700 | |
| V07E420P | P7V420 | 420 | 560 | 40 | 1750 | 1200 | 612 | 748 | 1120 | 10 | 55 | |
| V10E420P | P10V420 | 420 | 560 | 80 | 3500 | 2500 | 612 | 748 | 1120 | 25 | 140 | |
| V14E420P | P14V420 | 420 | 560 | 160 | 6000 | 4500 | 612 | 748 | 1120 | 50 | 300 | |
| V20E420P | P20V420 | 420 | 560 | 320 | 10000 | 6500 | 612 | 748 | 1120 | 100 | 600 | |
| V07E440P | P7V440 | 440 | 585 | 44 | 1750 | 1200 | 643 | 787 | 1180 | 10 | 50 | |
| V10E440P | P10V440 | 440 | 585 | 85 | 3500 | 2500 | 643 | 787 | 1180 | 25 | 130 | |
| V14E440P | P14V440 | 440 | 585 | 170 | 6000 | 4500 | 643 | 787 | 1180 | 50 | 260 | |
| V20E440P | P20V440 | 440 | 585 | 340 | 10000 | 6500 | 643 | 787 | 1180 | 100 | 500 | |

UltraMOV™ Series Ratings & Specifications (Continued...)

| Part Number | Branding | Maximum Rating (85°C) | | | | | Specifications (25°C) | | | | |
|-------------|----------|-----------------------|--------------------|-----------------|---------------------------|---------------------------|---|----------------------|-----------------------------------|-----------------|---------------------|
| | | Continuous | | Transient | | | Varistor Voltage at 1mA DC Test Current | | Maximum Clamping Voltage 8 x 20µs | | Typical Capacitance |
| | | RMS Volts | DC Volts | Energy 2ms | Peak Current 8 x 20µs | | | | | | |
| | | V _{M(AC)} | V _{M(DC)} | W _{TM} | I _{TM} 1 x Pulse | I _{TM} 2 x Pulse | V _{NOM} Min | V _{NOM} Max | V _C | I _{PK} | f = 1MHz |
| (V) | (V) | (J) | (A) | (A) | (V) | (V) | (V) | (A) | (pF) | | |
| V07E460P | P7V460 | 460 | 615 | 48 | 1750 | 1200 | 675 | 825 | 1240 | 10 | 45 |
| V10E460P | P10V460 | 460 | 615 | 90 | 3500 | 2500 | 675 | 825 | 1240 | 25 | 120 |
| V14E460P | P14V460 | 460 | 615 | 180 | 6000 | 4500 | 675 | 825 | 1240 | 50 | 220 |
| V20E460P | P20V460 | 460 | 615 | 360 | 10000 | 6500 | 675 | 825 | 1240 | 100 | 400 |
| V10E510P | P10V510 | 510 | 670 | 80 | 3500 | 2500 | 738 | 902 | 1355 | 25 | 110 |
| V14E510P | P14V510 | 510 | 670 | 165 | 6000 | 4500 | 738 | 902 | 1355 | 50 | 200 |
| V20E510P | P20V510 | 510 | 670 | 325 | 10000 | 6500 | 738 | 902 | 1355 | 100 | 350 |
| V10E550P | P10V550 | 550 | 745 | 90 | 3500 | 2500 | 819 | 1001 | 1500 | 25 | 100 |
| V14E550P | P14V550 | 550 | 745 | 180 | 6000 | 4500 | 819 | 1001 | 1500 | 50 | 180 |
| V20E550P | P20V550 | 550 | 745 | 360 | 10000 | 6500 | 819 | 1001 | 1500 | 100 | 300 |
| V10E625P | P10V625 | 625 | 825 | 100 | 3500 | 2500 | 900 | 1100 | 1650 | 25 | 90 |
| V14E625P | P14V625 | 625 | 825 | 200 | 6000 | 4500 | 900 | 1100 | 1650 | 50 | 160 |
| V20E625P | P20V625 | 625 | 825 | 400 | 10000 | 6500 | 900 | 1100 | 1650 | 100 | 250 |

NOTE:

1. Average power dissipation of transients should not exceed 0.25W, 0.4W, 0.6W and 1.0W for 7mm, 10mm, 14mm, and 20mm model sizes, respectively.

Power Dissipation Ratings

Should transients occur in rapid succession, the average power dissipation is the energy (watt-seconds) per pulse times the number of pulses per second. The power so developed must be within the specifications shown on the Device Ratings and Specifications Table for the specific device. Furthermore, the operating values need to be derated at high temperatures as shown in above. Because varistors can only dissipate a relatively small amount of average power they are, therefore, not suitable for repetitive applications that involve substantial amounts of average power dissipation.

Current Energy and Power Derating Curve

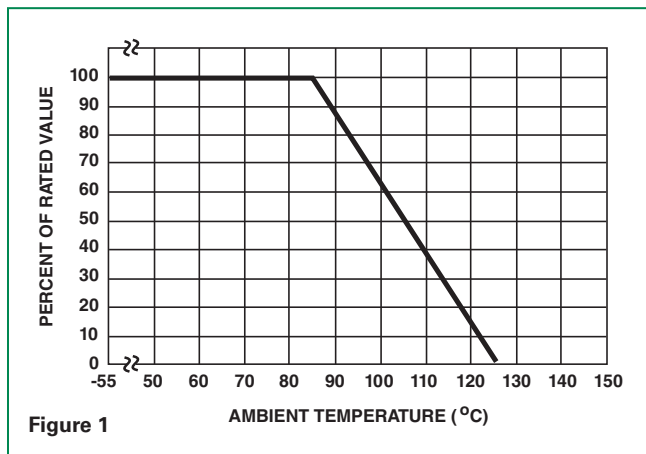

Figure 1

Peak Pulse Current Test Waveform

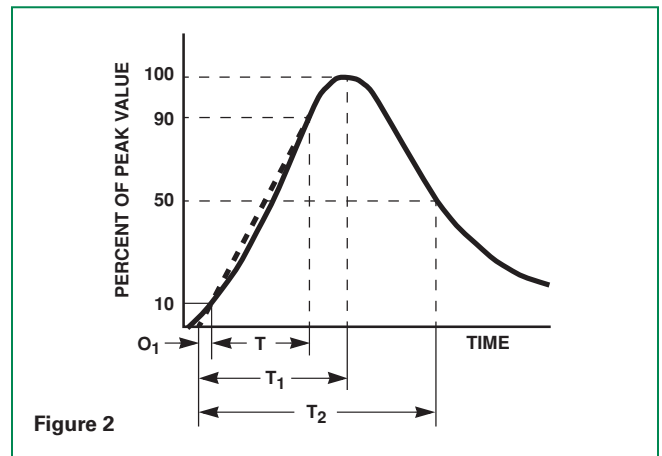

Figure 2

O₁ = Virtual Origin of Wave
 T = Time from 10% to 90% of Peak
 T₁ = Rise Time = 1.25 x T
 T₂ = Decay Time

Example - For an 8/20 µs Current Waveform:

8µs = T₁ = Rise Time
 20µs = T₂ = Decay Time

Transient V-I Characteristics Curves

Maximum Clamping Voltage for 7mm Parts

V7E130(P)-V7E460(P)

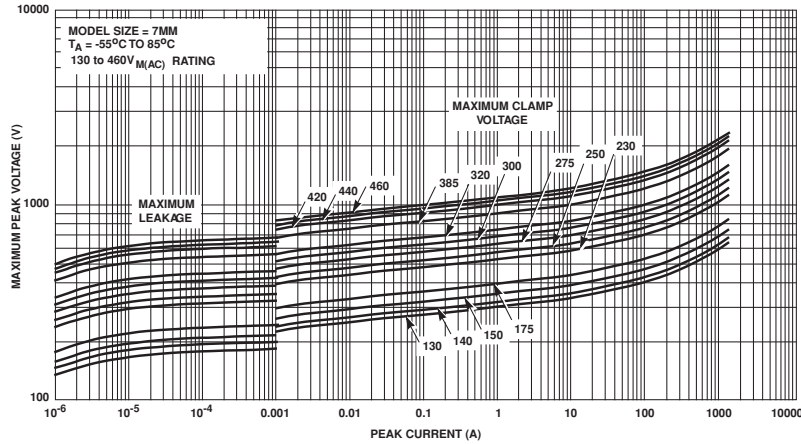

Figure 3

Maximum Clamping Voltage for 10mm Parts

V10E130(P)-V10E625(P)

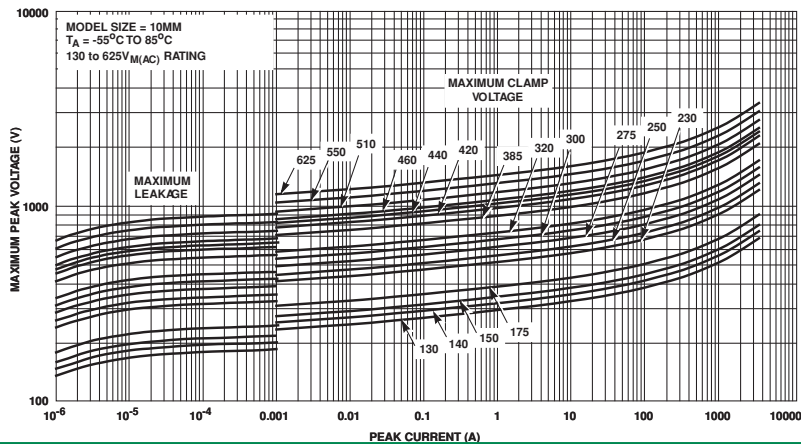

Figure 4

Maximum Clamping Voltage for 14mm Parts

V14E130(P) - V14E625(P)

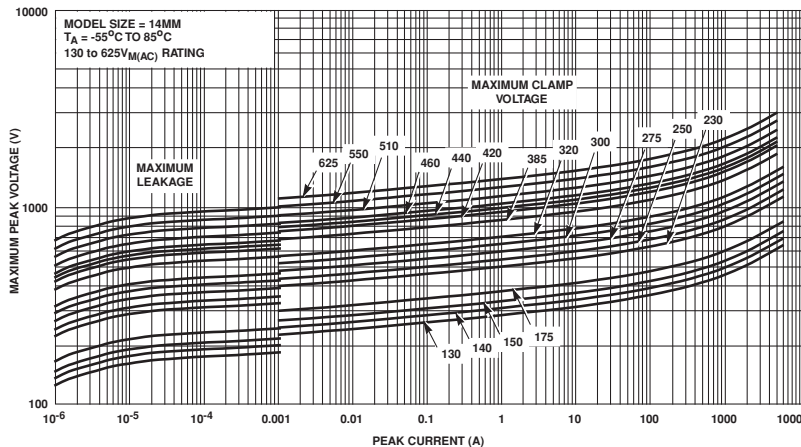
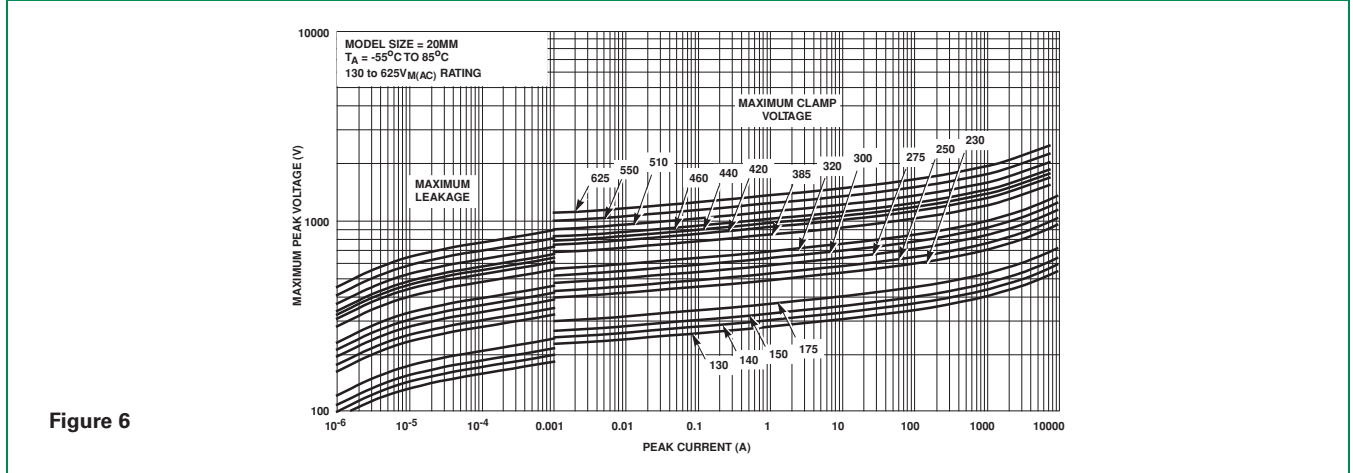

Figure 5

Transient V-I Characteristics Curves (Continued...)

Maximum Clamping Voltage for 20mm Parts

V20E130(P) - V20E625(P)



Pulse Rating Curves

Repetitive Surge Capability for 7mm Parts

V7E130(P) - V7E460(P)

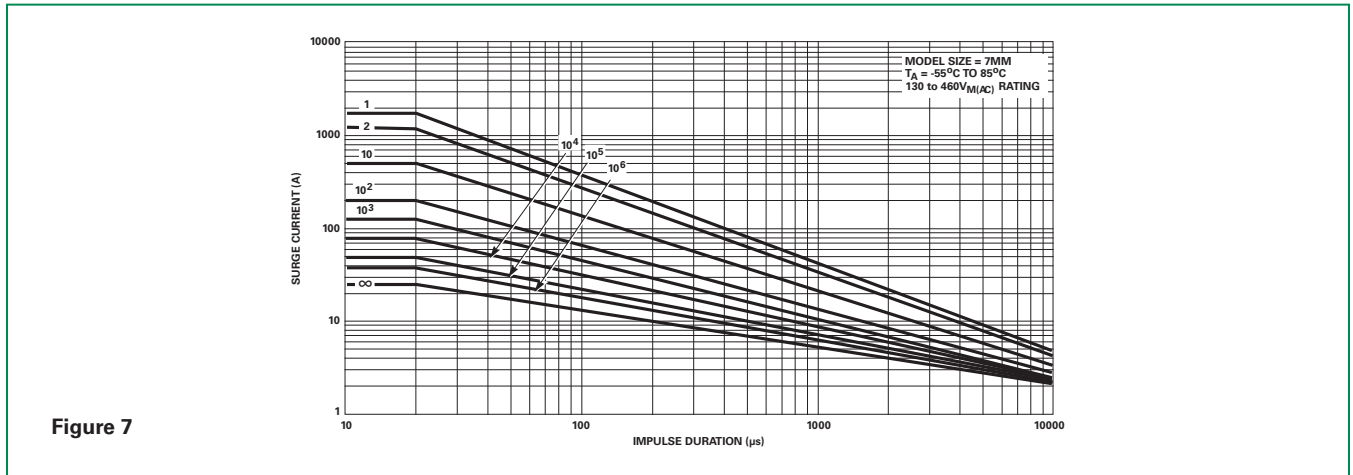

ULTRAMOV™ Series

Pulse Rating Curves (Continued...)

Repetitive Surge Capability for 10mm Parts

V10E130(P) - V10E625(P)

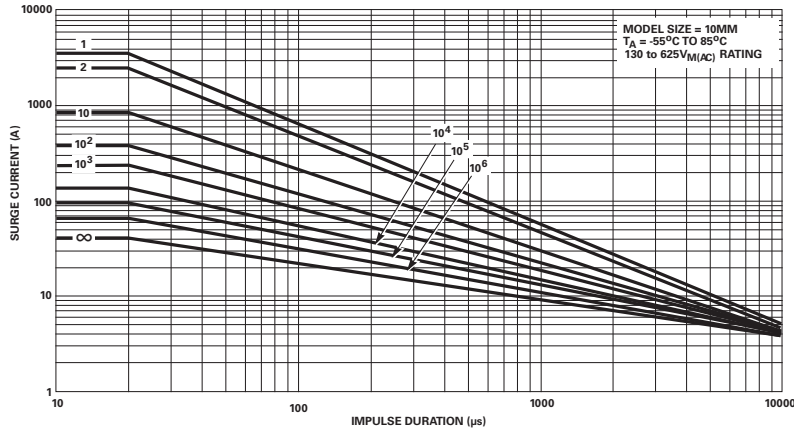

Figure 8

Repetitive Surge Capability for 14mm Parts

V14E130(P) - V14E625(P)

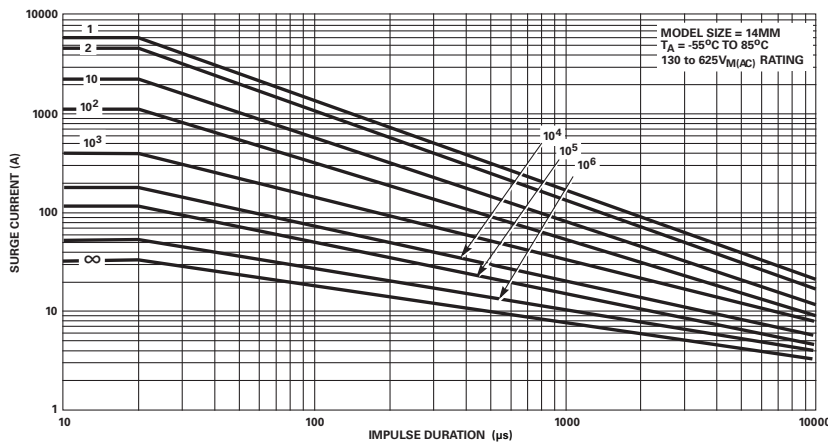

Figure 9

Repetitive Surge Capability for 20mm Parts

V20E130(P) - V20E625(P)

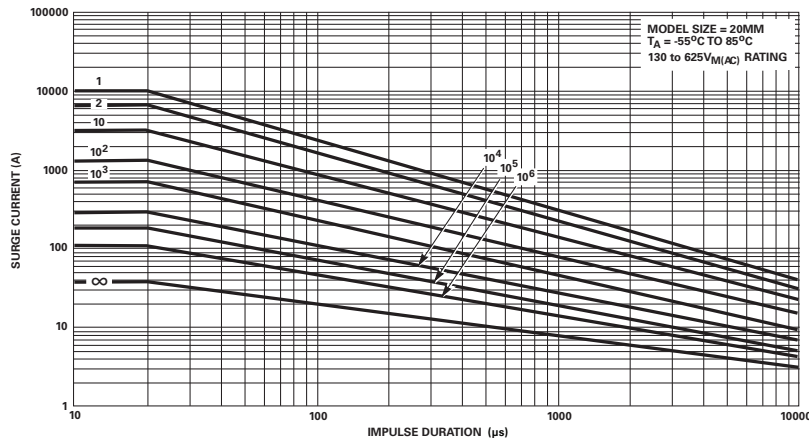

Figure 10

Wave Solder Profile

Non Lead-free Profile

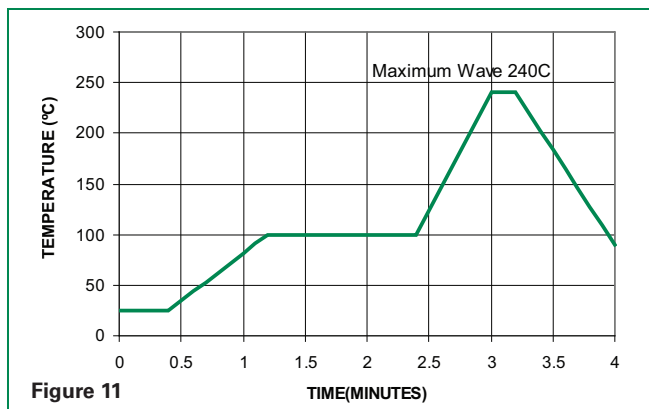

Figure 11

Lead-free Profile

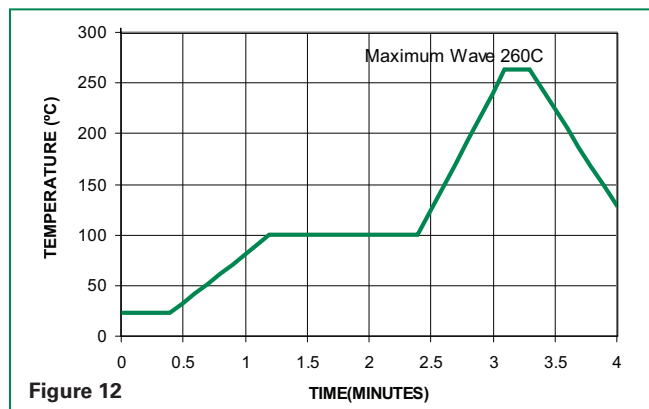

Figure 12

Physical Specifications

| | |
|----------------------------------|---|
| Lead Material | Tin-C coated Copper Wire |
| Soldering Characteristics | Solderability per MIL-STD-202, Method 208E |
| Insulating Material | Cured, flame retardant epoxy polymer meets UL94V-0 requirements |
| Device Labeling | Marked with LF, voltage, UL/CSA logos, and date code |

Environmental Specifications

| | |
|--------------------------------------|--|
| Operating/Storage Temperature | -55°C to +85°C/-55°C to +125°C |
| Humidity Aging | +85°C, 85% RH, 1000 hours +/-10% typical voltage change |
| Thermal Shock | +85°C to -40°C 5 times +/-10% typical voltage change |
| Solvent Resistance | MIL-STD-202, Method 215F |
| Moisture Sensitivity | Level 1, J-STD-020C |

ULTRAMOV™ Series

Phenolic Coating Option -- UltraMOV™ Series Varistors for Hi-Temperature Operating Conditions:

- Phenolic Coated UltraMOV™ Series devices are available with improved maximum operating temperature 125°C.
- These devices also have improved temperature cycling performance capability.
- Ratings and Specifications are as per standard UltraMOV™ Series except Hi-Pot Encapsulation (Isolation Voltage Capability) = 500V.
- Phenolic Coating is HALOGEN FREE. To order: change 'E' (Epoxy coating) in part number to 'P' (Phenolic coating; e.g. V20P230)
- See Part Numbering System section of this series for more information.
- Contact factory for further details.

Product Dimensions (mm)

Lead form options L1 and L3 (refer to table below)

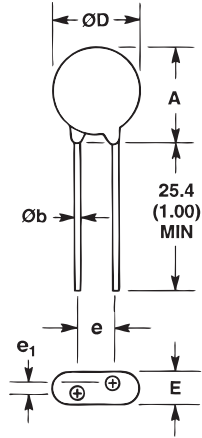

Lead form options L2 and L4 (refer to table below)

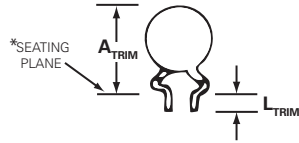

*Seating plane interpretation per IEC-717
(not available on tape or ammo pack)

| Dimension | V _{RMS} Voltage Model | 7mm Size | | 10mm Size | | 14mm Size | | 20mm Size | |
|-------------------------|--------------------------------------|------------------|------------------|-----------------|-----------------|-----------------|-----------------|--------------------------|--------------------------|
| | | Min. mm (in) | Max. mm (in) | Min. mm (in) | Max. mm (in) | Min. mm (in) | Max. mm (in) | Min. mm (in) | Max. mm (in) |
| A | 130-320 | - | 12 (0.472) | - | 16 (0.630) | - | 20 (0.787) | - | 26.5 (1.043) |
| | 385-625 | - | 13 (0.512) | - | 17 (0.689) | - | 20.5 (0.807) | - | 28 (1.102) |
| ØD | All | - | 9 (0.354) | - | 12.5 (0.492) | - | 17 (0.669) | - | 23 (0.906) |
| e (Note 2) | All | 4 (0.157) | 6 (0.236) | 6.5 (0.256) | 8.5 (0.335) | 6.5 (0.256) | 8.5 (0.335) | 9 (0.354) | 11 (0.433) |
| e ₁ (Note 3) | 130-320 | 1.5 (0.059) | 3.5 (0.138) | 1.5 (0.059) | 3.5 (0.138) | 1.5 (0.059) | 3.5 (0.138) | 1.5 (0.059) | 3.5 (0.138) |
| | 385-625 | 2.5 (0.098) | 5.5 (0.217) | 2.5 (0.098) | 5.5 (0.217) | 2.5 (0.098) | 5.5 (0.217) | 2.5 (0.098) | 5.5 (0.217) |
| E | 130-320 | - | 5.6 (0.220) | - | 5.6 (0.220) | - | 5.6 (0.220) | - | 5.6 (0.220) |
| | 385-510 | - | 7.3 (0.287) | - | 7.3 (0.287) | - | 7.3 (0.287) | - | 7.3 (0.287) |
| | 550-625 | - | 8.3 (0.327) | - | 8.3 (0.327) | - | 8.3 (0.327) | - | 8.3 (0.327) |
| ø b | All | 0.585 (0.023) | 0.685 (0.027) | 0.76 (0.030) | 0.86 (0.034) | 0.76 (0.030) | 0.86 (0.034) | 0.76 (0.030) (Note 2) | 0.86 (0.034) (Note 2) |
| A _{TRIM} | All | - | 15 (0.591) | - | 19.5 (0.768) | - | 22.5 (0.886) | - | 29.0 (1.142) |
| L (L2) | All | 25.4 (1.00) | - | 25.4 (1.00) | - | 25.4 (1.00) | - | 25.4 (1.00) | - |
| *L (L4) | All | 2.41 (0.095) | 4.69 (0.185) | 2.41 (0.095) | 4.69 (0.185) | 2.41 (0.095) | 4.69 (0.185) | 2.41 (0.095) | 4.69 (0.185) |

NOTES:

1. Measurements displayed in Millimeters (Inches in parentheses).
2. Standard lead space.
3. For in-line lead option L3, dimension e, is "zero". Straight lead form option L1 shown.

For information about bulk packaging quantities, please refer to the Ordering Notes section at the end of this document.

Tape Specifications for Reel and Ammo Pack Items (Refer to dimensions on following page)

7mm Devices

10, 14 and 20mm Devices

CRIMPED LEADS "L2"

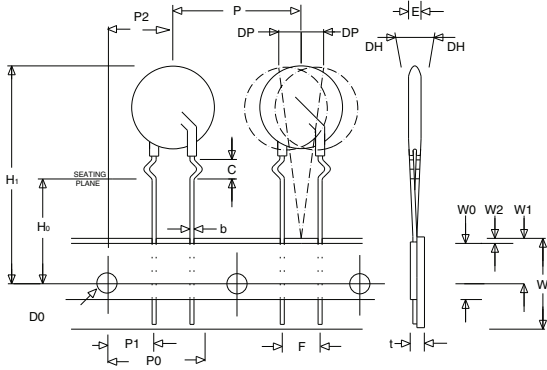

CRIMPED LEADS "L2"

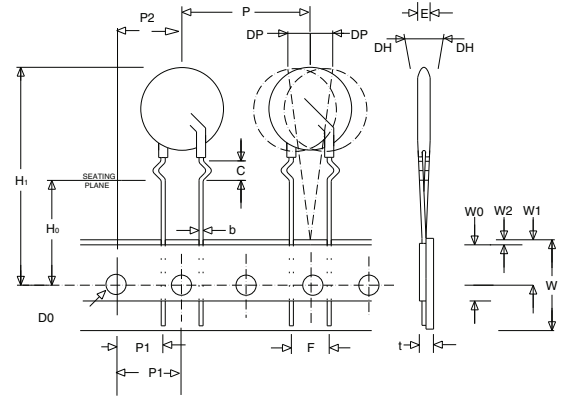

INLINE LEADS "L3"

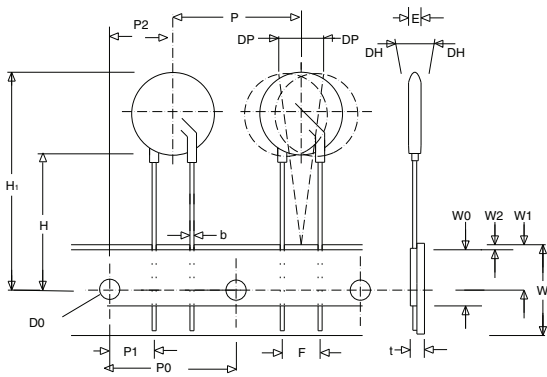

INLINE LEADS "L3"

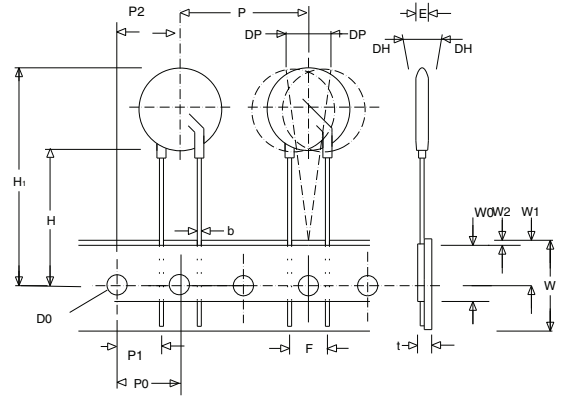

STRAIGHT LEADS "L1"

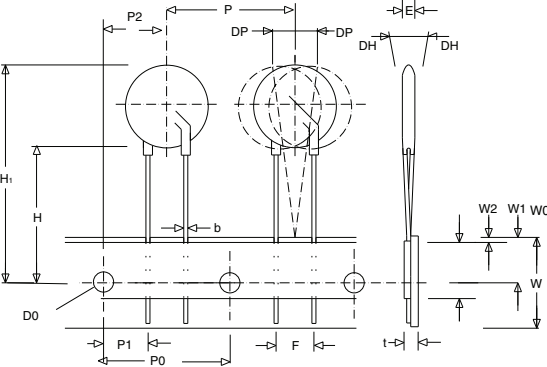

STRAIGHT LEADS "L1"

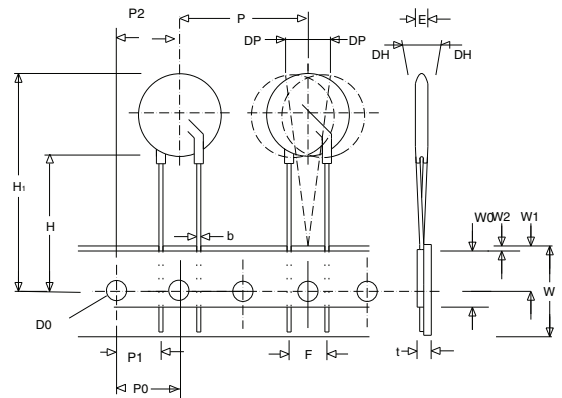

ULTRAMOV™ Series

Tape Specifications for Reel and Ammo Pack Items (Refer to drawings on previous page)

- Conforms to ANSI and EIA specifications.
- Can be supplied to IEC Publication 286-2.
- Radial devices on tape are offered with crimped leads, straight leads, or in-line leads. See Ordering Information.
- For 10mm devices 'P' (component pitch) is 12.7mm when 'F' (lead space) is 5mm.
- 7mm parts are available on tape and reel up to 460 VAC only
- 10mm parts are available on tape and reel up to 510 VAC only
- 14mm and 20mm parts are available on tape and reel up to 550 VAC only
- 7mm devices with 7.5mm lead spacing option will be taped at 25.4mm component pitch and 500 pieces per reel
- 10mm devices with 5.0mm lead spacing option will be taped at 12.7mm component pitch and 1000 pieces per reel

| Symbol | Description | Model Size | | | |
|----------------------|---|-------------------|--------------------|------------------|-------------------|
| | | 7mm | 10mm | 14mm | 20mm |
| B₁ | Component Top to Seating Plane | 15 Max | 19.5 Max | 22.5 Max | 29 Max |
| C | Crimp Length | 2.4 Typ | 2.6 Typ | 2.6 Typ | 2.6 Typ |
| P | Pitch of Component | 12.7 +/- 1.0 | 25.4 +/- 1.0 | 25.4 +/- 1.0 | 25.4 +/- 1.0 |
| P₀ | Feed Hole Pitch | 12.7 +/- 0.2 | 12.7 +/- 0.2 | 12.7 +/- 0.2 | 12.7 +/- 0.2 |
| P₁ | Feed Hole Center to Pitch | 3.85 +/- 0.7 | 8.85 +/- 0.7 | 8.85 +/- 0.7 | 7.70 +/- 0.7 |
| P₂ | Hole Center to Component Center | 6.35 +/- 0.7 | 12.7 +/- 0.7 | 12.7 +/- 0.7 | 12.7 +/- 0.7 |
| F | Lead to Lead Distance | 5.0 +/- 0.8 | 7.5 +/- 0.8 | 7.5 +/- 0.8 | 10.0 +/- 0.8 |
| Δh | Component Alignment | 2.0 Max | 2.0 Max | 2.0 Max | 2.0 Max |
| W | Tape Width | 18.0 +1.0 / -0.5 | 18.0 +1.0 / -0.52 | 18.0 +1.0 / -0.5 | 18.0 +1.0 / -0.5 |
| W₀ | Hold Down Tape Width | 12.0 +/- 0.3 | 12.0 +/- 0.3 | 12.0 +/- 0.3 | 12.0 +/- 0.3 |
| W₁ | Hole Position | 9.0 +0.75 / -0.50 | 9.0 +0.75 / - 0.50 | 9.0 +0.75 / 0.50 | 9.0 +0.75 / -0.50 |
| W₂ | Hold Down Tape Position | 0.5 Max | 0.5 Max | 0.5 Max | 0.5 Max |
| H | Height from Tape Center to Component Base | 18.0 +2.0 / -0.0 | 18.0 +2.0 / -0.0 | 18.0 +2.0 / -0.0 | 18.0 +2.0 / -0.0 |
| H₀ | Seating Plane Height | 16.0 +/- 0.5 | 16.0 +/- 0.5 | 16.0 +/- 0.5 | 16.0 +/- 0.5 |
| H₁ | Component Height | 32.0 Max | 36.0 Max | 40.0 Max | 46.5 Max |
| D₀ | Feed Hole Diameter | 4.0 +/- 0.2 | 4.0 +/- 0.2 | 4.0 +/- 0.2 | 4.0 +/- 0.2 |
| t | Total Tape Thickness | 0.7 +/- 0.2 | 0.7 +/- 0.2 | 0.7 +/- 0.2 | 0.7 +/- 0.2 |
| Δp | Component Alignment | 3° Max, 1.00mm | 3° Max, 1.00mm | 3° Max, 1.00mm | 3° Max, 1.00mm |

For information on tape and reel packaging quantities, please refer to the Ordering Notes section at the end of this document.

Part Numbering System

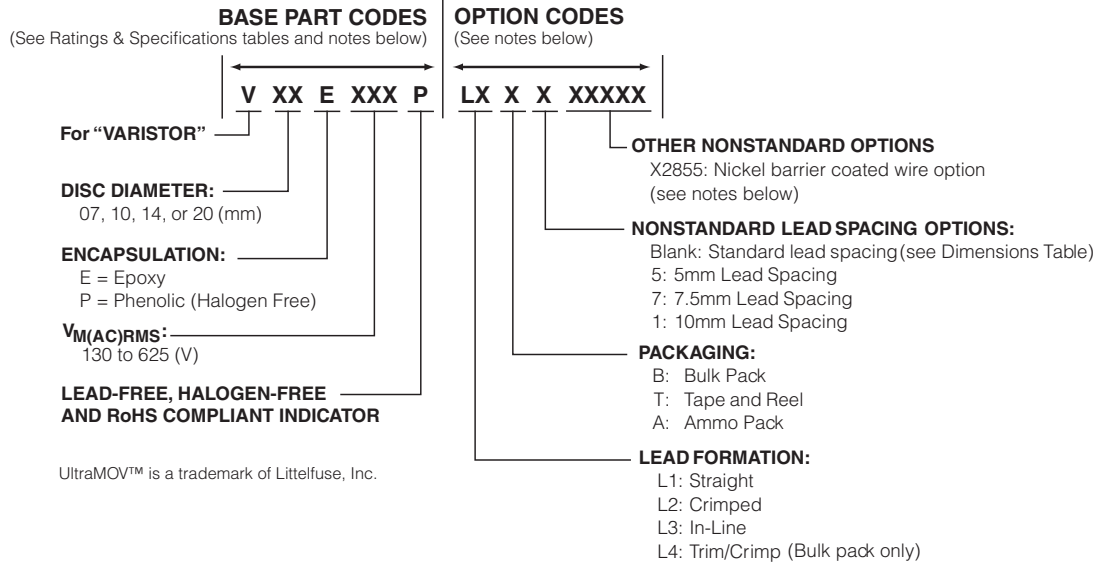

Ordering Notes:

For standard parts, use the **BASE PART** designator only.

For parts with non-standard options (such as additional form, packaging and lead space options) use, **BASE PART + OPTION CODE**.

OPTION CODE items are subject to availability and minimum order requirements. Please contact a Littelfuse representative if you require additional information

OPTION CODES:

X2855: Nickel Barrier COATED WIRE OPTION

All standard parts use Tin-coated Copper Wire Nickel Barrier Coated Wire is available as an option, consisting of Copper Wire with a flashing of Nickel followed by a top coating of Tin.

To order: append standard model **BASE PART** number with "X2855." Example:

| Standard Model | Order As |
|----------------|---------------|
| V18ZA40P | V18ZA40PX2855 |

PACKAGING:

Littelfuse UltraMOV™ varistors are shipped standard in bulk pack with straight leads and lead spacing outlined in the dimensions sections of this document. Contact a Littelfuse representative to discuss non-standard options.

Standard Part Default Conditions

| Device Size | Part # | Lead Space | Packaging |
|-------------|--------|------------|-----------|
| 7mm | V07E- | 5.0-/±1 | Bulk |
| 10mm | V10E- | 7.5-/±1 | Bulk |
| 14mm | V14E- | 7.5-/±1 | Bulk |
| 20mm | V20E- | 10.0-/±1 | Bulk |

Standard Bulk Pack Quantity

| Varistor Voltage | Standard Bulk Pack Quantity | | | |
|------------------|-----------------------------|------|------|------|
| | Varistor Model Size | | | |
| | 7mm | 10mm | 14mm | 20mm |
| 130 – 275 | 1500 | 1000 | 700 | 500 |
| 300 – 460 | 1500 | 700 | 600 | 400 |
| 510 – 625 | 1500 | 700 | 500 | 400 |

Tape & Reel Quantity

| Varistor Voltage | Shipping Quantity Per Reel | | | |
|------------------|----------------------------|------|------|------|
| | 7mm | 10mm | 14mm | 20mm |
| 130 – 275 | 1000 | 500 | 500 | 500 |
| 300 – 625 | 1000 | 500 | 400 | 400 |