

RoHS  **325/326 Series** Lead-Free 3AB, Slo-Blo® Fuse



Description

The 3AB Slo-Blo® Fuse with ceramic body construction permits higher interrupting ratings and voltage ratings. Ideal for applications where high current loads are expected.







Features

- In accordance with UL Standard 248-14
- Available in cartridge and axial lead format and with various forming dimensions
- RoHS compliant and Lead-free

Applications

Used as supplementary protection in appliance or utilization equipment to provide individual protection for components or internal circuits.







Agency Approvals

Agency	Agency File Number	Ampere Range
	E10480	250mA - 10A
	E10480	12A - 30A
	LR 29862	250mA - 30A
	NBK 030805-E10480A-F/ NBK 260106-JP1021A/B	1A - 30A
	SU05010-5012/6006/6007/7005	2.5A - 3.2A/ 7A - 30A
		10mA - 30A

Electrical Characteristics for Series

% of Ampere Rating	Ampere Rating	Opening Time
100%	100mA – 30A	4 hours, Minimum
135%	100mA – 30A	1 hour, Maximum
200%	100mA – 3.2A	5 sec., Min., 30 sec., Max.
	4A – 30A	5 sec., Min., 60 sec., Max.

Electrical Characteristic Specifications by Item

Amp Code	Ampere Rating (A)	Voltage Rating (V)	Interrupting Rating	Nominal Cold Resistance (Ohms)	Nominal Melting I ² t (A ² sec)	Agency Approvals						
												
.010	0.01	250	100A@250Vac	3324.8000	0.00148					x		
.031	0.031	250		332.5000	0.0110						x	
.062	0.062	250		91.7000	0.0276						x	
.100	0.1	250		33.5500	0.0870						x	
.125	0.125	250		22.4500	0.100						x	
.150	0.15	250		15.4500	0.143						x	
.175	0.175	250		8.9200	0.220						x	
.187	0.187	250		7.7250	0.230						x	
.200	0.2	250		6.7700	0.213						x	
.250	0.25	250		100A@250Vac 10KA@125Vac 10KA@125Vdc	4.4300	0.432			x	x	x	
.300	0.3	250	3.2200		0.690			x	x	x		
.375	0.375	250	2.1550		1.20			x	x	x		
.400	0.4	250	1.9350		1.33			x	x	x		
.500	0.5	250	1.3000		2.50			x	x	x		
.600	0.6	250	0.9495		3.90			x	x	x		
.700	0.7	250	0.7215		6.42			x	x	x		
.750	0.75	250	0.6410		7.00			x	x	x		
.800	0.8	250	0.5725		8.20			x	x	x		
001.	1	250	0.3890		16.3	x		x	x	x		
01.2	1.2	250	0.2860		22.0	x		x	x	x		
1.25	1.25	250	0.2680		24.0	x		x	x	x		
01.5	1.5	250	0.1975		40.1	x		x	x	x		
01.6	1.6	250	0.1760		45.0	x		x	x	x		
002.	2	250	0.1210		80.0	x		x	x	x		
02.5	2.5	250	0.0835		136.0	x		x	x	x	x	
02.8	2.8	250	0.0695		170.0	x		x	x	x	x	
003.	3	250	0.0605		200.0	x		x	x	x	x	
03.2	3.2	250	100A@250Vac 100KA@125Vac		0.0539	214.0	x		x	x	x	x
004.	4	250	400A@250Vac 10KA@125Vac		0.0761	9.71	x		x	x	x	
005.	5	250		0.0522	25.0	x		x	x	x		
6.25	6.25	250		0.0346	60.4	x		x	x	x		
007.	7	250		0.0227	47.3	x		x	x	x	x	
008.	8	250		0.0193	67.1	x		x	x	x	x	
010.	10	250		0.0132	137	x		x	x	x	x	
012.	12	250	400A@250Vac 10KA@125Vac 500A@60Vdc	0.0067	129	x	x	x		x	x	
012.*	12	250		0.0011	445		x	x		x		
015.	15	250		0.0050	245	x	x	x		x	x	
015.*	15	250		0.0083	760		x	x		x		
020.	20	250		0.0034	575	x	x	x		x	x	
020.*	20	250		0.0042	1900		x	x		x		
025.	25	125	400A@125Vac 10KA@60Vdc	0.0024	1030	x	x	x		x	x	
030.	30	125	600A@125Vdc	0.0019	1690	x	x	x		x	x	

*Higher I²t version available. 0325020.MXDP nominal I²t is 2507 A² Sec

Temperature Derating Curve

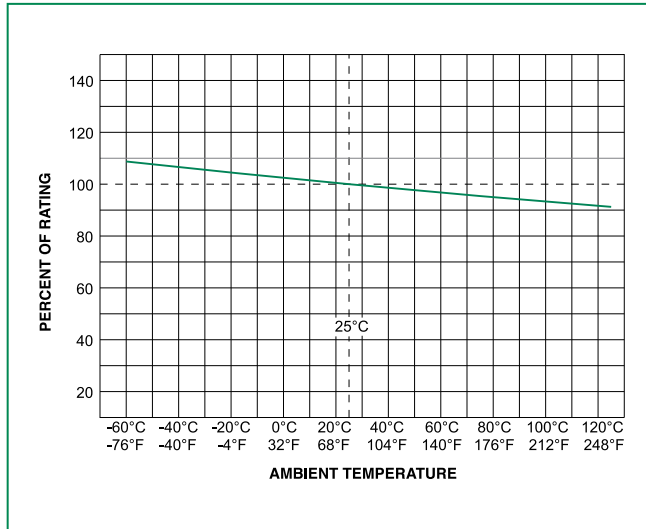

Average Time Current Curves

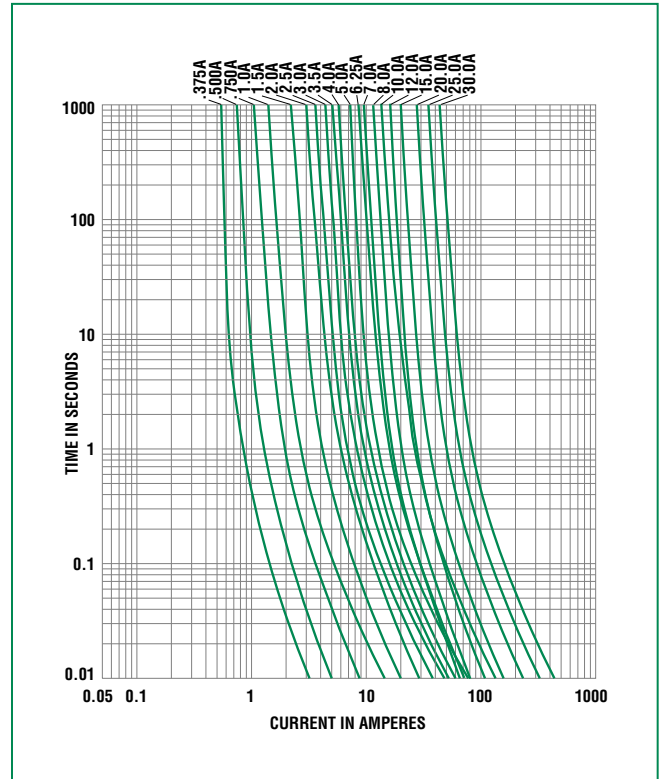

Soldering Parameters - Wave Soldering

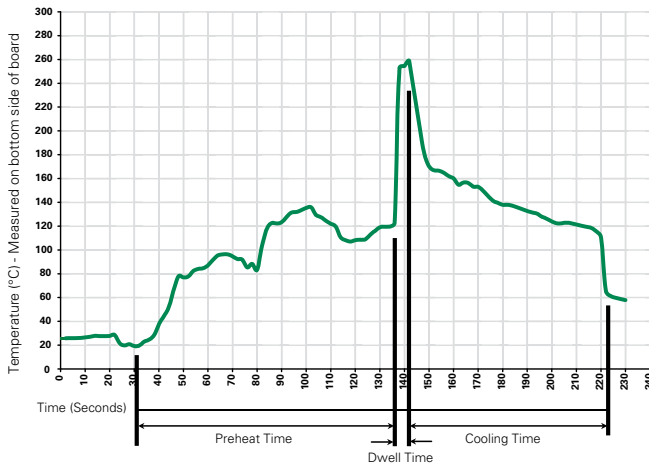

Recommended Process Parameters:

Wave Parameter	Lead-Free Recommendation
Preheat:	
(Depends on Flux Activation Temperature)	(Typical Industry Recommendation)
Temperature Minimum:	100° C
Temperature Maximum:	150° C
Preheat Time:	60-180 seconds
Solder Pot Temperature:	260° C Maximum
Solder Dwell Time:	2-5 seconds

Recommended Hand-Solder Parameters:

Solder Iron Temperature: 350° C +/- 5° C
 Heating Time: 5 seconds max.

Note: These devices are not recommended for IR or Convection Reflow process.

Product Characteristics

Materials	Body: Ceramic Cap: Nickel-plated brass Leads: Tin-plated Copper
Terminal Strength	MIL-STD-202G, Method 211A, Test Condition A
Solderability	Reference IEC 60127 Second Edition 2003-01 Annex A
Product Marking	Cap1: Brand logo, current and voltage ratings Cap2: Series and agency approval marks

Operating Temperature	-55°C to +125°C
Thermal Shock	MIL-STD-202G, Method 107G, Test Condition B:(5 cycles - 65°C to 125°C)
Vibration:	MIL-STD-202G, Method 201A
Humidity	MIL-STD-202G, Method 103B, Test Condition A: High RH (95%) and Elevated temperature(40°C) for 240 hours
Salt Spray	MIL-STD-202G, Method 101D, Test Condition B

Dimensions

326 000P Series

325 000P Series

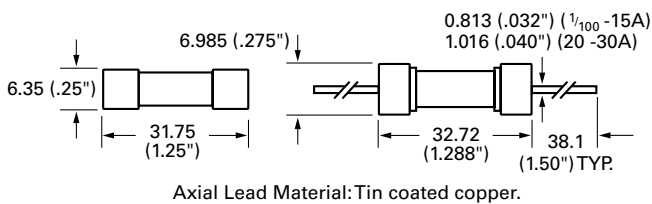

Part Numbering System

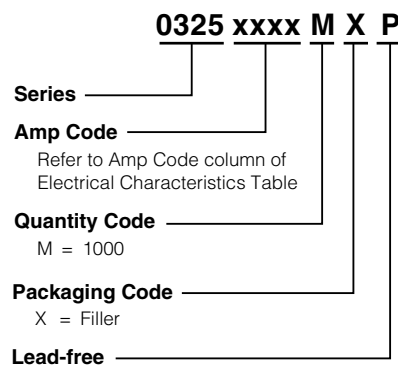

Packaging

Packaging Option	Packaging Specification	Quantity	Quantity & Packaging Code	Reel Size
325 Series				
Bulk	N/A	5	VX	N/A
Bulk	N/A	100	HX	N/A
Bulk	N/A	1000	MX	N/A
Bulk	N/A	1000	MX52	N/A
Bulk	N/A	1000	MX52L	N/A
Bulk	N/A	1000	MXD	N/A
Bulk	N/A	1000	MXF31	N/A
326 Series				
Bulk	N/A	5	VX	N/A
Bulk	N/A	100	HX	N/A
Bulk	N/A	1000	MX	N/A
Bulk	N/A	1000	MXCC	N/A
Bulk	N/A	1000	MXD	N/A