

**Agency Approvals**

| AGENCY | AGENCY FILE NUMBER |
|--------|--------------------|
|        | E230531            |

**Maximum Ratings and Thermal Characteristics**  
(T<sub>A</sub>=25°C unless otherwise noted)

| Parameter   | Symbol                            | Value      | Unit |
|---|-----------------------------------|------------|------|
| Peak Pulse Power Dissipation by 10x1000µs test waveform (Fig.1) (Note 1)              | P <sub>PPM</sub>                  | 400        | W    |
| Steady State Power Dissipation on infinite heat sink at T <sub>L</sub> =75°C (Fig. 5) | P <sub>D</sub>                    | 1.5        | W    |
| Peak Forward Surge Current, 8.3ms Single Half Sine Wave Unidirectional only (Note 2)  | I <sub>FSM</sub>                  | 40         | A    |
| Maximum Instantaneous Forward Voltage at 25A for Unidirectional only (Note 3)         | V <sub>F</sub>                    | 3.5/5.0    | V    |
| Operating Junction and Storage Temperature Range                                      | T <sub>J</sub> , T <sub>STG</sub> | -55 to 175 | °C   |
| Typical Thermal Resistance Junction to Lead   | R <sub>θJL</sub>                  | 60         | °C/W |
| Typical Thermal Resistance Junction to Ambient  | R <sub>θJA</sub>                  | 100        | °C/W |

**Notes:**

1. Non-repetitive current pulse, per Fig. 3 and derated above T<sub>A</sub> = 25°C per Fig. 2.
2. Measured on 8.3ms single half sine wave or equivalent square wave, duty cycle=4 per minute maximum.
3. V<sub>F</sub><3.5V for devices of V<sub>BR</sub>≤ 200V and V<sub>F</sub><5.0V for devices of V<sub>BR</sub> ≥ 201V.

**Description**

The P4KE Series is designed specifically to protect sensitive electronic equipment from voltage transients induced by lightning and other transient voltage events.

**Features**

- Halogen-Free
- RoHS compliant
- Typical maximum temperature coefficient  
 $\Delta V_{BR} = 0.1\% \times V_{BR} @ 25^\circ\text{C} \times \Delta T$
- Glass passivated chip junction in DO-41 Package
- 400W peak pulse capability at 10x1000µs waveform, repetition rate (duty cycles):0.01%
- Fast response time: typically less than 1.0ps from 0 Volts to BV min
- Excellent clamping capability
- Low incremental surge resistance
- Typical I<sub>R</sub> less than 1µA above 13V
- High temperature soldering guaranteed: 260°C/40 seconds / 0.375"(9.5mm) lead length, 5 lbs., (2.3kg) tension
- Plastic package has Underwriters Laboratory Flammability classification 94V-0
- Matte Tin Lead-free plated

**Applications**

TVS devices are ideal for the protection of I/O interfaces, V<sub>CC</sub> bus and other vulnerable circuits used in telecom, computer, industrial and consumer electronic applications.

### Electrical Characteristics

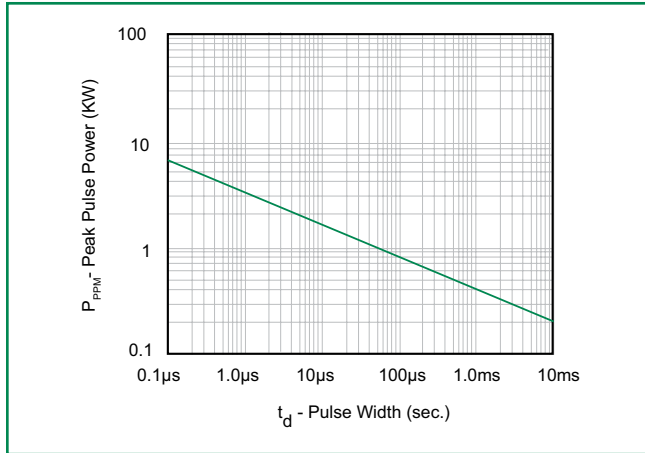
| Part Number (Uni) | Part Number (Bi) | Reverse Stand off Voltage $V_R$ (Volts) | Breakdown Voltage $V_{BR} @ I_T$ (V) |        | Test Current $I_T$ (mA) | Maximum Clamping Voltage $V_C @ I_{PP}$ (V) | Maximum Peak Pulse Current $I_{PP}$ (A) | Maximum Reverse Leakage $I_R @ V_R$ ( $\mu$ A) | Agency Approval  |
|-------------------|------------------|---|--------------------------------------|--------|-------------------------|---|---|--|---|
|                   |                  |   | MIN                                  | MAX    |                         |   |   |  |   |
| P4KE6.8A          | P4KE6.8CA        | 5.80                                    | 6.45                                 | 7.14   | 10                      | 10.5  | 39.00                                   | 1000   | X   |
| P4KE7.5A          | P4KE7.5CA        | 6.40                                    | 7.13                                 | 7.88   | 10                      | 11.3  | 36.30                                   | 500  | X   |
| P4KE8.2A          | P4KE8.2CA        | 7.02                                    | 7.79                                 | 8.61   | 10                      | 12.1  | 33.90                                   | 200  | X   |
| P4KE9.1A          | P4KE9.1CA        | 7.78                                    | 8.65                                 | 9.55   | 1                       | 13.4  | 30.60                                   | 50   | X   |
| P4KE10A           | P4KE10CA         | 8.55                                    | 9.50                                 | 10.50  | 1                       | 14.5  | 28.30                                   | 10   | X   |
| P4KE11A           | P4KE11CA         | 9.40                                    | 10.50                                | 11.60  | 1                       | 15.6  | 26.30                                   | 5  | X   |
| P4KE12A           | P4KE12CA         | 10.20                                   | 11.40                                | 12.60  | 1                       | 16.7  | 24.60                                   | 5  | X   |
| P4KE13A           | P4KE13CA         | 11.10                                   | 12.40                                | 13.70  | 1                       | 18.2  | 22.50                                   | 1  | X   |
| P4KE15A           | P4KE15CA         | 12.80                                   | 14.30                                | 15.80  | 1                       | 21.2  | 19.30                                   | 1  | X   |
| P4KE16A           | P4KE16CA         | 13.60                                   | 15.20                                | 16.80  | 1                       | 22.5  | 18.20                                   | 1  | X   |
| P4KE18A           | P4KE18CA         | 15.30                                   | 17.10                                | 18.90  | 1                       | 25.5  | 16.10                                   | 1  | X   |
| P4KE20A           | P4KE20CA         | 17.10                                   | 19.00                                | 21.00  | 1                       | 27.7  | 14.80                                   | 1  | X   |
| P4KE22A           | P4KE22CA         | 18.80                                   | 20.90                                | 23.10  | 1                       | 30.6  | 13.40                                   | 1  | X   |
| P4KE24A           | P4KE24CA         | 20.50                                   | 22.80                                | 25.20  | 1                       | 33.2  | 12.30                                   | 1  | X   |
| P4KE27A           | P4KE27CA         | 23.10                                   | 25.70                                | 28.40  | 1                       | 37.5  | 10.90                                   | 1  | X   |
| P4KE30A           | P4KE30CA         | 25.60                                   | 28.50                                | 31.50  | 1                       | 41.4  | 9.90                                    | 1  | X   |
| P4KE33A           | P4KE33CA         | 28.20                                   | 31.40                                | 34.70  | 1                       | 45.7  | 9.00                                    | 1  | X   |
| P4KE36A           | P4KE36CA         | 30.80                                   | 34.20                                | 37.80  | 1                       | 49.9  | 8.20                                    | 1  | X   |
| P4KE39A           | P4KE39CA         | 33.30                                   | 37.10                                | 41.00  | 1                       | 53.9  | 7.60                                    | 1  | X   |
| P4KE43A           | P4KE43CA         | 36.80                                   | 40.90                                | 45.20  | 1                       | 59.3  | 6.90                                    | 1  | X   |
| P4KE47A           | P4KE47CA         | 40.20                                   | 44.70                                | 49.40  | 1                       | 64.8  | 6.30                                    | 1  | X   |
| P4KE51A           | P4KE51CA         | 43.60                                   | 48.50                                | 53.60  | 1                       | 70.1  | 5.80                                    | 1  | X   |
| P4KE56A           | P4KE56CA         | 47.80                                   | 53.20                                | 58.80  | 1                       | 77.0  | 5.30                                    | 1  | X   |
| P4KE62A           | P4KE62CA         | 53.00                                   | 58.90                                | 65.10  | 1                       | 85.0  | 4.80                                    | 1  | X   |
| P4KE68A           | P4KE68CA         | 58.10                                   | 64.60                                | 71.40  | 1                       | 92.0  | 4.50                                    | 1  | X   |
| P4KE75A           | P4KE75CA         | 64.10                                   | 71.30                                | 78.80  | 1                       | 103.0                                       | 4.00                                    | 1  | X   |
| P4KE82A           | P4KE82CA         | 70.10                                   | 77.90                                | 86.10  | 1                       | 113.0                                       | 3.60                                    | 1  | X   |
| P4KE91A           | P4KE91CA         | 77.80                                   | 86.50                                | 95.50  | 1                       | 125.0                                       | 3.30                                    | 1  | X   |
| P4KE100A          | P4KE100CA        | 85.50                                   | 95.00                                | 105.00 | 1                       | 137.0                                       | 3.00                                    | 1  | X   |
| P4KE110A          | P4KE110CA        | 94.00                                   | 105.00                               | 116.00 | 1                       | 152.0                                       | 2.70                                    | 1  | X   |
| P4KE120A          | P4KE120CA        | 102.00                                  | 114.00                               | 126.00 | 1                       | 165.0                                       | 2.50                                    | 1  | X   |
| P4KE130A          | P4KE130CA        | 111.00                                  | 124.00                               | 137.00 | 1                       | 179.0                                       | 2.30                                    | 1  | X   |
| P4KE150A          | P4KE150CA        | 128.00                                  | 143.00                               | 158.00 | 1                       | 207.0                                       | 2.00                                    | 1  | X   |
| P4KE160A          | P4KE160CA        | 136.00                                  | 152.00                               | 168.00 | 1                       | 219.0                                       | 1.90                                    | 1  | X   |
| P4KE170A          | P4KE170CA        | 145.00                                  | 162.00                               | 179.00 | 1                       | 234.0                                       | 1.80                                    | 1  | X   |
| P4KE180A          | P4KE180CA        | 154.00                                  | 171.00                               | 189.00 | 1                       | 246.0                                       | 1.70                                    | 1  | X   |
| P4KE200A          | P4KE200CA        | 171.00                                  | 190.00                               | 210.00 | 1                       | 274.0                                       | 1.50                                    | 1  | X   |
| P4KE220A          | P4KE220CA        | 185.00                                  | 209.00                               | 231.00 | 1                       | 328.0                                       | 1.30                                    | 1  | X   |
| P4KE250A          | P4KE250CA        | 214.00                                  | 237.00                               | 263.00 | 1                       | 344.0                                       | 1.20                                    | 1  | X   |
| P4KE300A          | P4KE300CA        | 256.00                                  | 285.00                               | 315.00 | 1                       | 414.0                                       | 1.00                                    | 1  | X   |
| P4KE350A          | P4KE350CA        | 300.00                                  | 332.00                               | 368.00 | 1                       | 482.0                                       | 0.85                                    | 1  | X   |
| P4KE400A          | P4KE400CA        | 342.00                                  | 380.00                               | 420.00 | 1                       | 548.0                                       | 0.75                                    | 1  | X   |
| P4KE440A          | P4KE440CA        | 376.00                                  | 418.00                               | 462.00 | 1                       | 602.0                                       | 0.68                                    | 1  | X   |
| P4KE480A          | P4KE480CA        | 408.00                                  | 456.00                               | 504.00 | 1                       | 658.0                                       | 0.61                                    | 1  | X   |
| P4KE510A          | P4KE510CA        | 434.00                                  | 485.00                               | 535.00 | 1                       | 698.0                                       | 0.57                                    | 1  | X   |
| P4KE530A          | P4KE530CA        | 477.00                                  | 503.50                               | 556.50 | 1                       | 725.0                                       | 0.55                                    | 1  | X   |
| P4KE540A          | P4KE540CA        | 486.00                                  | 513.00                               | 567.00 | 1                       | 740.0                                       | 0.54                                    | 1  | X   |
| P4KE550A          | P4KE550CA        | 495.00                                  | 522.50                               | 577.50 | 1                       | 760.0                                       | 0.52                                    | 1  | X   |

For bidirectional type having  $V_R$  of 10 volts and less, the  $I_R$  limit is double.

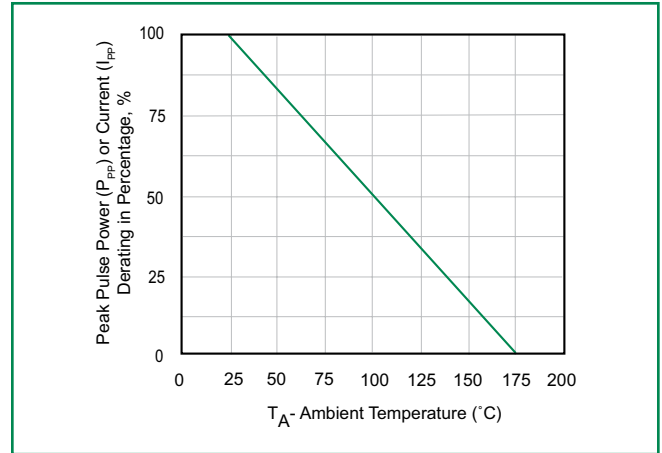
For parts without A, the  $V_{BR}$  is  $\pm 10\%$  and  $V_C$  is 5% higher than with A parts

### Ratings and Characteristic Curves ( $T_A=25^\circ\text{C}$ unless otherwise noted)

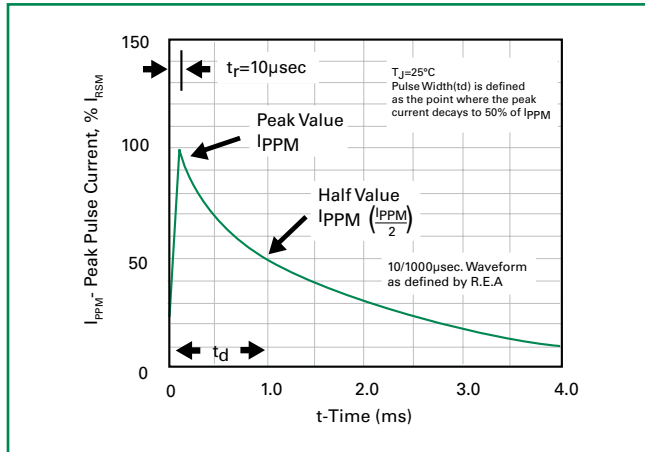
**Figure 1 - Peak Pulse Power Rating**



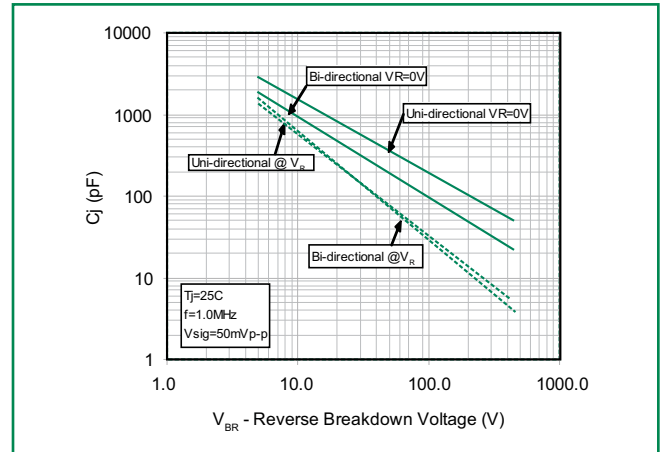
**Figure 2 - Pulse Derating Curve**



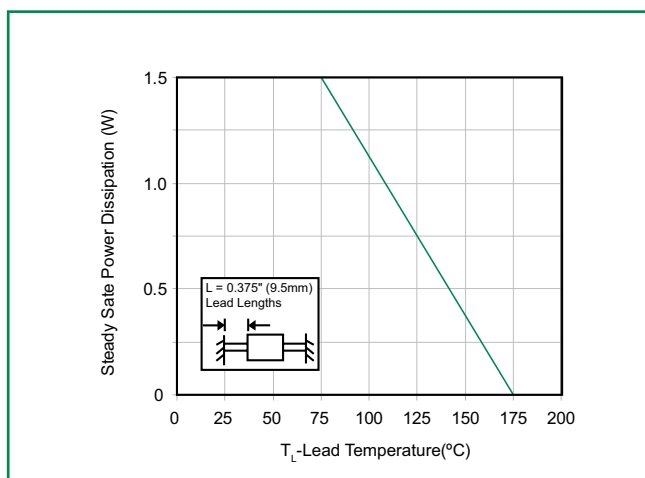
**Figure 3 - Pulse Waveform**



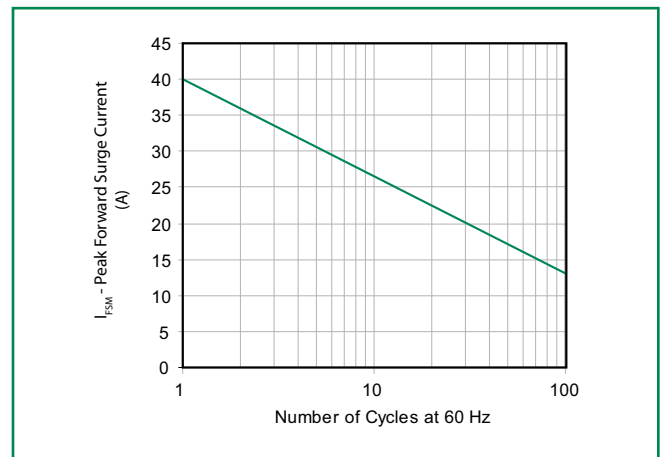
**Figure 4 - Typical Junction Capacitance Uni-Directional**



**Figure 5 - Steady Pulse Derating Curve**

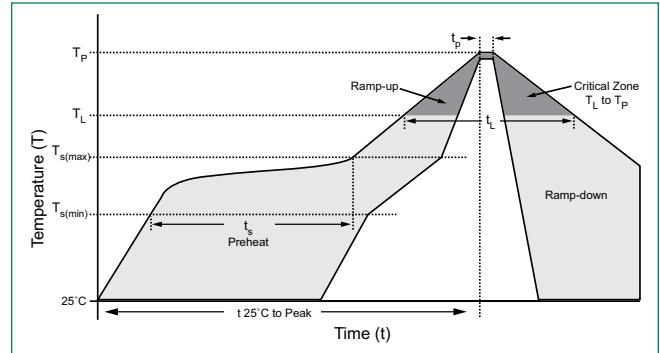


**Figure 6 - Maximum Non-Repetitive Peak Forward Surge Current Uni-Directional Only**



### Soldering Parameters

|  |                                    |                         |
|--|------------------------------------|-------------------------|
| Reflow Condition                                       |                                    | Lead-free assembly      |
| Pre Heat   | - Temperature Min ( $T_{s(min)}$ ) | 150°C                   |
|  | - Temperature Max ( $T_{s(max)}$ ) | 200°C                   |
|  | - Time (min to max) ( $t_s$ )      | 60 – 180 secs           |
| Average ramp up rate (Liquidus Temp ( $T_L$ ) to peak) |                                    | 3°C/second max          |
| $T_{s(max)}$ to $T_L$ - Ramp-up Rate                   |                                    | 3°C/second max          |
| Reflow   | - Temperature ( $T_L$ ) (Liquidus) | 217°C                   |
|  | - Time (min to max) ( $t_s$ )      | 60 – 150 seconds        |
| Peak Temperature ( $T_p$ )                             |                                    | 260 <sup>+0/-5</sup> °C |
| Time within 5°C of actual peak Temperature ( $t_p$ )   |                                    | 20 – 40 seconds         |
| Ramp-down Rate   |                                    | 6°C/second max          |
| Time 25°C to peak Temperature ( $T_p$ )                |                                    | 8 minutes Max.          |
| Do not exceed  |                                    | 280°C                   |



### Flow/Wave Soldering (Solder Dipping)

|                           |           |
|---------------------------|-----------|
| <b>Peak Temperature :</b> | 260°C     |
| <b>Dipping Time :</b>     | 5 seconds |
| <b>Soldering :</b>        | 1 time    |

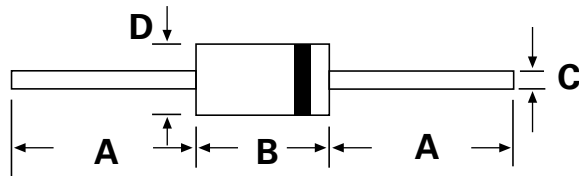
### Physical Specifications

|                 |  |
|-----------------|--|
| <b>Weight</b>   | 0.012oz., 0.3g   |
| <b>Case</b>     | JEDEC DO-204AL (DO-41) molded plastic body over passivated junction. |
| <b>Polarity</b> | Color band denotes the cathode except Bipolar.                       |
| <b>Terminal</b> | Matte Tin axial leads, solderable per JESD22-B102D.                  |

### Environmental Specifications

|                           |              |
|---------------------------|--------------|
| <b>Temperature Cycle</b>  | JESD22-A104  |
| <b>Pressure Cooker</b>    | JESD 22-A102 |
| <b>High Temp. Storage</b> | JESD22-A103  |
| <b>HTRB</b>               | JESD22-A108  |
| <b>Thermal Shock</b>      | JESD22-A106  |

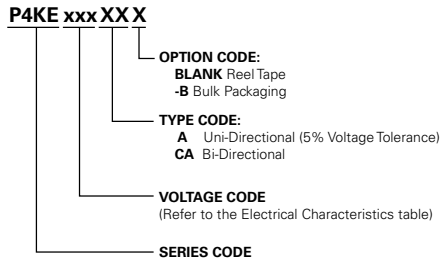
### Dimensions



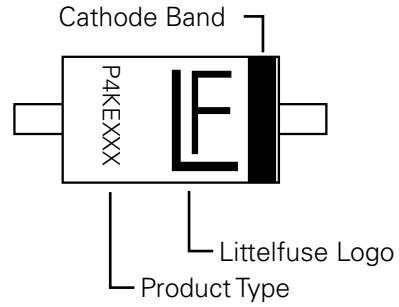
DO-204AL (DO-41)

| Dimensions | Inches |       | Millimeters |      |
|------------|--------|-------|-------------|------|
|            | Min    | Max   | Min         | Max  |
| A          | 1.000  | -     | 25.40       | -    |
| B          | 0.160  | 0.205 | 4.10        | 5.20 |
| C          | 0.028  | 0.034 | 0.71        | 0.86 |
| D          | 0.080  | 0.107 | 2.00        | 2.70 |

### Part Numbering System



### Part Marking System



### Packaging

| Part Number | Component Package | Quantity | Packaging Option | Packaging Specification                  |
|-------------|-------------------|----------|------------------|--|
| P4KExxxXX   | DO-204AL          | 5000     | Tape & Reel      | EIA STD RS-296E                          |
| P4KExxxXX-B | DO-204AL          | 500      | BOX              | Littelfuse Concord Packing Spec. DM-0016 |