

SMAJ Series

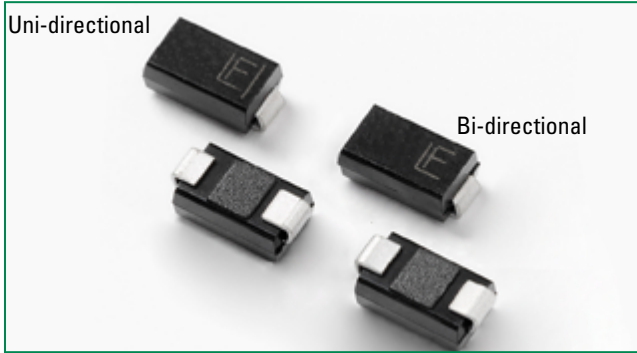

Agency Approvals

AGENCY	AGENCY FILE NUMBER
	E230531

Maximum Ratings and Thermal Characteristics (T_A = 25°C unless otherwise noted)

Parameter	Symbol	Value	Unit
Peak Pulse Power Dissipation at T _A = 25°C by 10/1000µs Waveform (Fig.2)(Note 1), (Note 2), (Note 5)	P _{PPM}	400	W
Power Dissipation on Infinite Heat Sink at T _L = 50°C	P _D	3.3	W
Peak Forward Surge Current, 8.3ms Single Half Sine Wave (Note 3)	I _{FSM}	60	A
Maximum Instantaneous Forward Voltage at 25A for Unidirectional Only (Note 4)	V _F	3.5/5.0	V
Operating Temperature Range	T _J	-65 to 150	°C
Storage Temperature Range	T _{STG}	-65 to 175	°C
Typical Thermal Resistance Junction to Lead	R _{θJL}	30	°C/W
Typical Thermal Resistance Junction to Ambient	R _{θJA}	120	°C/W

- Notes:**
1. Non-repetitive current pulse, per Fig.4 and derated above T_J (initial) = 25°C per Fig. 3.
 2. Mounted on 5.0x5.0mm copper pad to each terminal.
 3. Measured on 8.3ms single half sine wave or equivalent square wave for unidirectional device only.
 4. V_F < 3.5V for single die parts and V_F < 5.0V for stacked-die parts.
 5. The P_{PPM} of stacked-die parts is 600W and please contact littelfuse for the detail stacked-die parts.

Functional Diagram

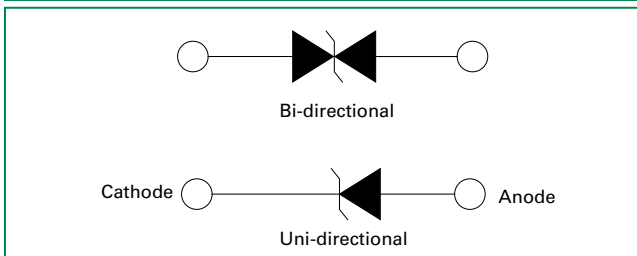

Description

The SMAJ series is designed specifically to protect sensitive electronic equipment from voltage transients induced by lightning and other transient voltage events.

Features

- 400W Peak pulse power capability at 10/1000µs waveform, repetition rate (duty cycle): 0.01%
- Excellent clamping capability
- Typical I_R less than 1µA when V_{BR} min > 12V
- For surface mounted applications to optimize board space
- Low profile package
- Typical failure mode is short from over-specified voltage or current
- Whisker test is conducted based on JEDEC JESD201A per its table 4a and 4c
- IEC-61000-4-2 ESD 30kV(Air), 30kV (Contact)
- ESD protection of data lines in accordance with IEC 61000-4-2
- EFT protection of data lines in accordance with IEC 61000-4-4
- Built-in strain relief
- Fast response time: typically less than 1.0ps from 0 Volts to V_{BR} min
- Glass passivated junction
- Low inductance
- High temperature to reflow soldering guaranteed: 260°C/40sec
- V_{BR} @ T_J = V_{BR} @ 25°C x (1 + α T x (T_J - 25)) (α T: Temperature Coefficient, typical value is 0.1%)
- Plastic package is flammability rated V-0 per Underwriters Laboratories
- Meet MSL level1, per J-STD-020, LF maximum peak of 260°C
- Matte tin lead-free Plated
- Halogen free and RoHS compliant
- Pb-free E3 means 2nd level interconnect is Pb-free and the terminal finish material is tin(Sn) (IPC/JEDEC J-STD-609A.01)

Applications

TVS devices are ideal for the protection of I/O Interfaces, V_{CC} bus and other vulnerable circuits used in Telecom, Computer, Industrial and Consumer electronic applications.

Additional Information



Transient Voltage Suppression Diodes

Surface Mount – 400W > SMAJ series

Electrical Characteristics (T_A = 25°C unless otherwise noted)

Part Number (Uni)	Part Number (Bi)	Marking		Reverse Stand off Voltage V _R (Volts)	Breakdown Voltage V _{BR} (Volts) @ I _T		Test Current I _T (mA)	Maximum Clamping Voltage V _C @ I _{pp} (V)	Maximum Peak Pulse Current I _{pp} (A)	Maximum Reverse Leakage I _R @ V _R (μA)	Agency Approval 
		UNI	BI		MIN	MAX					
SMAJ5.0A	SMAJ5.0CA	AE	WE	5.0	6.40	7.00	10	9.2	43.5	800	X
SMAJ6.0A	SMAJ6.0CA	AG	WG	6.0	6.67	7.37	10	10.3	38.8	800	X
SMAJ6.5A	SMAJ6.5CA	AK	WK	6.5	7.22	7.98	10	11.2	35.7	500	X
SMAJ7.0A	SMAJ7.0CA	AM	WM	7.0	7.78	8.60	10	12.0	33.3	200	X
SMAJ7.5A	SMAJ7.5CA	AP	WP	7.5	8.33	9.21	1	12.9	31.0	100	X
SMAJ8.0A	SMAJ8.0CA	AR	WR	8.0	8.89	9.83	1	13.6	29.4	50	X
SMAJ8.5A	SMAJ8.5CA	AT	WT	8.5	9.44	10.40	1	14.4	27.8	20	X
SMAJ9.0A	SMAJ9.0CA	AV	VW	9.0	10.00	11.10	1	15.4	26.0	10	X
SMAJ10A	SMAJ10CA	AX	WX	10.0	11.10	12.30	1	17.0	23.5	5	X
SMAJ11A	SMAJ11CA	AZ	VZ	11.0	12.20	13.50	1	18.2	22.0	1	X
SMAJ12A	SMAJ12CA	BE	XE	12.0	13.30	14.70	1	19.9	20.1	1	X
SMAJ13A	SMAJ13CA	BG	XG	13.0	14.40	15.90	1	21.5	18.6	1	X
SMAJ14A	SMAJ14CA	BK	XK	14.0	15.60	17.20	1	23.2	17.2	1	X
SMAJ15A	SMAJ15CA	BM	XM	15.0	16.70	18.50	1	24.4	16.4	1	X
SMAJ16A	SMAJ16CA	BP	XP	16.0	17.80	19.70	1	26.0	15.4	1	X
SMAJ17A	SMAJ17CA	BR	XR	17.0	18.90	20.90	1	27.6	14.5	1	X
SMAJ18A	SMAJ18CA	BT	XT	18.0	20.00	22.10	1	29.2	13.7	1	X
SMAJ20A	SMAJ20CA	BV	XV	20.0	22.20	24.50	1	32.4	12.3	1	X
SMAJ22A	SMAJ22CA	BX	XX	22.0	24.40	26.90	1	35.5	11.3	1	X
SMAJ24A	SMAJ24CA	BZ	XZ	24.0	26.70	29.50	1	38.9	10.3	1	X
SMAJ26A	SMAJ26CA	CE	YE	26.0	28.90	31.90	1	42.1	9.5	1	X
SMAJ28A	SMAJ28CA	CG	YG	28.0	31.10	34.40	1	45.4	8.8	1	X
SMAJ30A	SMAJ30CA	CK	YK	30.0	33.30	36.80	1	48.4	8.3	1	X
SMAJ33A	SMAJ33CA	CM	YM	33.0	36.70	40.60	1	53.3	7.5	1	X
SMAJ36A	SMAJ36CA	CP	YP	36.0	40.00	44.20	1	58.1	6.9	1	X
SMAJ40A	SMAJ40CA	CR	YR	40.0	44.40	49.10	1	64.5	6.2	1	X
SMAJ43A	SMAJ43CA	CT	YT	43.0	47.80	52.80	1	69.4	5.8	1	X
SMAJ45A	SMAJ45CA	CV	YV	45.0	50.00	55.30	1	72.7	5.5	1	X
SMAJ48A	SMAJ48CA	CX	YX	48.0	53.30	58.90	1	77.4	5.2	1	X
SMAJ51A	SMAJ51CA	CZ	YZ	51.0	56.70	62.70	1	82.4	4.9	1	X
SMAJ54A	SMAJ54CA	RE	ZE	54.0	60.00	66.30	1	87.1	4.6	1	X
SMAJ58A	SMAJ58CA	RG	ZG	58.0	64.40	71.20	1	93.6	4.3	1	X
SMAJ60A	SMAJ60CA	RK	ZK	60.0	66.70	73.70	1	96.8	4.1	1	X
SMAJ64A	SMAJ64CA	RM	ZM	64.0	71.10	78.60	1	103.0	3.9	1	X
SMAJ70A	SMAJ70CA	RP	ZP	70.0	77.80	86.00	1	113.0	3.5	1	X
SMAJ75A	SMAJ75CA	RR	ZR	75.0	83.30	92.10	1	121.0	3.3	1	X
SMAJ78A	SMAJ78CA	RT	ZT	78.0	86.70	95.80	1	126.0	3.2	1	X
SMAJ85A	SMAJ85CA	RV	ZV	85.0	94.40	104.00	1	137.0	2.9	1	X
SMAJ90A	SMAJ90CA	RX	ZX	90.0	100.00	111.00	1	146.0	2.7	1	X
SMAJ100A	SMAJ100CA	RZ	ZZ	100.0	111.00	123.00	1	162.0	2.5	1	X
SMAJ110A	SMAJ110CA	SE	VE	110.0	122.00	135.00	1	177.0	2.3	1	X
SMAJ120A	SMAJ120CA	SG	VG	120.0	133.00	147.00	1	193.0	2.1	1	X
SMAJ130A	SMAJ130CA	SK	VK	130.0	144.00	159.00	1	209.0	1.9	1	X
SMAJ150A	SMAJ150CA	SM	VM	150.0	167.00	185.00	1	243.0	1.6	1	X
SMAJ160A	SMAJ160CA	SP	VP	160.0	178.00	197.00	1	259.0	1.5	1	X
SMAJ170A	SMAJ170CA	SR	VR	170.0	189.00	209.00	1	275.0	1.5	1	X
SMAJ180A	SMAJ180CA	ST	VT	180.0	201.00	222.00	1	292.0	1.4	1	X
SMAJ200A	SMAJ200CA	SV	VV	200.0	224.00	247.00	1	324.0	1.2	1	X
SMAJ220A	SMAJ220CA	SX	VX	220.0	246.00	272.00	1	356.0	1.1	1	X
SMAJ250A	SMAJ250CA	SZ	VZ	250.0	279.00	309.00	1	405.0	1.0	1	X
SMAJ300A	SMAJ300CA	TE	UE	300.0	335.00	371.00	1	486.0	0.8	1	X
SMAJ350A	SMAJ350CA	TG	UG	350.0	391.00	432.00	1	567.0	0.7	1	X
SMAJ400A	SMAJ400CA	TK	UK	400.0	447.00	494.00	1	648.0	0.6	1	X
SMAJ440A	SMAJ440CA	TM	UM	440.0	492.00	543.00	1	713.0	0.6	1	X

For bidirectional type having V_R of 10 volts and less, the I_R limit is double.
 For parts without A, the V_{BR} is ± 10% and V_C is 5% higher than with A parts
 © 2015 Littelfuse, Inc.
 Specifications are subject to change without notice.
 Revised: 11/20/15

I-V Curve Characteristics

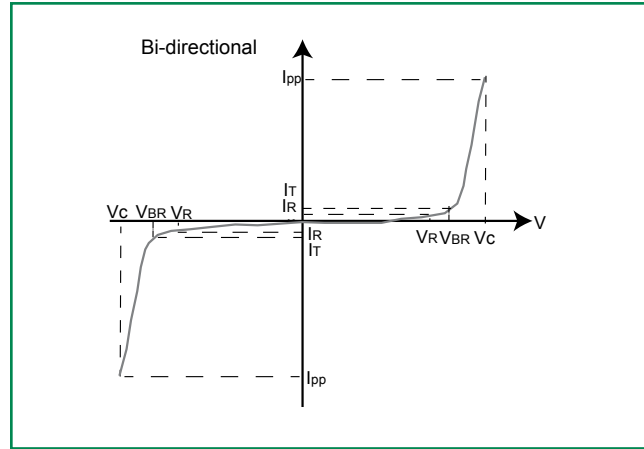
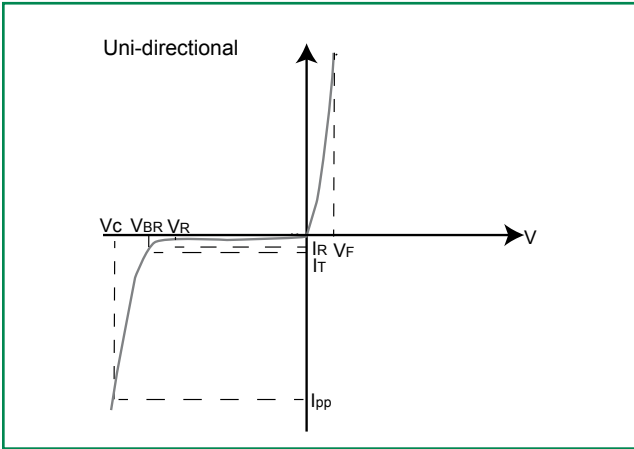

- P_{PPM} Peak Pulse Power Dissipation** – Max power dissipation
- V_R Stand-off Voltage** – Maximum voltage that can be applied to the TVS without operation
- V_{BR} Breakdown Voltage** – Maximum voltage that flows through the TVS at a specified test current (I_R)
- V_C Clamping Voltage** – Peak voltage measured across the TVS at a specified I_{ppm} (peak impulse current)
- I_R Reverse Leakage Current** – Current measured at V_R
- V_F Forward Voltage Drop for Uni-directional**

Ratings and Characteristic Curves ($T_A=25^\circ\text{C}$ unless otherwise noted)

Figure 1 - TVS Transients Clamping Waveform

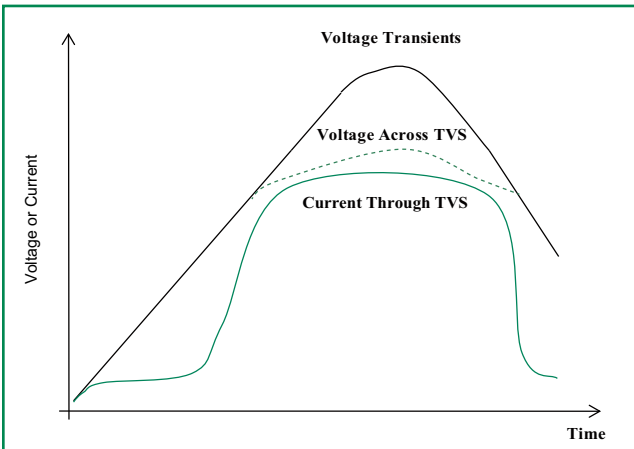
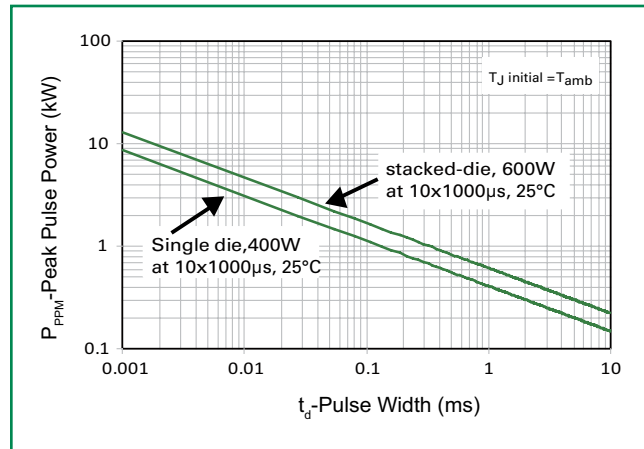

Figure 2 - Peak Pulse Power Rating Curve



continues on next page.

Ratings and Characteristic Curves ($T_A=25^\circ\text{C}$ unless otherwise noted) (Continued)

Figure 3 - Peak Pulse Power Derating Curve

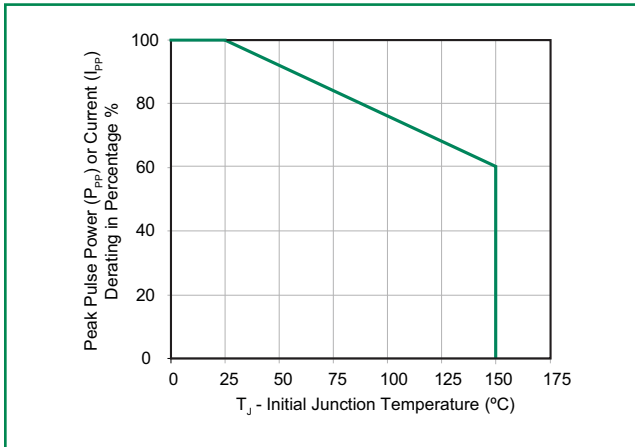

Figure 4 - Pulse Waveform

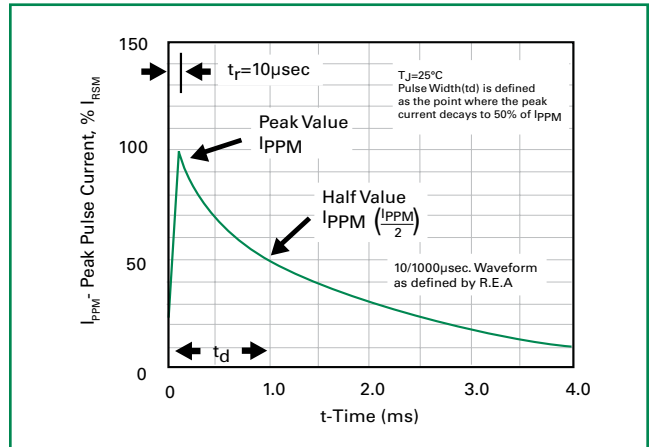

Figure 5 - Typical Junction Capacitance

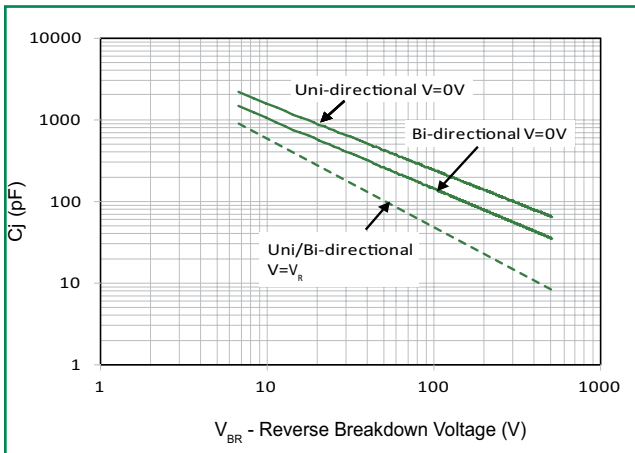

Figure 6 - Typical Transient Thermal Impedance

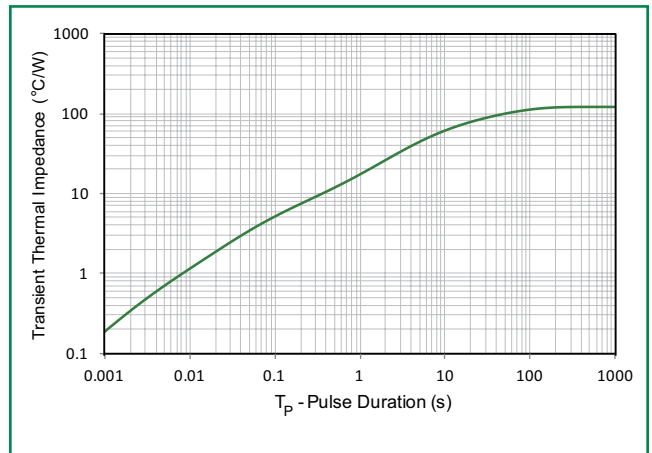

Figure 7 - Maximum Non-Repetitive Forward Surge Current Uni-Directional Only

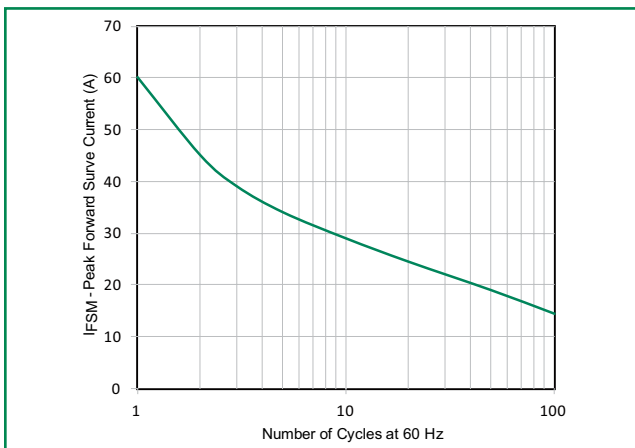
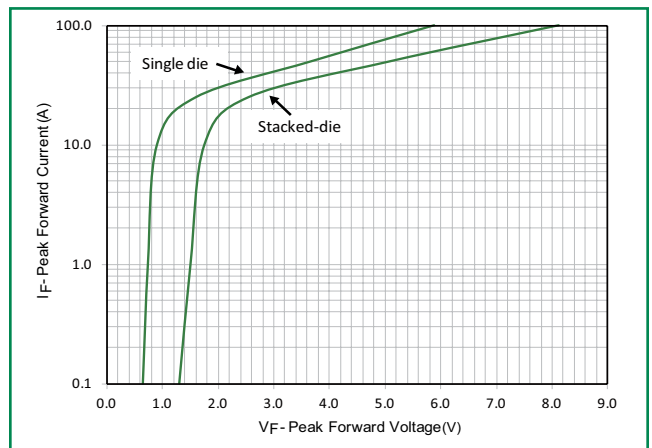
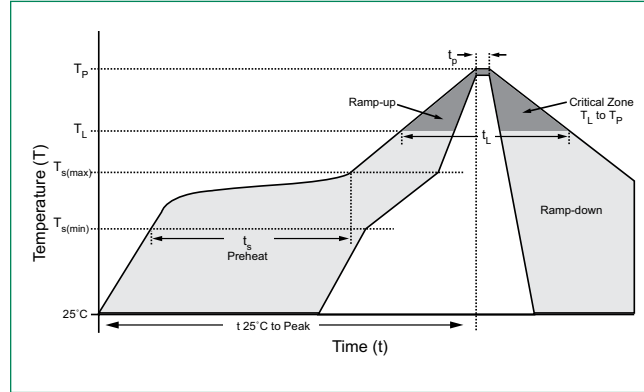

Figure 8 - Peak Forward Voltage Drop vs Peak Forward Current (Typical Values)



Soldering Parameters

Reflow Condition		Lead-free assembly
Pre Heat	- Temperature Min ($T_{s(min)}$)	150°C
	- Temperature Max ($T_{s(max)}$)	200°C
	- Time (min to max) (t_s)	60 – 180 secs
Average ramp up rate (Liquidus Temp (T_A) to peak)		3°C/second max
$T_{s(max)}$ to T_A - Ramp-up Rate		3°C/second max
Reflow	- Temperature (T_A) (Liquidus)	217°C
	- Time (min to max) (t_s)	60 – 150 seconds
Peak Temperature (T_p)		260 ^{+0/-5} °C
Time within 5°C of actual peak Temperature (t_p)		20 – 40 seconds
Ramp-down Rate		6°C/second max
Time 25°C to peak Temperature (T_p)		8 minutes Max.
Do not exceed		260°C



Physical Specifications

Weight	0.002 ounce, 0.061 gram
Case	JEDEC DO-214AC Molded Plastic over glass passivated junction
Polarity	Color band denotes cathode except Bipolar
Terminal	Matte Tin-plated leads, Solderable per JESD22-B102

Environmental Specifications

High Temp. Storage	JESD22-A103
HTRB	JESD22-A108
Temperature Cycling	JESD22-A104
MSL	JEDEC-J-STD-020, Level 1
H3TRB	JESD22-A101
RSH	JESD22-A111

Dimensions

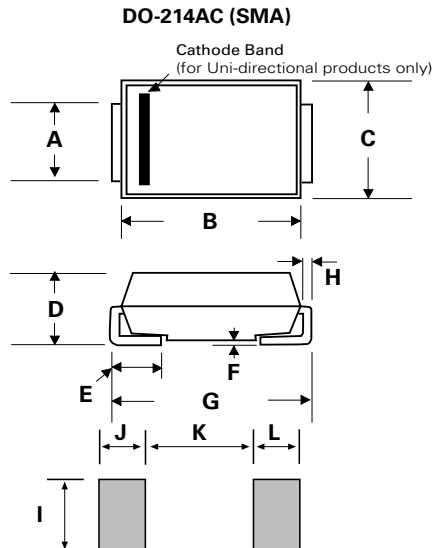

Dimensions	Inches		Millimeters	
	Min	Max	Min	Max
A	0.049	0.065	1.250	1.650
B	0.157	0.181	3.990	4.600
C	0.095	0.110	2.400	2.790
D	0.075	0.090	1.900	2.290
E	0.030	0.060	0.780	1.520
F	-	0.008	-	0.203
G	0.189	0.208	4.800	5.280
H	0.006	0.012	0.152	0.305
I	0.070	-	1.800	-
J	0.082	-	2.100	-
K	-	0.090	-	2.300
L	0.082	-	2.100	-

Part Numbering System

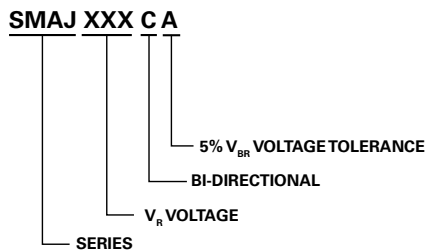

Part Marking System

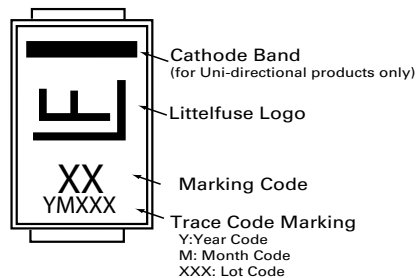

Packaging

Part number	Component Package	Quantity	Packaging Option	Packaging Specification
SMAJ-xxxXX	DO-214AC	5000	Tape & Reel - 12mm tape/13" reel	EIA STD RS-481

Tape and Reel Specification

